

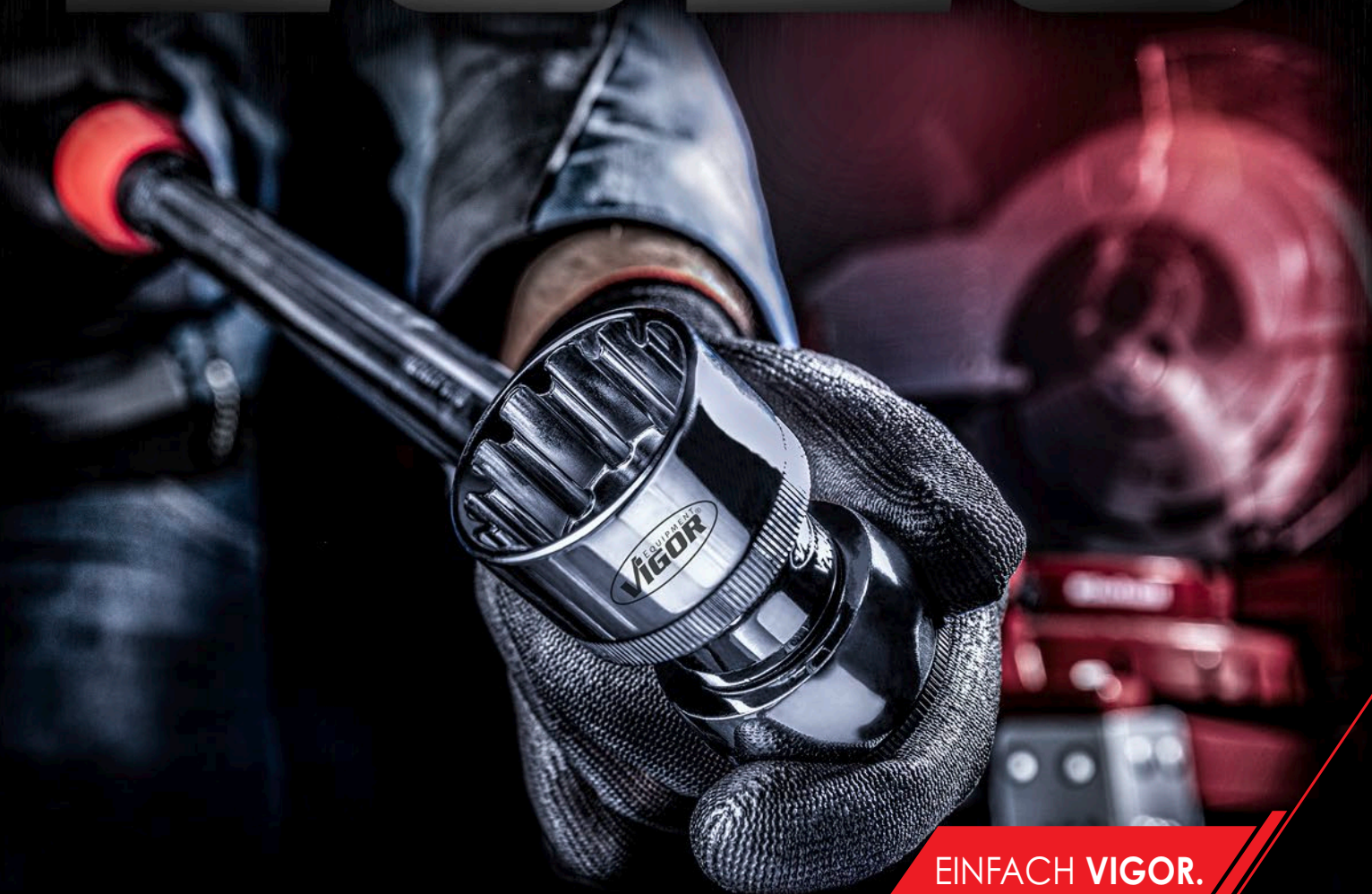

TOOL CATALOGUE 2020



EINFACH VIGOR.





The time is ripe!

Are you ready for a brand with an unbeatable value for money? Are you ready for a brand full of dynamism, heart and soul, quality and service?

Then you've come exactly to the right place!

Since our foundation in 2006 in the tool-making city of Remscheid, quality products at the best prices for our customers have been the focus of our attention in our portfolio. We place great emphasis on accessibility, proximity and service because our customer is king!

We at VIGOR recognise your high standards and are actively engaged in finding efficient solutions and in constant communication with established trading partners, industrial enterprises and automobile workshops in order to always operate in tune with the times.

The flexibility of our committed employees allows us to offer you the best. Our product portfolio is thus constantly aligned and expanded so that we can move according to the market.

In addition to our products, we also offer a spectrum of possibilities that allows you to benefit from our brand. You are a social media expert? Then experience our brand world on Instagram. You would like to receive advice in person? Then visit us at the trade fairs in your area and let our trade fair stand convince you. You want men who are experts? Then benefit from our technical customer service advisors right at your doorstep. You want the full range? Then immerse yourself in our online world and visit our brand new website with helpful tutorials, our product portfolio and the latest offers.

Team VIGOR



	Tool trolleys and factory equipment	→ 34–91
	Tool storage	→ 92–129
	Hand tools	→ 130–235
	Torque tools	→ 236–241
	Pneumatic tools	→ 242–249
	General workshop tools	→ 250–261
	Diagnostics / Battery / Electrical System	→ 262–266
	Engine / Radiator / A/C	→ 267–291
	Oil service	→ 292–299
	Brakes	→ 300–317
	Wheels / tyres	→ 318–329
	Car body	→ 330–335
	Motor / commercial vehicle chassis specialty tools	→ 342–415

Table of Contents



Tool trolleys with assortment	37–49	Accessories for tool trolleys	61–71	
Mobile work benches with assortment	50–51	Work benches, tool cabinets, accessories	72–75	
Service trolley	52	Wall unit systems	76–88	
Tool trolleys without assortment	53–59	Accessories for wall unit systems	89–91	
Mobile work bench without assortment	60			
<hr/>				
Multiboxes	94– 97			
Soft foam inserts	98–129			
<hr/>				
Sockets	132–181	VDE tools	216–219	
Universal tool cases	182–183	Impact and releasing tools, scrapers	220–226	
Wrenches	184–194	Various hand tools	227	
Screwdrivers and bits	195–203	Cutting and sawing	228–235	
Pliers	204–215			
<hr/>				
T-handle torque screwdriver	238			
Torque wrenches	239–240			
Rotation angle tester	241			
<hr/>				
Impact wrenches	244–245			
Air ratchets	246			
Die grinder	247			
Sanders / Drills	248			
Pneumatic guns	249			
<hr/>				
Electrical system	263			
Multimeter and measuring cable sets	263–264			
Cable release tools	265			
Crimping pliers set	266			
<hr/>				
Engine tools	268–271			
Injector sealing seat cleaning	272			
Engine firing tools	273–283			
Cooling system diagnostics	284–287			
Turbo system diagnostics	288–289			
Compression and pressure loss testers	290–291			
<hr/>				
Oil dipsticks	294			
Oil filter wrenches	295–296			
Oil pumps and filling devices	297–299			
<hr/>				
Brake maintenance and bleeding	302–305			
Brake piston readjusting tools	306–308			
Brake discs tools	309			
Tube flaring tools	310–313			
Inspection tools	314–317			
<hr/>				
Impact sockets	319–321			
Service jacks and jack stands	322–324			
Wheel/tyre tools	325–329			
<hr/>				
Wiper arm puller set	331			
Window pane holder	332			
Repair and installation sets	333			
Induction heater and accessories	334–335			
<hr/>				
Motor vehicles chassis – Various	336–341	Standard wheel bearing tool sets	354–356	Bearing and bushing tool sets
Tractive and compressive cylinders	344–346	Compact wheel bearing tool sets	357	Safety spring vice
Cylinder accessories	347–350	Screwed compact wheel bearing tool sets	358–364	Mobile work benches with specialty tool assortment
Mechanical drive	351–352	Wheel hub tool sets with 6 and 8 bolts	365	Special soft foam inserts
	376–378	Drive shaft tool sets	366	Commercial vehicle tool sets
Hydraulic pumps	353	Multiboxes	367–375	



Description of drive symbols

	For slotted screws
	For Phillips-Recess screws (PH)
	For Poizidriv screws (PZ)
	For inside hexagon screws
	For outside hexagon screws
	For inside TORX ® screws
	For tamper resistant TORX ® screws (inside TORX ® screws with pin)
	For outside TORX ® screws
	For screws with internal serration XZN
	For spline socket screws RIBE CV
	For Polydrive screws
	For inside 5-star screws with centre pin
	For Tri-Wing® screws
	Nominal size 6.3 mm
	Nominal size 10 mm
	Nominal size 12.5 mm
	Nominal size 20 mm
	Nominal size 25 mm
	Inside square
	Outside square
	Inside hexagon
	Outside hexagon
	EN/IEC 60900:2004

Description of icons

	Tools for motor vehicles
	Tools for trucks
	Operating instructions/Application note
	Central locking
	Weight of tool trolley
	Loading capacity of tool trolley
	Number of pieces
	Teeth
	Rotation angle
	Bore holes
	Shafts
	Magnet
	Operating time
	Charging time
	Weight
	Battery type
	Audible signal
	Working pressure
	Vibration
	rpm
	Sound level
	Max. loosening torque
	Twin hammer mechanism
	Coupler plug, nominal size
	Battery type
	Test equipment
	SUV/Van
	Agricultural machinery
	Industry
	QR Code
	Application video
	Hose length
	Oil capacity
	Hydraulic working
	Mechanical working



Alphabetical index of key words



A

Adapter / connection piece..... 138–139, 152–153, 168–169, 173, 176,
..... 285, 288, 295, 303, 348–349, 378, 393
Air blow gun..... 249
Air ratchet / air-operated power wrench..... 246, 321
Assembly trolley..... 37–49, 53–59, 61–63, 66–71, 74, 396
Assortment / set..... 99–100, 102–111, 113–118, 126–128, 133–134,
..... 143, 156, 159, 172–173, 176–181, 188, 192, 195–197,
..... 199–201, 207, 211, 216, 218, 222–223, 226–227, 234,
..... 253–255, 260, 266, 268, 270–281, 284, 287–288, 294,
..... 298, 302, 304–305, 312–313, 316, 320–321, 324, 326,
..... 331–333, 337, 347, 351, 355–360, 363, 367, 371–376, 378,
..... 387–389, 391, 400–403, 405–407, 409–410, 412–415

B

Balance weight pliers..... 326
Balance weight tool..... 326
Ball joint puller..... 385, 388, 404
Bits and screwdrivers..... 94, 103–104, 109, 112–113, 115–117,
..... 127, 135, 139–141, 147–153, 156–158, 164–167,
..... 169, 178, 195–203, 217–218, 238, 296
Black Edition..... 37–38
Block and bushings tool..... 370, 374, 379–392, 402, 413
Bottle jack..... 323
Box-end wrench..... 102–103, 115, 186–187, 189–193
Brush..... 222, 225, 231–233, 260, 352

C

Cable release tools..... 265
Can holder..... 63
Cape chisel..... 221, 224
Car body tools..... 331–335
Car light tester..... 263
Cardan shaft puller..... 340
Carpet knife..... 229
Case..... 94–97, 178, 182–183, 367–368, 371–375
Centre punch..... 221, 224
Chassis tool..... 119, 312, 315, 319–320, 325–328,
..... 336–338, 340, 354–368, 371–384,
..... 386–393, 400–403, 405–411, 413
Chisel..... 95, 99, 106, 109, 118–119, 127, 221
Circlip pliers..... 105, 206–210, 212, 271, 352
Clamping screw tool..... 337
Club hammer..... 220
Cockpit retaining plate..... 73
Combination pliers..... 204, 219
Combination spanner..... 102, 113–115, 128
Combination wrench..... 102, 113–115, 121, 128, 185–186
Compact wheel bearing tool..... 357, 359–364, 368–369,
..... 371–373, 402–403
Compression and engine leakage tester..... 290–291
Compressive hydraulic cylinder..... 344–347, 375, 400, 402
Connection piece / adapter..... 125, 138–139, 152–153, 168–169, 173,
..... 176, 285, 288, 295, 303, 348–350, 378, 393
Cooling system diagnostics..... 284–286
Corner base cabinet..... 87
Crimping pliers..... 266
Cross recess (PH) tool..... 141, 147, 195–196, 218
Cutting knife..... 229

D

Depth gauge..... 327
Diagnostics..... 218, 227, 238–241, 263–264,
..... 284–288, 290–291, 294, 309, 315, 327
Diagonal cutter..... 204, 213, 219
Die grinder..... 247
Double box-end wrench..... 102, 186–187, 191, 193
Double open-end wrench..... 102, 184
Double ratcheting box-end wrench..... 193
Double-joint pliers..... 105, 204–206
Drawer..... 68–69
Drawer separation sheet..... 64–66
Drift pin..... 99, 119, 221, 223
Drift punch..... 99, 119, 221, 223
Drill..... 234
Drive shaft tools..... 355, 364, 366, 375–378,
..... 384, 401–402, 406–411
Drive-out pin..... 119, 221, 223

E

Engine leakage / compression tester..... 290–291
Extension..... 115, 137–138, 154, 169, 174–175, 217
Extractor socket with spiral profile..... 159, 171

F

Feeler gauge..... 227
File..... 106, 230, 315
Fine tooth ratchet..... 135–136, 145, 162, 177
Finger ratchet..... 135
Fixed castor..... 52, 67
Flat chisel..... 221, 223
Flat wrench..... 113
Flexible / wobble extension..... 137–138, 154, 169
Flexible handle..... 162, 174
Flexible handle ratchet..... 174
Flexible screwdriver..... 198
Foam mat..... 71
Forceps..... 254
Funnel..... 305

G

Gas torch..... 255
Grinding / Cutting / Machining..... 106, 228–230, 234, 247, 261, 315
Grip pliers..... 105, 211
Guiding rail..... 70

H

Hammer..... 95, 106, 109, 117–118,
..... 127, 220, 328, 378
Hand riveting tool..... 212, 214
Hexagon socket profile tool..... 101, 141, 144,
..... 149–152, 158, 161, 164–165, 217
Hinged-door cabinet..... 86–87
Holder for paper reel..... 62
Hose clamp pliers..... 212, 271
HSS drill..... 234
Hydraulic cylinder..... 344–347, 375, 400, 402
Hydraulic pump and accessories..... 349–350, 353
Hydraulic service jack..... 322–323

I

Impact wrenches and sockets	100, 160, 170–171, 173, 176, 244–245, 319, 321
Induction heater and accessories	334–335
Injector sealing seat cleaning	272
Inner bearing ring puller	338
Inside wedge (Ribe CV) tool	101, 109, 158, 167
Inspection tool	258, 314

J

Jack stand and service jack	322–324
Jack-knife	229
Japan spatula	253

K

Kneeling mat	258
Knife / shears	228–229, 234

L

Lambda sensor tool	268
Lamp / light	258–259
Laptop table	61
Line wrench	316
Lock	69

M

Machinist's hammer	220
Magnetic pick-up tool	254
Manometer	350
Measuring / testing	218, 227, 238–241, 258, 263–265, 284–288, 290–291, 294, 309, 314–315, 327
Measuring / testing / Tape measure	227
Mechanic's creeper	97
Mechanical Spindle	351, 400
Mobile work bench	50–51, 59–60, 396–399
Motor vehicle chassis / steering tie rod / shock absorber	336–337, 362, 365, 393
Motor vehicle electrics / electronics	263–265
Motor vehicle wheel bearing tool	338, 354–365, 367–368, 371–373, 379–384, 400, 402–403, 408, 410, 413
Multi-purpose profile tool	134, 140, 159, 164
Multi-Tool	213, 252
Multiboxes	94–97, 367–375
Multifunctional drain pan	255
Multimeter / measuring cable	263–264

N

Nut / socket	94, 99–100, 104, 106, 108, 110–113, 115, 126, 133–143, 145–154, 156–160, 162–181, 201, 216–217, 319, 321
Nut-runners and inserts	100, 160, 170–171, 173, 176, 244–245, 319, 321

O

Offset screwdriver	115–116, 199
Oil service tools	255, 294–299, 305
Open-end wrench	102–103, 113–115, 128, 188–190, 192, 194

P

Panel partition	66
Perforated plate	90
Pick-up tool with claws	254
Plastic cover	70–71
Pliers	105–107, 116–118, 122–123, 127, 204–215, 219, 266, 271, 326, 352
Pneumatic tools	100, 244–249, 321
Pozidriv (PZ) tool	141, 147
Pressure spindle	351
Pry bar	226, 325
Pull-handle	63
Puller / extractor	269, 331, 338, 340, 362, 365, 385, 388, 401, 404, 409–412

R

Ratchet / ratcheting wrench	101–103, 115, 135–137, 145, 162, 174, 177–178, 188–190, 192–193, 217
Ratchet box	133–134, 142–143, 156, 159, 172, 178–181, 216, 321
Ratcheting combination wrench	102–103, 115, 117, 121, 189–190, 192
Ratcheting combination wrench with hinge	103, 192
Ratcheting open-end wrench	188
Refractometer	286
Release lever	225–226, 325
Reversible ratchet	135–137, 145, 162–163, 174, 177, 217
Ribe CV tool	101, 109, 158, 167
Rotary handle ratchet	137, 145, 162
Rotation angle tester	241
Round file	230
Round-nose pliers	219
Rubber hammer	328

S

Sabre saw	228
Safety platform	52
Safety spring vice	393–394
Scraper	104, 222, 225, 352
Screw extractor	159, 171
Screwdriver socket	94, 100–101, 112–113, 120–121, 140–141, 144, 147–152, 156–158, 161, 164–167, 217
Screwdrivers and bits	100–101, 103–104, 106, 109, 112–113, 115–117, 122, 127, 135, 139–141, 147–153, 156–158, 164–167, 169, 178, 195–203, 217–218, 238, 296
Seeger ring pliers	105, 206–210, 212, 271, 352
Separation sheet	66
Serration tool	101, 109, 157, 165–166, 175
Service jack	322–324
Service jacks and jack stands	322–324
Service trolley	52

S

Set / assortment.....	99-111, 113-118, 125-128, 133-134, 143, 156-159, 172-173, 176-181, 188, 192, 195-197, 199-201, 207, 211, 216, 218, 222-223, 226-227, 234, 253-255, 260, 264, 266, 268, 270-281, 284, 287-288, 291, 294, 298, 302, 304-305, 312-313, 316, 320-321, 324, 326, 331-333, 337, 347, 351, 355-360, 363-364, 372-374, 376, 378, 387-389, 391, 400-403, 405-407, 409-410, 412-415
Shears / knife	228-229, 234
Shock absorber tool.....	336-337, 339, 362, 365, 393
Silent block / bushings tool.....	374, 386-387, 389-392, 413
Sliding head	152
Sliding T-handle / sliding piece.....	137, 168, 174-175
Slot profile tool.....	141, 147, 195-196, 218
Snap ring pliers	105, 206-210, 212, 271, 352
Snipe nose pliers	204-205, 219
Socket.....	94, 99-100, 104, 106, 108, 110-113, 115, 126, 133-143, 145-160, 162-181, 201, 216-217, 319-320
Socket combinations.....	120, 132, 178-181
Socket wrench set.....	133-134, 142-143, 156, 159, 172, 178-181, 216, 321
Soft face hammer.....	220, 328
Soft foam insert.....	99-119, 123-128, 371, 400-403
Soldering iron.....	255
Solid steel ratchet.....	135-136, 145, 162
Spanner socket set.....	133-134, 142-143, 156, 159, 172, 178-181
Spark plug tools.....	146, 164, 205
Spatula	253
Specialty tool for	
brakes	234, 302-316, 352, 404-405, 412
axles	339
electricians.....	95, 106, 108, 216-219
wheels / tyres	119, 319-320, 325-328, 405
Spin type speeder.....	137
Spindle, mechanical.....	351, 400
Spring bolt tool	412, 414-415
Square drive	
6.3 mm (¼ inch).....	99, 110-112, 126, 133-141, 153, 180-181
10 mm (¾ inch).....	138, 142-143, 145-154, 168, 182-183
12.5 mm (½ inch).....	100, 110-112, 126, 138, 152-153, 156-160, 162-171, 173, 180-181, 217, 244, 246, 319, 321
20 mm (¾ inch)	172-174
25 mm (1 inch)	175
Steering wheel level.....	328
Storage shelf	71, 90
Supporting joint tool.....	337, 387-388, 405
Swivel castor	52, 67
Synthetic repair tool.....	333

T

T-handle screwdriver.....	116, 200, 238
Tamper-resistant TORX® tool	140, 147-149, 167
Telescopic inspection mirror	253
Testing / measuring	238-241, 258, 263-264, 290-291, 314
Tool cabinet	73
Tool case / box.....	94-97, 178, 182-183, 367, 371, 374-375
Tool chest	54
Tool hook.....	73
Tool organisation	37-51, 53-63, 66-74, 78-81, 83, 86-91, 99-113, 115-119, 125-127, 371, 396, 400-403
Tool trolley and accessories.....	37-49, 52-59, 61-63, 66-71, 74, 396
Tools for	
commercial vehicles.....	404-415
engines	268, 270-282, 286-288, 290
motor vehicles	263-265, 336-338, 354-365, 367-368, 371-373, 379-384, 393, 400, 402-403, 408, 410, 413

T

Torque tool.....	238-240
TORX® Tool.....	101, 104, 109, 140, 144, 146-149, 157, 161, 163, 166-167, 178, 197, 199-200
Tractive hydraulic cylinder.....	344-346
Tray.....	255
Tube cutter.....	234
Tube flaring tool.....	310-314, 316
Turbo system diagnostics.....	287-288
Twist drill bits	234
Tyre iron pry bar.....	325
Tyre lever.....	325
Tyre pressure control system (TPCS) tool.....	320

U

Under-bench drawer cabinet	82-85
Universal joint	137, 152, 168, 176
Universal pliers	213

V

V-ribbed belt tool.....	271
Vacuum and pressure pump.....	291, 297
VDE tools	95, 106-108, 216-219
Vernier calliper.....	227
Vice.....	74
VIGOR 1000.....	40-42, 50-51, 60
VIGOR 1000 XD.....	48-49, 58
VIGOR 1000 XL.....	43, 46-47, 56-57, 59
Voltmeter.....	218

W

Wall cabinet.....	88
Wall unit	69, 73, 78-91
Wheel bolt tool.....	405
Window pane holder.....	332
Wiper arm puller.....	331
Wire brush.....	231
Wire stripper	219
Wobble / flexible extension.....	137-138, 154, 169
Wooden worktop	71, 89
Work bench and accessories.....	50-51, 59-60, 72-73, 396
Work lamp / light	258-259
Work platform / ladder.....	52
Workshop equipment	69, 73, 78-81, 83, 86-91, 256-258, 260
Workshop torch / light	258-259
Worktop.....	70-71, 89
Wrench.....	102-103, 113-115, 186-193, 316
Wrenching bar.....	226, 325

X

XZN tools.....	101, 109, 144, 157, 161, 165-166, 175
----------------	---------------------------------------



Numerical Index

VIGOR No.	Page	VIGOR No.	Page	VIGOR No.	Page	VIGOR No.	Page	VIGOR No.	Page	VIGOR No.	Page
V1008	190	V1446	229	V1717	209	V1963-21	285	V2028	218	V2106	164
V1009	190	V1461N	184	V1718	209	V1963-22	285	V2029	218	V2107	164
V1010	190	V1461N-6X7	184	V1719	209	V1963-23	285	V2030	218	V2108	153
V1021	190	V1461N-8X9	184	V1722	263	V1963-24	285	V2059	165	V2109	168
V1022	190	V1461N-10X11	184	V1728	312	V1963-25	285	V2060	165	V2110	169
V1023	190	V1461N-12X13	184	V1740	254	V1963-3	285	V2061	218	V2111	173
V1025	190	V1461N-14X15	184	V1741	254	V1963-4	285	V2062	218	V2112	294
V1026	190	V1461N-16X17	184	V1764	254	V1963-5	285	V2063	218	V2113	165
V1027	190	V1461N-18X19	184	V1781	178	V1963-6	285	V2064	218	V2114N	153
V1028	190	V1461N-20X22	184	V1782	312-313, 316	V1963-7	285	V2065	165	V2115N	154
V1029	190	V1461N-21X23	184	V1783	221	V1963-8	285	V2066	165	V2116N	152
V1030	190	V1461N-22X24	184	V1785	213	V1963-9	285	V2067	165	V2117N	154
V1031	190	V1461N-24X27	184	V1787	230	V1963N	284	V2068	165	V2118N	152
V1135	220	V1461N-25X28	184	V1788	230	V1970	36, 55	V2069	164	V2119N	146
V1138	218	V1461N-30X32	184	V1789	230	V1976	140	V2070	164	V2120N	146
V1208	195	V1524N	186	V1790	230	V1977	140	V2071	153	V2121	165
V1209	195	V1524N-6X7	187	V1801	230	V1979	140	V2072	164	V2122	165
V1212	220	V1524N-8X9	187	V1802	211	V1980	140	V2073	164	V2123	165
V1213	222	V1524N-10X11	187	V1803	211	V1981	140	V2074	164	V2124	165
V1214	221	V1524N-12X13	187	V1804	211	V1982	140	V2075	164	V2126	165
V1215	221	V1524N-14X15	187	V1808	211	V1983	140	V2076	164	V2128	165
V1216	221	V1524N-16X17	187	V1893	255	V1984	140	V2077	164	V2129	165
V1217	221	V1524N-18X19	187	V1897	134	V1985	140	V2078	164	V2130N	140
V1218	221	V1524N-20X22	187	V1898	159	V1986	140	V2079	164	V2132	165
V1219	221	V1524N-21X23	187	V1901	36, 54	V1987	140	V2080	165	V2133	166
V1220	221	V1524N-24X27	187	V1902	36, 54	V1988	164	V2081	165	V2134	166
V1221	221	V1524N-25X28	187	V1903	70	V1989	164	V2082	165	V2135	166
V1222	221	V1524N-30X32	187	V1904	70	V1990	164	V2083	165	V2136	140
V1281	295	V1571	328	V1905	68	V1991	164	V2084	165	V2137	166
V1283	222	V1584	327	V1906	68	V1992	164	V2085	165	V2138	140
V1293	176	V1586	286	V1907	67	V1993	164	V2086	165	V2139	140
V1301	226	V1616	207	V1908	67	V1994	164	V2087	165	V2140	140
V1304	228	V1617	207	V1909	70	V1995	164	V2088	165	V2141	140
V1345	229	V1637	195	V1917	157	V1996	164	V2089	165	V2142	140
V1368	222	V1657	326	V1918	157	V1997	164	V2090	165	V2143	146
V1369	226	V1698	195	V1919	158	V1998	164	V2091	165	V2144	146
V1371	225	V1699	195	V1963-1	285	V1999	164	V2092	165	V2145	146
V1371-1	225	V1700	195	V1963-10	285	V2000	164	V2094	165	V2146	146
V1371-2	225	V1701	195	V1963-11	285	V2001	164	V2095	165	V2149	148
V1371-3	225	V1702	195	V1963-12	285	V2002	164	V2096	165	V2151	166
V1371-4	225	V1703	195	V1963-13	285	V2003	164	V2097	165	V2152	166
V1371-5	225	V1704	195	V1963-14	285	V2004	164	V2098	165	V2153	166
V1371-6	225	V1706N	179	V1963-15	285	V2014	138	V2099	165	V2154	166
V1372	222	V1707	234	V1963-16	285	V2016N	146	V2100	165	V2155	166
V1409	200	V1711N	308	V1963-17	285	V2017N	146	V2101	164	V2156	166
V1410	200	V1713	227	V1963-18	285	V2018N	146	V2102	164	V2157	166
V1423	327	V1714	227	V1963-19	285	V2019N	146	V2103	164	V2158	166
V1426N	213	V1715	228	V1963-20	285	V2020N	146	V2104	164	V2159	166
V1438	254	V1716	209			V2027	218	V2105	164	V2160	166

Numerical Index



VIGOR No.	Page	VIGOR No.	Page	VIGOR No.	Page	VIGOR No.	Page	VIGOR No.	Page	VIGOR No.	Page
V2161	166	V2217	167	V2287N	147	V2393-XD	63	V2442N	140	V2496	156
V2162	166	V2218	167	V2288N	147	V2394	234	V2443N	140	V2497	200
V2163	166	V2219	167	V2289N	147	V2395	234	V2444N	140	V2498	200
V2165	166	V2220	167	V2290N	147	V2396	234	V2445N	140	V2499	266
V2167	166	V2221	167	V2291N	147	V2397	62	V2446N	140	V2499-A	266
V2168	166	V2222	167	V2292N	147	V2398	66	V2447N	140	V2499-B	266
V2169	166	V2223	167	V2293N	147	V2399	66	V2448N	199	V2499-C	266
V2170	166	V2224	167	V2294N	147	V2400	183	V2449N	199	V2499-D	266
V2171	166	V2225	167	V2295N	148	V2401	171	V2450N	199	V2499-F	266
V2172	166	V2226	167	V2296N	148	V2402	171	V2451N	199	V2501	200
V2173	166	V2227	167	V2297N	148	V2403	171	V2452N	139	V2502	200
V2174	166	V2228	167	V2298N	148	V2404	159	V2453	320	V2503	200
V2175	166	V2229	167	V2299N	148	V2405	171	V2453N	137	V2504	200
V2176	166	V2230	167	V2300N	148	V2406	171	V2454N	137	V2505	200
V2177	166	V2231	167	V2301N	148	V2407	171	V2455N	138	V2506	200
V2178	166	V2232	167	V2302N	148	V2408	171	V2456N	138	V2507	200
V2179	166	V2233	167	V2303N	148	V2409	171	V2457N	137	V2508	222
V2180	166	V2234	328	V2305N	143	V2410	171	V2458N	137	V2509	222
V2181	166	V2235	328	V2311N	146	V2411	315	V2459	286	V2511N	295
V2182	166	V2249	315	V2312N	146	V2412	207	V2460N	156	V2512	326
V2183	166	V2250	315	V2313N	146	V2413N	139	V2461N	180	V2513	326
V2184	166	V2256N	173	V2314N	146	V2414N	133	V2462	69	V2514	326
V2185	140	V2257	321	V2315N	146	V2415N	139	V2463	73	V2515	326
V2186	140	V2261N	146	V2316	259	V2416N	139	V2464	183	V2516	326
V2187	140	V2262N	146	V2317N	174	V2417N	139	V2465N	163	V2517	73
V2188	140	V2263N	146	V2318N	172	V2418N	139	V2466	312	V2518	73
V2189	140	V2264N	146	V2319N	174	V2419N	139	V2467	312	V2519	73
V2193	147	V2265N	146	V2320N	174	V2420N	139	V2471	321	V2520	73
V2194	147	V2266N	146	V2321N	174	V2421N	139	V2472	321	V2521	295
V2195	147	V2267N	146	V2322N	174	V2422N	139	V2473	321	V2522	321
V2196	163	V2268N	146	V2323N	173	V2423N	139	V2474	321	V2523	331
V2197	163	V2269N	146	V2324N	173	V2424N	139	V2475	321	V2531	73
V2200	167	V2270N	146	V2325N	173	V2425N	139	V2477	324	V2532	73
V2201	158	V2271N	146	V2326N	173	V2426N	139	V2478	323	V2533N	140
V2202	167	V2272N	146	V2327N	173	V2427N	141	V2481	322	V2534N	140
V2203	167	V2273N	146	V2328N	173	V2428N	141	V2482	200	V2535N	140
V2204	167	V2274N	146	V2329N	173	V2429N	141	V2483	200	V2536N	140
V2205	167	V2275N	146	V2331N	173	V2430N	141	V2484	200	V2537N	140
V2206	167	V2276N	146	V2332N	173	V2431N	141	V2485	200	V2538N	140
V2207	167	V2277N	146	V2333N	173	V2432N	141	V2486	200	V2539N	140
V2208	167	V2278N	146	V2334N	173	V2433N	141	V2487	222	V2540	312
V2209	167	V2279N	151	V2335N	173	V2434N	141	V2488	222	V2542	183
V2210	167	V2280N	151	V2336N	173	V2435N	141	V2489	200	V2551	312
V2211	167	V2281N	151	V2337N	173	V2436N	141	V2490	200	V2552	312
V2212	167	V2282N	151	V2338	258	V2437N	141	V2491	225-226	V2553	312
V2213	167	V2283N	151	V2347	259	V2438N	141	V2492	225-226	V2554	312
V2214	167	V2284N	151	V2379N	37	V2439N	141	V2493	225-226	V2555	312
V2215	167	V2285N	151	V2393	63	V2440N	141	V2494	225-226	V2556	312
V2216	167	V2286N	147	V2393-S	63	V2441N	141	V2495	225-226	V2558	312



Numerical Index

VIGOR No.	Page	VIGOR No.	Page	VIGOR No.	Page	VIGOR No.	Page	VIGOR No.	Page	VIGOR No.	Page
V2559	312	V2629	219	V2788-3.2	214	V2854	345, 372-373, 375	V2905	386	V2981	374
V2561N	163	V2630	219	V2788-4.0	214	V2857	391	V2906	386	V2992	352
V2562N	163	V2631	322	V2788-4.8	214	V2858	405	V2907	386	V2993	352
V2563N	163	V2632	322	V2788-6.4	214	V2859	361	V2908	386	V2994	352
V2564N	163	V2639	322	V2789N	314	V2860	357, 359, 371	V2909	386	V2995	390
V2565N	163	V2640	322	V2790	228	V2861	361	V2910	348	V2996	390
V2566N	163	V2641	219	V2791	210	V2862	361, 379	V2913	388	V2997	390
V2567N	163	V2643	219	V2792	210	V2863	361	V2914	388	V2998	390
V2568N	163	V2645	294	V2793	210	V2864	357, 359, 371	V2915	388	V2999	388
V2569N	163	V2647N	169	V2794	210	V2867	352, 414-415	V2916	390	V3000	388
V2570N	163	V2648	324	V2795	241	V2869	344	V2917	392	V3001	388
V2571N	163	V2654	231	V2804	192	V2871	378	V2920	404, 414-415	V3002	388
V2572N	163	V2655	249	V2805	192	V2872	378	V2922	378	V3008	351
V2573N	168	V2662	220	V2806	192	V2873	344, 376, 414-415	V2923	388	V3009	344
V2574N	163	V2663	220	V2807	192	V2874	346, 414	V2927	352	V3010	344
V2575N	168	V2664	220	V2808	192	V2875	382	V2928	352	V3011	344
V2576N	169	V2665	220	V2809	192	V2877	380	V2936	413	V3012	344
V2577N	169	V2666	249	V2810	192	V2879	380	V2937	412, 414-415	V3013	380, 384
V2578N	164	V2667N	168	V2811	192	V2880	382	V2941	137	V3014	391
V2579N	163	V2683	336	V2812	192	V2881	379-383	V2942	413	V3015	391
V2580N	163	V2684	336	V2813	192	V2882	381-382	V2943	405	V3016	391
V2581N	163	V2685	332	V2814	192	V2883	379, 381, 383	V2945	374	V3017	391
V2582N	164	V2687	178	V2815	189	V2884	389	V2946	374	V3018	345-346
V2584N	163	V2699	320	V2817	192	V2885	386	V2947	374	V3019	390
V2585N	163	V2699N	140	V2818	192	V2886	389	V2948	374	V3020	390
V2586N	163	V2700	320	V2819	192	V2888	383	V2949	374	V3021	382, 390
V2587N	163	V2700N	140	V2820	190	V2889	381	V2950	374	V3022	390
V2588N	163	V2701N	140	V2821	189	V2890	380, 382, 384	V2951	405	V3023	390
V2589N	163	V2705	193	V2822	189	V2891	386	V2955	374	V3024	390
V2590N	163	V2712N	38	V2823	189	V2892	386	V2961	374	V3025	390
V2591N	163	V2722	140	V2824	189	V2893	386	V2962	374	V3026	390
V2592N	163	V2723	140	V2825	189	V2894	386	V2963	374	V3027	390
V2593N	141	V2724	146	V2826	189	V2895	386	V2964	374	V3028	390
V2594N	141	V2725	146	V2827	189	V2896	386	V2965	374	V3029	390
V2595N	140	V2726	146	V2828	189	V2897	386	V2966	374	V3030	390
V2596N	140	V2727	146	V2829	189	V2898	386	V2967	374	V3031	390
V2597N	141	V2728	146	V2830	189	V2899	386	V2968	374	V3033	359, 378
V2598N	163	V2729	146	V2831	189	V2900	386	V2969	374, 376	V3034	359, 378
V2599N	163	V2730	163	V2832	189	V2901	386	V2971	374	V3035	359, 378-379
V2600N	163	V2731	163	V2833	189	V2902	386	V2972	374	V3036	359, 378
V2603N	163	V2732	163	V2837	112	V2903	386	V2973	374	V3039	354, 380
V2604	72	V2733	163	V2838	112	V2904	386	V2974	374	V3040	354, 380
V2613N	146	V2734	163	V2845	354			V2975	374	V3044	392
V2614N	146	V2735	163	V2846	353, 373			V2976	374	V3045	388
V2615N	146	V2762	324	V2847	353, 372			V2977	374	V3046	388
V2616N	154	V2781	204	V2849	375, 377			V2978	374	V3047	388
V2626	234, 312	V2782	204	V2850	348			V2979	374	V3048	388
V2627	229	V2783	205	V2851	348			V2980	374	V3049	388
V2628	219	V2788	214	V2853	351						

Numerical Index



VIGOR No.	Page	VIGOR No.	Page	VIGOR No.	Page	VIGOR No.	Page	VIGOR No.	Page	VIGOR No.	Page
V3050	392			V3230	405	V3343	216	V3576	272	V3685	298
V3051	392	V3127	345, 347, 390, 413-414	V3231	409, 414	V3344	217	V3577	272	V3686	298
V3052	392	V3128	344-346	V3232	406, 409	V3366	197	V3578	272	V3687	298
V3053	370, 386-387	V3129	345, 388	V3233	413-414	V3367	197	V3579	272	V3688	298
V3055	386	V3130	345-346	V3234	413-414	V3368	197	V3580	272	V3689	298
V3056	370, 386-387	V3131	346	V3235	413-414	V3369	197	V3582	349	V3690	298
V3057	386	V3132	346-347, 376, 410	V3236	413-414	V3370	197	V3591	272	V3691	298
V3058	379	V3133	346-347, 376	V3237	413-414	V3371N	175	V3592	272	V3693	302
V3060	355-356, 382	V3134	345	V3238	413-414	V3373N	175	V3593	272	V3694	302
V3061	379, 382	V3135	347, 390, 392	V3239	405	V3374N	175	V3594	272	V3695	302
V3063	359, 379	V3136	347, 390, 392	V3241	405	V3375N	175	V3597	196	V3696	302
V3067	379	V3137	347, 391-392	V3242	405	V3376N	175	V3598	196	V3697	302
V3068	382	V3138	391	V3243	405	V3377N	175	V3599	196	V3698	302
V3069	382	V3139	390	V3244	405	V3378N	175	V3600	196	V3699	302
V3070	356	V3140	378	V3245	405	V3379N	175	V3601	196	V3703	316
V3071	356	V3141	353	V3246	405	V3380N	175	V3602	196	V3704	316
V3072	354, 379	V3142	386	V3256	390	V3381	271	V3604	272	V3705	316
V3087	380	V3143	377	V3259	412	V3391	197	V3607	193	V3706	316
V3088	379-380, 382-383	V3144	377	V3260	412	V3392	197	V3609	195	V3708	376
V3090	382	V3145	377	V3261	412	V3393	197	V3610	195	V3709	376
V3091	381	V3146	379-381, 383	V3262	412	V3403	387	V3612	350	V3729	285
V3092	346, 410	V3147	377	V3263	409, 411-412, 414-415	V3404	387	V3613	195	V3730	316
V3093	389	V3148	377	V3264	406, 409	V3405	387	V3614	353	V3731	358
V3094	389	V3149	379-381, 383	V3265	406, 409	V3423	391	V3615	325	V3732	358
V3095	389	V3199	345	V3266	406-407, 413	V3424	391	V3631	392	V3734N	133
V3105	381	V3205	351	V3267	406-407, 413	V3425	391	V3634	409	V3735	214
V3106	379, 381-383, 413	V3206	351	V3274	379	V3427N	201	V3635	190	V3735-3.2	214
V3107	379, 381-383, 413	V3207	347	V3275	347	V3431	410, 413	V3636	190	V3735-4.0	214
V3108	381	V3208	347	V3277N	181	V3432	379	V3641	392	V3735-4.8	214
V3109	381	V3209	347	V3280N	175	V3433	379, 383	V3642	392	V3735-6.4	214
V3110	379, 383	V3210	347	V3287	384	V3434	410	V3649	370, 387	V3735-M10	214
V3111	383	V3211	389	V3302	390	V3436	391	V3650	387	V3735-M5	214
V3112	383	V3212	389	V3309	234	V3437	410	V3651N	139	V3735-M6	214
V3113	383	V3213	389	V3330	217	V3438	410	V3652N	153	V3735-M8	214
V3114	382	V3214	389	V3331	217	V3439	410	V3653	245	V3738	211
V3115	379	V3215	389	V3332	217	V3440	410	V3661	337	V3738-S	211
V3120	353	V3216	346	V3333	217	V3441	240	V3671	333	V3739	211
V3123	345	V3217	344	V3334	217	V3451	234	V3672	333	V3740	376
V3124	344-345	V3219	347	V3335	217	V3541	220	V3673	333	V3741	159
V3125	345	V3220	347	V3336	217	V3550	298	V3674	333	V3742	171
V3126	345, 347, 351, 378, 413-414	V3222	409, 414-415	V3337	217	V3551	333	V3675	333	V3743	171
		V3224	413	V3338	217	V3562	196	V3676	333	V3744	171
		V3225	413	V3339	217	V3563	325	V3677	333	V3745	171
		V3226	413	V3340	217	V3564	325	V3678	404	V3746	171
		V3227	405	V3341	217	V3571	271	V3680	360, 371	V3747	171
		V3228	302	V3342	217	V3572	272	V3681	298	V3750	411
		V3229	405			V3573	272	V3682	298	V3751	376
						V3574	272	V3683	298	V3753	358-359, 368-369
						V3575	272	V3684	298		



Numerical Index

VIGOR No.	Page	VIGOR No.	Page	VIGOR No.	Page	VIGOR No.	Page	VIGOR No.	Page	VIGOR No.	Page
V3755	357	V3761	410	V4202	285	V4309	319	V4416-2	310-311, 313	V4451-7	265
V3758	358-359, 368-369	V3762	410	V4217	134	V4310N	226	V4416-3	310-311, 313	V4451-8	265
V3760-0	306	V3763	411	V4218	347	V4311	138	V4416-4	310-311, 313	V4451-9	265
V3760-0-DISC	306	V3764	411	V4219	39	V4312	138	V4416-5	310	V4461	290
V3760-1	306	V3765	411	V4220	349	V4313	138	V4418	197	V4472N	185
V3760-11	307	V3863	337	V4221	201	V4314	154	V4419	197	V4473N	185
V3760-12	307	V3865	359-360	V4222	201	V4315	154	V4420	197	V4473N-10	186
V3760-2	306	V3866	360	V4223	201	V4316	154	V4421	197	V4473N-11	186
V3760-3	306	V3867	410	V4224	201	V4317	169	V4422	197	V4473N-12	186
V3760-4	306	V3868	376	V4225	201	V4318	169	V4423	280	V4473N-13	186
V3760-5	306	V3869	349	V4227	252	V4319	169	V4424	278	V4473N-14	186
V3760-6	306	V3870	349	V4228	252	V4324	263	V4425	182	V4473N-15	186
V3760-7	306	V3871	354, 357-358, 363	V4229	346, 415	V4324-1	263	V4427	208	V4473N-16	186
V3760-8	306	V3873	354, 357-358, 363-364	V4230	116	V4324-2	263	V4428	208	V4473N-17	186
V3760-9	307	V3874	354, 357-358, 363-364	V4231	116	V4325	291	V4429	208	V4473N-18	186
V3760-A	307	V3898	239	V4233	287	V4326	264	V4430	208	V4473N-19	186
V3760-A1	307	V3899	240	V4234	220	V4326/2	264	V4431	320	V4473N-20	186
V3760-B	307	V4111	69	V4235	220	V4342	347	V4431-1	238, 320	V4473N-21	186
V3760-B1	307	V4112	69	V4236	220	V4346	277	V4431-2	238, 320	V4473N-22	186
V3760-B2	307	V4113	298	V4241	252	V4347	281	V4431-3	320	V4473N-24	186
V3760-C	307	V4114	298	V4242	346	V4348	281	V4431-4	320	V4473N-27	186
V3760-D	307	V4115	298	V4243	347	V4352	393, 395	V4431-5	320	V4473N-30	186
V3760-E	307	V4122	71	V4244	347	V4353	393, 395	V4431-6	320	V4473N-32	186
V3760-F	307	V4126	337	V4245	347	V4354	393, 395	V4441	207	V4473N-36	186
V3760-F1	307	V4130	110	V4246	347	V4369	297	V4442	207	V4473N-6	186
V3760-F2	307	V4153	331	V4248	337	V4371	279	V4451	265	V4473N-7	186
V3760-G	307	V4154	331	V4249	337	V4372	277	V4451-1	265	V4473N-8	186
V3760-G1	307	V4155	331	V4250	337	V4373	278	V4451-10	265	V4473N-9	186
V3760-H6	307	V4156	331	V4251	346	V4374	279	V4451-11	265	V4476-1	393
V3760-H7	307	V4157	331	V4252	346	V4375	280	V4451-12	265	V4476N	394
V3760-IV	307	V4158	331	V4253	346	V4381	303	V4451-13	265	V4477	171
V3760-J	307	V4159	331	V4254	346	V4381-1	303	V4451-14	265	V4478	171
V3760-K	307	V4160	331	V4255	353	V4381-2	303	V4451-15	265	V4481	36, 56
V3760-K1	307	V4161	331	V4257	285	V4381-3	303	V4451-16	265	V4481-1	66
V3760-K2	307	V4162	331	V4258	285	V4381-4	303	V4451-17	265	V4481-X	36, 57
V3760-M	307	V4163	331	V4274	229	V4383	298	V4451-18	265	V4481-X/375	46
V3760-N	307	V4164	331	V4275	229	V4384	298	V4451-19	265	V4481-X/499	47
V3760-P	307	V4165	331	V4278	253	V4385	298	V4451-20	265	V4481-XD	36, 58
V3760-P1	307	V4166	331	V4279	253	V4398N	169	V4451-21	265	V4481-XD/469	48
V3760-Q	307	V4188	110	V4282	276	V4399	309	V4451-22	265	V4481-XD/775	49
V3760-R	307	V4192	287	V4282-19	281	V4400	333	V4451-23	265	V4484	296
V3760-R1	307	V4193	332	V4283	274	V4411	304	V4451-24	265	V4491	363
V3760-S	307	V4199	201	V4284	275	V4413	296	V4451-25	265	V4493	363
V3760-T	307	V4200	201	V4285	273	V4414	296	V4451-26	265	V4497	43
V3760-Z	307	V4201	297	V4303	199	V4415	296	V4451-27	265	V4499	410
V3760N	306	V4201-1	297	V4304	288	V4416	310	V4451-28	265	V4500	410
				V4305	288	V4416-1	310-311, 313	V4451-29	265	V4501	116
				V4306	288			V4451-30	265	V4510	119
				V4308	229			V4451-31	265	V4511	119

Numerical Index



VIGOR No.	Page	VIGOR No.	Page	VIGOR No.	Page	VIGOR No.	Page	VIGOR No.	Page	VIGOR No.	Page
V4514	111	V4598-21	355	V4646N-12	260	V4700-L	96, 369	V4915	401	V4975	100
V4521	126	V4598-22	355	V4646N-13	260	V4700-R	97	V4915-L	401	V4975-L	100
V4542	44	V4598-3	355-356, 368	V4646N-14	260	V4700-XL	96, 370	V4917	401	V4977	100
V4545	407, 409	V4598-30	355-356, 368	V4646N-15	260	V4700-XXL	97	V4917-L	401	V4977-L	100
V4546	407, 409	V4598-4	355, 368-369	V4646N-16	260	V4708	199	V4919	401	V4987	103
V4547	407, 409	V4599	356	V4646N-17	260	V4709N	163	V4919-L	401	V4987-L	103
V4548	407, 409	V4601	412	V4646N-18	260	V4726	112	V4921	401	V4989	103
V4549	407, 409	V4602	412	V4646N-19	260	V4727	112	V4921-L	401	V4989-L	103
V4550	406-407	V4602-1	412	V4646N-8	260	V4728	113	V4923	403	V4991	104
V4551	345	V4603	414	V4646N-9	260	V4729	113	V4923-L	403	V4991-L	104
V4552	345	V4604	415	V4646S-10	260	V4752	112	V4930	309	V4995	105
V4553	345	V4605	408	V4646S-11	260	V4753	112	V4941	272	V4995-L	105
V4554	409	V4606	408	V4646S-12	260	V4754	119	V4942	199	V4997	104
V4555	409	V4607	408	V4646S-13	260	V4755	119	V4944	136	V4997-L	104
V4556	409, 411-412	V4608	408	V4646S-14	260	V4758	52	V4944-REP	136	V4999	105
V4560	41	V4609	408, 412	V4646S-15	260	V4800	244	V4944-S	136	V4999-L	105
V4561	42	V4610	408	V4646S-16	260	V4813	36, 60	V4944-XS	136	V5004	105
V4562	406-407	V4614	355	V4646S-17	260	V4813-1	71	V4945	145	V5004-L	105
V4563	406-407	V4629	354, 367	V4646S-18	260	V4813-2	71	V4945-REP	145	V5006	106
V4564	406-407	V4629-1	354, 368	V4646S-19	260	V4814	36, 59	V4945-S	145	V5006-L	106
V4565	406, 414	V4631	125	V4646S-8	260	V4814-1	69	V4946	162	V5009	125
V4566	407, 415	V4632	125	V4646S-9	260	V4814-2	67	V4946-REP	162	V5011	106
V4568	345	V4633	125	V4647	174	V4814-3	67	V4946-S	162	V5011-L	106
V4569	408	V4634	406-407	V4648	305	V4814-4	71	V4950-S	177	V5013	106
V4570	408	V4635	413	V4651	229	V4884	162	V4951	188	V5013-L	106
V4571	408	V4636	338	V4655	195	V4885	226	V4951-10	188	V5015	107
V4572	408	V4637	212	V4661	220	V4891	334	V4951-11	188	V5015-L	107
V4573	408	V4637-1	212	V4661-1	220	V4891-1	334	V4951-12	188	V5017	104
V4574	408	V4638	52	V4663	222	V4891-10	335	V4951-13	188	V5017-L	104
V4575	408	V4642	340	V4664	198	V4891-2	334	V4951-14	188	V5018	125
V4577	410	V4644	305	V4665	198	V4891-3	334	V4951-15	188	V5019	202
V4586	126	V4644-1	305	V4666	198	V4891-4	334	V4951-16	188	V5020	203
V4587	111	V4646	260	V4667	196	V4891-5	335	V4951-17	188	V5024	173
V4588	116	V4646M-10	260	V4668	304	V4891-6	335	V4951-18	188	V5025	173
V4594	356	V4646M-11	260	V4676	371, 402	V4891-7	335	V4951-19	188	V5026	173
V4594-1	356	V4646M-12	260	V4678	371, 402	V4891-8	335	V4951-21	188	V5027	362, 369
V4596	347	V4646M-13	260	V4680	371-373	V4891-9	335	V4951-22	188	V5042	196
V4597	347	V4646M-14	260	V4690	227	V4891/6	335	V4951-8	188	V5043	196
V4598	355, 367	V4646M-15	260	V4697	311	V4893	63	V4961	190	V5044	196
V4598-10	355	V4646M-16	260	V4697-1	311	V4904	375, 402	V4962	190	V5045	222
V4598-11	355	V4646M-17	260	V4697-2	311, 313	V4904-L	375, 402	V4963	190	V5047	270
V4598-12	355-356	V4646M-18	260	V4699	351	V4906	367, 402	V4964	190	V5048	294
V4598-13	355	V4646M-19	260	V4699-1	351	V4906-L	367, 402	V4965	190	V5055	40
V4598-14	355	V4646M-8	260	V4699-2	351	V4908	400	V4966	190	V5058	400
V4598-15	355	V4646M-9	260	V4699-3	351	V4908-L	400	V4969	259	V5058-L	400
V4598-16	355	V4646N-10	260	V4699-4	351	V4910	403	V4971	99	V5060	400
V4598-2	355, 368	V4646N-11	260	V4699-5	351	V4910-L	403	V4971-L	99	V5060-L	400
V4598-20	355			V4699-6	351	V4913	403	V4973	99	V5062	401
				V4699-7	351	V4913-L	403	V4973-L	99	V5062-L	401



Numerical Index

VIGOR No.	Page	VIGOR No.	Page	VIGOR No.	Page	VIGOR No.	Page	VIGOR No.	Page	VIGOR No.	Page
V5064	400	V5173	115	V5513-1	313	V5635	118	V6000-013	89	V6008	145
V5066	403	V5173-L	115	V5513-2	313	V5635-L	118	V6000-013-X	89	V6012	162
V5066-L	374, 403	V5175	116	V5513-3	313	V5636	117	V6000-015	90	V6012-REP	162-163
V5068	103	V5175-L	116	V5517	188	V5636-L	117	V6000-017	87, 90	V6014	135
V5068-L	103	V5180	52	V5531	332	V5637	118	V6000-017XL	88, 90	V6014-REP	135
V5070	104	V5182	173	V5540	259	V5637-L	118	V6000-018	86, 90	V6017	144
V5070-L	104	V5183	173	V5548	368	V5638	127	V6000-018XL	86, 90	V6018	144
V5072	106	V5191	52	V5548-L	368	V5638-L	127	V6000-019	84	V6019	144
V5072-L	106	V5202	132	V5549	368	V5649	314	V6000-019XL	84	V6027	295
V5075	102	V5202-1	132	V5549-1	369	V5650	204	V6000-01XL	84	V6028	322
V5075-L	102	V5202-10	132	V5550L	160	V5660	286	V6000-02	86	V6029	323
V5077	103	V5202-11	132	V5550L-10	170	V5661	198	V6000-020	69	V6030	225
V5077-L	103	V5202-12	132	V5550L-11	170	V5671	244	V6000-021	89	V6030-12	225
V5081	109	V5202-13	132	V5550L-12	170	V5672	247	V6000-021-X	89	V6030-16	225
V5081-L	109	V5202-14	132	V5550L-13	170	V5673	247	V6000-022	89	V6030-20	225
V5085	109	V5202-2	132	V5550L-14	170	V5674	246	V6000-022-X	89	V6038	145
V5085-L	109	V5202-4	132	V5550L-15	170	V5675	246	V6000-023	89	V6038-REP	145
V5087	108	V5202-4.5	132	V5550L-16	170	V5676	268	V6000-023-X	89	V6039	177
V5087-L	108	V5202-5	132	V5550L-17	170	V5677	256	V6000-024	89	V6048	194
V5091	101	V5202-5.5	132	V5550L-18	170	V5681	213	V6000-024-X	89	V6049	194
V5091-L	101	V5202-6	132	V5550L-19	170	V5691	315	V6000-025	89	V6068	203
V5093	101	V5202-7	132	V5550L-21	170	V5740	402	V6000-025-X	89	V6074	148
V5093-L	101	V5202-8	132	V5550L-22	170	V5740-L	402	V6000-026	89	V6075	148
V5095	101	V5202-9	132	V5550L-24	170	V5741N	370	V6000-026-X	89	V6076	148
V5095-L	101	V5434	45	V5550S	160	V5902	370, 389	V6000-027	89	V6077	148
V5097	101	V5436	135	V5550S-10	170	V5903	362, 369	V6000-027-X	89	V6078	148
V5097-L	101	V5437	162	V5550S-11	170	V5903-1	362	V6000-02XL	86	V6079	148
V5099	100	V5480	253	V5550S-12	170	V5903-2	362	V6000-03	87	V6080	148
V5099-L	100	V5484	282	V5550S-13	170	V5903-3	362	V6000-030	82	V6081	148
V5103	108	V5485N	198	V5550S-14	170	V5904	366	V6000-030XL	82	V6082	148
V5103-L	108	V5488	255	V5550S-15	170	V5904-1	366	V6000-031	83	V6083	148
V5109	113	V5489	36, 53	V5550S-16	170	V5904-2	364, 366	V6000-031XL	83	V6084	148
V5109-L	113	V5489-1	70	V5550S-17	170	V5904-3	366	V6000-032	85	V6085	148
V5111	117	V5489-2	71	V5550S-18	170	V5904-4	366	V6000-032XL	85	V6086	148
V5111-L	117	V5489-3	68	V5550S-19	170	V5905	365	V6000-033	85	V6087	148
V5115	111	V5489-4	68	V5550S-21	170	V5906	364	V6000-033XL	86	V6088	148
V5115-L	111	V5493	205	V5550S-22	170	V5906-1	364	V6000-03XL	88	V6089	148
V5128	367	V5494	205	V5550S-24	170	V5909	314	V6000-04	88	V6090	148
V5156	50	V5496	206	V5554	372	V5916	385	V6000-040/4	91	V6091	148
V5158	51	V5496-1	206	V5554-2	373	V5916-XL	385	V6000-041/4	91	V6092	148
V5160	396	V5497	206	V5591	227	V5922	286	V6000-04XL	88	V6093	148
V5162	94	V5502	202	V5601	199	V5925	258	V6000-05	90	V6094	149
V5164	94	V5505	176	V5602	100	V5930	319	V6000-06	90	V6095	149
V5165	95	V5505-1/2	176	V5602-L	100	V5931	319	V6000-07	91	V6096	149
V5167	95	V5505-1/4	176	V5630	213	V6000-01	83	V6000-08	89	V6097	149
V5168	375	V5505-3/8	176	V5633	105	V6000-010	91	V6000-08-X	89	V6098	149
V5169	374	V5511	178	V5633-L	105	V6000-011	87	V6000-09	91	V6099	149
V5170	127	V5512	255	V5634	117	V6000-012	89	V6000-3	78	V6100	149
V5170-L	127-128	V5513	313	V5634-L	117	V6000-012-X	89	V6000-7	80	V6101	149

Numerical Index



VIGOR No.	Page	VIGOR No.	Page	VIGOR No.	Page	VIGOR No.	Page	VIGOR No.	Page	VIGOR No.	Page
V6102	149	V6151	152	V6230-5	224	V6726	114	V6813	122	V7018-M8	161
V6103	149	V6152	152	V6230-7	224	V6726-L	114	V6813-L	122	V7019	161
V6104	149	V6153	152	V6299	260	V6741	269	V6814	122	V7019-H10	161
V6105	149	V6154	152	V6300-13	299	V6742	256	V6814-L	122	V7019-H12	161
V6106	149	V6155	152	V6300-5	299	V6752-10	191	V6815	122	V7019-H14	161
V6107	149	V6156	152	V6300-8	299	V6752-11	191	V6815-L	122	V7019-H17	161
V6108	149	V6157	152	V6393	62	V6752-12	191	V6816	123	V7019-H19	161
V6109	149	V6158	152	V6393-S	62	V6752-13	191	V6816-L	123	V7019-H5	161
V6110	149	V6159	152	V6395	61	V6752-14	191	V6817	123	V7019-H6	161
V6111	149	V6160	152	V6396	61	V6752-15	191	V6817-L	123	V7019-H8	161
V6112	149	V6161	152	V6397	62	V6752-16	191	V6818	123	V7026	397
V6113	149	V6194	152	V6435	257	V6752-17	191	V6818-L	123	V7026-1	398
V6114	150	V6200	223	V6452	339	V6752-18	191	V6820	115	V7026-2	399
V6115	150	V6200-2	223	V6468	256	V6752-19	191	V6820-L	115	V7039	321
V6116	150	V6200-3	223	V6554	246	V6752-8	191	V6821	120	V7039-17	321
V6117	150	V6200-4	223	V6591	350	V6752-9	191	V6821-L	120	V7039-19	321
V6118	150	V6200-5	223	V6592	350	V6752/12	191	V6822	120	V7039-21	321
V6119	150	V6200-6	223	V6605	257	V6799	215	V6822-L	120	V7050	363
V6120	150	V6200-7	223	V6606	257	V6800-50	232	V6824	357	V7061	361
V6121	150	V6200-8	223	V6612	163	V6800-75	232	V6899	245	V7202	155
V6122	150	V6202	142	V6614	135	V6801-65	233	V6903	248	V7202-1	155
V6123	150	V6202-1	142	V6614-REP	135	V6802	232	V6904	248	V7202-10	155
V6124	150	V6202-10	142	V6632	307	V6803-100	232	V6905	249	V7202-11	155
V6125	150	V6202-11	142	V6633	307	V6803-75	232	V6906	247	V7202-12	155
V6126	150	V6202-12	142	V6634	307	V6804	233	V6906-10	247	V7202-13	155
V6127	150	V6202-13	142	V6635	307	V6805	233	V6917	234	V7202-14	155
V6128	150	V6202-14	142	V6638	145	V6806	233	V6917-REP	234	V7202-15	155
V6129	150	V6202-15	142	V6643	114	V6807	121	V6952	226	V7202-16	155
V6130	150	V6202-16	142	V6643-L	114	V6807-4	231	V6956	339	V7202-17	155
V6131	150	V6202-17	142	V6649	113	V6807-L	121	V6973	258	V7202-18	155
V6132	151	V6202-19	142	V6649-L	113	V6808	121	V6973-1	258	V7202-19	155
V6133	151	V6202-2	142	V6650	128	V6808-L	121	V7010-125K80	261	V7202-2	155
V6134	151	V6202-21	142	V6685-1/20	66	V6809	120	V7017	161	V7202-20	155
V6135	151	V6202-22	142	V6685-2/20	66	V6809-4	231	V7017-T30	161	V7202-21	155
V6136	151	V6202-3	142	V6685-3/10	66	V6809-L	120	V7017-T40	161	V7202-22	155
V6137	151	V6202-4	142	V6685-4/10	66	V6810	121	V7017-T45	161	V7202-24	155
V6138	151	V6202-5	142	V6686/5	65	V6810-115K40	261	V7017-T50	161	V7202-27	155
V6139	151	V6202-8	142	V6687/5	65	V6810-115K60	261	V7017-T55	161	V7202-3	155
V6140	151	V6202-9	142	V6688	64	V6810-115K80	261	V7017-T60	161	V7202-30	155
V6141	151	V6210-10	224	V6688-XD	65	V6810-125K40	261	V7017-T70	161	V7202-32	155
V6142	151	V6210-4	224	V6688-XL	65	V6810-125K60	261	V7017-T80	161	V7202-4	155
V6143	151	V6220-10	223	V6721	102	V6810-L	121	V7018	161	V7202-5	155
V6144	151	V6220-16	223	V6721-L	102	V6811	124	V7018-M10	161	V7202-8	155
V6145	151	V6220-20	223	V6722	102	V6811-115	261	V7018-M12	161	V7202-9	155
V6146	151	V6220-29	223	V6722-L	102	V6811-125	261	V7018-M14	161		
V6147	151	V6220/4	223	V6723	102	V6811-76	261	V7018-M16	161		
V6148	151	V6221	61	V6723-L	102	V6811-L	124	V7018-M18	161		
V6149	152	V6222	99	V6725	115	V6812	124	V7018-M5	161		
V6150	74	V6222-L	99	V6725-L	115	V6812-L	124	V7018-M6	161		

Wallmek No.	VIGOR No.	Designation	Page
01-00001	V5066	Pressure sleeve set	403
01-00001-002	V2946	Thrust rod, adjustable, 90 mm for V2868	374
01-00001-101	V2947	Pressure sleeve A Ø 40.7 mm for V2868	374
01-00001-102	V2948	Pressure sleeve A Ø 43.7 mm for V2868	374
01-00001-103	V2949	Pressure sleeve A Ø 46.7 mm for V2868	374
01-00001-104	V2950	Pressure sleeve A Ø 49.7 mm for V2868	374
01-00001-105	V2961	Pressure sleeve A Ø 52.7 mm for V2868	374
01-00001-106	V2962	Pressure sleeve A Ø 55.7 mm for V2868	374
01-00001-107	V2963	Pressure sleeve A Ø 58.7 mm for V2868	374
01-00001-108	V2964	Pressure sleeve A Ø 61.7 mm for V2868	374
01-00001-109	V2965	Pressure sleeve A Ø 65.7 mm for V2868	374
01-00001-110	V2966	Pressure sleeve A Ø 69.7 mm for V2868	374
01-00001-201	V2967	Pressure pipe A Ø 38.7 mm for V2868	374
01-00001-202	V2968	Pressure pipe A Ø 41.7 mm for V2868	374
01-00001-203	V2969	Pressure pipe A Ø 44.7 mm for V2868	374, 376
01-00001-204	V2971	Pressure pipe A Ø 47.7 mm for V2868	374
01-00001-205	V2972	Pressure pipe A Ø 50.7 mm for V2868	374
01-00001-206	V2973	Pressure pipe A Ø 53.7 mm for V2868	374
01-00001-207	V2974	Pressure pipe A Ø 56.7 mm for V2868	374
01-00001-208	V2975	Pressure pipe A Ø 59.7 mm for V2868	374
01-00001-209	V2976	Pressure pipe A Ø 62.7 mm for V2868	374
01-00001-210	V2977	Pressure pipe A Ø 65.7 mm for V2868	374
01-00001-211	V2978	Pressure pipe A Ø 68.7 mm for V2868	374
01-00001-212	V2979	Pressure pipe A Ø 71.7 mm for V2868	374
01-00001-213	V2980	Pressure pipe A Ø 75.7 mm for V2868	374
01-00001-214	V2981	Pressure pipe A Ø 79.7 mm for V2868	374
01-00004	V2867	Circlip tool	352, 414-415
01-00004-013	V2992	Spare pins for V2867	352
01-00004-014	V2993	Spare pins for V2867	352
01-00004-015	V2994	Spare pins for V2867	352
01-00009	V2916	Silent block bushing set, rear BMW	390
01-00009-001	V2995	Assembly ring	390
01-00009-002	V2996	Retaining ring	390
01-00009-003	V2997	Washer with thread	390
01-00010-001	V3028	Washer with thread	390
01-00010-002	V2998	Thrust washer	390
01-00010-003	V3029	Retaining ring	390
01-00010-004	V3030	Mounting ring	390
01-00011-001	V3031	Washer with thread	390
01-00018	V2860	Compact wheel bearing removal tool set, universal	357, 359, 371
01-00018-003	V3873	Fixing screw M14	354, 357-358, 363-364
01-00018-004	V3874	Screw M12	354, 357-358, 363-364
01-00018-020	V3755	Pressure foot set (removal) for compact wheel bearings	357
01-00020	V2853	Spindle set, mechanical	351

Wallmek No.	VIGOR No.	Designation	Page
01-00020-001	V3008	Drawbar	351
01-00020-002	V3206	Washer	351
01-00020-003	V3205	Thrust washer	351
01-00022-003	V3403	Pressure pipe	387
01-00022-004	V3404	Pressure plate	387
01-00022-005	V3405	Adapter ring	387
01-00022-010	V3649	Bushing set longitudinal strut, FORD · Volvo	370, 387
01-00022-020	V3650	Press frame	387
01-00023	V3436	Tool set for double silent blocks VAG	391
01-00023-001	V3423	Mounting pipe	391
01-00023-002	V3424	Thrust washer	391
01-00023-003	V3425	Pressure pipe	391
01-00024	V3751	Installation tool set for BMW drive shafts (hydraulic)	376
01-00024-001	V3709	Adapter M 24 x 1.5 mm	376
01-00024-002	V3708	Adapter M 27 x 1.5 mm	376
01-00024-005	V3868	Thrust washer	376
01-00024-010	V3740	Installation tool set for BMW drive shafts (mechanical)	376
01-00025	V3631	Transverse control arm bushing set, front VW T5	392
01-00025-001	V3641	Pressure plate	392
01-00025-002	V3642	Pressure sleeve	392
01-00026	V3731	Wheel bearing unit, screwed, removal tool set, universal	358
01-00026-020	V3758	Pressure foot set (removal) for screwed wheel bearing units	358-359, 368-369
01-00027	V3732	Wheel bearing unit, screwed, removal tool set, universal	358
01-00027-020	V3753	Pressure foot set (removal) for screwed wheel bearing units	358-359, 368-369
01-00028	V3865	Wheel bearing unit / compact wheel bearing, screwed, removal tool set, universal	359-360
01-00030	V4551	Tractive and compressive hydraulic cylinder 18 tonnes	345
01-00030-001	V4552	Hydraulic cylinder	345
01-00030-005	V4553	Pressure shaft M 24 x 3 mm	345
01-00031	V4342	Striker nut	347
01-00033	V4491	Compact wheel bearing assembly tool set, universal	363
01-00033-020	V4493	Pressure foot (pair) for compact wheel bearing assembly tool set, universal	363
01-00033-110	V3680	Compact wheel bearing removal / assembly tool set, universal	360, 371
01-00033-125	V3866	Wheel bearing unit and compact wheel bearing, screwed, removal / assembly tool set, universal	360

Wallmek No.	VIGOR No.	Designation	Page
01-00035	V4598	Wheel bearing / hub tool and drive shaft set, universal	355, 367
01-00035-001	V4614	Support disc, tapered, Ø 33.8 mm, for V4598	355
01-00035-002	V4598-2	Support disc, tapered, Ø 38.8 mm, for V4598	355, 368
01-00035-003	V4598-3	Support disc, tapered, Ø 43.8 mm, for V4598 · V4599	355–356, 368
01-00035-004	V4598-4	Support disc, tapered, Ø 59.8 mm, for V4598	355, 368–369
01-00035-010	V4598-10	Bearing washer Ø 61.8–62.8 mm	355
01-00035-011	V4598-11	Bearing washer Ø 63.8–64.8 mm for V4598	355
01-00035-012	V4598-12	Bearing washer Ø 65.8–66.8 mm for V4598 · V4599	355–356
01-00035-013	V4598-13	Bearing washer Ø 68.8–70.8 mm for V4598	355
01-00035-014	V4598-14	Bearing washer Ø 72.5–74.5 mm for V4598	355
01-00035-015	V4598-15	Bearing washer Ø 76.5–78.5 mm for V4598	355
01-00035-016	V4598-16	Bearing washer Ø 80.8–82.8 mm for V4598	355
01-00035-020	V4598-20	Bearing shell Ø 93 mm for V4598	355
01-00035-021	V4598-21	Bearing shell Ø 75.5 mm for V4598	355
01-00035-022	V4598-22	Bearing shell Ø 93 mm for V4598	355
01-00035-030	V4598-30	Pressure pipe length 78 mm for V4598 · V4599	355–356, 368
01-00036	V4594	Adjustable wheel bearing fixation	356
01-00036-020	V4594-1	Pressure foot set for V4594	356
01-00037	V4629	Wheel hub removal tool, universal	354, 367
01-00037-020	V4629-1	Pressure foot set for V4629	354, 368
01-00038	V4599	Wheel bearing tool set AUDI Q7, VW Touareg, PORSCHE Cayenne	356
01-00039	V4699	Pressure spindle set, manual	351
01-00039-001	V4699-1	Pressure spindle 190 mm	351
01-00039-002	V4699-2	Adapter	351
01-00039-010	V4699-4	Press axle 50 x Ø 19 mm	351
01-00039-011	V4699-5	Press axle 85 x Ø 19 mm	351
01-00039-020	V4699-6	Press axle 56 x Ø 24 mm	351
01-00039-021	V4699-7	Press axle 100 x Ø 24 mm	351
01-00039-040	V4699-3	Washer Ø 18.8 x 3 mm (4 pcs)	351
01-00040	V5027	Wheel hub puller	362, 369
01-00041-002	V3871	Crossbar	354, 357–358, 363
01-00041-002	V5904-2	Fixing plate 1.1/2" thread	364, 366
01-00041-003	V5904-3	Bolt	366
01-00041-005	V5904-4	Bolt M 14x 45	366
01-00042	V5903	Wheel bearing puller	362, 369

Wallmek No.	VIGOR No.	Designation	Page
01-00042-001	V5903-1	Bearing plate	362
01-00042-002	V5903-2	Washer	362, 365
01-00042-003	V5903-3	Drawbar M22, 121 mm	362, 365
01-00042-010	V7061	Screw set SUBARU rear wheel bearings	361
01-00044	V5904	Device for the removal of drive shafts, 6- and 8-holes	366
01-00044-001	V5904-1	Pressure foot set	366
01-00045	V5905	Wheel hub/wheel bearing puller for 6 and 8 bolts	365
01-00045-001	V5905-1	Hub plate 6 and 8 hole	–
01-00046	V5906	Wheel bearing unit, screwed, removal tool set, universal	364
01-00046-001	V5906-1	Pressure foot set	364
01-00047-020	V7050	Removal tool for screwed 4-hole wheel hubs/wheel bearings with special brake guard	363
02-00006	V3274	Wheel bearing tool set, rear MERCEDES-BENZ Vito and Viano	379
02-00008	V2878	Wheel bearing tool set, rear for FORD Transit	380
02-00009	V2923	Supporting joint tool set FORD	388
02-00009-001	V2999	Pressure sleeve	388
02-00009-002	V3000	Mounting / dismantling cap	388
02-00009-003	V3001	Mounting bushing	388
02-00009-004	V3002	Dismounting bushing	388
02-00010	V3432	Wheel bearing tool set, front, RENAULT Master	379
02-00010-001	V3433	Pressure sleeve	379, 383
03-00003-005	V3263	Screw M 22 x 60 mm	409, 411–412, 414–415
03-00004-001	V3262	Press frame	412
03-00005-001	V2937	Brake adjuster puller	412, 414–415
03-00006-001	V3264	Thrust rod Ø 31 mm	406, 409
03-00006-002	V3265	Thrust rod Ø 31 mm	406, 409
03-00006-006	V3266	Pressure pipe	406–407, 413
03-00006-007	V3267	Pressure pipe	406–407, 413
03-00006-009	V3261	Thrust rod Ø 29 mm	412
03-00006-010	V3260	Thrust rod Ø 29 mm	412
03-00006-011	V3259	Thrust washer Ø 54 mm	412
03-00006-013	V3238	Thrust washer Ø 59 mm	413–414
03-00006-014	V3237	Thrust washer Ø 63 mm	413–414
03-00006-015	V3236	Thrust washer Ø 50 mm	413–414
03-00006-016	V3235	Thrust washer Ø 44 mm	413–414
03-00006-017	V3234	Thrust washer Ø 63 mm	413–414
03-00006-018	V3233	Thrust washer Ø 57 mm	413–414
03-00006-020	V3232	Thrust rod Ø 31 mm	406, 409
03-00006-021	V3231	Pressure plate	409, 414

Wallmek No.	VIGOR No.	Designation	Page
03-00006-025	V3634	Spacer screw M 22	409
03-00006-026	V3440	Pressure sleeve	410
03-00006-027	V4634	Pressure pipe for V4565 · V4566	406–407
03-00006-028	V4563	Adapter plate for V4565 · V4566	406–407
03-00006-029	V4564	Pressure pipe 85 mm for V4565 · V4566	406–407
03-00006-030	V4562	Pressure sleeve for V4565 · V4566	406–407
03-00008-32T	V4601	Spring bolt set for SCANIA 32 tonnes	412
03-00008-45T	V4602	Spring bolt set for SCANIA 45 tonnes	412
03-00009	V4635	Spring bushing set, universal	413
03-00010	V2942	Bushing set for drawbars	413
03-00012	V2943	Supplementary set for changing the brake anchor bolts	405
03-00012-001	V3230	Pressure pipe	405
03-00012-002	V3229	Pressure sleeve	405
03-00012-003	V3227	Pressure sleeve	405
03-00013	V2936	Bushing set for SAF axle, 150 mm	413
03-00013-001	V3226	Assembly ring	413
03-00013-002	V3225	Dismounting/mounting ring	413
03-00013-003	V3224	Dismounting/mounting washer	413
03-00014-001	V2920	Ball joint puller, universal	404, 414–415
03-00015	V2873	Tractive and compressive hydraulic cylinder 8.5 tonnes	344, 376, 414–415
03-00015-001	V3009	Hydraulic cylinder	344
03-00015-006	V3010	Impact body with sealing ring	344
03-00015-012	V3011	Thrust rod, adjustable	344
03-00016-001	V3222	Pressure foot	409, 414–415
03-00016-32T	V4554	Wheel hub puller set for trucks · buses and trailers 32 tonnes	409
03-00016-45T	V4555	Wheel hub puller set for trucks · buses and trailers 45 tonnes	409
03-00020	V3434	Wheel bearing tool set for SCANIA	410
03-00020-001	V3437	Thrust washer	410
03-00020-002	V3438	Thrust washer	410
03-00020-003	V3439	Protective sleeve	410
03-00021-010	V4603	Universal pressure tool set 32 tonnes	414
03-00021-011	V4604	Universal pressure tool set 45 tonnes	415
03-00022	V3750	Wheel hub extractor for low-height trailers	411
03-00022-001	V3763	Plate	411
03-00022-002	V3764	Leg	411
03-00022-003	V3765	Thrust washer SAF Ø 73 mm	411
03-00025	V3678	Brake disc removal (floating), Volvo, RENAULT, DAF	404
03-00026	V4229	Tractive and compressive hydraulic cylinder 45 tonnes	346, 415
03-00026-001	V4242	Hydraulic cylinder 45 tonnes	346
03-00026-006	V4254	Impact body M 27	346
03-00026-012	V4251	Adjustable thrust block, M 30	346

Wallmek No.	VIGOR No.	Designation	Page
03-00027-002	V3762	Thrust rod M 24	410
03-00027-003	V4577	Thrust rod M 30 for V4500	410
03-00027-010	V3761	Base component with thread	410
03-00027-012	V3867	Adapter for base component with thread	410
03-00027-32T	V4499	Wheel hub puller commercial vehicle, 32 tonnes	410
03-00027-45T	V4500	Wheel hub puller commercial vehicle, 45 tonnes	410
03-00028	V2874	Tractive and compressive hydraulic cylinder 32 tonnes	346, 414
03-00028-001	V3216	Hydraulic cylinder	346
03-00031-001	V4550	Press frame for V4565 · V4566	406–407
03-00031-002	V4556	Plate with thread for V3750 · V4554 · V4555	409, 411–412
03-00031-200	V4569	King pin removal expansion set	408
03-00031-201	V4570	Support for V4569	408
03-00031-202	V4571	Extension for V4569	408
03-00031-203	V4575	Extension for V4569	408
03-00031-204	V4572	Extension for V4569	408
03-00031-205	V4573	Pressure plate for V4569	408
03-00031-206	V4574	Pressure plate for V4569	408
03-00031-220	V4605	King pins removal expansion set for MERCEDES-BENZ Actros and Atego	408
03-00031-221	V4610	Centring thrust block	408
03-00031-300	V4606	Steering knuckle removal expansion set MAN TGA · TGX and TGS	408
03-00031-303	V4607	Guide ring for V4605 · V4606	408
03-00031-32T	V4565	King pin removal tool set 32 tonnes, universal	406, 414
03-00031-45T	V4566	King pin removal tool set 45 tonnes, universal	407, 415
03-00032-001	V4545	Thrust rod M 30, length 30 mm, Ø 38 mm	407, 409
03-00032-002	V4546	Thrust rod M 30, length 140 mm, Ø 38 mm	407, 409
03-00032-003	V4547	Extension 50, Ø 38 mm for V4555 · V4566	407, 409
03-00032-004	V4548	Extension 70 mm, Ø 38 mm for V4555 · V4566	407, 409
03-00032-005	V4549	Extension 100 mm, Ø 38 mm for V4555 · V4566	407, 409
03-00032-101	V4609	Thrust rod M 30, length 137 mm, Ø 29 mm, for V4605 · V602	408, 412
03-00032-102	V4602-1	Thrust rod length 64 mm Ø 29 mm	412
03-00032-302	V4608	Pressure pipe	408
04-00003	V4255	Manometer	353
04-00007-001	V3287	Special nut M 16 x 1.5 mm	384
04-00007-004	V3013	Special nut M 14 x 2 mm	380, 384
04-00015-001	V3582	Protective cover	349
04-00016	V3612	Manometer	350
04-00021	V4218	Support set for hydraulic cylinders	347
04-00021-001	V4243	Bracket without shell	347

Wallmek No.	VIGOR No.	Designation	Page
04-00021-013	V4244	Clamp Ø 70 mm	347
04-00021-014	V4245	Clamp Ø 85 mm	347
04-00021-015	V4246	Clamp Ø 100 mm	347
04-00024	V5916	Ball joint ejector, hydraulic 4.5 tonnes	385
04-00028	V5916-XL	Ball joint ejector, hydraulic 8.8 tonnes	385
1-1090-02	V3199	Hydraulic cylinder	345
1-1090-03	V3217	Hydraulic cylinder	344
1011	V2928	Crank for brake disc	352
1012	V2927	Scraper	352
1030	V2847	Hydraulic foot pump	353, 372
1036	V2846	Hydraulic pump, pneumatic	353, 373
1062-01	V2857	Tool set for silent blocks VW · AUDI · SEAT · ŠKODA	391
1062-01-01	V3014	Dismounting/mounting washer	391
1062-01-02	V3015	Pressure pipe	391
1062-01-03	V3016	Mounting washer	391
1062-01-04	V3017	Dismounting washer	391
1064	V2922	Sliding hammer 5.2 kg	378
1066	V2871	Wheel hub removal tool set for V2922	378
1068	V2872	Adapter for sliding hammer V2922	378
1068-04	V2851	Adapter 2 1/4"-14 UNS (Klann thread) on 1 1/2"	348
1068-05	V2910	Adapter 1 1/2" to 2 1/2"-11 UN	348
1068-06	V2850	Adapter 2 1/4"-14 UNS (Klann thread) on 1 1/2"	348
1068-08	V3869	Adapter M 68 x 2 mm (Paschke Profitec thread) on 1 1/2"	349
1068-09	V3870	Adapter M 68 x 2 mm (Paschke Profitec thread) on 1 1/2"-11	349
1068-10	V4220	Adapter 2 3/4"-14 UNS (Klann thread) on 2 1/2"	349
1086-6	V3018	Impact body M 22 x 2.5 mm	345-346
1090-02-WAL	V2854	Tractive and compressive hydraulic cylinder 22 tonnes	345, 372-373, 375
1090-03	V2869	Hydraulic cylinder 14 tonnes	344
1090-14	V3256	Silent block bushing set, rear, BMW X5, E53	390
1090-14-A6	V3302	Washer with thread	390
1090-14-B6	V3019	Retaining ring	390
1090-14-D6	V3020	Mounting washer	390
1090-15-B	V3021	Pressure sleeve	382, 390
1090-15-B3	V3022	Retaining ring	390
1090-15-C	V3023	Thrust washer	390
1090-15-D	V3024	Retaining washer	390
1090-18-D5	V3025	Mounting washer	390
1090-18-E5	V3026	Pressure pipe	390
1090-18-E6	V3027	Thrust washer	390
1090-20-02	V3033	Support disc	359, 378
1090-20-04	V3034	Support disc	359, 378

Wallmek No.	VIGOR No.	Designation	Page
1090-20-06	V3035	Support disc	359, 378-379
1090-20-08	V3036	Support disc	359, 378
1090-20-BX	V3058	Thrust washer	379
1090-20-M	V3060	Counterholder	355-356, 382
1090-20-R1	V3061	Pressure pipe	379, 382
1090-20-T10	V3063	Bearing washer	359, 379
1090-20-T16	V3067	Bearing washer	379
1090-20-T18	V3068	Bearing washer	382
1090-20-T20	V3069	Bearing washer	382
1090-20-T21	V3070	Bearing washer	356
1090-20-T22	V3071	Bearing washer	356
1090-22	V3072	Press frame	354, 379
1090-25-10	V2864	Thrust washer, conical, universal	357, 359, 371
1090-25-11	V2861	Thrust washer (installation) VW · AUDI · SEAT · ŠKODA	361
1090-25-12	V2862	Thrust washer (installation) VW	361, 379
1090-25-13	V2863	Mounting ring FORD · MAZDA · Volvo	361
1090-25-14	V2859	Thrust washer (installation) FORD · MAZDA · Volvo	361
1090-25-15	V6824	Half shell set for 92 mm compact wheel bearings	357
1090-26	V2845	Hub and bearing shell	354
1090-26-01	V3039	Thrust washer	354, 380
1090-26-02	V3040	Pressure pipe	354, 380
1090-30	V2849	Device for the removal of drive shafts, 4- and 5-holes	375, 377
1090-30-4	V3147	Axle drive shaft 4 holes, bolt circle 92-120 mm	377
1090-30-5	V3148	Axle drive shaft 5 holes, bolt circle 98-131 mm	377
1090-32	V3207	Set of drawbars, flange nuts and adapters	347
1090-39	V2886	Rear axle bushing tool set VW · AUDI · SEAT · ŠKODA	389
1090-39-06	V3213	Dismounting bushing	389
1090-39-08	V3214	Mounting bushing	389
1090-39-09	V3215	Assembly ring	389
1090-39-10	V3212	Dismounting ring	389
1090-54-01	V3045	Pressure sleeve	388
1090-54-02	V3046	Pressure sleeve	388
1090-54-03	V3047	Pressure sleeve	388
1090-54-04	V3048	Mounting bushing	388
1090-54-05	V3049	Dismounting ring	388
1090-54-06	V2915	Supporting joint dismounting bushing, MERCEDES-BENZ	388
1090-54-10	V2913	Supporting joint tool set MERCEDES-BENZ	388

Wallmek No.	VIGOR No.	Designation	Page
1090-54-11	V2914	Stabilizer ball joint tool set MERCEDES-BENZ	388
1090-54-12	V2917	Bushing set for control arm, rear MERCEDES-BENZ	392
1090-54-12-001	V3050	Dismounting ring	392
1090-54-12-002	V3051	Mounting bushing	392
1090-54-12-003	V3052	Pressure pipe	392
1090-54-12-004	V3044	Retaining ring	392
1090-55-B	V2858	Press frame	405
1090-60-01	V3053	Plate with thread	370, 386-387
1090-60-03	V3055	Support	386
1090-60-04	V3056	Screw M 16 x 40 mm	370, 386-387
1090-60-06	V3142	Adapter plate	386
1090-61-01	V2909	Thrust block	386
1090-61-02	V2908	Thrust block	386
1090-61-03	V2907	Thrust block	386
1090-62-01	V2906	Thrust block	386
1090-62-02	V2905	Thrust block	386
1090-62-03	V2904	Thrust block	386
1090-62-08	V2903	Thrust block	386
1090-64-01	V2902	Thrust block	386
1090-66-01	V2901	Thrust block	386
1090-66-03	V2900	Thrust block	386
1090-66-04	V2899	Thrust block	386
1090-66-05	V2898	Thrust block	386
1090-66-06	V2897	Thrust block	386
1090-66-07	V2896	Thrust block	386
1090-66-08	V2895	Thrust block	386
1090-66-09	V2894	Thrust block	386
1090-66-10	V2893	Thrust block	386
1090-68-01	V2892	Thrust block	386
1090-68-02	V2891	Thrust block	386
1090-68-03	V3094	Pressure sleeve	389
1090-68-04	V3093	Pressure sleeve	389
1090-68-05	V3095	Pressure sleeve	389
1090-68-20	V2884	Rear axle bushing tool set RENAULT	389
1090-69 + 1090-60-06	V2885	Press frame with open plate with adapter to close the plate	386
1090-69-20-B	V5902	Rear axle bushing tool set	370, 389
1091-10	V2879	Wheel bearing tool set, front, for FORD	380
1091-10-04	V3088	Support disc	379-380, 382-383
1091-11	V3087	Wheel hub tool	380
1091-15	V2880	Wheel bearing tool set, rear CITROËN · FIAT · PEUGEOT	382
1091-15-01	V3090	Adapter ring	382

Wallmek No.	VIGOR No.	Designation	Page
1091-17	V2889	Wheel bearing tool set, front for CITROËN · FIAT · PEUGEOT	381
1091-17-01	V3105	Pressure ring	381
1091-17-02	V3106	Thrust washer	379, 381-383, 413
1091-17-03	V3107	Pressure pipe	379, 381-383, 413
1091-17-04	V2881	Bearing washer for wheel bearing tool set, front, for CITROËN · FIAT · PEUGEOT	379-383
1091-17-05	V3108	Bearing washer	381
1091-17-06	V3109	Counterholder	381
1091-17-07	V2882	Support disc for wheel bearing tool set, front, for CITROËN · FIAT · PEUGEOT	381-382
1091-17-08	V3149	Pressure pipe	379-381, 383
1091-17-09	V3091	Support disc	381
1091-17-M22	V3092	Striker nut	346, 410
1091-18	V2883	Pressure ring for wheel bearing tool set, front, for CITROËN · FIAT · PEUGEOT	379, 381, 383
1091-21-04	V3115	Spacer screw	379
1091-22	V2875	Wheel bearing tool set, front, for NISSAN · OPEL/VAUXHALL · RENAULT	382
1091-22-01	V3114	Bearing washer	382
1091-23	V2888	Wheel bearing tool set, front, for NISSAN · OPEL/VAUXHALL · RENAULT	383
1091-23-01	V3113	Pressure ring set Ø 89 mm	383
1091-23-02	V3112	Bearing shell	383
1091-23-03	V3110	Thrust washer	379, 383
1091-23-04	V3111	Thrust washer	383
1091-24-001	V2951	Wheel bolt change tools for trucks, universal	405
1091-24-001-01	V3246	Mounting bushing	405
1091-24-001-02	V3245	Counterholder	405
1091-24-001-03	V3244	Dismounting pipe	405
1091-24-001-04	V3243	Dismounting pipe	405
1091-24-001-05	V3242	Dismounting bushing	405
1091-24-001-06	V3241	Thrust rod, adjustable	405
1091-24-001-08	V3239	Dismounting pipe	405
1091-28	V2890	Drive shaft tool, 5 holes, for transport vehicles	380, 382, 384
HSC2008-1116	V4353	Spring plate Ø 150-240 mm	393, 395
HSC2008-1117	V4352	Spring plate Ø 70-160 mm	393, 395
HSC2008-1118	V4354	Spring plate Ø 150-240 mm with locking element	393, 395
HSC2008-1119	V4476-1	Adapter ring for OPEL/VAUXHALL Insignia	393
HSC2018	V4476N	Hydraulic safety spring vice including 10 spring plates	394
RES1030-01	V3614	Gasket set	353

References Wallmek / VIGOR



Wallmek No.	VIGOR No.	Designation	Page
RES1030-02	V3120	Hydraulic hose	353
RES1090-01-09	V3123	Pressure foot	345
RES1090-01-10	V3124	Thrust rod, adjustable	344-345
RES1090-01-10	V4568	Thrust rod, adjustable, 92 mm, M 24	345
RES1090-01-12	V3129	Adjustable thrust block	345, 388
RES1090-01-13	V3125	Protection ring for thread 1.1/2"	345
RES1090-02-04	V3134	Pressure shaft	345
RES1090-05-02	V3130	Adjustable thrust block	345-346
RES1090-05-04	V3131	Protection ring for thread 2.5	346
RES4009	V4596	Adapter	347
RES4010	V3135	Adapter	347, 390, 392
RES4011	V3219	Adapter	347
RES4012	V3209	Adapter	347
RES4014	V3210	Drawbar	347
RES4015	V3220	Drawbar	347
RES4016	V3136	Drawbar	347, 390, 392
RES4021	V3137	Flange nut	347, 391-392
RES4022	V3208	Flange nut	347
RES4023	V3275	Flange nut	347

Wallmek No.	VIGOR No.	Designation	Page
RES4024	V3126	Flange nut	345, 347, 351, 378, 413-414
RES4025	V3132	Flange nut	346-347, 376, 410
RES4026	V3127	Drawbar	345, 347, 390, 413-414
RES4027	V3133	Drawbar	346-347, 376
RES4028	V3138	Drawbar	391
RES4029	V3139	Drawbar	390
RES4030	V3140	Drawbar	378
RES4034	V3431	Drawbar	410, 413
RES4035	V4252	Flange nut M 27	346
RES4036	V4253	Drawbar M 27	346
RES4039	V4597	Adapter	347
RES4304	V3141	(CEJN-) quick coupler connection	353
RES4305	V3012	(CEJN) fitting, hydraulic	344
RES4306	V3128	(CEJN) fitting, hydraulic	344-346
RES4307	V6591	Adapter 3/8" outside thread, on CEJN / cylinder	350
RES4308	V6592	Adapter 3/8" inside thread, on CEJN / pump	350

V4481-XD, EAN 4047728**066488**

VIGOR 1000 XD

Extra-deep tool trolley without assortment,
with stainless steel worktop



58

V4481-XD/469, EAN 4047728**068512**

VIGOR 1000 XD

Extra-deep tool trolley with assortment
and stainless steel worktop



469

48

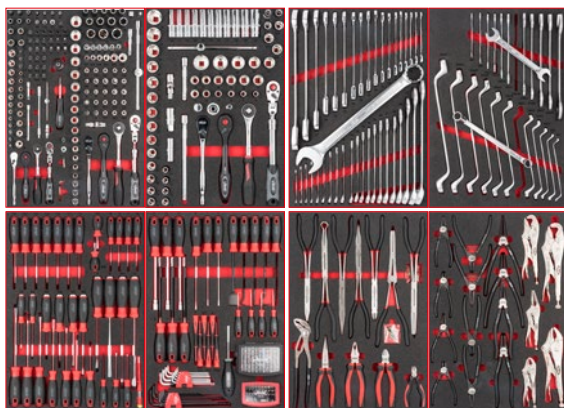

Document holder



VIGOR No.	EAN 4047728+
V6393-S	069205
V6393	069519

62

V6395, EAN 4047728**070522**

Waste bin



61

V4481-XD/775, EAN 4047728**068529**

VIGOR 1000 XD

Extra-deep tool trolley with assortment
and stainless steel worktop



775

49

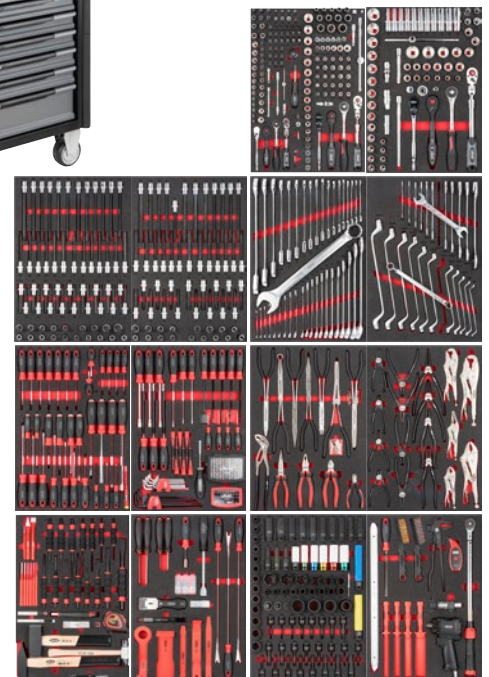

V6396, EAN 4047728**069601**
Screwdriver holder



61

V6397, EAN 4047728**069793**
Holder for paper reel, pivotable



62

V6688, EAN 4047728**070249**
Separation sheet set
VIGOR 500 N and VIGOR 1000

5

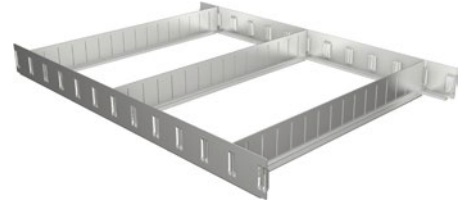

64

V6688-XL, EAN 4047728**070096**
VIGOR 1000 XL
separation sheet set

6

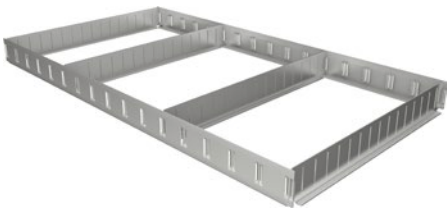

65

V6688-XD, EAN 4047728**070089**
VIGOR 1000 XD
separation sheet set

6

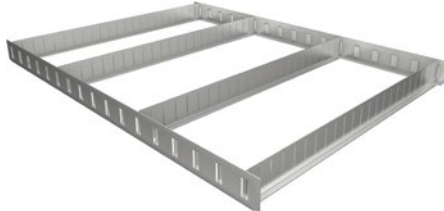

65

V6687/5, EAN 4047728**070072**
Cross member set for
VIGOR 1000 XD

5



65

V6686/5, EAN 4047728**070065**
Cross member set for
VIGOR 500 N, 1000
and 1000 XL

5



65

Separation sheet set

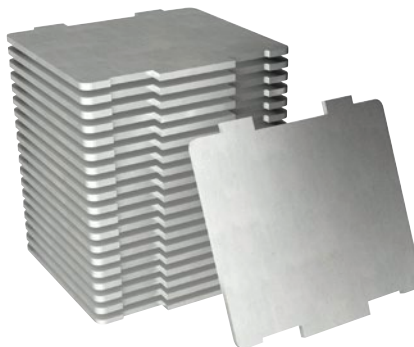

VIGOR No.	Designation		EAN 4047728+
V6685-1/20	Separation sheet set, small 45 mm	20	070133
V6685-2/20	Separation sheet set, medium 91 mm	20	070126
V6685-3/10	Separation sheet set, large 137 mm	10	070119
V6685-4/10	Separation sheet set, extra large 183 mm	10	070102

66

V6000-030, EAN 4047728**070140**
Drawer lower cabinet, 3 drawers



82

V6000-030XL, EAN 4047728**070294**
Drawer lower cabinet, 3 drawers



82

V6000-031, EAN 4047728**070157**
Drawer lower cabinet, 5 drawers



83

V6000-031XL, EAN 4047728**070300**
Drawer lower cabinet, 5 drawers



83

V6000-01, EAN 4047728**048248**
Drawer lower cabinet, 7 drawers



83

V6000-01XL, EAN 4047728**070317**
Drawer lower cabinet, 7 drawers



84

V6000-019, EAN 4047728**063883**
Tool trolley for storage system, 7 drawers



84

V6000-019XL, EAN 4047728**070683**
Tool trolley for storage system, 7 drawers



84

V6000-032, EAN 4047728**070171**
Drawer lower cabinet, 8 drawers



85

Overview of New Products



V6000-032XL, EAN 4047728070324
Drawer lower cabinet, 8 drawers



85

V6000-033, EAN 4047728070195
Lower cabinet for waste



85

V6000-033XL, EAN 4047728070331
Lower cabinet for waste



86

V6000-02XL, EAN 4047728070355
Lower cabinet with double-hinged door



86

V6000-03XL, EAN 4047728070362
Cabinet with double-hinged door, high



88

V6000-04XL, EAN 4047728070379
Wall cabinet



88

Worktop, wood



89

VIGOR No.	Designation	EAN 4047728+
V6000-013	Worktop, wood, small – width 676 mm	054928
V6000-022	Worktop, wood, small – width 861 mm	069823
V6000-08	Worktop, wood, medium – width 1357 mm	048415
V6000-023	Worktop, wood, medium – width 1725 mm	069854
V6000-021	Worktop, wood, large – width 2036 mm	069878
V6000-024	Worktop, wood, large – width 2588 mm	069892
V6000-025	Worktop, wood combined, medium – width 1541 mm	069915
V6000-026	Worktop, wood combined, large – width 2215 mm	069939
V6000-027	Worktop, wood combined, large – width 2404 mm	069953

Worktop, stainless steel

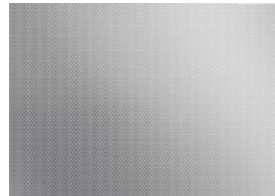

89

VIGOR No.	Designation	EAN 4047728+
V6000-013-X	Worktop, stainless steel, small – width 676 mm	069816
V6000-022-X	Worktop, stainless steel, small – width 861 mm	069830
V6000-08-X	Worktop, stainless steel, medium – width 1357 mm	069847
V6000-023-X	Worktop, stainless steel, medium – width 1725 mm	069861
V6000-021-X	Worktop, stainless steel, large – width 2036 mm	069885
V6000-024-X	Worktop, stainless steel, large – width 2588 mm	069908
V6000-025-X	Worktop, stainless steel combined, medium – width 1541 mm	069922
V6000-026-X	Worktop, stainless steel combined, large – width 2215 mm	069946
V6000-027-X	Worktop, stainless steel combined, large – width 2404 mm	069960

Worktops, five corners



VIGOR No.	Designation	EAN 4047728+
V6000-012	Five-corner wooden worktop for combining two storage systems	054911
V6000-012-X	Five-corner stainless steel worktop for combining two storage systems	069977

89

V5202, EAN 4047728068987 Socket set, super flat

6.3 1/4

25



132

V3734N, EAN 4047728056427

Socket set

6.3 1/4

23



133

V2414N, EAN 4047728056434

Socket set

6.3 1/4

46



133

V2305N, EAN 4047728056441

Socket set

10 3/8

61



143

V6017, EAN 4047728064361

TORX® screwdriver socket set

10 3/8

32



144

V6018, EAN 4047728065894

Screwdriver socket set for screws with internal serration (XZN)

10 3/8

26



144

V6019, EAN 4047728065900

Screwdriver socket set for inside hexagon screws

10 3/8

30



144

Overview of New Products



V7202, EAN 4047728068888
Socket set, super flat

12²⁵ 1/2

24



155

V2460N, EAN 4047728056458
Socket set

12²⁵ 1/2

25



156

V7017, EAN 4047728064705
Impact screwdriver socket set for internal TORX® profile

12²⁵ 1/2

8



161

V7018, EAN 4047728066846
Impact screwdriver socket set for internal serration profile (XZN)

12²⁵ 1/2

8



161

V7019, EAN 4047728066372
Impact screwdriver socket set for inside hexagon profile

12²⁵ 1/2

8



161

V2318N, EAN 4047728059299
Socket set

20 3/4

21



172

V1706N, EAN 4047728056465
Socket set

6.3 1/4 12²⁵ 1/2 8 3/8

94



179

V2461N, EAN 4047728056472
Socket set

6.3 1/4 8 3/8 6.3 1/4 10 3/8 12²⁵ 1/2

172



180

V3277N, EAN 4047728056489
Socket set

8 3/8 6.3 1/4 10 3/8 12²⁵ 1/2

212



181

Telescopic reversible ratchet with hinge joint



VIGOR No.	■	EAN 4047728+	X
V6614	6-3 1/4	066440	135
V6638	10 9/16	066457	145
V6612	12-5 1/2	066464	163

V4944-XS, EAN 4047728069557
Fine-tooth reversible ratchet, extra-short design



136

Adjustable wrench



VIGOR No.	EAN 4047728+
V6048	069625
V6049	069618

194

V6752/12, EAN 4047728068048
Double joint ratcheting combination wrench set

12



191

V1371, EAN 4047728069687
Removal lever set, 11 pieces

11



225

V3738-S, EAN 4047728069540
Grip pliers with curved jaws



211

V6799, EAN 4047728067997
Flexible hose clamp set

3



215

V6220/4, EAN 4047728066006
Flat chisel set

4



223

Centre punch



VIGOR No.	EAN 4047728+
V6210-4	065948
V6210-10	065931

224

Cape chisel



VIGOR No.	EAN 4047728+
V6230-5	065986
V6230-7	065993

224

V4310N, EAN 4047728062817
Release lever



226

Overview of New Products



V6807-4, EAN 4047728067713
Brass wire brush, 4 rows



231

V6809-4, EAN 4047728067720
Steel wire brush, 4 rows



231

V6802, EAN 4047728067645
Wire end brush



232

Cup brush, coarse



232

VIGOR No.	EAN 4047728+
V6800-50	067621
V6800-75	067638

Wheel brush



232

VIGOR No.	EAN 4047728+
V6803-75	067652
V6803-100	067669

V6805, EAN 4047728067706
Bevel brush



233

V6806, EAN 4047728067676
Wheel brush, coarse



233

V6801-65, EAN 4047728067683
Cup brush



233

V6804, EAN 4047728067690
Wheel brush



233

V6917, EAN 4047728069175
Brake line ratcheting tube cutter



234

V1740, EAN 4047728068673
Magnetic pick-up tool, semi-flexible



254

Flap disc set 115 mm



VIGOR No.	X	EAN 4047728+
V6810-115K40	10	067737
V6810-115K60	10	067744
V6810-115K80	10	067751

261

Flap disc set 125 mm



VIGOR No.	X	EAN 4047728+
V6810-125K40	10	067782
V6810-125K60	10	067775
V7010-125K80	10	070690

261

Cut-off wheel set



VIGOR No.	X	EAN 4047728+
V6811-76	25	070287
V6811-115	10	067287
V6811-125	10	067768

261

V6899, EAN 4047728068994 Impact wrench



245

V6554, EAN 4047728065542 Air ratchet



246

V6906, EAN 4047728069069 Die grinder set, mini

15



247

V6906-10, EAN 4047728069571 Grindstone set

10



247

V6903, EAN 4047728069038 Angle grinder



248

V6904, EAN 4047728069045 Drilling machine



248

Overview of New Products



V6905, EAN 4047728069052
Tyre inflator



249

V5677, EAN 4047728056779
Magnetic cup with plastic frame



256

V6468, EAN 4047728064682
Nozzle adjusting tool with magnet



256

V6742, EAN 4047728067423
Magnetic tool holder



256

V6605, EAN 4047728066051
Fender cover



257

V6606, EAN 4047728066068
Reusable seat cover



257

V6435, EAN 4047728064354
Work gloves



257

V6973, EAN 4047728069731
Mechanic's creeper



258

V6973-1, EAN 4047728069748
Replacement castor
for mechanic's creeper

258



V6299, EAN 4047728062039
Non-contact infrared thermometer



260

V6741, EAN 4047728067416
Puller set for ignition coils



269

V4415, EAN 4047728062114
Oil filter wrench,
115 – 140 mm, universal



296

Oil drain pan



VIGOR No.	EAN 4047728+
V6300-5	068963
V6300-8	068970
V6300-13	068956

299

V3760N, EAN 4047728066310
Brake piston
readjusting tool set



306

V6029, EAN 4047728069786
Hydraulic service jack 3 tonnes



323

V7039, EAN 4047728070393
Impact socket set

12 1/2



321

V6452, EAN 4047728064521
Shock absorber tool set



339

V6956, EAN 4047728069564
Universal axle lever



339

Overview of New Products



V7061, EAN 4047728070614
Screw set SUBARU rear wheel bearings



361

V7050, EAN 4047728070508
Removal tool for screwed 4-hole wheel hubs/ wheel bearings with special brake guard



363

V5549-1, EAN 4047728070492
V4700-L multibox with compact wheel bearing/ wheel hub expansion set



369

V5741N, EAN 4047728070485
V4700-XL multibox, for FORD, MAZDA, Volvo longitudinal strut and wishbone bushing



370

V5916-XL, EAN 4047728066471
Ball joint ejector, hydraulic 8.8 tonnes



385

V5916, EAN 4047728059817
Ball joint ejector, hydraulic 4.5 tonnes



385

V4476N, EAN 4047728068000
Hydraulic safety spring vice including 10 spring plates



394

VIGOR 1000 XL Special
Mobile work bench with specialty tool assortment



VIGOR No.		EAN 4047728+	
V7026	115	070263	397
V7026-1	116	070386	398
V7026-2	117	070478	399







Tool Trolleys and Factory Equipment

Tool trolleys with assortment	37–49
-------------------------------	-------

Mobile work benches with assortment	50–51
-------------------------------------	-------

Service trolley	52
-----------------	----

Tool trolleys without assortment	53–59
----------------------------------	-------

Mobile work bench without assortment	60
--------------------------------------	----

Accessories for tool trolleys	61–71
-------------------------------	-------









Work benches, tool cabinets, accessories	72–75
--	-------

Wall unit systems	76–88
-------------------	-------

Accessories for wall unit systems	89–91
-----------------------------------	-------





VIGOR No:	h x w x d	Total loading capacity kg	Worktop	Insert size	Insert dimension	Number of drawers	Loading capacity per drawer kg	Drawer slide-out	Drawer lock
V5489	 1000x677x459 mm	400	Removable foam mat	3/3+	563x393 mm	7	20	100%	Central locking
V1902	 375x723x459 mm	/	/	3/3+	563x393 mm	3	25	100%	Central locking
V1901	 1000x723x459 mm	500	Solvent resistant plastic material	3/3+	563x393 mm	7	25	100%	Central locking
V1970	 1375x723x459 mm	500	Solvent resistant plastic material	3/3+	563x393 mm	10	25	100%	Central locking
V4481	 1000x907x481 mm	500	Solvent resistant plastic material	4/3+	750x393 mm	8	25	100%	Central locking
V4481-X	 1017x940x514 mm	500	Stainless steel worktop	4/3+	750x393 mm	8	25	100%	Central locking
V4481-XD	 976 x 686 x 1017 mm	500	Stainless steel worktop	4/3+	786x563 mm	8	30	100%	Central locking
V4813	 1000 x 1091 x 481 mm	1000	Wooden worktop with collecting groove	3/3+	563x393 mm	8	40	100%	Central locking
V4814	 1000x907x481 mm	1000	Wooden worktop with collecting groove	4/3+	750x393 mm	4	40	100%	Central locking

Tool trolleys with assortment



V2379N, EAN 4047728055444

VIGOR 500N

Tool trolley with assortment



RAL
 9005 7004

Assortment contents:

Product video:

164 **V1000 3/3+**

7x

5x

2x

1000 mm
 459 mm
 677 mm

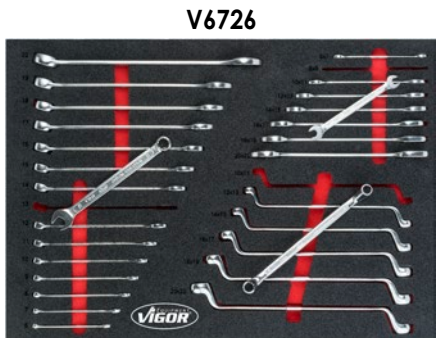

V2712N, EAN 4047728055451

VIGOR 500N

Tool trolley with assortment



RAL 9005 7004

Assortment contents:

Product video:

228 **V1000 3/3+**

7x 20 kg

5x 569x398x75 mm

2x 569x398x154 mm

61 kg 400 kg

1000 mm

459 mm

677 mm

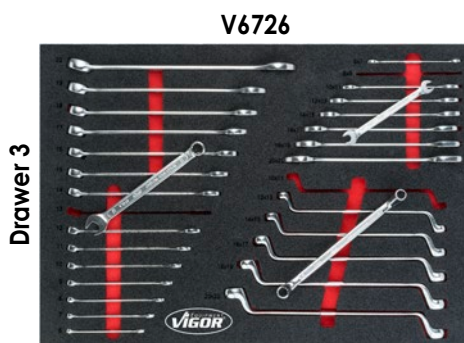

Tool trolleys with assortment



V4219, EAN 4047728042192

VIGOR 1000

Tool trolley with assortment



RAL
 9005 7004

Assortment contents:

Product video:

248 **V1000 3/3+**

7x

5x 2x

569x398x75 mm 569x398x154 mm

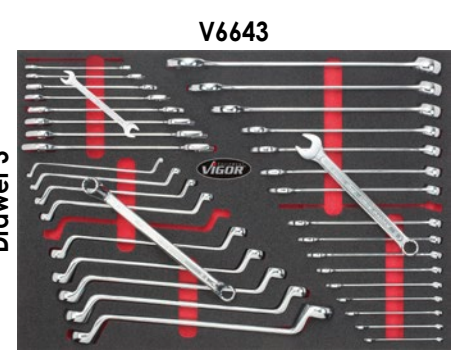
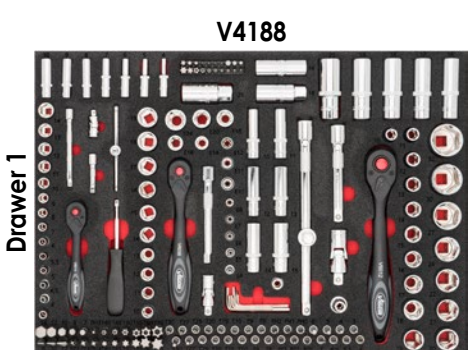

V5055, EAN 4047728050562

VIGOR 1000

Tool trolley with assortment



RAL: 9005 (Black), 7004 (Grey)
 Assortment contents: [QR Code]
 Product video: [QR Code]
317 V1000 3/3+

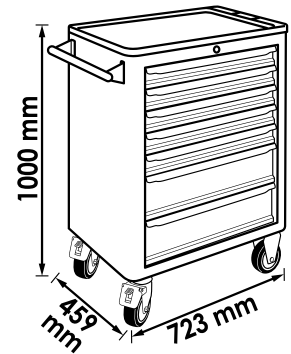
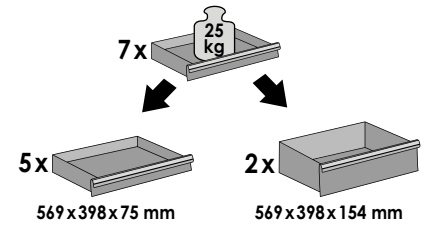
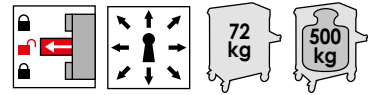

V4188

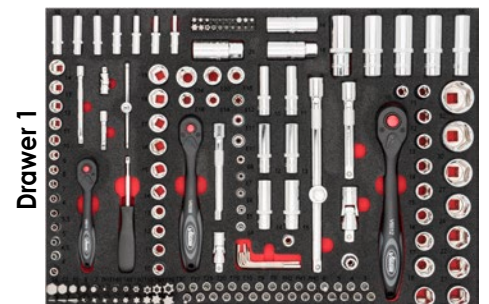

Drawer 1

V4753

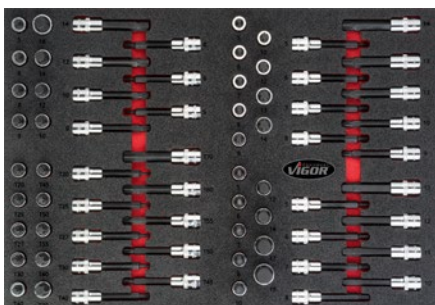

Drawer 2

V6643

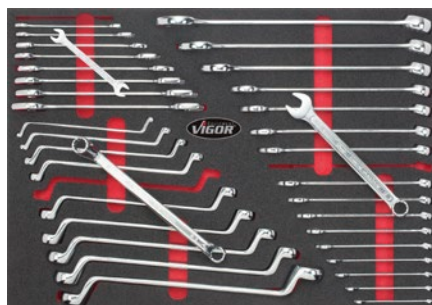

Drawer 3

V5634



Drawer 4

Tool trolleys with assortment



V4560, EAN 4047728045605

VIGOR 1000

Tool trolley with assortment



RAL
 9005 7004

Assortment contents:
 72 kg 500 kg
 7x 25 kg
 5x 569x398x75 mm
 2x 569x398x154 mm

Product video:
 344 V1000 3/3+

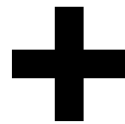

V4188

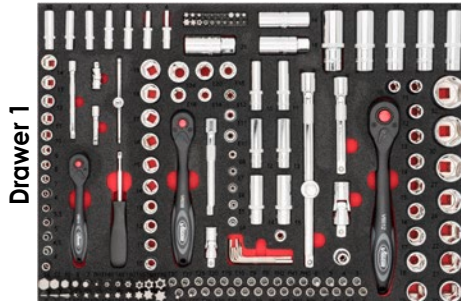

V2837

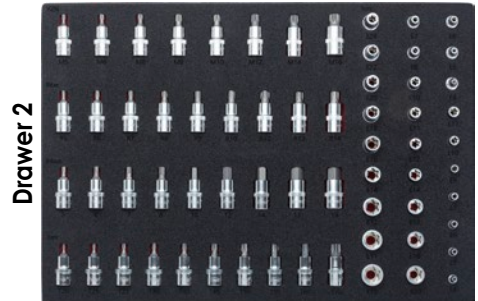

V4230



V6643

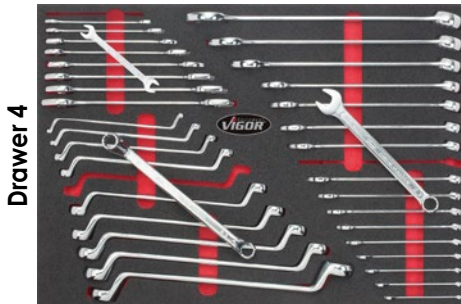

V5637



V4561, EAN 4047728045810

VIGOR 1000

Tool trolley with assortment and tool chest

RAL: 9005 7004

Assortment contents:

Product video:

344 **V1000 3/3+**

72 kg 500 kg

10x 25 kg 29 kg

8x 569x398x75 mm

2x 569x398x154 mm

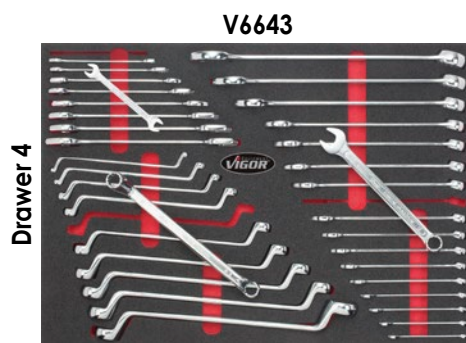
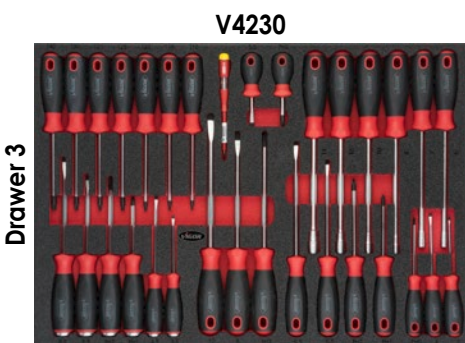
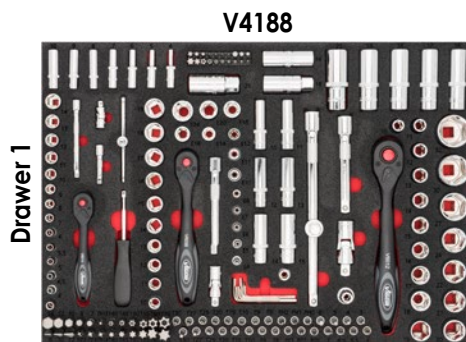
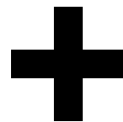

Tool trolleys with assortment



V4497, EAN 4047728044974

VIGOR 1000 XL

Tool trolley with stainless steel worktop and basic assortment for VW and AUDI

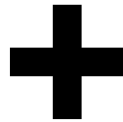

RAL
 9005 7004

Assortment contents:
 [QR Code]

Product video:
 [QR Code]

255 **V1000 3/3+**

8x 25 kg
 7x 753x398x75 mm
 1x 753x398x154 mm

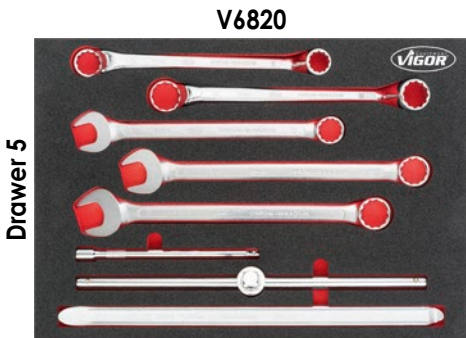
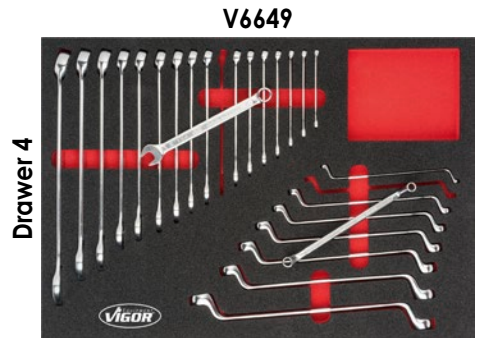
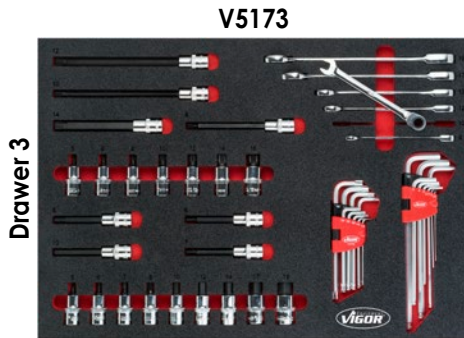
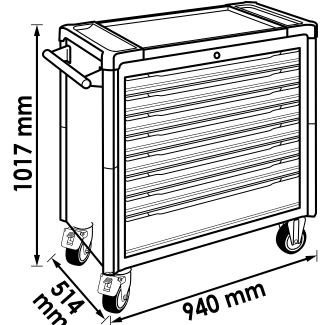

V4542, EAN 4047728045421

VIGOR 1000 XL

Tool trolley with assortment and plastic worktop

RAL 9005 7004

Assortment contents:

Product video:

375 **V1000 4/3+**

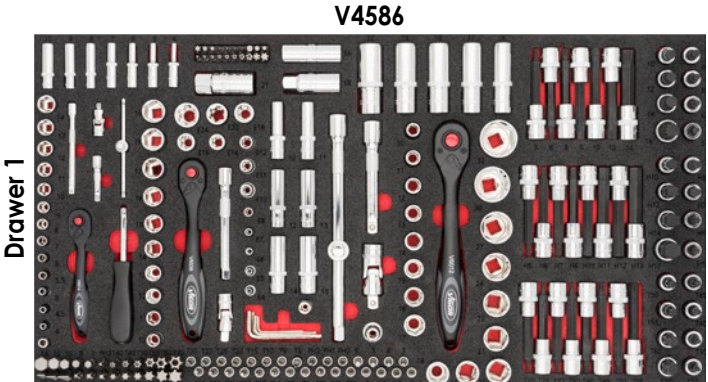
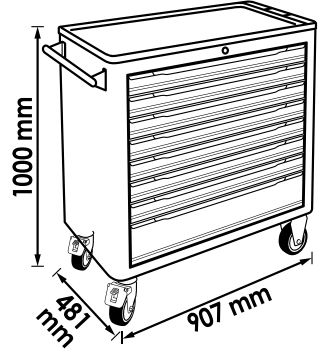
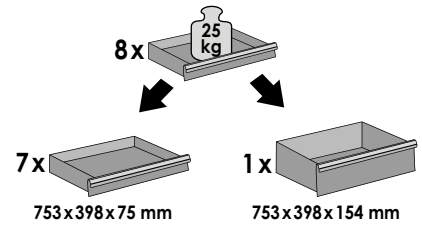

Tool trolleys with assortment



V5434, EAN 4047728054348

VIGOR 1000 XL

Tool trolley with assortment and plastic worktop



RAL 9005 7004

Assortment contents:

Product video:

499

V1000 4/3+

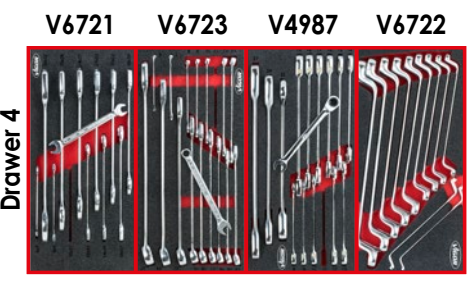
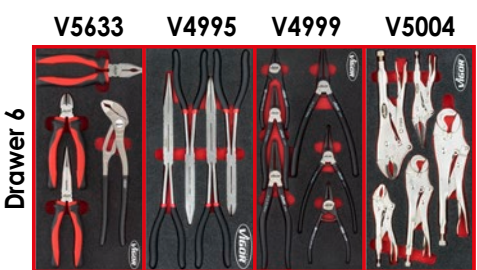
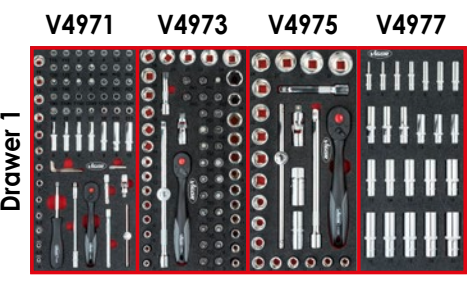
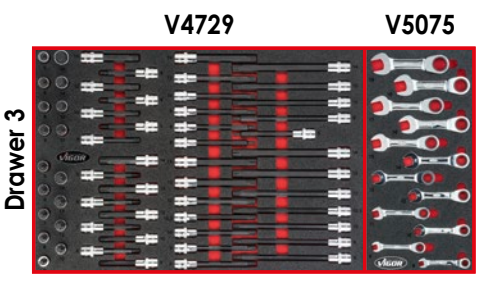
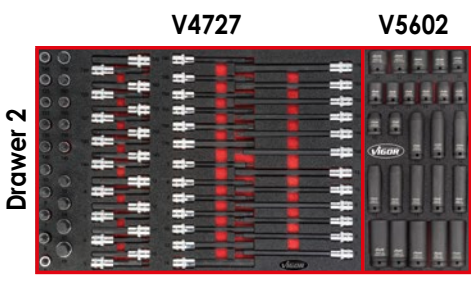
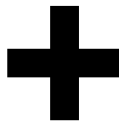
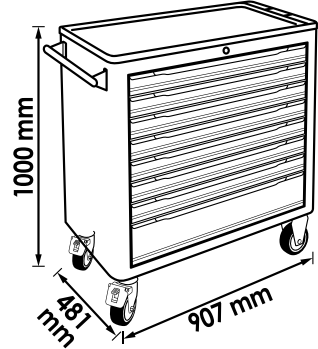
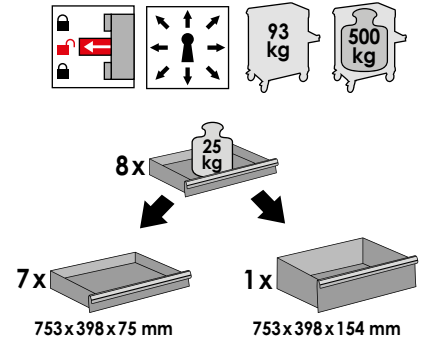

V4481-X/375, EAN 4047728062350

VIGOR 1000 XL

Tool trolley with assortment and stainless steel worktop



Assortment contents:

RAL 9005 7004

QR code: 375

V1000 4/3+

84 kg

500 kg

8x 25 kg

7x 753x398x75 mm

1x 753x398x154 mm

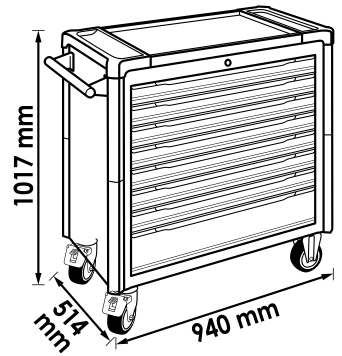

V4586

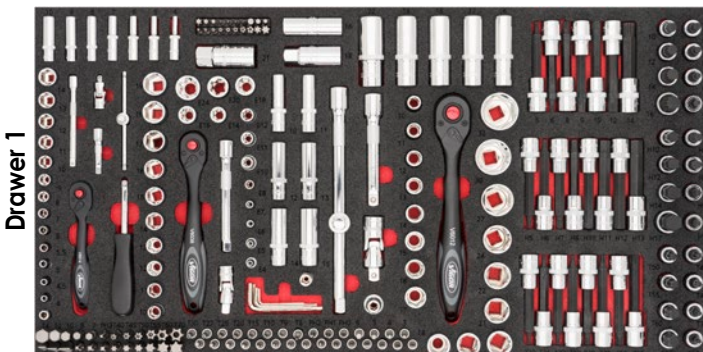

V6650



V5170



V5638



Tool trolleys with assortment



V4481-X/499, EAN 4047728062367

VIGOR 1000 XL

Tool trolley with assortment and stainless steel worktop



Assortment contents:

RAL 9005 7004

499 V1000 4/3+

84 kg 500 kg

8x 25 kg

7x 753x398x75 mm 1x 753x398x154 mm

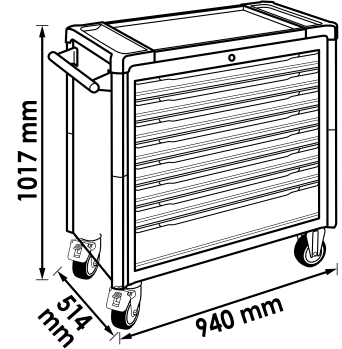

V4971 V4973 V4975 V4977



V6721 V6723 V4987 V6722



V4727 V5602



V4729 V5075

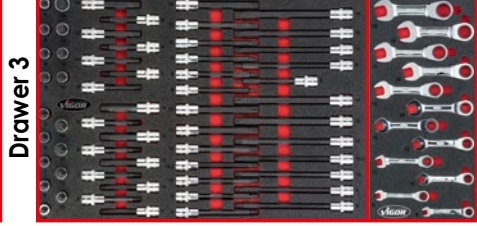

V5170



V5633 V4995 V4999 V5004

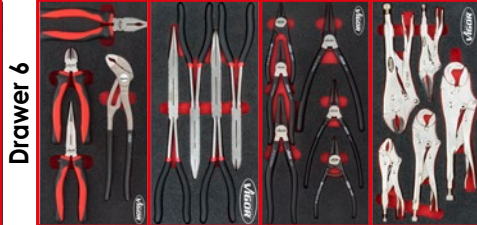

V5006 V5017 V5070 V5072



V4481-XD/469, EAN 4047728068512

VIGOR 1000 XD

Extra-deep tool trolley with assortment and stainless steel worktop

NEW



RAL
9005 7004

Assortment contents:
469

V1000 XD 6/3+
3/3+ V1000 V1000

114 kg 500 kg

V4481-EXTRA DEEP

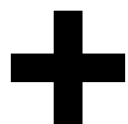
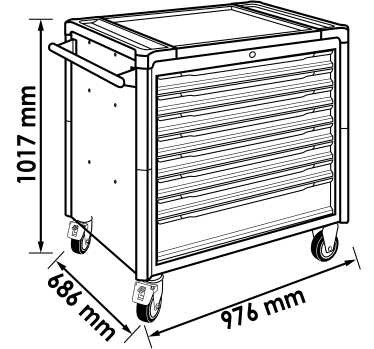
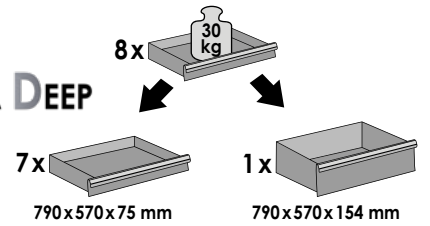

	V6821	V6822	V6807	V6808
Drawer 1				
Drawer 2				
Drawer 3	V6813	V6814	V6815	V6816
Drawer 4				

Tool trolleys with assortment



V4481-XD/775, EAN 4047728068529

VIGOR 1000 XD

Extra-deep tool trolley with assortment and stainless steel worktop

NEW



Assortment contents:

RAL 9005 7004

QR code

775

V1000 XD 6/3+ 3/3+ V1000 V1000

114 kg

500 kg

V4481 - EXTRA DEEP

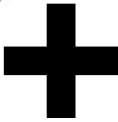
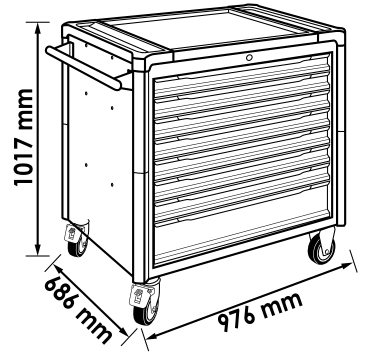
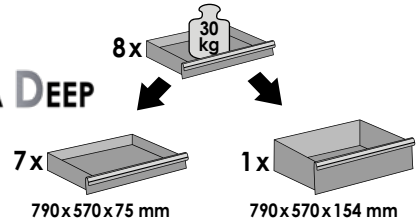

V6821

V6822

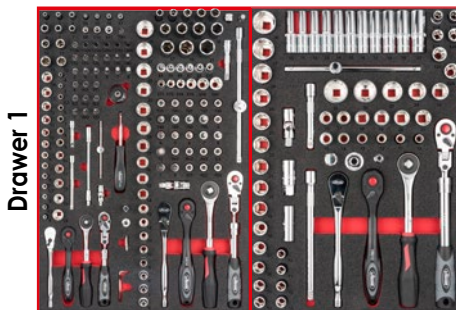

Drawer 1



V6809

V6810

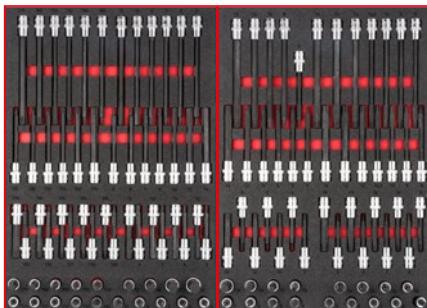

Drawer 2

V6807

V6808

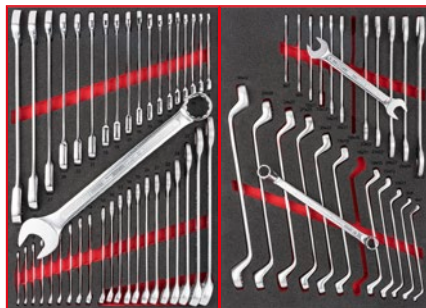

Drawer 3

V6813

V6814



Drawer 4

V6815

V6816

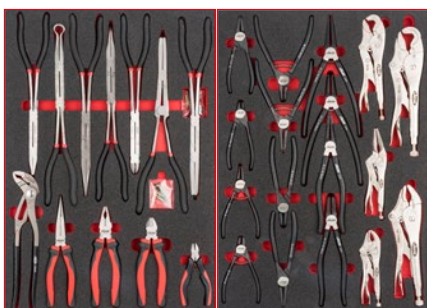

Drawer 5

V6817

V6818

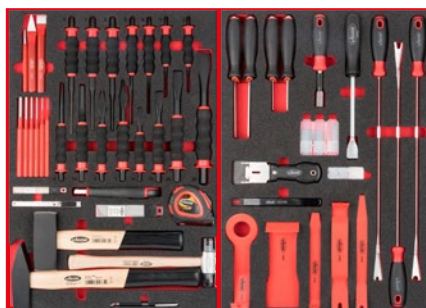

Drawer 6

V6811

V6812

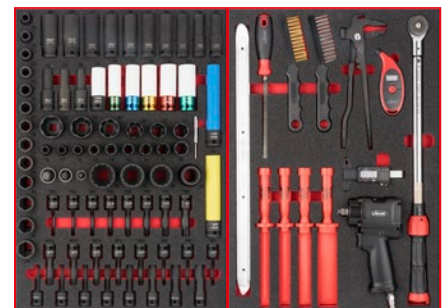

Drawer 7



V5156, EAN 4047728051569

Work bench VIGOR 1000

Mobile work bench with assortment



RAL
 9005 7004

Assortment contents:
 8x 40 kg
 7x 569x397x75 mm
 1x 569x397x154 mm

Product video:
 256 V1000 3/3+

115 kg 1000 kg

1210 mm 520 mm 1000 mm 481 mm 1091 mm



-
-
-
-
-
-
-
-
-
-
-
-

V6643

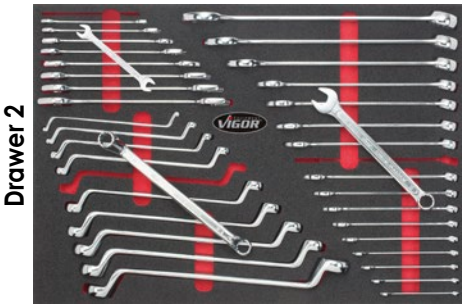

Drawer 2

V4230



Drawer 3

V4188

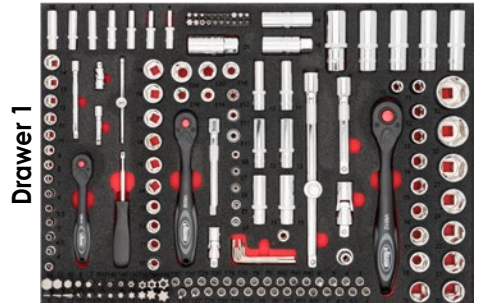

Drawer 1

V5636



Drawer 4

Mobile work bench with assortment

EQUIPMENT
VIGOR

V5158, EAN 4047728051583

Work bench VIGOR 1000

Mobile work bench with assortment



RAL 9005 7004
 Assortment contents: Product video:
375 V1000 3/3+
 115 kg 1000 kg
 8x 40 kg
 7x 569x397x75 mm 1x 569x397x154 mm
 Dimensions: 1210 mm (width), 1000 mm (height), 1091 mm (depth), 520 mm (top thickness), 181 mm (wheel offset)

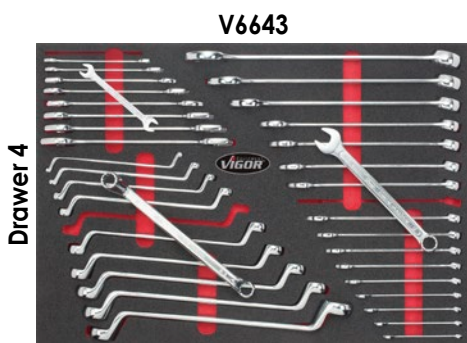
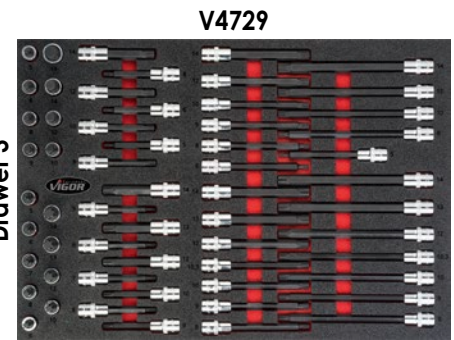
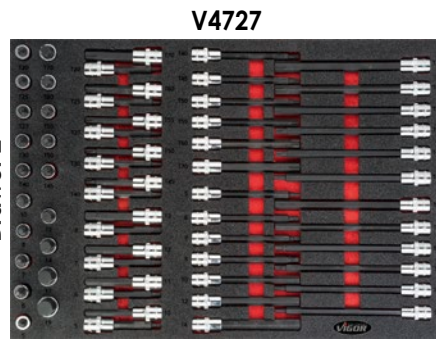

V4638, EAN 4047728**046381**

Safety platform, aluminium

- Lightweight
- Safety locking on both feet
- Maximum loading capacity: 150 kg
- Weight: 7.2 kg

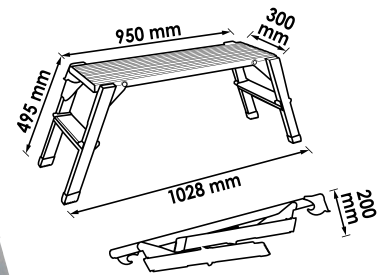

Space saving collapsible



V4758, EAN 4047728**047586**

Service trolley

- Robust sheet-steel design (thickness: sheets 1 mm, angle elements 1.5 mm)
- Middle level adjustable in height to make space for containers, for example
- Loading capacity per tray: 40 kg
- Height per shelf: 275 mm
- Large ball-bearing wheels (Ø 100 mm), 2 swivel castors, 2 fixed castors
- Easy manoeuvrability, even with high dynamic load
- Sturdy handle, firmly attached to the trolley's corpus
- Weight: 19 kg

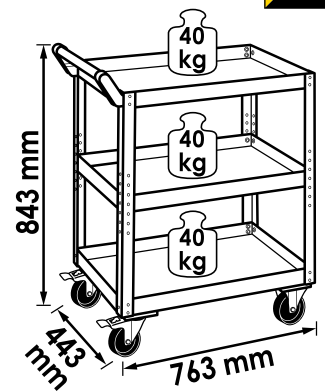

V5180, EAN 4047728**051804**

Swivel castor (pair)

- For V4758



V5191, EAN 4047728**051910**

Fixed castor (pair)

- For V4758





V5489, EAN 4047728054898

VIGOR 500N

Tool trolley without assortment



RAL Product video:



V1000
3/3+

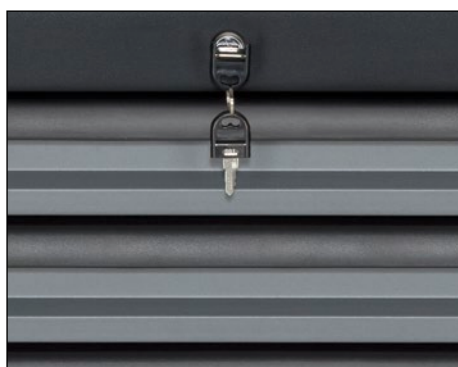
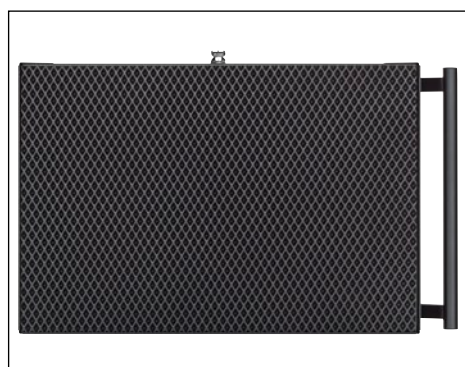
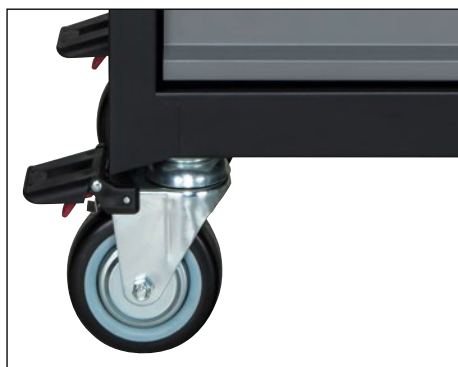
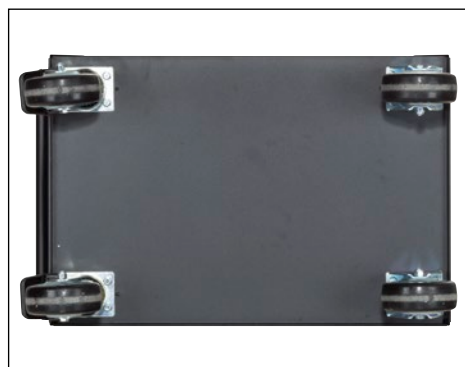
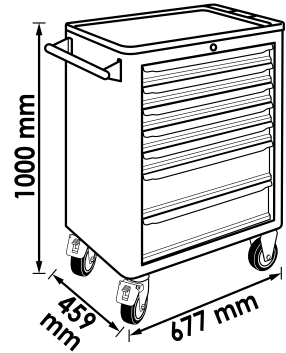
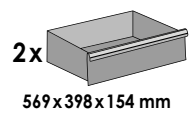
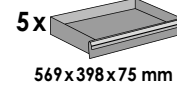
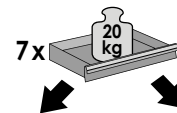

V1901, EAN 4047728019019

VIGOR 1000

Tool trolley without assortment

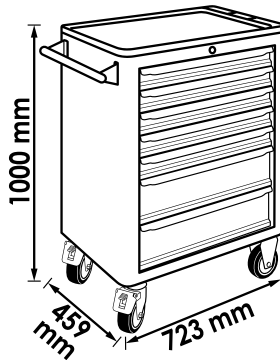

RAL 9005 7004

Product video: **V1000 3/3+**

72 kg 500 kg

7x 25 kg

5x 569x398x75 mm 2x 569x398x154 mm



V1902, EAN 4047728019026

VIGOR 1000

Tool chest for tool trolley V1901 / Lower cabinet for work bench V2531, without assortment

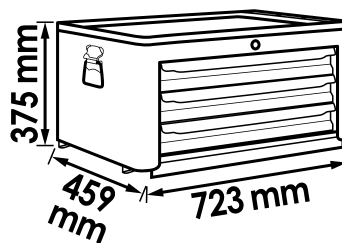

RAL 9005 7004

Product video: **V1000 3/3+**

29 kg

3x 25 kg 569x398x75 mm

- Delivery without plastic worktop, see V1909 -



Tool trolleys without assortment



V1970, EAN 4047728019705

VIGOR 1000

Tool trolley with tool chest, without assortment



RAL 9005 7004

Product video:  **V1000 3/3+**

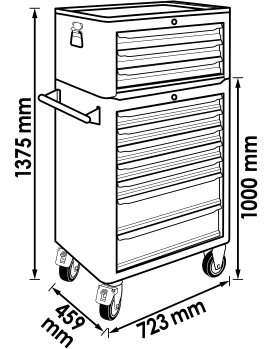
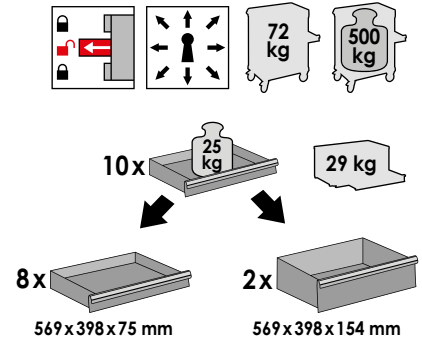

V4481, EAN 4047728044813

VIGOR 1000 XL

Tool trolley without assortment, with plastic worktop

RAL



Product video:



V1000
4/3+

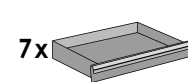
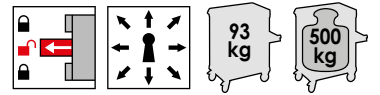

753x398x75 mm

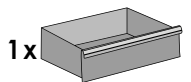

753x398x154 mm

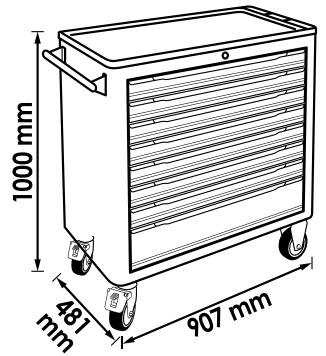

Tool trolleys without assortment



V4481-X, EAN 4047728060721

VIGOR 1000 XL

Tool trolley without assortment, with stainless steel worktop

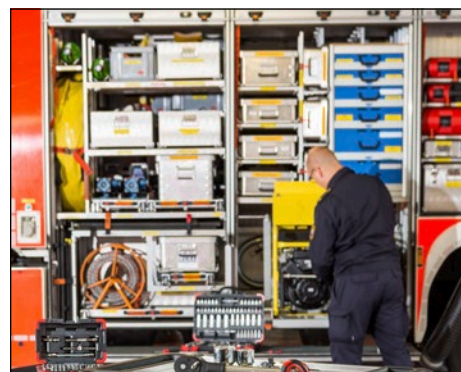
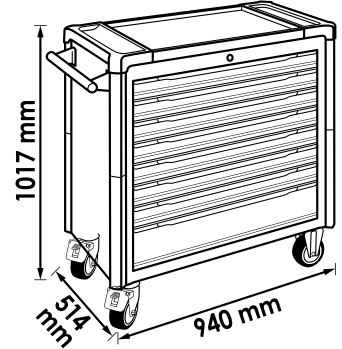
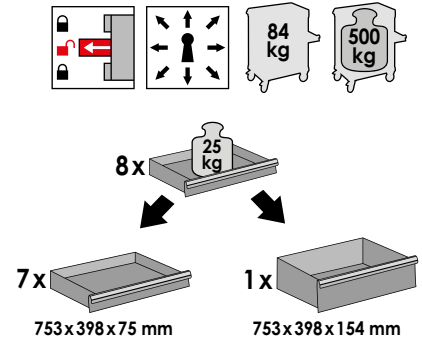
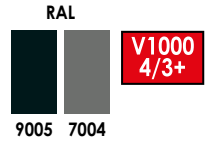

V4481-XD, EAN 4047728066488

VIGOR 1000 XD

Extra-deep tool trolley without assortment, with stainless steel worktop



NEW

RAL	
9005	7004

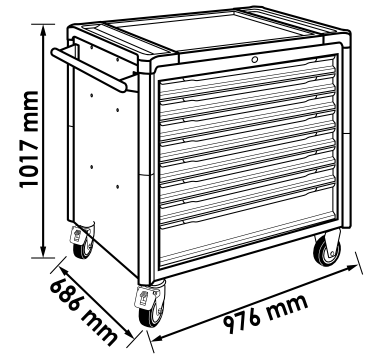
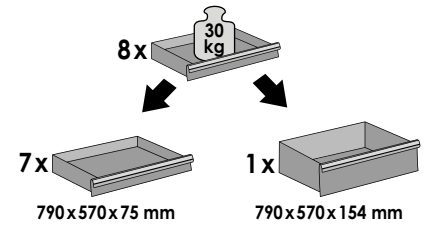
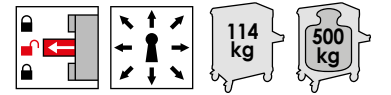

*How deep is your love?
Stainless steel worktop with practical
small parts storage compartment*



V4481 - EXTRA DEEP

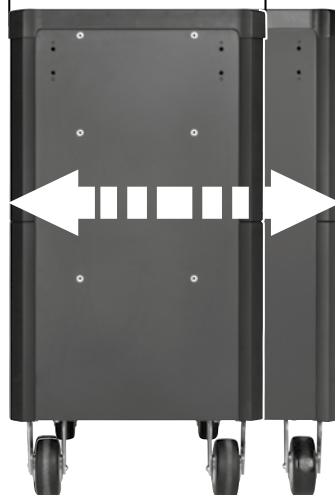
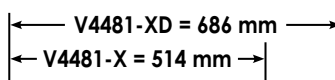

Tool trolleys without assortment



V4814, EAN 4047728048149

VIGOR 1000 XL Special

Mobile work bench without assortment



RAL  

Product video: 

V1000
4/3+

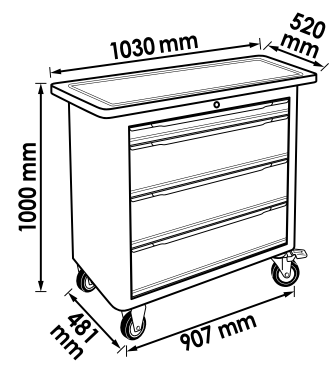
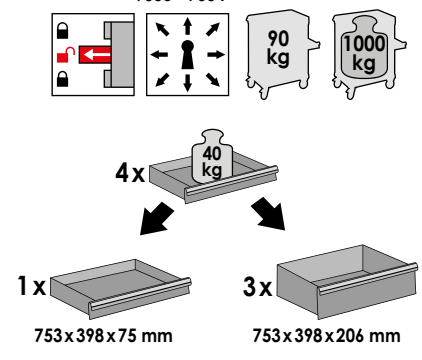

V4813, EAN 4047728048132

Work bench VIGOR 1000

Mobile work bench without assortment

RAL 9005 7004

Product video:

V1000 3/3+

8x 40 kg

115 kg

7x 569 x 397 x 75 mm

1x 569 x 397 x 154 mm

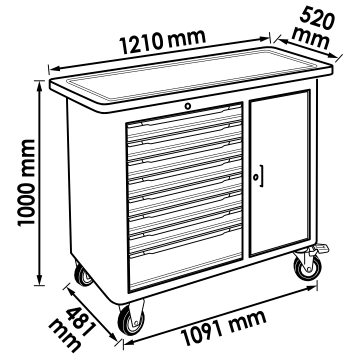

V6221, EAN 4047728062213

Laptop table

- Additional storage space for laptops, tablets, tools or motor vehicle components
- Suitable for all series
- Can be expanded and collapsed when installed
- Expansion of the tool trolley surface for better organisation and overview while working
- Locking element prevents unintentional folding of the table
- Maximum permitted loading capacity: 25 kg

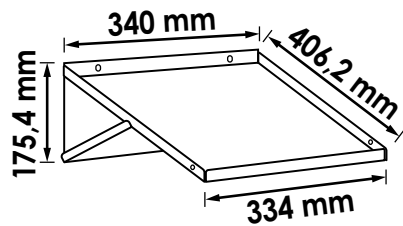

V6395, EAN 4047728070522

Waste bin

- Disposal of waste or cloths
- Suitable for all series
- Also suitable for storing tools
- Capacity: 20 l

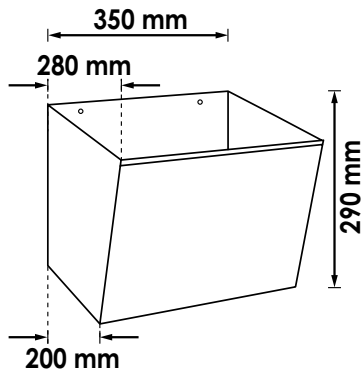

NEW

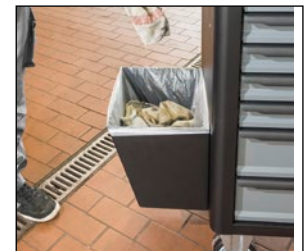

V6396, EAN 4047728069601

Screwdriver holder

- Quick access to screwdriver directly on the tool trolley
- Suitable for all series
- For 12 screwdrivers

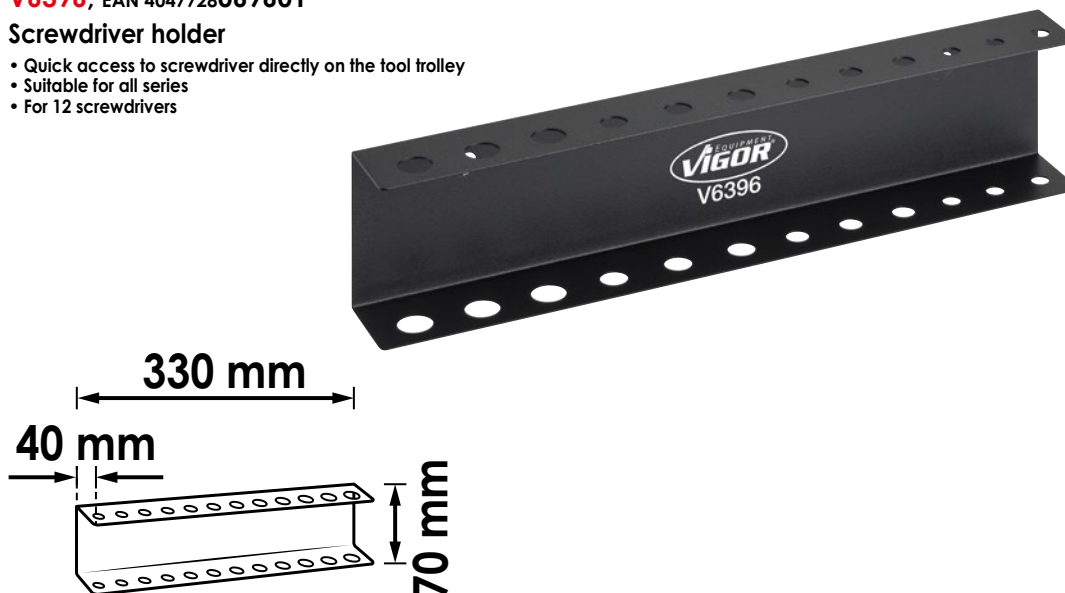

NEW



V2397, EAN 4047728023979

Holder for paper reel

- Paper reels can be hung directly at the workplace
- Suitable for all series
- Paper reel not included
- Maximum width of paper reel: 370 mm

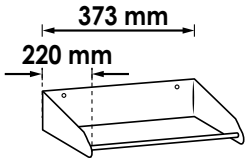

V6397, EAN 4047728069793

Holder for paper reel, pivotable

- Paper reels can be hung directly at the workplace
- Suitable for all series
- Paper reel not included
- Maximum width of paper reel: 320 mm

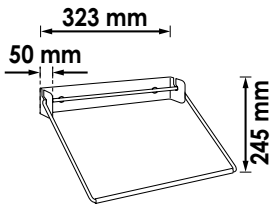

V6393-S, EAN 4047728069205

Document holder, small

- Storing of clipboards or order pockets directly at the workstation
- Suitable for all series
- Optimum storage of documents or workshop documents directly at the workplace
- Small design

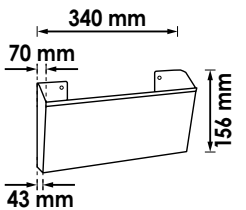

V6393, EAN 4047728069519

Document holder, large

- Storing of clipboards or order pockets directly at the workstation
- Suitable for all series
- Optimum storage of documents or workshop documents directly at the workplace
- Large design

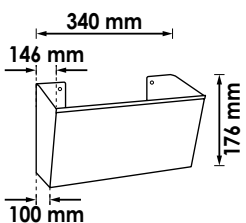

V2393, EAN 4047728023931

Can holder, standard

- For tool trolleys VIGOR 500 N · 1000 · 1000 XL and 1000 XD (except V4481-X)
- Storage for up to 5 cans

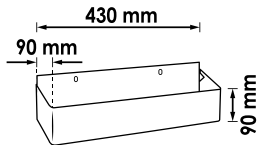

V2393-S, EAN 4047728062046

Can holder, short

- Suitable for all series
- Storage for up to 4 cans
- Including compartment system

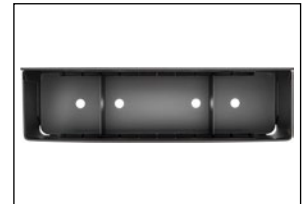
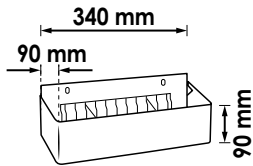

V2393-XD, EAN 4047728067614

Can holder, extra long

- For VIGOR 1000 XD (V4481-XD)
- Storage for up to 6 cans
- Including compartment system

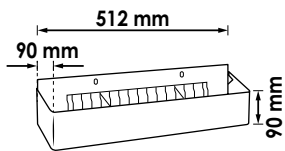

V4893, EAN 4047728048934

Pull-handle

- Easy manoeuvring of tool trolleys and work benches
- For tool trolleys VIGOR 1000 and 1000 XL

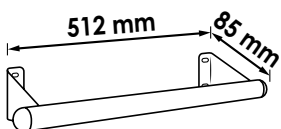

VIGOR Separation sheets



NEW

Hot-dip galvanized surface prevents rust formation

Asymmetrical punching allows the separation sheets to be placed side-by-side within a row

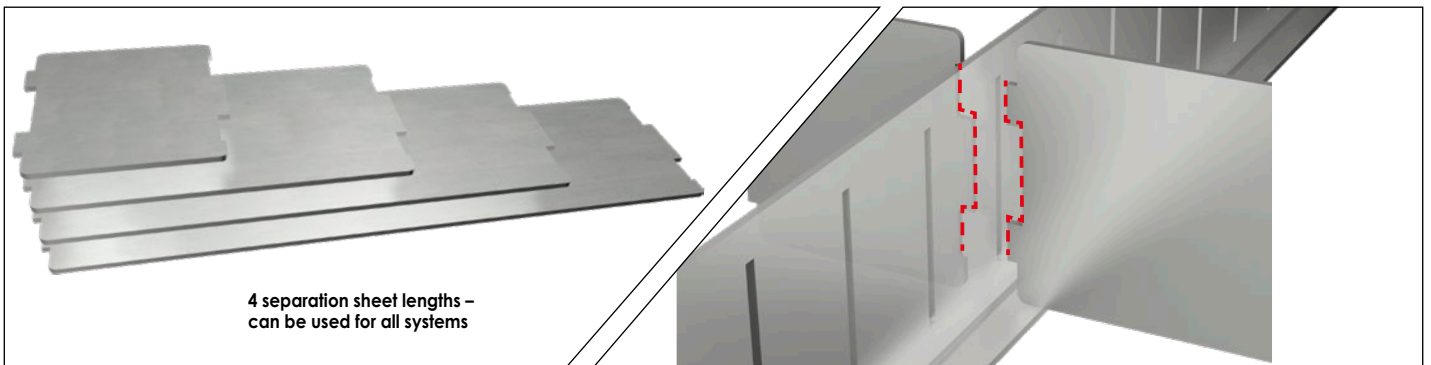

4 separation sheet lengths – can be used for all systems



More stability and hold thanks to splayed edges

Clever – Three Sizes, One System!

V6688, EAN 4047728070249

Separation sheet set VIGOR 500 N and VIGOR 1000

- Sorting small parts in tool trolley or storage system lower cabinets
- All four separation sheet sizes compatible with the separation sheet set
- Separation sheets can be inserted into each other thanks to asymmetrical punching
- Hot-dip galvanized surface prevents rust formation
- 13 bars for individually splitting up the cross members
- 15 subdivided fields possible within a gap
- Suitable for the VIGOR 500 N and VIGOR 1000 series
- 192 partitions possible

①

192 partitions possible!

V1000 3/3+

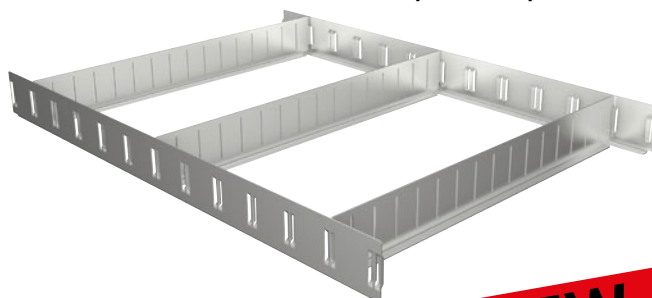

NEW



V6688-XL, EAN 4047728070096

VIGOR 1000 XL separation sheet set

- Sorting small parts in tool trolley or storage system lower cabinets
- All four separation sheet sizes compatible with the separation sheet set
- Separation sheets can be inserted into each other thanks to asymmetrical punching
- Hot-dip galvanized surface prevents rust formation
- 17 bars for individually splitting up the cross members
- 15 subdivided fields possible within a gap
- Suitable for the VIGOR 1000 XL series
- 256 partitions possible

NEW

②

256 partitions possible!

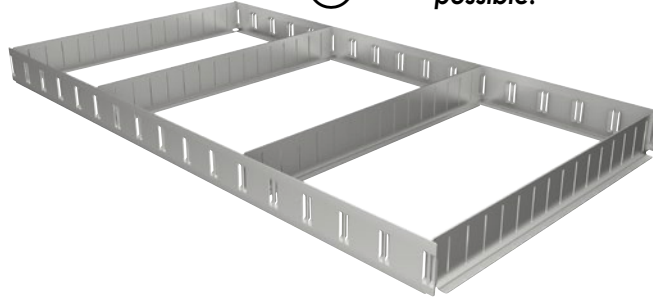

V1000
4/3+



V6688-XD, EAN 4047728070089

VIGOR 1000 XD separation sheet set

- Sorting small parts in tool trolley or storage system lower cabinets
- All four separation sheet sizes compatible with the separation sheet set
- Separation sheets can be inserted into each other thanks to asymmetrical punching
- Hot-dip galvanized surface prevents rust formation
- 17 bars for individually splitting up the cross members
- 22 subdivided fields possible within a gap
- Suitable for the VIGOR 1000 XD series
- 368 partitions possible

NEW

③

368 partitions possible!

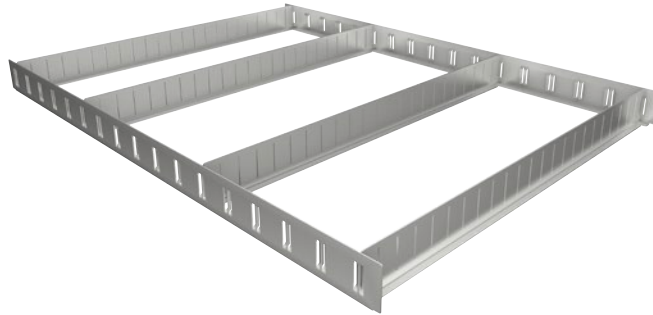

V1000 XD
6/3+
3/3+ V1000

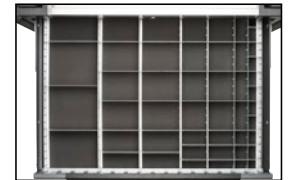

V6687/5, EAN 4047728070072

Cross member set for VIGOR 1000 XD

- Expansion of the separation sheet set V6688-XD for more partitions
- Hot-dip galvanized surface prevents rust formation



More stability and hold thanks to splayed edges

V6686/5, EAN 4047728070065

Cross member set for VIGOR 500 N, 1000 and 1000 XL

- Expansion of the separation sheet set V6688 and V6688-XL for more partitions
- Hot-dip galvanized surface prevents rust formation



V6685-1/20, EAN 4047728070133

Separation sheet set, small 45 mm

- Compatible with all separation sheet sets and cross members
- For partitioning within a column

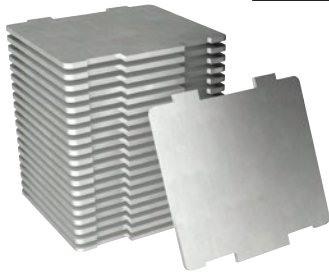

V6685-2/20, EAN 4047728070126

Separation sheet set, medium 91 mm

- Compatible with all separation sheet sets and cross members
- For partitioning within a column

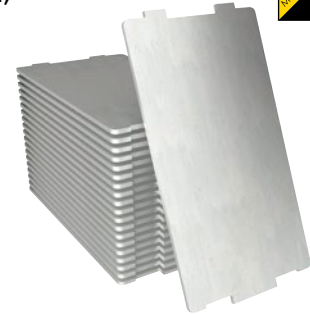

NEW

4 different separation sheet lengths – can be used for all systems

V6685-3/10, EAN 4047728070119

Separation sheet set, large 137 mm

- Compatible with all separation sheet sets and cross members
- For partitioning within a column

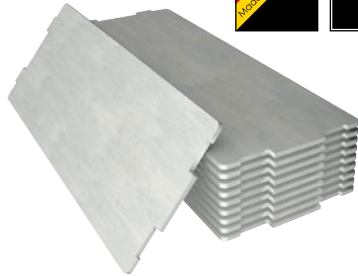

V6685-4/10, EAN 4047728070102

Separation sheet set, extra large 183 mm

- Compatible with all separation sheet sets and cross members
- For partitioning within a column



V2399, EAN 4047728023993

Separation sheet set

- For tool trolleys VIGOR 500 N · VIGOR 1000 only
- Pack of two panel partitions and three separation sheets

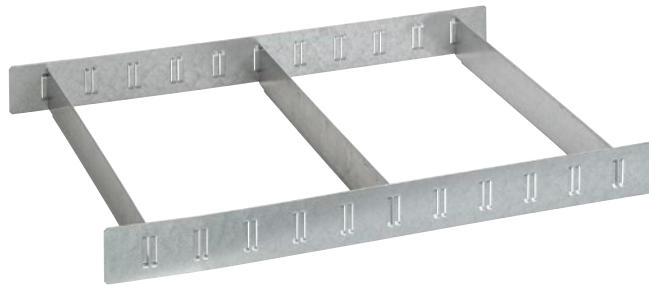

W 568xH 45 mmxD 394 mm

V4481-1, EAN 4047728045780

Separation sheet set V1000 XL

- Only for VIGOR 1000 XL
- Pack of two panel partitions and four separation sheets

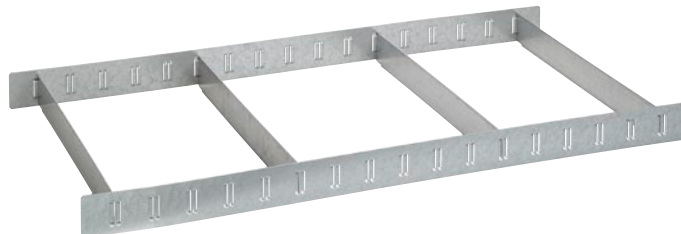

W 750xH 45xD 394 mm

V2398, EAN 4047728023986

Separation sheet set

- For tool trolleys VIGOR 500 N · VIGOR 1000 · VIGOR 1000 XL
- Five pieces per pack
- Only to be used together with the separation sheet assortment V2399

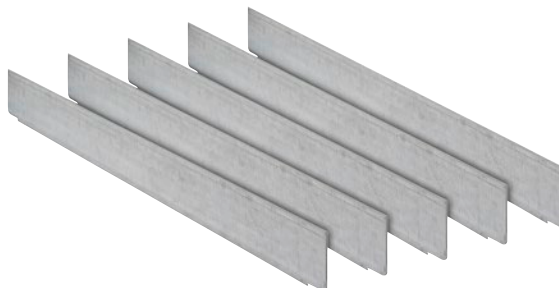

W 394xH 45 mm

V1907, EAN 4047728**019071**

Fixed castor

- For tool trolleys VIGOR 500 N · VIGOR 1000 and VIGOR 1000 XL



V1908, EAN 4047728**019088**

Swivel castor

- For tool trolleys VIGOR 500 N · VIGOR 1000 and VIGOR 1000 XL



V4814-3, EAN 4047728**053044**

Fixed castor (pair)

- For tool trolleys VIGOR 1000 XL · 1000 XL Special and work benches



V4814-2, EAN 4047728**053037**

Swivel castor (pair)

- For tool trolleys VIGOR 1000 XL · 1000 XL Special and work benches



V5489-4, EAN 4047728055413

Drawer, flat

- For tool trolley VIGOR 500 N
- Length: 569 mm; width: 398 mm; height: 75 mm

V1000
3/3+

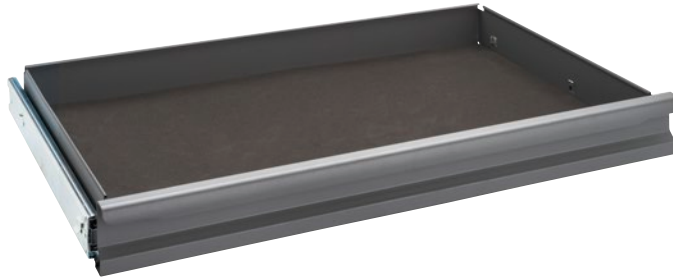

V5489-3, EAN 4047728055307

Drawer, high

- For tool trolley VIGOR 500 N
- Length: 569 mm; width: 398 mm; height: 154 mm

V1000
3/3+



V1905, EAN 4047728019057

Drawer, flat

- For tool trolleys VIGOR 1000 · V1901 · V1902 and work bench V4813
- Length: 569 mm; width: 398 mm; height: 75 mm

V1000
3/3+



V1906, EAN 4047728019064

Drawer, high

- For tool trolleys VIGOR 1000 · V1901 and work bench V4813
- Length: 569 mm; width: 398 mm; height: 154 mm

V1000
3/3+



Accessories for tool trolleys



V4112, EAN 4047728**041126**

Drawer, flat

- For tool trolleys VIGOR 1000 XL and VIGOR 1000 XL Special
- Length: 753 mm; width: 398 mm; height: 75 mm



V1000
4/3+



V4111, EAN 4047728**041119**

Drawer, high

- For tool trolley VIGOR 1000 XL
- Length: 753 mm; width: 398 mm; height: 154 mm



V1000
4/3+



V4814-1, EAN 4047728**053020**

Drawer, high

- For tool trolley VIGOR 1000 XL Special
- Length: 741 mm; width: 397 mm; height: 206 mm



V1000
4/3+



V6000-020, EAN 4047728**069588**

Spare lock for VIGOR Storage System

- Including 2 keys
- For all VIGOR hinged door cabinets: V6000-030 · V6000-030XL · V6000-02 · V6000-02XL · V6000-03 · V6000-03XL · V6000-011



NEW



V2462, EAN 4047728**024624**

Spare lock for VIGOR tool trolley

- Including 2 keys
- For all VIGOR tool trolleys and work benches



V1904, EAN 4047728**019040**

Locking system

• For all VIGOR tool trolleys and work benches



V1903, EAN 4047728**019033**

Guiding rails (pair)

• For tool trolleys VIGOR 1000 and VIGOR 1000 XL



V5489-1, EAN 4047728**055284**

Guiding rails (pair)

• For tool trolley VIGOR 500 N



V1909, EAN 4047728**019095**

Worktop, plastic

• For tool trolley and tool chest VIGOR 1000
• LxW: 723x459 mm



Accessories for tool trolleys



V4122, EAN 4047728**041225**

Worktop, plastic

- For tool trolley VIGOR 1000 XL
- LxW: 907x481 mm



V4813-1, EAN 4047728**053013**

Worktop, wood

- For mobile work bench VIGOR 1000
- LxW: 1030x520 mm



V4814-4, EAN 4047728**053051**

Worktop, wood

- For tool trolley VIGOR 1000 XL Special
- LxW: 1201x520 mm



V4813-2, EAN 4047728**059268**

Storage shelf

- For work bench VIGOR V4813
- LxW: 400x450 mm



V5489-2, EAN 4047728**055291**

Foam mat

- For tool trolley VIGOR 500 N
- LxW: 670x450 mm

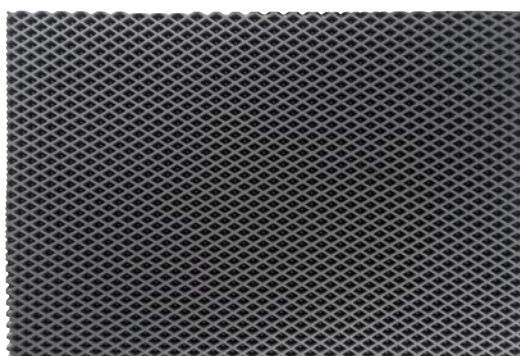

V2604, EAN 4047728026048

Work bench system

Work bench with tool cabinet and under-bench cabinet

- Setting up a workplace with large work surface and storage space
- The work bench system is extendable with tool hooks for the tool chest
- The under-bench cabinet can be equipped with VIGOR 3/3+ soft foam inserts
- Installation of the VIGOR machinist's vice is also possible
- Supplied without pictured tools and accessories (available on request)



V2532, EAN 4047728025324

Tool cabinet for work bench

- Extension of work bench V2531
- 2 roller blinds, lockable
- Without device for wall attachment
- Robust sheet-steel design with 1.0 mm sheet thickness
- Supplied without pictured tools and accessories (available on request)

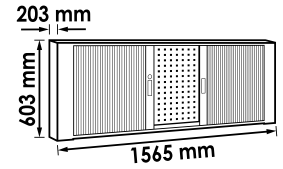

V2531, EAN 4047728025317

Work bench

- Highly stable thanks to robust steel design
- Maximum loading capacity 1000 kg
- Height adjustable feet 50 mm (rotary disc)
- 10 mm plastic worktop

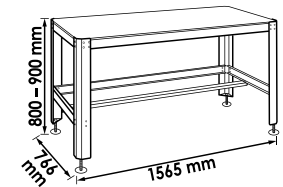

V2463, EAN 4047728024631

Holding plate for under-bench cabinet

- Fitting the under-bench cabinet V1902 to the work bench V2531



Tool hook set

- Hanging of tools
- Use with tool cabinet V2532 and perforated tool panel plates V6000-05 · V6000-015

VIGOR No. V2517	25	EAN 4047728+ 025171		VIGOR No. V2518	100	EAN 4047728+ 025188		VIGOR No. V2519	25	EAN 4047728+ 025195		VIGOR No. V2520	100	EAN 4047728+ 025201	



V6150, EAN 4047728**060691**

Vice

- Rotary disc
- Powder coated
- Jaw length 150 mm (6 inch)
- Thread depth 68 mm
- Clamping force 2.5 tonnes
- \pm 13.5 kg

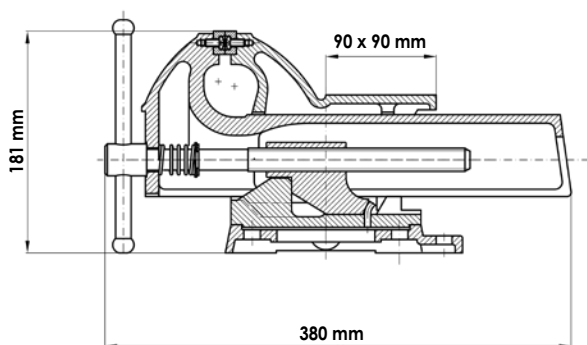
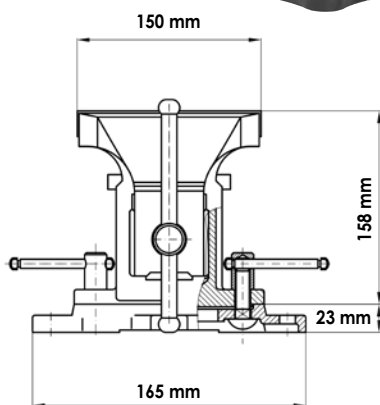
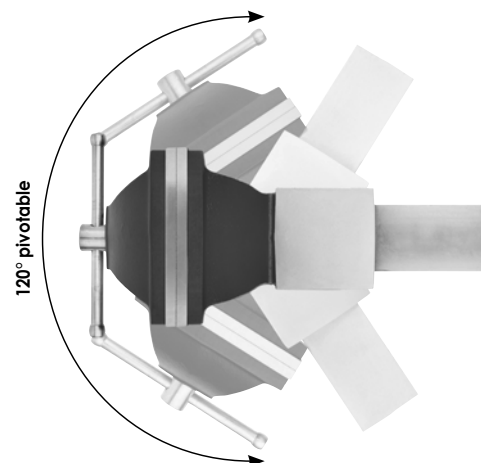
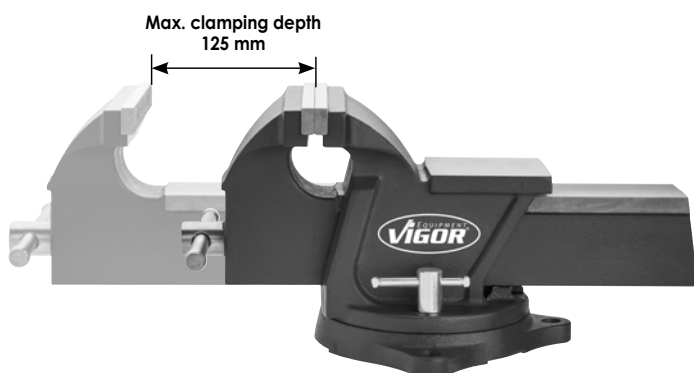



VSS example combinations



VIGOR 1000

VIGOR 1000 XL

**VIGOR 1000 +
VIGOR 1000 XL**

<p>1</p> <p>V1000 3/3+</p>	<p>2</p> <p>V1000 4/3+</p>	<p>3</p> <p>V1000 3/3+ V1000 4/3+ V1000 4/3+</p>
<p>4</p> <p>V1000 3/3+ V1000 3/3+</p>	<p>5</p> <p>V1000 4/3+ V1000 4/3+</p>	<p>6</p> <p>V1000 3/3+ V1000 4/3+</p>
<p>7</p> <p>V1000 3/3+ V1000 3/3+</p>	<p>8</p> <p>V1000 4/3+ V1000 4/3+</p>	<p>9</p> <p>V1000 4/3+ V1000 3/3+</p>
<p>10</p> <p>V1000 3/3+ V1000 3/3+ V1000 3/3+</p>	<p>11</p> <p>V1000 4/3+ V1000 4/3+ V1000 4/3+</p>	<p>12</p> <p>V1000 3/3+ V1000 4/3+ V1000 4/3+</p>



VIGOR 1000



VIGOR 1000 XL



1 Worktop for a lower cabinet: 676 mm

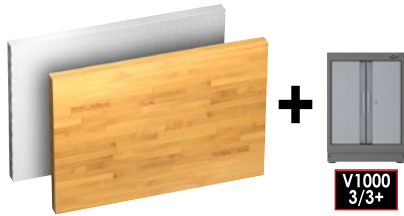

1 Worktop for a lower cabinet: 861 mm

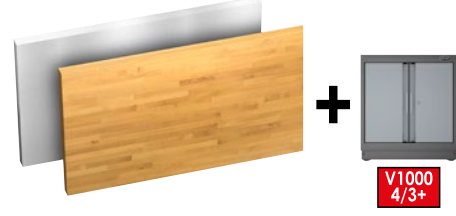

2 Worktop for two lower cabinets: 1357 mm

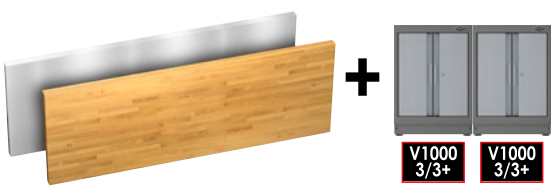

2 Worktop for two lower cabinets: 1725 mm

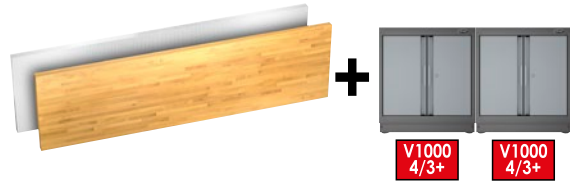

3 Worktop for three lower cabinets: 2036 mm



3 Worktop for three lower cabinets: 2588 mm



VIGOR 1000

Combined worktops

VIGOR 1000 XL

1 Worktop for two lower cabinets: 1541 mm

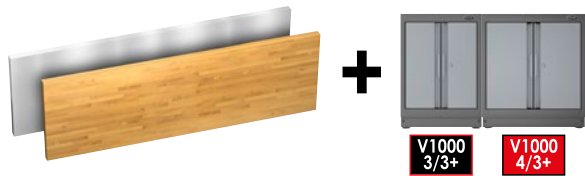

2 Worktop for three lower cabinets: 2215 mm

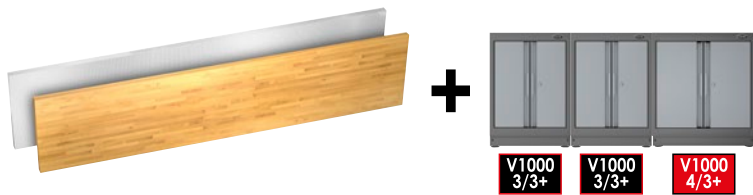

3 Worktop for three lower cabinets: 2404 mm

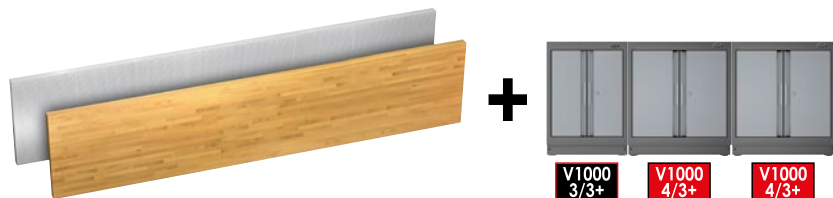

V6000-3, EAN 4047728048729

Wall unit

- For individually designing workshop equipment



- Cabinet door can be fitted on the right and left
- Cabinet door with magnetic lock
- Height-adjustable storage compartment
- All doors reinforced in the centre



- Simultaneous locking (equivalent to the VIGOR 1000 locking system)



- Drawer dimensions same as for VIGOR 1000 series (569 x 398 x 75 mm flat drawer, 569 x 398 x 154 mm high drawer)
- Design with wooden worktop





• Wall cabinets including high-quality shock absorbers

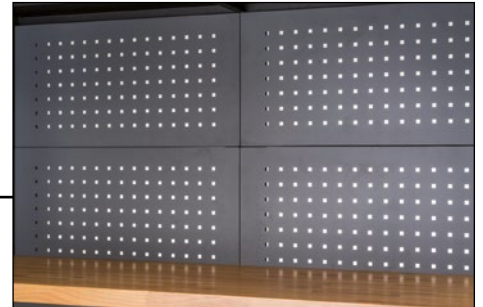

• Perforated tool panel suitable for VIGOR tool hook sets V2517, V2518, V2519 and V2520

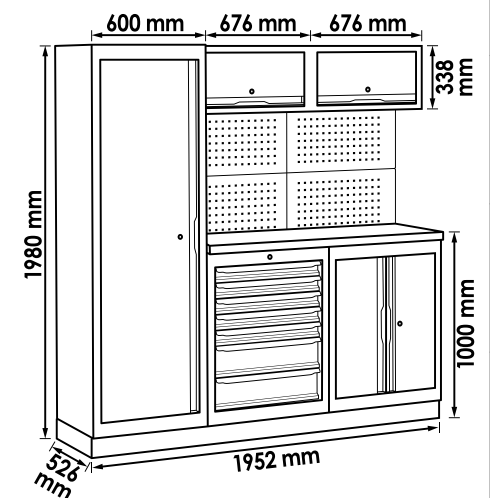

V6000-7, EAN 4047728055390

Wall unit

- For individually designing workshop equipment
- Storage system including corner element



- Wall cabinets including high-quality shock absorbers



- Cabinet door can be fitted on the right and left
- Cabinet door with magnetic lock
- Height-adjustable storage compartment
- All doors reinforced in the centre



- Simultaneous locking (equivalent to the VIGOR 1000 locking system)



- Drawer dimensions same as for VIGOR 1000 series (569 x 398 x 75 mm flat drawer, 569 x 398 x 154 mm high drawer)
- Design with wooden worktop

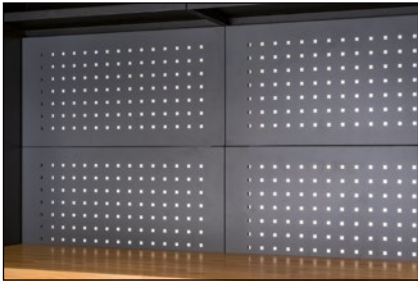

• Perforated tool panel suitable for VIGOR tool hook sets V2517, V2518, V2519 and V2520

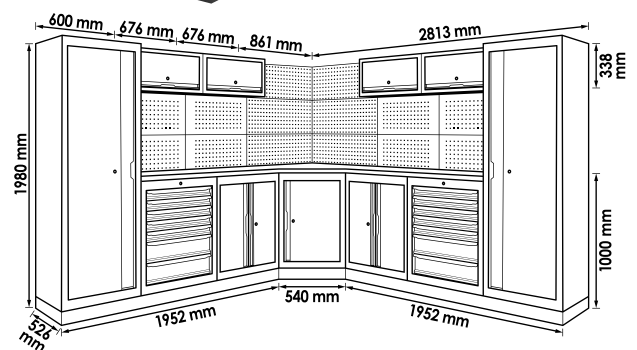
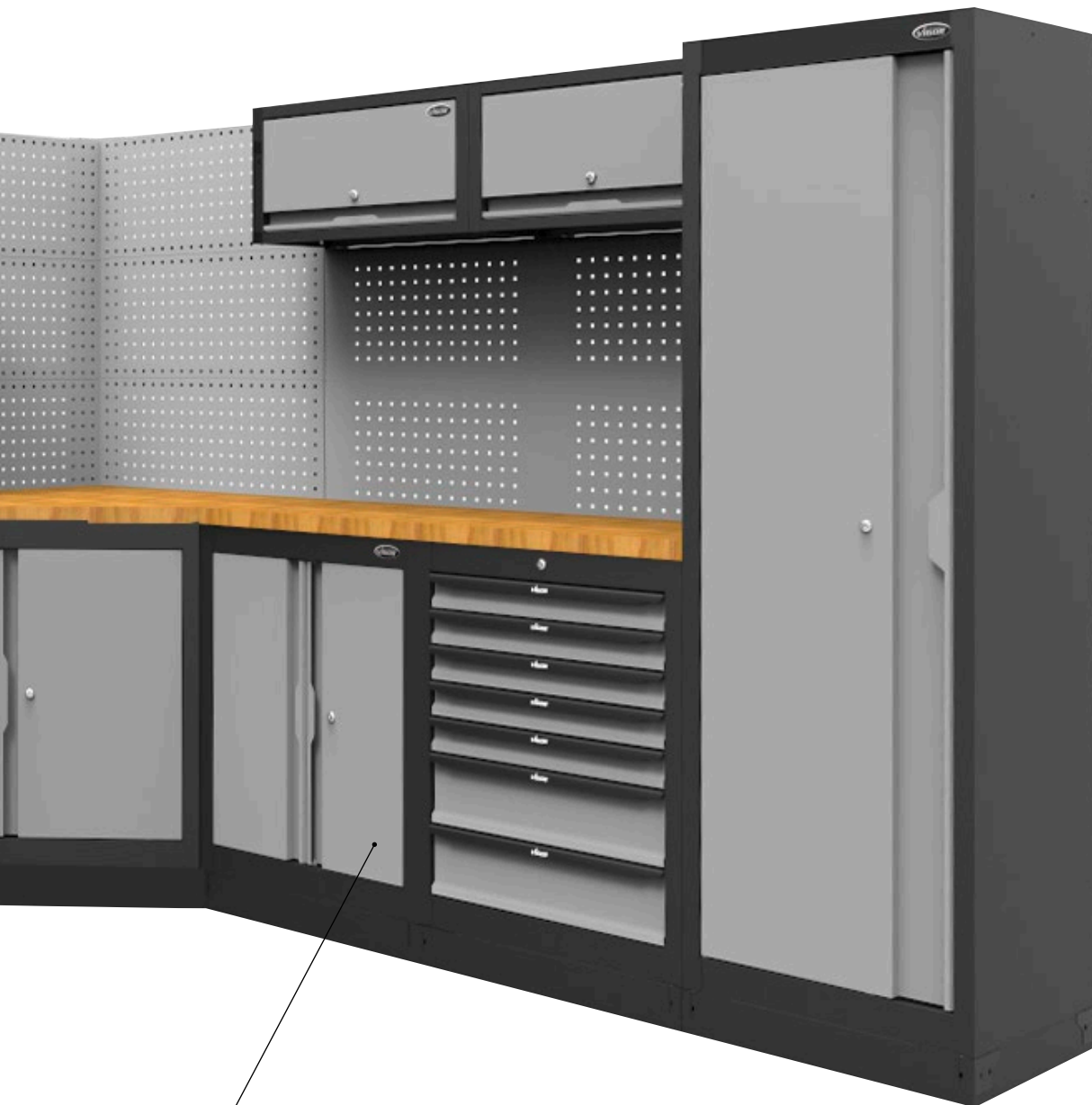



V6000-030, EAN 4047728**070140**

Drawer lower cabinet, 3 drawers

- Setting up a stationary workstation
- Clean storage of tools, small parts or various consumables
- To save space and for tidy organisation, we recommend VIGOR separation sheets or soft foam inserts
- Similar to the VIGOR 1000 series
- Dimensions (HxWxD)
1st - 3rd drawer: 75x569x398 mm



NEW

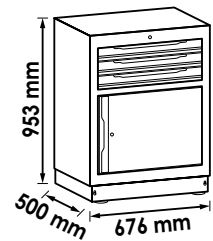

V1000
3/3+



V6000-030XL, EAN 4047728**070294**

Drawer lower cabinet, 3 drawers

- Setting up a stationary workstation
- Clean storage of tools, small parts or various consumables
- To save space and for tidy organisation, we recommend VIGOR separation sheets or soft foam inserts
- Similar to the VIGOR 1000 XL series
- Dimensions (HxWxD)
1st - 3rd drawer: 75x753x398 mm



NEW

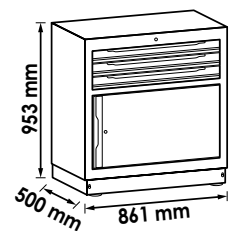

V1000
4/3+



V6000-031, EAN 4047728**070157**

Drawer lower cabinet, 5 drawers

- Setting up a stationary workstation
- Clean storage of tools, small parts or various consumables
- To save space and for tidy organisation, we recommend VIGOR separation sheets or soft foam inserts
- Similar to the VIGOR 1000 series
- Dimensions (HxWxD)
1st drawer: 75x569x398 mm
2nd – 5th drawer: 154x569x398 mm



NEW



V1000
3/3+

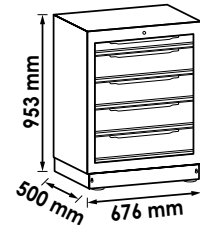

V6000-031XL, EAN 4047728**070300**

Drawer lower cabinet, 5 drawers

- Setting up a stationary workstation
- Clean storage of tools, small parts or various consumables
- To save space and for tidy organisation, we recommend VIGOR separation sheets or soft foam inserts
- Similar to the VIGOR 1000 XL series
- Dimensions (HxWxD)
1st drawer: 75x753x398 mm
2nd – 5th drawer: 154x753x398 mm



NEW



V1000
4/3+

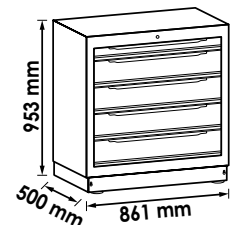

V6000-01, EAN 4047728**048248**

Drawer lower cabinet, 7 drawers

- Setting up a stationary workstation
- Clean storage of tools, small parts or various consumables
- To save space and for tidy organisation, we recommend VIGOR separation sheets or soft foam inserts
- Similar to the VIGOR 1000 series
- Dimensions (HxWxD)
1st - 5th drawer: 75x569x398 mm
6th – 7th drawer: 154x569x398 mm



NEW



V1000
3/3+

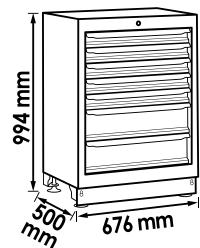

V6000-01XL, EAN 4047728070317

Drawer lower cabinet, 7 drawers

- Setting up a stationary workstation
- Clean storage of tools, small parts or various consumables
- To save space and for tidy organisation, we recommend VIGOR separation sheets or soft foam inserts
- Similar to the VIGOR 1000 XL series
- Dimensions (HxWxD)
1st - 5th drawer: 75x753x398 mm
6th - 7th drawer: 154x753x398 mm



NEW



V1000
4/3+

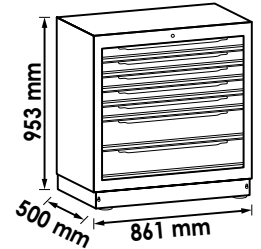

V6000-019, EAN 4047728063883

Tool trolley for storage system, 7 drawers

- Space-saving storage of a tool trolley under the wall unit worktop
- Especially for VIGOR storage system
- 4 swivel castors and special height for space-saving storage of the tool trolley after use under the storage system worktop
- Similar to the VIGOR 1000 series
- Dimensions (HxWxD)
1st - 5th drawer: 75x569x398 mm
6th - 7th drawer: 154x569x398 mm



NEW



V1000
3/3+

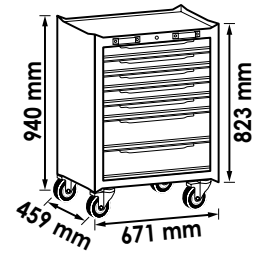

With 4 swivel castors



V6000-019XL, EAN 4047728070683

Tool trolley for storage system, 7 drawers

- Space-saving storage of a tool trolley under the wall unit worktop
- Especially for VIGOR storage system
- 4 swivel castors and special height for space-saving storage of the tool trolley after use under the storage system worktop
- Similar to the VIGOR 1000 XL series
- Dimensions (HxWxD)
1st - 5th drawer: 75x753x398 mm
6th - 7th drawer: 154x753x398 mm



NEW



V1000
4/3+

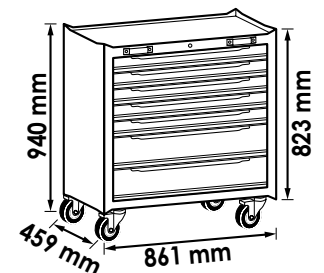

With 4 swivel castors



V6000-032, EAN 4047728070171

Drawer lower cabinet, 8 drawers

- Setting up a stationary workstation
- Clean storage of tools, small parts or various consumables
- To save space and for tidy organisation, we recommend VIGOR separation sheets or soft foam inserts
- Similar to the VIGOR 1000 series
- Dimensions (HxWxD)
1st – 7th drawer: 75 x 569 x 398 mm
8th drawer: 154 x 569 x 398 mm



NEW



V1000
3/3+

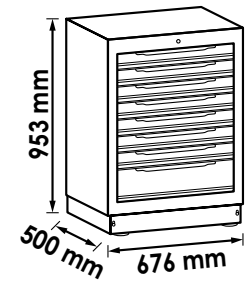

V6000-032XL, EAN 4047728070324

Drawer lower cabinet, 8 drawers

- Setting up a stationary workstation
- Clean storage of tools, small parts or various consumables
- To save space and for tidy organisation, we recommend VIGOR separation sheets or soft foam inserts
- Similar to the VIGOR 1000 XL series
- Dimensions (HxWxD)
1st – 7th drawer: 75 x 753 x 398 mm
8th drawer: 154 x 753 x 398 mm



NEW



V1000
4/3+

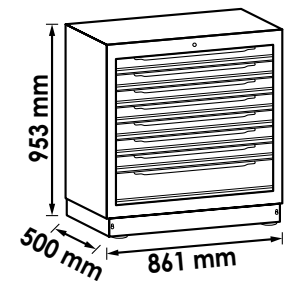

V6000-033, EAN 4047728070195

Lower cabinet for waste

- Setting up a stationary workstation
- Waste separation directly at the workstation
- Waste bin securely and neatly positioned in the storage system module
- Lower cabinet with flap for rapid waste disposal
- Delivery incl. two waste bins
- Capacity of the waste bin: 35 l
- Similar to the VIGOR 1000 series



NEW

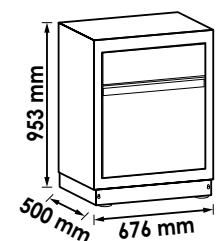

V6000-033XL, EAN 4047728070331

Lower cabinet for waste

- Setting up a stationary workstation
- Waste separation directly at the workstation
- Waste bin securely and neatly positioned in the storage system module
- Lower cabinet with flap for rapid waste disposal
- Delivery incl. three waste bins
- Capacity of the waste bin: 1x25 l · 2x35 l
- Similar to the VIGOR 1000 series



NEW

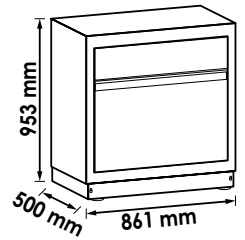

V6000-02XL, EAN 4047728070355

Lower cabinet with double-hinged door

- Setting up a stationary workstation
- Storage of tool boxes, work clothes, containers or motor vehicle parts
- Can be extended with additional V6000-018XL storage shelves
- Hinged-door with magnetic lock
- Height-adjustable storage compartment
- Inside dimensions (LxWxH): 561 x 466.4 x 561 mm
- Similar to the VIGOR 1000 XL series



NEW

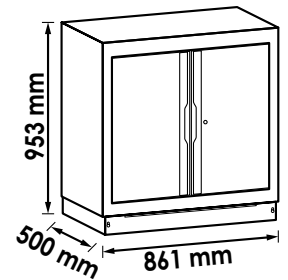

V6000-02, EAN 4047728048255

Lower cabinet with double-hinged door

- Setting up a stationary workstation
- Storage of tool boxes, work clothes, containers or motor vehicle parts
- Can be extended with additional V6000-018XL storage shelves
- Hinged-door with magnetic lock
- Height-adjustable storage compartment
- Inside dimensions (LxWxH): 561 x 466.4 x 561 mm
- Similar to the VIGOR 1000 series

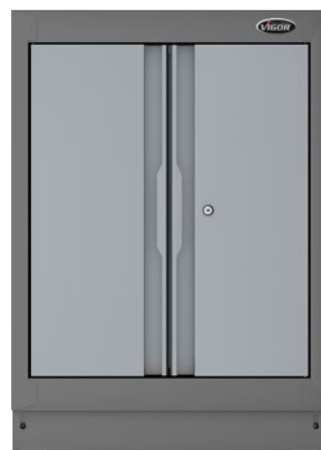

NEW

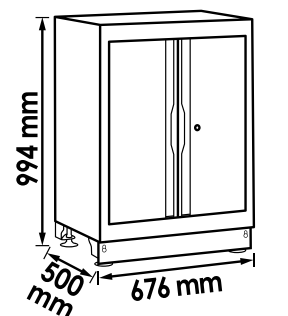

V6000-011, EAN 4047728**054904**

Corner base cabinet

- Corner extension for additional lower cabinet modules
- For VIGOR wall units V6000-3 and V6000-7
- Including height-adjustable storage shelf and solid wooden board



NEW

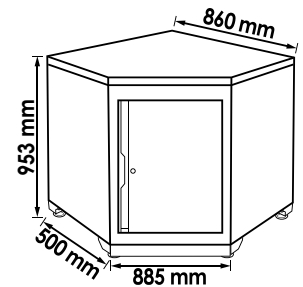

V6000-03, EAN 4047728**048262**

Cabinet with single-hinged door, high

- Storage of tool boxes, work clothes, containers or motor vehicle parts
- Cabinet door with magnetic lock
- Height-adjustable storage compartment
- Inside dimensions (L x W x H): 484 x 478 x 1503.3 / 220.5 mm
- Cabinet door can be fitted on the right and left
- Can be extended with V6000-017 storage shelves

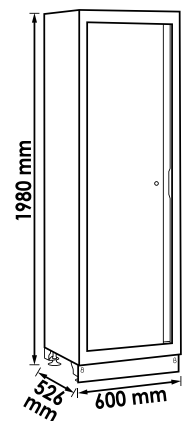

V6000-03XL, EAN 4047728070362

Cabinet with double-hinged door, high

- Storage of tool boxes, work clothes, containers or motor vehicle parts
- Cabinet door with magnetic lock
- Height-adjustable storage compartment
- Inside dimensions (LxWxH): 1119x510x1812 / 220.5 mm
- Cabinet door can be fitted on the right and left
- Can be extended with V6000-017XL storage shelves

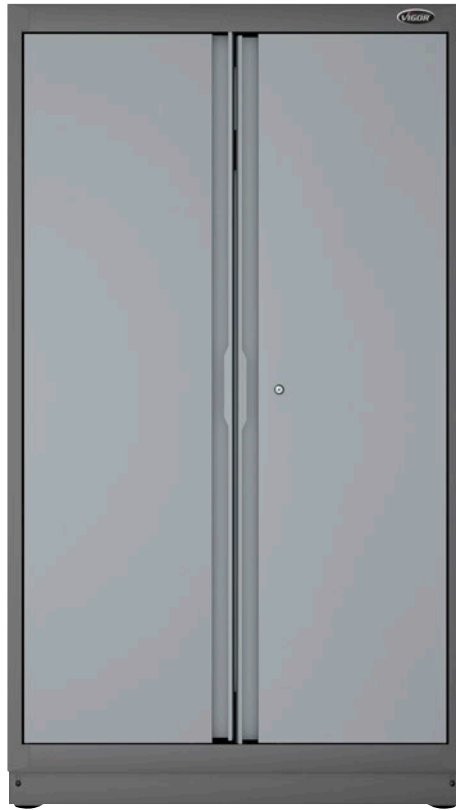

NEW

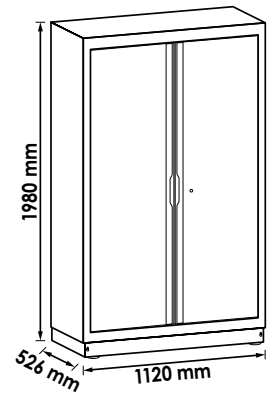

V6000-04XL, EAN 4047728070379

Wall cabinet

- Storage of tools, containers or motor vehicle parts



NEW

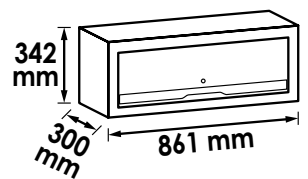

V6000-04, EAN 4047728048279

Wall cabinet

- Storage of tools, containers or motor vehicle parts

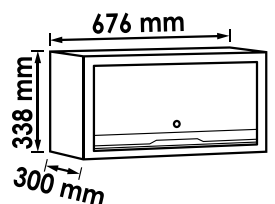

Worktop, wood



VIGOR No.	Designation	EAN 4047728+
V6000-013	Worktop, wood, small – width 676 mm	054928
V6000-022	Worktop, wood, small – width 861 mm	069823
V6000-08	Worktop, wood, medium – width 1357 mm	048415
V6000-023	Worktop, wood, medium – width 1725 mm	069854
V6000-021	Worktop, wood, large – width 2036 mm	069878
V6000-024	Worktop, wood, large – width 2588 mm	069892
V6000-025	Worktop, wood combined, medium – width 1541 mm	069915
V6000-026	Worktop, wood combined, large – width 2215 mm	069939
V6000-027	Worktop, wood combined, large – width 2404 mm	069953

Worktop, stainless steel

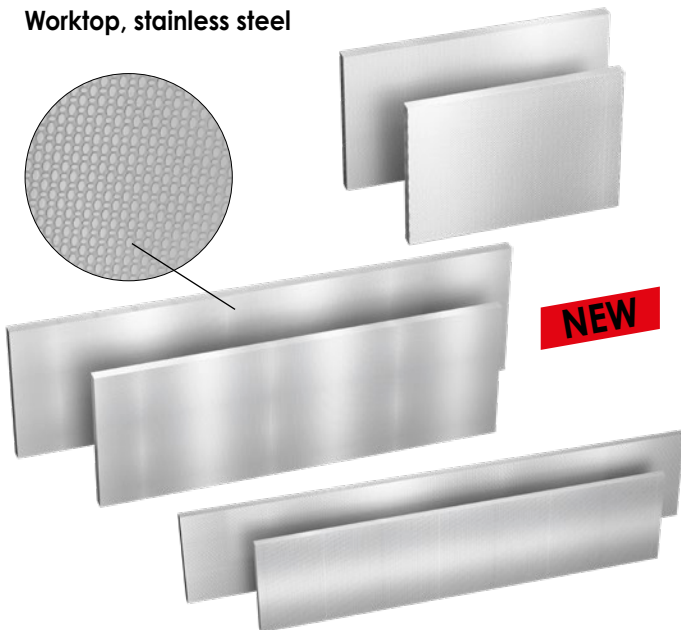

VIGOR No.	Designation	EAN 4047728+
V6000-013-X	Worktop, stainless steel, small – width 676 mm	069816
V6000-022-X	Worktop, stainless steel, small – width 861 mm	069830
V6000-08-X	Worktop, stainless steel, medium – width 1357 mm	069847
V6000-023-X	Worktop, stainless steel, medium – width 1725 mm	069861
V6000-021-X	Worktop, stainless steel, large – width 2036 mm	069885
V6000-024-X	Worktop, stainless steel, large – width 2588 mm	069908
V6000-025-X	Worktop, stainless steel combined, medium – width 1541 mm	069922
V6000-026-X	Worktop, stainless steel combined, large – width 2215 mm	069946
V6000-027-X	Worktop, stainless steel combined, large – width 2404 mm	069960

Worktops, five corners

• For corner lower cabinet



VIGOR No.	Designation	EAN 4047728+
V6000-012	Five-corner wooden worktop for combining two storage systems	054911
V6000-012-X	Five-corner stainless steel worktop for combining two storage systems	069977



V6000-05, EAN 4047728**048286**

Perforated tool plate, small

- Suitable for VIGOR 1000 wall unit modules
- Compatible with VIGOR tool hook sets

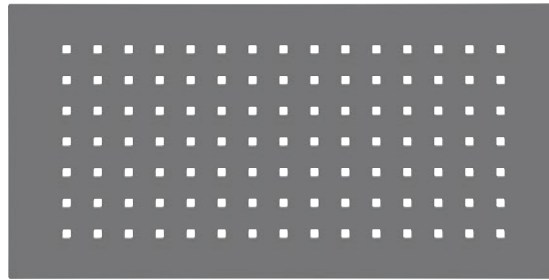

676 x 338 mm



V6000-015, EAN 4047728**055260**

Perforated tool panel, large

- Suitable for VIGOR 1000 XL wall unit modules
- Compatible with VIGOR tool hook sets

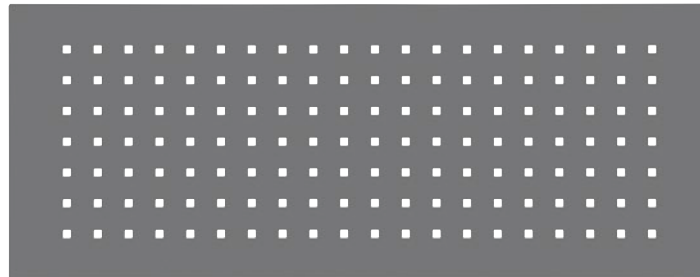

861 x 338 mm



Storage shelves

- Storage shelves for V6000-03 · V6000-03XL



VIGOR No.	EAN 4047728+	
V6000-017	055420	
NEW V6000-017XL	070669	

Storage shelf

- Storage shelf for V6000-02 · V6000-02XL



VIGOR No.	EAN 4047728+	
V6000-018	059275	
NEW V6000-018XL	070652	

V6000-06, EAN 4047728**048293**

Centre strut

- For VIGOR wall unit V6000-3
- Length: 2000 mm



V6000-07, EAN 4047728048309

Lateral strut set

- For VIGOR wall unit V6000-3
- Length: 2000 mm



V6000-010, EAN 4047728048439

Sidebar for under-bench cabinet

- For VIGOR wall unit V6000-3
- Length: 500 mm



V6000-09, EAN 4047728048422

Sidebar

- For VIGOR wall unit V6000-3
- Length: 526 mm



V6000-040/4, EAN 4047728070645

Set of connection plates

- Rear connection of two lower cabinets
- Contents: 4 connection plates incl. screws and nuts



NEW



V6000-041/4, EAN 4047728070676

Storage shelf bracket set

- For securing storage shelves



NEW





Tool storage

Multiboxes

94-97

Soft foam inserts

98-129



V5162, EAN 4047728051620

Multibox-L, with socket insert

- Click system enables connection and disconnection with associated boxes and mechanic's creeper
- Multibox V4700-L

X			Design	Size mm
1 x	-	-		-
13 x	6.3 1/4			4 · 4.5 · 5 · 5.5 · 6 · 7 · 8 · 9 · 10 · 11 · 12 · 13 · 14
6 x	6.3 1/4			3 · 4 · 5 · 6 · 7 · 8
3 x	6.3 1/4			PH1 · PH2 · PH3
3 x	6.3 1/4			PZ1 · PZ2 · PZ3
3 x	6.3 1/4			0.8x4 · 1x5.5 · 1.2x7
6 x	6.3 1/4			T10 · T15 · T20 · T25 · T30 · T40
1 x	-	6.3 1/4		150 mm
1 x	6.3 1/4	6.3 1/4		110 mm
1 x	6.3 1/4	6.3 1/4		40 mm
1 x	6.3 1/4	6.3 1/4		145 mm
1 x	6.3 1/4	6.3 1/4		50 mm
1 x	6.3 1/4	6.3 1/4		100 mm
18 x	12.5 1/2			10 · 11 · 12 · 13 · 14 · 15 · 16 · 17 · 18 · 19 · 20 · 21 · 22 · 23 · 24 · 27 · 30 · 32
2 x	12.5 1/2			16 · 21
1 x	-	12.5 1/2		250 mm
1 x	12.5 1/2	12.5 1/2		75 mm
1 x	12.5 1/2	12.5 1/2		125 mm
1 x	12.5 1/2	12.5 1/2		250 mm
4 x	-			1.27 · 1.5 · 2 · 2.5
1 x	-	6.3 1/4		150 mm
1 x	-	10 9/8		198 mm



1/2 + 71

6.3 1/4 12.5 1/2

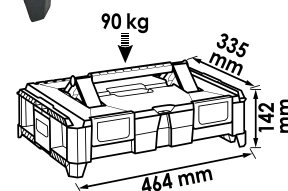

90 kg
Internal dimensions: 80 mm / 300 mm / 400 mm



V5164, EAN 4047728051644

Multibox-L, with screwdriver insert

- Click system enables connection and disconnection with associated boxes and mechanic's creeper
- Multibox V4700-L

X		Design	Size mm
1 x	-		-
1 x			T10 - T50
1 x			3x0.5
1 x			1.5 - 10
5 x			0.6x3 · 0.8x4 · 1.0x5.5 · 1.6x8 · 1.6x10
4 x			156 mm · 186 mm · 206 mm · 266 mm
1 x			1x5.5
1 x			97 mm



1/2 + 31

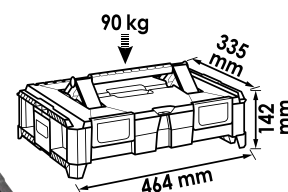

90 kg
Internal dimensions: 80 mm / 300 mm / 400 mm



V5167, EAN 4047728051675

Multibox-L, with hammer and chisel insert

- Click system enables connection and disconnection with associated boxes and mechanic's creeper
- Multibox V4700-L

1/2 +

14

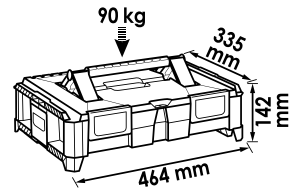

Internal dimensions: 400 mm x 300 mm x 80 mm



X	Design	Size mm
1 x		-
1 x		150 mm
1 x		175 mm
1 x		150 mm
1 x		120 mm
6 x		150 mm
1 x		280 mm
1 x		230 mm
1 x		350 mm
1 x		280 mm

V5165, EAN 4047728051651

Multibox-L, with VDE insert

- Click system enables connection and disconnection with associated boxes and mechanic's creeper
- Multibox V4700-L

1/2 +

13

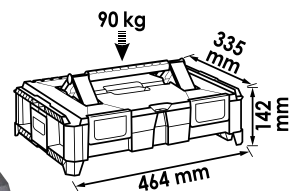

Internal dimensions: 400 mm x 300 mm x 80 mm



X	Design	Size mm
1 x		-
1 x		3x0.5
1 x		160 mm
1 x		160 mm
1 x		180 mm
1 x		200 mm
1 x		160 mm
4 x		0.5x3 · 0.8x4 · 1x5.5 · 1.2x6.5
3 x		141 mm · 161 mm · 206 mm



1000 V



V4700-L, EAN 4047728**046794**

Multibox L

- Click system enables connection and disconnection with associated boxes and mechanic's creeper
- Lightweight plastic box
- Maximum loading capacity: 90 kg

1/2 +

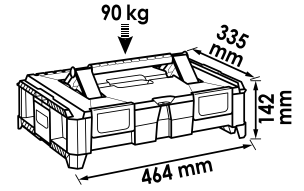

Click system enables quick connection and disconnection of the multiboxes
 Suitable for 1/2+ soft foam inserts



V4700-XL, EAN 4047728**049269**

Multibox XL

- Click system enables connection and disconnection with associated boxes and mechanic's creeper
- Lightweight plastic box
- Maximum loading capacity: 90 kg

1/2 +

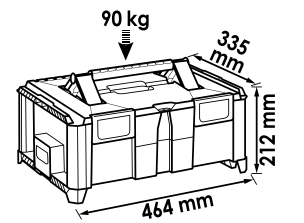

V4700-XXL, EAN 4047728**049276**

Multibox XXL

- Click system enables connection and disconnection with associated boxes and mechanic's creeper
- Lightweight plastic box
- Maximum loading capacity: 90 kg

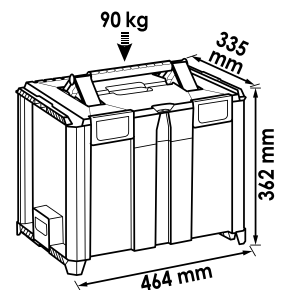

Internal dimensions:
312 mm x 300 mm x 400 mm



V4700-R, EAN 4047728**049283**

Mechanic's creeper for multibox

- Click system enables connection and disconnection with associated boxes and mechanic's creeper
- Mechanic's creeper for V4700-L · V4700-XL and V4700-XXL
- Maximum loading capacity: 200 kg



1/2 +



VIGOR 1000 Insert system



1/3+



1/2+

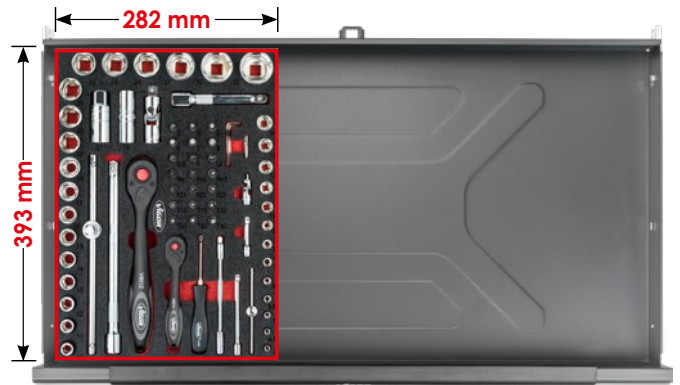

V1000
3/3+

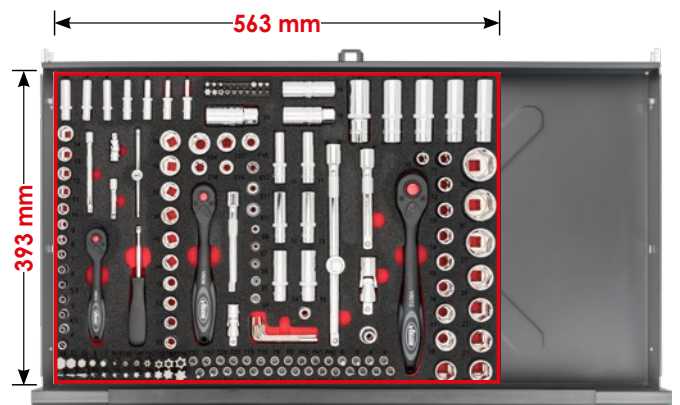

V1000 XD
6/3+

3/3+	3/3+
V1000	V1000

VIGOR 1000 XD

V1000 XL
4/3+

VIGOR 1000 XL

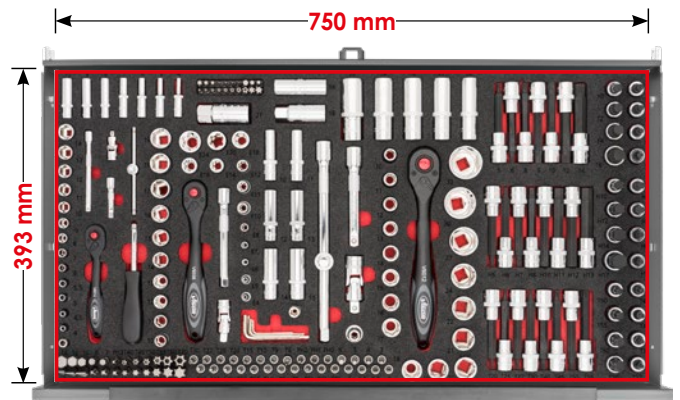
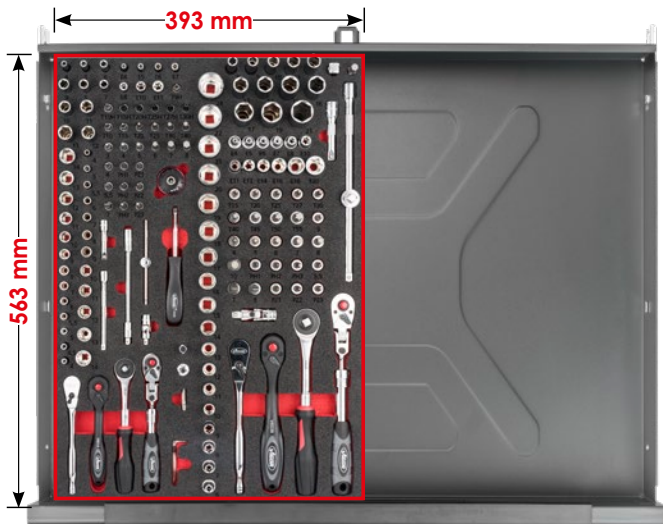

Soft foam inserts



V6222, EAN 4047728062374
Hammer, chisel and drift pin set



X	Design	Size mm
1 x		120 mm
1 x		150 mm
1 x		150 mm
1 x		320 mm
1 x		140 mm

X	Design	Size mm
1 x		150 mm
1 x		180 mm
1 x		200 mm
1 x		210 mm
1 x		210 mm
1 x		220 mm



V6222-L, EAN 4047728062633
Soft foam insert, empty



V4971, EAN 4047728049719
Socket tool set



X	■	Design	Size mm
13 x	6.3 1/4		4 · 4.5 · 5 · 5.5 · 6 · 7 · 8 · 9 · 10 · 11 · 12 · 13 · 14
7 x	6.3 1/4		4 · 5 · 6 · 7 · 8 · 9 · 10
7 x	6.3 1/4		E4 · E5 · E6 · E7 · E8 · E10 · E11
6 x	6.3 1/4		3 · 4 · 5 · 6 · 7 · 8
3 x	6.3 1/4		PH1 · PH2 · PH3
3 x	6.3 1/4		0.8x4 · 1x5.5-1.2x7
3 x	6.3 1/4		PZ1 · PZ2 · PZ3
6 x	6.3 1/4		T10 · T15 · T20 · T25 · T30 · T40

X	■	Design	Size mm
7 x	6.3 1/4		T9H · T10H · T115H · T25H · T27H · T30H · T20H
1 x	-	6.3 1/4	150 mm
1 x	6.3 1/4	6.3 1/4	40 mm
1 x	10 3/8	6.3 1/4	27 mm
1 x	6.3 1/4	6.3 1/4	110 mm
1 x	6.3 1/4	6.3 1/4	145 mm
1 x	6.3 1/4	6.3 1/4	50 mm
1 x	6.3 1/4	6.3 1/4	100 mm
4 x	-		1.27 · 1.5 · 2 · 2.5
1 x	-	6.3 1/4	150 mm



V4971-L, EAN 4047728049702
Soft foam insert, empty



V4973, EAN 4047728049733
Socket tool set



X	■	Design	Size mm
18 x	10 3/8		6 · 7 · 8 · 9 · 10 · 11 · 12 · 13 · 14 · 15 · 16 · 17 · 18 · 19 · 20 · 21 · 22 · 24
10 x	10 3/8		8 · 9 · 10 · 11 · 12 · 13 · 14 · 15 · 17 · 19
7 x	10 3/8		3 · 4 · 5 · 6 · 7 · 8 · 10
3 x	10 3/8		0.8x5.5 · 1x7 · 1.2x8
3 x	10 3/8		PH1 · PH2 · PH3
3 x	10 3/8		PZ1 · PZ2 · PZ3

X	■	Design	Size mm
9 x	10 3/8		T15 · T20 · T25 · T27 · T30 · T40 · T45 · T50 · T55
2 x	10 3/8		16 · 21
1 x	10 3/8	8 3/8	28 mm
1 x	12 1/2	10 3/8	40 mm
1 x	10 3/8	10 3/8	50 mm
1 x	10 3/8	10 3/8	75 mm
1 x	10 3/8	10 3/8	250 mm
1 x	-	10 3/8	198 mm



V4973-L, EAN 4047728049726
Soft foam insert, empty



V4975, EAN 4047728049757

Socket tool set



25

2K

1/3 +



X	■		Design	Size mm
18 x	125 1/2	●		10 · 11 · 12 · 13 · 14 · 15 · 16 · 17 · 18 · 19 · 20 · 21 · 22 · 23 · 24 · 27 · 30 · 32
2 x	125 1/2	●		16 · 21
1 x	-	125 1/2		250 mm

X	■		Design	Size mm
1 x	125 1/2	125 1/2		75 mm
1 x	125 1/2	125 1/2		125 mm
1 x	125 1/2	125 1/2		250 mm
1 x	-	125 1/2		250 mm

V4975-L, EAN 4047728049740

Soft foam insert, empty



V4977, EAN 4047728049771

Socket set, long

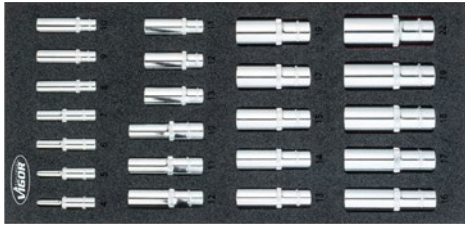

23

2K

1/3 +



X	■		Design	Size mm
8 x	10 3/8	●		10 · 11 · 12 · 13 · 14 · 15 · 17 · 19
5 x	125 1/2	●		16 · 17 · 18 · 19 · 22

X	■		Design	Size mm
10 x	6.3 1/4	●		4 · 5 · 6 · 7 · 8 · 9 · 10 · 11 · 12 · 13

V4977-L, EAN 4047728049764

Soft foam insert, empty



V5602, EAN 4047728056021

Impact socket set



26

2K

1/3 +



X	■		Design	Size mm
13 x	125 1/2	●		10 · 11 · 12 · 13 · 14 · 15 · 16 · 17 · 18 · 19 · 21 · 22 · 24

X	■		Design	Size mm
13 x	125 1/2	●		10 · 11 · 12 · 13 · 14 · 15 · 16 · 17 · 18 · 19 · 21 · 22 · 24

V5602-L, EAN 4047728056038

Soft foam insert, empty



V5099, EAN 4047728050999

Screwdriver socket set

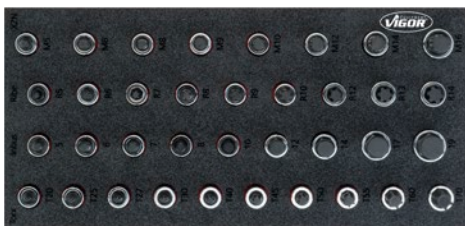

36

2K

1/3 +



X	■		Design	Size mm
10 x	125 1/2	●		T20 · T25 · T27 · T30 · T40 · T45 · T50 · T55 · T60 · T70
9 x	125 1/2	●		M5 · M6 · M7 · M8 · M9 · M10 · M12 · M13 · M14

X	■		Design	Size mm
9 x	125 1/2	○		5 · 6 · 7 · 8 · 10 · 12 · 14 · 17 · 19
8 x	125 1/2	○		M5 · M6 · M8 · M9 · M10 · M12 · M14 · M16

V5099-L, EAN 4047728051002

Soft foam insert, empty



Soft foam inserts



V5095, EAN 4047728050951
TORX® screwdriver socket set



26

2K

1/3 +



X	■		Design	Size mm
6 x				T40 · T45 · T50 · T55 · T60 · T70
10 x				T20 · T25 · T27 · T30 · T40 · T45 · T50 · T55 · T60 · T70

X	■		Design	Size mm
10 x				T20 · T25 · T27 · T30 · T40 · T45 · T50 · T55 · T60 · T70

V5095-L, EAN 4047728050968
Soft foam insert, empty



V5091, EAN 4047728050913
XZN Serration screwdriver socket set

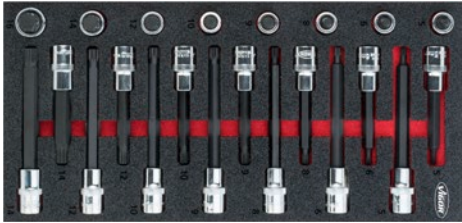

22

2K

1/3 +



X	■		Design	Size mm
7 x				M5 · M6 · M8 · M10 · M9 · M12 · M14
7 x				M5 · M6 · M8 · M9 · M10 · M12 · M14

X	■		Design	Size mm
8 x				M5 · M6 · M8 · M9 · M10 · M12 · M14 · 16 ·

V5091-L, EAN 4047728050920
Soft foam insert, empty



V5097, EAN 4047728050975
Screwdriver socket set for inside hexagon screws



24

2K

1/3 +



X	■		Design	Size mm
7 x				5 · 6 · 7 · 8 · 10 · 12 · 14
8 x				5 · 6 · 7 · 8 · 10 · 11 · 12 · 13

X	■		Design	Size mm
9 x				5 · 6 · 7 · 8 · 10 · 12 · 14 · 17 · 19

V5097-L, EAN 4047728050982
Soft foam insert, empty



V5093, EAN 4047728050937
Ribe CV screwdriver socket set



25

2K

1/3 +



X	■		Design	Size mm
7 x				M8 · M9 · M10 · M10.3 · M12 · M13 · M14
9 x				M5 · M6 · M7 · M8 · M9 · M10 · M12 · M13 · M14

X	■		Design	Size mm
9 x				M5 · M6 · M7 · M8 · M9 · M10 · M12 · M13 · M14

V5093-L, EAN 4047728050944
Soft foam insert, empty



V6721, EAN 4047728**067461**
Double open-end wrench set

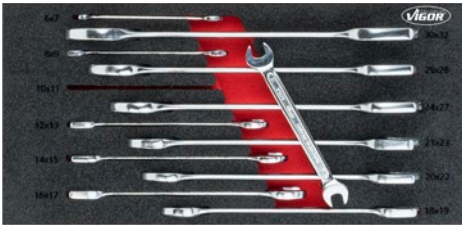

12

2K

1/3 +



X	Design	Size mm
12 x		6 x 7 · 8 x 9 · 10 x 11 · 12 x 13 · 14 x 15 · 16 x 17 · 18 x 19 · 20 x 22 · 21 x 23 · 24 x 27 · 25 x 28 · 30 x 32

V6721-L, EAN 4047728**067218**
Soft foam insert, empty



V6723, EAN 4047728**067485**
Combination wrench set

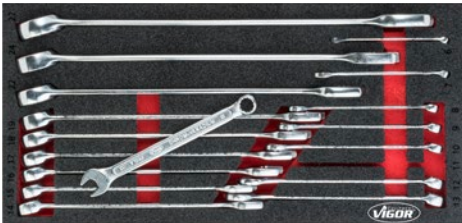

17

2K

1/3 +



X	Design	Size mm
17 x		6 · 7 · 8 · 9 · 10 · 11 · 12 · 13 · 14 · 15 · 16 · 17 · 18 · 19 · 22 · 24 · 27

V6723-L, EAN 4047728**067232**
Soft foam insert, empty



V6722, EAN 4047728**067478**
Double box-end wrench set

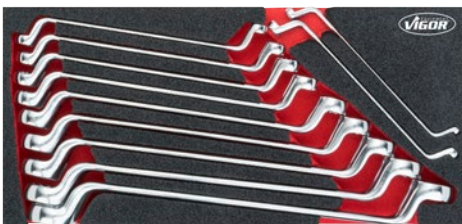

11

2K

1/3 +



X	Design	Size mm
11 x		6 x 7 · 8 x 9 · 10 x 11 · 12 x 13 · 14 x 15 · 16 x 17 · 18 x 19 · 20 x 22 · 21 x 23 · 24 x 27 · 25 x 28

V6722-L, EAN 4047728**067225**
Soft foam insert, empty



V5075, EAN 4047728**050753**
Ratcheting combination wrench set, short



12

2K

1/3 +



X	Design	Size mm
12 x		8 · 9 · 10 · 11 · 12 · 13 · 14 · 15 · 16 · 17 · 18 · 19

V5075-L, EAN 4047728**050760**
Soft foam insert, empty



Soft foam inserts



V4987, EAN 4047728**049870**
Ratcheting combination wrench set

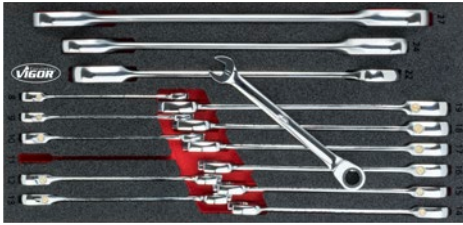

15

2K

1/3 +



X	Design	Size mm
15 x		8 · 9 · 10 · 11 · 12 · 13 · 14 · 15 · 16 · 17 · 18 · 19 · 22 · 24 · 27

V4987-L, EAN 4047728**049863**
Soft foam insert, empty



V5077, EAN 4047728**050777**
Ratcheting combination wrench set, with hinge

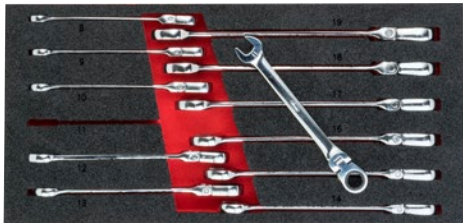

12

2K

1/3 +



X	Design	Size mm
12 x		8 · 9 · 10 · 11 · 12 · 13 · 14 · 15 · 16 · 17 · 18 · 19

V5077-L, EAN 4047728**050784**
Soft foam insert, empty



V4989, EAN 4047728**049894**
Screwdriver set



12

2K

1/3 +



X	Design	Size mm	X	Design	Size mm
6 x		0.6x3 · 0.8x4 · 1.0x5.5 · 1.2x6.5 · 1.6x8 · 1.6x10	1 x		1x5.5
4 x		PH0 · PH1 · PH2 · PH3	1 x		PH2

V4989-L, EAN 4047728**049887**
Soft foam insert, empty



V5068, EAN 4047728**050685**
Screwdriver set with impact cap



10

2K

1/3 +



X	Design	Size mm	X	Design	Size mm
3 x		PH1 · PH2 · PH3	7 x		0.6x3.5 · 1.0x4.5 · 1x5.5 · 1.2x6.5 · 1.6x8 · 1.6x10 · 2x12

V5068-L, EAN 4047728**050678**
Soft foam insert, empty



V4991, EAN 4047728**049917**

TORX® screwdriver set

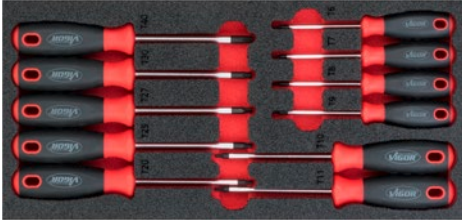

11

2K

1/3 +



X	Design	Size mm
11 x		T6 · T7 · T8 · T9 · T10 · T15 · T20 · T25 · T27 · T30 · T40

V4991-L, EAN 4047728**049900**

Soft foam insert, empty



V4997, EAN 4047728**049979**

Hex nut-driver set

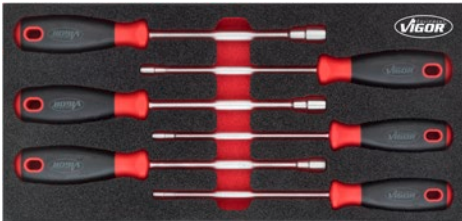

6

2K

1/3 +



X	Design	Size mm
6 x		6 · 7 · 8 · 10 · 12 · 13

V4997-L, EAN 4047728**049962**

Soft foam insert, empty



V5070, EAN 4047728**050708**

Hook and scraper set



9

2K

1/3 +



X	Design	Size mm	X	Design	Size mm
1 x		130 mm	1 x		260 mm

V5070-L, EAN 4047728**050692**

Soft foam insert, empty



V5017, EAN 4047728**050173**

Scraper set



16

2K

1/3 +



X	Design	Size mm	X	Design	Size mm
1 x		-	1 x		175 mm
1 x		265 mm	1 x		175 mm
1 x		230 mm			
1 x		230 mm	1 x		-

V5017-L, EAN 4047728**050166**

Soft foam insert, empty



Soft foam inserts



V5633, EAN 4047728056335
Pliers set



X	Design	Size mm
1 x		250 mm
1 x		160 mm

X	Design	Size mm
1 x		200 mm
1 x		180 mm

V5633-L, EAN 4047728056342
Soft foam insert, empty



V4995, EAN 4047728049955
Double joint pliers set

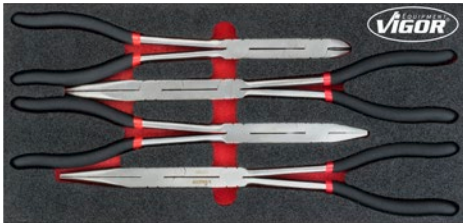

X	Design	Size mm
1 x		340 mm
1 x		335 mm

X	Design	Size mm
1 x		300 mm
1 x		290 mm

V4995-L, EAN 4047728049948
Soft foam insert, empty



V4999, EAN 4047728049993
Circlip pliers set



X	Design	Size mm
1 x		180 mm
1 x		180 mm
1 x		180 mm

X	Design	Size mm
1 x		180 mm
1 x		140 mm
1 x		140 mm

V4999-L, EAN 4047728049986
Soft foam insert, empty



V5004, EAN 4047728050043
Grip pliers set



X	Design	Size mm
1 x		16-27
1 x		11-19
1 x		125 mm

X	Design	Size mm
1 x		250 mm
1 x		150 mm

V5004-L, EAN 4047728050005
Soft foam insert, empty



V5006, EAN 4047728050067
Pliers, hammer and chisel set



11

2K

1/3 +



X	Design	Size mm
1 x		150 mm
1 x		150 mm
1 x		120 mm
1 x		150 mm
1 x		150 mm
1 x		150 mm

X	Design	Size mm
1 x		150 mm
1 x		150 mm
1 x		150 mm
1 x		320 mm
1 x		350 mm

V5006-L, EAN 4047728050050
Soft foam insert, empty



V5072, EAN 4047728050722
File set

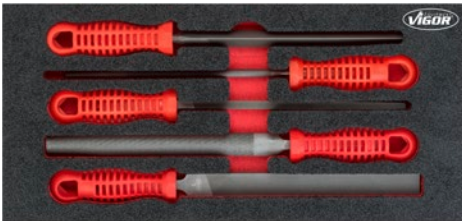

5

2K

1/3 +



X	Design
1 x	
1 x	
1 x	

X	Design
1 x	
1 x	

V5072-L, EAN 4047728050715
Soft foam insert, empty



V5011, EAN 4047728050111
VDE socket set

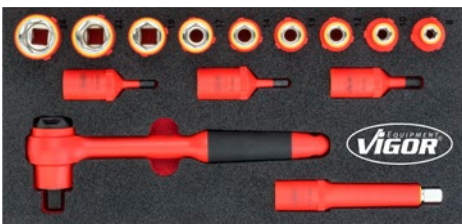

14

2K

1/3 +



X	Design	Size mm
9 x		8 · 10 · 12 · 13 · 14 · 17 · 19 · 22 · 24
3 x		5 · 6 · 8

X	Design	Size mm
1 x		125 mm
1 x		255 mm

V5011-L, EAN 4047728050104
Soft foam insert, empty



V5013, EAN 4047728050135
VDE screwdriver set



8

2K

1/3 +



X	Design	Size mm
3 x		PH0 · PH1 · PH2
4 x		0.5 x 3 · 0.8 x 4 · 1 x 5.5 · 1.2 x 6.5

X	Design	Size mm
1 x		3x0.5

V5013-L, EAN 4047728050128
Soft foam insert, empty



Soft foam inserts



V5015, EAN 4047728050159
VDE pliers set

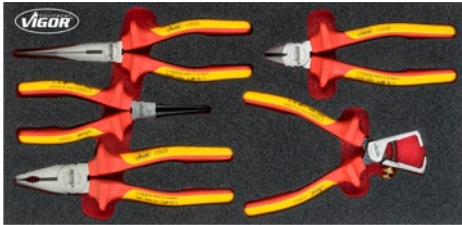

X	Design	Size mm
1 x		180 mm
1 x		160 mm
1 x		160 mm

X	Design	Size mm
1 x		200 mm
1 x		160 mm

V5015-L, EAN 4047728050142
Soft foam insert, empty



V5103, EAN 4047728051033

Socket set



71

2K

1/2 +



X			Design	Size mm	
13 x	6.3	1/4		4 · 4.5 · 5 · 5.5 · 6 · 7 · 8 · 9 · 10 · 11 · 12 · 13 · 14	
6 x	6.3	1/4		3 · 4 · 5 · 6 · 7 · 8	
3 x	6.3	1/4		PH1 · PH2 · PH3	
3 x	6.3	1/4		PZ1 · PZ2 · PZ3	
3 x	6.3	1/4		0.8x4 · 1x5.5 · 1.2x7	
6 x	6.3	1/4		T10 · T15 · T20 · T25 · T30 · T40	
1 x	-	6.3	1/4	150 mm	
1 x	6.3	1/4	6.3	1/4	110 mm
1 x	6.3	1/4	6.3	1/4	40 mm
1 x	6.3	1/4	6.3	1/4	145 mm
1 x	6.3	1/4	6.3	1/4	50 mm

X			Design	Size mm	
1 x	6.3	1/4	6.3	1/4	100 mm
18 x	12.5	1/2		10 · 11 · 12 · 13 · 14 · 15 · 16 · 17 · 18 · 19 · 20 · 21 · 22 · 23 · 24 · 27 · 30 · 32	
2 x	12.5	1/2		21 · 16	
1 x	-	12.5	1/2	250 mm	
1 x	12.5	1/2	12.5	1/2	75 mm
1 x	12.5	1/2	12.5	1/2	125 mm
1 x	12.5	1/2	12.5	1/2	250 mm
4 x	-			1.27 · 1.5 · 2 · 2.5	
1 x	-	6.3	1/4	150 mm	
1 x	-	12.5	1/2	250 mm	

V5103-L, EAN 4047728051040

Soft foam insert, empty



V5087, EAN 4047728050876

VDE tool set



13

2K

1/2 +



X		Design	Size mm
1 x			3x0.5
1 x	-		160 mm
1 x	-		160 mm
1 x	-		180 mm

X		Design	Size mm
1 x	-		200 mm
1 x	-		160 mm
4 x			0.5x3 · 0.8x4 · 1x5.5 · 1.2x6.5
3 x			PH0 · PH1 · PH2

V5087-L, EAN 4047728050883

Soft foam insert, empty



Soft foam inserts



V5081, EAN 4047728**050814**
Screwdriver set



31

2K

1/2 +



X	Design	Size mm
1 x		T10 - T50
1 x		3x0.5
1 x		1.5 - 10
6 x		0.6 x 3 · 0.8 x 4 · 1.0 x 5.5 · 1.6 x 8 · 1.6 x 10 · 1.2 x 6.5

X	Design	Size mm
4 x		PH0 · PH1 · PH2 · PH3
1 x		1x5.5
1 x		PH2

V5081-L, EAN 4047728**050821**
Soft foam insert, empty



V5085, EAN 4047728**050852**
Hammer and chisel set



14

2K

1/2 +



X	Design	Size mm
1 x		150 mm
1 x		175 mm
1 x		150 mm
1 x		120 mm
1 x		150 mm
1 x		150 mm
1 x		150 mm

X	Design	Size mm
1 x		150 mm
1 x		150 mm
1 x		150 mm
1 x		280 mm
1 x		230 mm
1 x		350 mm
1 x		280 mm

V5085-L, EAN 4047728**050869**
Soft foam insert, empty



V4188, EAN 4047728041881

Socket tool set

172

2K

V1000
3/3+



X	■	⊕	Design	Size mm	X	■	⊕	Design	Size mm
5 x	6.3 1/4	⊕		R5 · R6 · R7 · R8 · R9	6 x	10 3/8	⊕		E10 · E11 · E12 · E14 · E16 · E18
3 x	6.3 1/4	⊕		T5 · T6 · T7	6 x	10 3/8	⊕		10 · 11 · 12 · 13 · 14 · 15
3 x	6.3 1/4	⊕		M5 · M6 · M8	10 x	10 3/8	⊕		10 · 11 · 12 · 13 · 14 · 15 · 16 · 17 · 18 · 19
9 x	6.3 1/4	⊕		T7H · T10H · T15H · T20H · T25H · T27H · T30H · T40H · T45H	17 x	12 1/2	⊕		10 · 11 · 12 · 13 · 14 · 15 · 16 · 17 · 18 · 19 · 20 · 21 · 22 · 24 · 27 · 30 · 32
6 x	8 5/8	⊕		T40 · T45 · T50 · T55 · T60 · T70	5 x	12 1/2	⊕		16 · 17 · 18 · 19 · 22
5 x	8 5/8	⊕		7 · 8 · 10 · 12 · 14	2 x	12 1/2	⊕		E20 · E22
2 x	8 5/8	⊕		PH3 · PH4	13 x	6.3 1/4	⊕		4 · 4.5 · 5 · 5.5 · 6 · 7 · 8 · 9 · 10 · 11 · 12 · 13 · 14
2 x	8 5/8	⊕		PZ3 · PZ4	7 x	6.3 1/4	⊕		4 · 5 · 6 · 7 · 8 · 9 · 10
3 x	8 5/8	⊕		8 · 10 · 12	5 x	6.3 1/4	⊕		E4 · E5 · E6 · E7 · E8
6 x	8 5/8	⊕		T40H · T45H · T50H · T55H · T60H · T70H	1 x	-	6.3 1/4		150 mm
4 x	-	⊕		1.27 · 1.5 · 2 · 2.5	1 x	-	6.3 1/4		150 mm
1 x	6.3 1/4	6.3 1/4		30 mm	1 x	-	10 3/8		198 mm
1 x	10 3/8	8 5/8		28 mm	1 x	-	12 1/2		250 mm
1 x	12 1/2	8 5/8		37 mm	1 x	6.3 1/4	6.3 1/4		40 mm
1 x	6.3 1/4	6.3 1/4		110 mm	1 x	10 3/8	10 3/8		50 mm
1 x	-	12 1/2		43.7 mm	1 x	12 1/2	12 1/2		75 mm
4 x	6.3 1/4	⊕		3 · 4 · 5 · 6	1 x	6.3 1/4	6.3 1/4		50 mm
4 x	6.3 1/4	⊕		0.8x4-1x5.5 · 1.2x6.5 · 1.2x7	1 x	6.3 1/4	6.3 1/4		100 mm
3 x	6.3 1/4	⊕		PH0 · PH1 · PH2	1 x	10 3/8	10 3/8		125 mm
3 x	6.3 1/4	⊕		PZ0 · PZ1 · PZ2	1 x	12 1/2	12 1/2		125 mm
6 x	6.3 1/4	⊕		T9 · T10 · T15 · T20 · T25 · T30	1 x	12 1/2	12 1/2		250 mm
7 x	6.3 1/4	⊕		T9H · T10H · T15H · T20H · T25H · T27H · T30H	1 x	10 3/8	⊕		18
					2 x	12 1/2	⊕		16 · 21

V4130, EAN 4047728041300

Soft foam insert, empty



Soft foam inserts



V4587, EAN 4047728**045872**
Socket set for VW and AUDI

102
2K
V1000
3/3+

	X	■		Design	Size mm	X	■		Design	Size mm
17 x	12 ²⁵ 1/2	6.3 1/4	●		10 · 12 · 13 · 14 · 15 · 16 · 18 · 17 · 19 · 21 · 22 · 24 · 27 · 30 · 32 · 8 · 9	1 x	-	6.3 1/4		150 mm
1 x	6.3 1/4	10 3/8	●		26 mm	17 x	12 ²⁵ 1/2	●		10 · 15 · 16 · 17 · 18 · 19 · 20 · 21 · 22 · 24 · 27 · 30 · 32 · 13 · 14 · 12 · 11
1 x	10 3/8	6.3 1/4	●		27 mm	1 x	-	●		17
1 x	10 3/8	12 ²⁵ 1/2	●		36 mm	1 x	-	●		19
1 x	12 ²⁵ 1/2	10 3/8	●		36 mm	1 x	-	12 ²⁵ 1/2		250 mm
8 x	12 ²⁵ 1/2	●	⊕		T25 · T27 · T30 · T40 · T45 · T50 · T55 · T60	1 x	12 ²⁵ 1/2	12 ²⁵ 1/2		75 mm
4 x	6.3 1/4	●	●		E4 · E5 · E6 · E8	1 x	12 ²⁵ 1/2	12 ²⁵ 1/2		50 mm
6 x	12 ²⁵ 1/2	●	⊕		E18 · E20 · E10 · E12 · E14 · E16	1 x	12 ²⁵ 1/2	12 ²⁵ 1/2		75 mm
12 x	6.3 1/4	●	●		4 · 5 · 5.5 · 6 · 7 · 8 · 9 · 10 · 11 · 12 · 13 · 14	1 x	12 ²⁵ 1/2	●		250 mm
1 x	6.3 1/4	●	●		1 x 5.5	5 x	6.3 1/4	⊕		T10 · T15 · T20 · T25 · T27
4 x	6.3 1/4	●	●		3 · 4 · 5 · 6	1 x	12 ²⁵ 1/2	●		32
2 x	6.3 1/4	⊕	⊕		PH1 · PH2	1 x	12 ²⁵ 1/2	●		36
1 x	6.3 1/4	6.3 1/4	●		40 mm	1 x	6.3 1/4	6.3 1/4		25 mm
1 x	6.3 1/4	6.3 1/4	●		50 mm	1 x	20 3/4	12 ²⁵ 1/2		50 mm
1 x	6.3 1/4	6.3 1/4	●		100 mm	1 x	12 ²⁵ 1/2	20 3/4		46 mm
						1 x	-	12 ²⁵ 1/2		250 mm
						1 x	-	6.3 1/4		150 mm

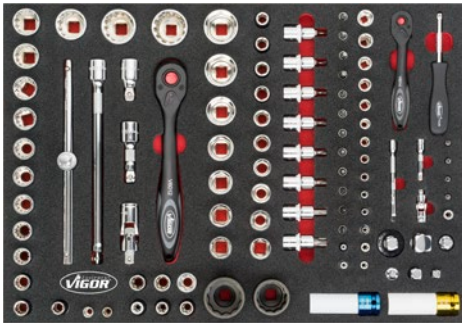

V4514, EAN 4047728**045148**
Soft foam insert, empty



V5115, EAN 4047728**051293**
Socket set

79
2K
V1000
3/3+

	X	■		Design	Size mm	X	■		Design	Size mm
12 x	6.3 1/4	●	●		4 · 5 · 5.5 · 6 · 7 · 8 · 9 · 10 · 11 · 12 · 13 · 14	1 x	6.3 1/4	6.3 1/4		40 mm
17 x	12 ²⁵ 1/2	●	●		10 · 11 · 12 · 13 · 14 · 15 · 17 · 16 · 18 · 19 · 20 · 21 · 22 · 24 · 27 · 30 · 32	1 x	6.3 1/4	6.3 1/4		50 mm
						1 x	6.3 1/4	6.3 1/4		100 mm
1 x	6.3 1/4	●	●		-	1 x	-	12 ²⁵ 1/2		43.7 mm
						1 x	6.3 1/4	10 3/8		26 mm
						1 x	10 3/8	6.3 1/4		27 mm
						1 x	10 3/8	12 ²⁵ 1/2		36 mm
						1 x	12 ²⁵ 1/2	10 3/8		36 mm
						1 x	12 ²⁵ 1/2	20 3/4		46 mm
						1 x	20 3/4	12 ²⁵ 1/2		50 mm
						1 x	-	12 ²⁵ 1/2		250 mm
						1 x	-	6.3 1/4		150 mm



V5115-L, EAN 4047728**051811**
Soft foam insert, empty



V2837, EAN 4047728028370

Socket set

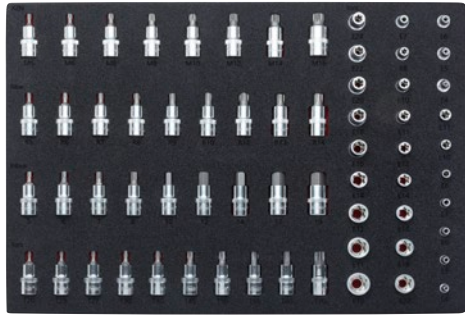

64

2K

V1000
3/3+



X	■		Design	Size mm	X	■		Design	Size mm
7 x	6.3	1/4		E4 · E5 · E6 · E7 · E8 · E10 · E11	8 x	12.5	1/2		M5 · M6 · M8 · M9 · M10 · M12 · M14 · M16
12 x	10	3/8		E4 · E5 · E6 · E7 · E8 · E10 · E11 · E12 · E14 · E16 · E18 · E20	9 x	12.5	1/2		5 · 6 · 7 · 8 · 10 · 12 · 14 · 17 · 19
9 x	12.5	1/2		E10 · E11 · E12 · E14 · E16 · E18 · E20 · E22 · E24	9 x	12.5	1/2		M5 · M6 · M7 · M8 · M9 · M10 · M12 · M13 · M14
					10 x	12.5	1/2		T20 · T25 · T27 · T30 · T40 · T45 · T50 · T55 · T60 · T70

V2838, EAN 4047728028387

Soft foam insert, empty



V4753, EAN 4047728047531

Screwdriver socket set

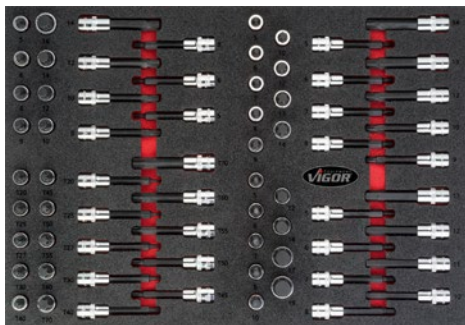

70

2K

V1000
3/3+



X	■		Design	Size mm	X	■		Design	Size mm
8 x	12.5	1/2		5 · 6 · 7 · 8 · 10 · 11 · 12 · 13	7 x	12.5	1/2		M5 · M6 · M8 · M9 · M10 · M12 · M14
9 x	12.5	1/2		M5 · M6 · M7 · M8 · M9 · M10 · M12 · M13 · M14	10 x	12.5	1/2		T20 · T25 · T27 · T30 · T40 · T45 · T50 · T55 · T60 · T70
9 x	12.5	1/2		5 · 6 · 7 · 8 · 10 · 12 · 14 · 17 · 19	10 x	12.5	1/2		T20 · T25 · T27 · T30 · T40 · T45 · T50 · T55 · T60 · T70
9 x	12.5	1/2		M5 · M6 · M7 · M8 · M9 · M10 · M12 · M13 · M14	8 x	12.5	1/2		M5 · M6 · M8 · M9 · M10 · M12 · M14 · M16

V4752, EAN 4047728047524

Soft foam insert, empty



V4727, EAN 4047728047272

Screwdriver socket set

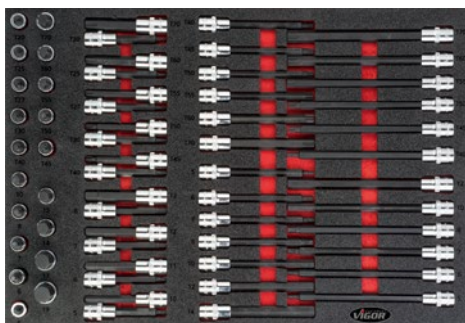

62

2K

V1000
3/3+



X	■		Design	Size mm	X	■		Design	Size mm
10 x	12.5	1/2		T20 · T25 · T27 · T30 · T40 · T45 · T50 · T55 · T60 · T70	6 x	12.5	1/2		T40 · T45 · T50 · T55 · T60 · T70
10 x	12.5	1/2		T20 · T25 · T27 · T30 · T40 · T45 · T50 · T55 · T60 · T70	9 x	12.5	1/2		5 · 6 · 7 · 8 · 10 · 12 · 14 · 17 · 19
6 x	12.5	1/2		T40 · T45 · T50 · T55 · T60 · T70	8 x	12.5	1/2		5 · 6 · 7 · 8 · 10 · 11 · 12 · 13
					7 x	12.5	1/2		5 · 6 · 7 · 8 · 10 · 12 · 14
					6 x	12.5	1/2		5 · 6 · 7 · 8 · 10 · 12

V4726, EAN 4047728047265

Soft foam insert, empty



Soft foam inserts



V4729, EAN 4047728**047296**
Screwdriver socket set

58
2K
V1000
3/3+

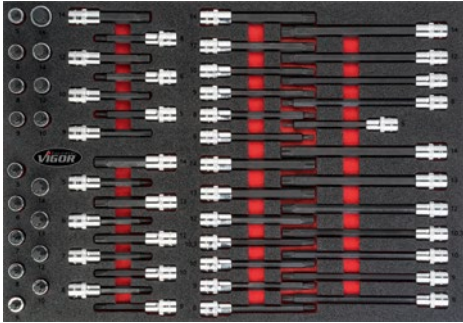

X	■		Design	Size mm
8 x	12.9	1/2		M5 · M6 · M8 · M9 · M10 · M12 · M14 · M16
7 x	12.9	1/2		M5 · M6 · M8 · M9 · M10 · M12 · M14
7 x	12.9	1/2		M5 · M6 · M8 · M9 · M10 · M12 · M14
4 x	12.9	1/2		M8 · M10 · M12 · M14

X	■		Design	Size mm
9 x	12.9	1/2		M5 · M6 · M7 · M8 · M9 · M10 · M12 · M13 · M14
9 x	12.9	1/2		M5 · M6 · M7 · M8 · M9 · M10 · M12 · M13 · M14
7 x	12.9	1/2		M8 · M9 · M10 · M10.3 · M12 · M13 · M14
7 x	12.9	1/2		M8 · M9 · M10 · M10.3 · M12 · M13 · M14

V4728, EAN 4047728**047289**
Soft foam insert, empty



V5109, EAN 4047728**051095**
Socket set

21
2K
V1000
3/3+



X	■		Design	Size mm
16 x	20	3/4		19 · 21 · 22 · 23 · 24 · 26 · 27 · 28 · 30 · 32 · 34 · 36 · 38 · 41 · 46 · 50
1 x	-	20		500 mm

X	■		Design	Size mm
1 x	20	3/4		200 mm
1 x	20	3/4		100 mm
1 x	20	3/4		400 mm
1 x	-	20		450 mm

V5109-L, EAN 4047728**051101**
Soft foam insert, empty



V6649, EAN 4047728**067447**
Combination wrench / double box-end wrench set for VW and AUDI

25
2K
V1000
3/3+

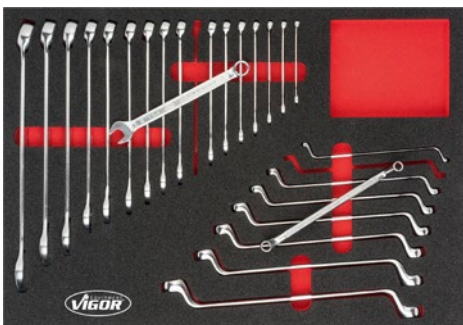

X	Design	Size mm
17 x		6 · 7 · 8 · 9 · 10 · 11 · 12 · 13 · 14 · 15 · 16 · 17 · 18 · 19 · 21 · 22 · 24

X	Design	Size mm
8 x		6x7 · 8x9 · 10x11 · 12x13 · 14x15 · 16x17 · 18x19 · 21x23

V6649-L, EAN 4047728**066495**
Soft foam insert, empty



V6726, EAN 4047728**067515**

Double open-end, double box-end and combination wrench set

29

2K

V1000
3/3+

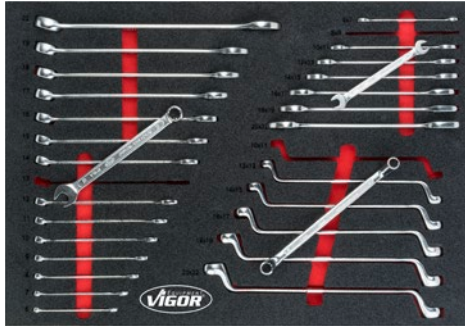

X		Design	Size mm
8 x			6x7 · 8x9 · 10x11 · 12x13 · 14x15 · 16x17 · 18x19 · 20x22
6 x			10x11 · 12x13 · 14x15 · 16x17 · 18x19 · 20x22

X		Design	Size mm
15 x			6 · 7 · 8 · 9 · 10 · 11 · 12 · 13 · 14 · 15 · 16 · 17 · 18 · 19 · 22

V6726-L, EAN 4047728**067263**

Soft foam insert, empty



V6643, EAN 4047728**067430**

Double box-end wrench, double open-end wrench, combination wrench set

36

2K

V1000
3/3+



X		Design	Size mm
9 x			6x7 · 8x9 · 10x11 · 12x13 · 14x15 · 16x17 · 18x19 · 20x22 · 21x23

X		Design	Size mm
10 x			6x7 · 8x9 · 10x11 · 12x13 · 14x15 · 16x17 · 18x19 · 20x22 · 21x23 · 24x27
17 x			6 · 7 · 8 · 9 · 10 · 11 · 12 · 13 · 14 · 15 · 16 · 17 · 18 · 19 · 22 · 24 · 27

V6643-L, EAN 4047728**066433**

Soft foam insert, empty



Soft foam inserts



V6725, EAN 4047728067508
 Double box-end wrench and double open-end wrench set

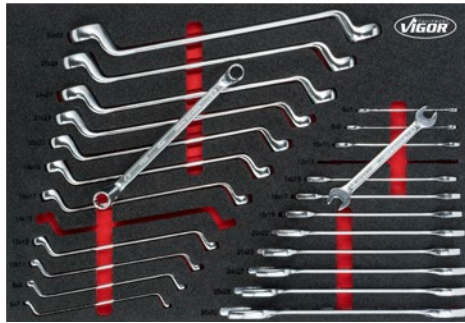

24

2K

V1000
3/3+



X		Design	Size mm
12 x	●		6 x 7 · 8 x 9 · 10 x 11 · 12 x 13 · 14 x 15 · 16 x 17 · 18 x 19 · 20 x 22 · 21 x 23 · 24 x 27 · 25 x 28 · 30 x 32

X		Design	Size mm
12 x	●		6 x 7 · 8 x 9 · 10 x 11 · 12 x 13 · 14 x 15 · 16 x 17 · 18 x 19 · 20 x 22 · 21 x 23 · 24 x 27 · 25 x 28 · 30 x 32

V6725-L, EAN 4047728067256
 Soft foam insert, empty



V6820, EAN 4047728071147
 Combination wrench, extension, pry bar set for VW and AUDI

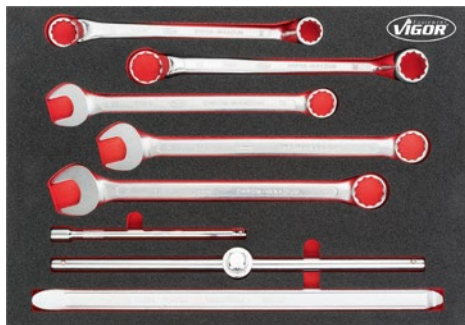

8

2K

V1000
3/3+



X			Design	Size mm
2 x	-	●		24 x 27 · 30 x 32
3 x	-	●		27 · 30 · 32

X			Design	Size mm
1 x	-	20 3/4"		450 mm
1 x	12 1/2"	12 1/2"		250 mm
1 x	-	-		500 mm

V6820-L, EAN 4047728071130
 Soft foam insert, empty



V5173, EAN 4047728051736
 Socket, offset screwdriver, ratcheting combination wrench set

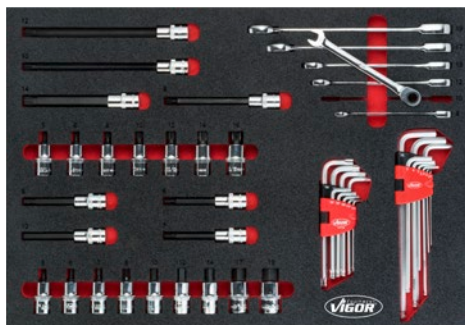

48

2K

V1000
3/3+



X			Design	Size mm
1 x	-	○		1.5 - 10
1 x	-	○		T10 - T50
2 x	12 1/2"	1/2"		M8 - M14
2 x	12 1/2"	1/2"		M10 - M12
7 x	12 1/2"	1/2"		M5 · M6 · M8 · M10 · M14 · M16 · M12

X			Design	Size mm
4 x	12 1/2"	1/2"		6 · 7 · 8 · 10
9 x	12 1/2"	1/2"		5 · 6 · 7 · 8 · 10 · 12 · 14 · 17 · 19
6 x	-	●		8 · 10 · 12 · 13 · 17 · 19

V5173-L, EAN 4047728051743
 Soft foam insert, empty



V4588, EAN 4047728**045889**
Screwdriver set for VW and AUDI



26

2K

V1000
3/3+

X	Design	Size mm
10 x		T6 · T7 · T8 · T9 · T10 · T15 · T20 · T25 · T27 · T30
2 x		PH1 · PH2
3 x		1x5.5 · 1.2x6.5 · 1.0x4.5
3 x		PH3 · PH1 · PH2

X	Design	Size mm
6 x		1.6x8 · 1.6x10 · 0.6x3 · 0.8x4 · 1.0x5.5 · 1.2x6.5
1 x		1x5.5
1 x		PH2

V4501, EAN 4047728**045018**
Soft foam insert, empty

V4230, EAN 4047728**042307**
Screwdriver set



32

2K

V1000
3/3+

X	Design	Size mm
6 x		6 · 7 · 8 · 10 · 12 · 13
6 x		0.6x3 · 0.8x4 · 1.0x5.5 · 1.2x6.5 · 1.6x10 · 1.6x8
4 x		PH0 · PH1 · PH2 · PH3
1 x		1x5.5

X	Design	Size mm
1 x		PH2
7 x		T10 · T15 · T20 · T25 · T27 · T30 · T40
1 x		3x0.5
2 x		PH1 · PH2
4 x		0.6x3.5 · 1.0x4.5 · 1x5.5 · 1.2x6.5

V4231, EAN 4047728**042314**
Soft foam insert, empty

V5175, EAN 4047728**051750**
T-handle screwdriver and offset screwdriver set



34

2K

V1000
3/3+

X	Design	Size mm
1 x		1.5 - 10
1 x		T10 - T50

X	Design	Size mm
8 x		2 · 2.5 · 3 · 4 · 5 · 6 · 8 · 10
8 x		T9 · T10 · T15 · T20 · T25 · T27 · T30 · T40

V5175-L, EAN 4047728**051767**
Soft foam insert, empty

Soft foam inserts



V5634, EAN 4047728056366
Hammer, pliers and screwdriver set

40

2K

V1000
3/3+



X	Design	Size mm
1 x		-
4 x		0.6x3 · 0.8x4 · 1.0x5.5 · 1.2x6.5
3 x		PH0 · PH1 · PH2
1 x		160 mm
1 x		200 mm
1 x		250 mm
1 x		3000 mm

X	Design	Size mm
1 x		300 mm
1 x		280 mm
1 x		150 mm
1 x		150 mm
1 x		150 mm
1 x		150 mm
1 x		150 mm
1 x		120 mm
1 x		120 mm
1 x		0.05-1.00 mm

V5634-L, EAN 4047728056359
Soft foam insert, empty



V5636, EAN 4047728055970
Pliers and hammer set

25

2K

V1000
3/3+



X	Design	Size mm
1 x		250 mm
1 x		140 mm
1 x		140 mm
1 x		180 mm
1 x		180 mm
1 x		180 mm
1 x		180 mm
1 x		180 mm
1 x		350 mm

X	Design	Size mm
1 x		320 mm
1 x		200 mm
1 x		160 mm
1 x		340 mm
1 x		265 mm
1 x		-
1 x		-

V5636-L, EAN 4047728055963
Soft foam insert, empty



V5111, EAN 4047728051118
Screwdriver and pliers set

55

2K

V1000
3/3+



X	Design	Size mm
1 x		1.5 - 10
1 x		T10 - T50
1 x		200 mm
1 x		250 mm
1 x		0.05-1.00 mm
1 x		120 mm
1 x		150 mm
1 x		150 mm

X	Design	Size mm
1 x		150 mm
1 x		150 mm
1 x		150 mm
1 x		150 mm
1 x		160 mm
1 x		300 mm
4 x		0.6x3 · 0.8x4 · 1.0x5.5 · 1.2x6.5
3 x		PH0 · PH1 · PH2

V5111-L, EAN 4047728051125
Soft foam insert, empty



V5635, EAN 4047728**055956**
Pliers set for VW and AUDI



X	Design	Size mm
1 x		250 mm
1 x		160 mm
1 x		200 mm
1 x		180 mm
1 x		180 mm

X	Design	Size mm
1 x		180 mm
1 x		180 mm
1 x		250 mm
1 x		180 mm

V5635-L, EAN 4047728**055925**
Soft foam insert, empty



V5637, EAN 4047728**055994**
Pliers, hammer and chisel set



X	Design	Size mm
1 x		300 mm
1 x		280 mm
1 x		250 mm
1 x		160 mm
1 x		180 mm
1 x		180 mm
1 x		180 mm
1 x		180 mm
1 x		180 mm

X	Design	Size mm
1 x		150 mm
1 x		150 mm
1 x		150 mm
1 x		150 mm
1 x		150 mm
1 x		150 mm
1 x		150 mm
1 x		150 mm
1 x		120 mm
1 x		3000 mm
1 x		0.05-1.00 mm
1 x		265 mm

V5637-L, EAN 4047728**055987**
Soft foam insert, empty



Soft foam inserts



V4511, EAN 4047728**045117**

Hammer, chisel, drift pin set for VW and AUDI

37

2K

V1000
3/3+



X	Design	Size mm
1 x		150 mm
1 x		120 mm
1 x		150 mm
1 x		150 mm
1 x		150 mm
1 x		150 mm
1 x		150 mm
1 x		265 mm
1 x		280 mm
1 x		700 mm

X	Design	Size mm
1 x		320 mm
1 x		0.05-1.00 mm
1 x		3000 mm
1 x		-
1 x		110 mm
1 x		-
1 x		10x11
1 x		-

V4510, EAN 4047728**045100**

Soft foam insert, empty



V4755, EAN 4047728**047555**

Specialty tools for wheels / tyres

16

2K

V1000
3/3+



X	■	Design	Size mm
1 x	-		128 mm
1 x	-		12.5 1/2 186.8 mm
1 x	-		-
1 x	-		250 mm
1 x	-		500 mm
1 x	-		12.5 1/2 540 mm
1 x	-		500 mm
1 x	-		500 mm

X	■	Design	Size mm
1 x	-		500 mm
1 x	-		500 mm
1 x	12.5 1/2		78 mm
1 x	-		15
1 x	-		17
1 x	-		19
1 x	-		21
1 x	-		22

V4754, EAN 4047728**047548**

Soft foam insert, empty



V6821, EAN 4047728**068222**

Socket set



NEW

165

2K

V1000 XD
6/3+
3/3+ V1000 3/3+ V1000



X	■		Design	Size mm
1 x	10	3/8	125 1/2	36 mm
12 x	10	3/8		E20 · E18 · E16 · E14 · E12 · E11 · E10 · E8 · E7 · E6 · E5 · E4
1 x	-	10	3/8	-
1 x	-	10	3/8	237 mm
1 x	-	10	3/8	198 mm
1 x	10	3/8		-
12 x	6.3	1/4		-

X	■		Design	Size mm
10 x	6.3	1/4		13 · 12 · 11 · 10 · 9 · 8 · 7 · 6 · 5 · 4
7 x	6.3	1/4		E11 · E10 · E8 · E7 · E6 · E5 · E4
6 x	6.3	1/4		T30H · T27H · T25H · T15H · T10H · T9H
1 x	6.3	1/4	10	26 mm
1 x	10	3/8	6.3	27 mm
1 x	-	6.3	1/4	176 mm
1 x	-	6.3	1/4	-
1 x	-	6.3	1/4	150 mm
1 x	-	6.3	1/4	29 mm
1 x	8	3/8	10	30 mm

V6821-L, EAN 4047728**068055**

Soft foam insert, empty



V6822, EAN 4047728**068284**

Socket set



NEW

65

2K

V1000 XD
6/3+
3/3+ V1000 3/3+ V1000



X	■		Design	Size mm
1 x	20	3/4	125 1/2	50 mm
1 x	125	1/2	20	46 mm
1 x	125	1/2	10	36 mm
11 x	125	1/2		22 · 19 · 18 · 17 · 16 · 15 · 14 · 13 · 12 · 11 · 10
6 x	125	1/2		E24 · E20 · E18 · E22 · E16 · E14
1 x	-	125	1/2	288 mm
1 x	-	125	1/2	-
1 x	-	125	1/2	250 mm

X	■		Design	Size mm
12 x	6.3	1/4		-
17 x	125	1/2		10 · 11 · 12 · 13 · 14 · 15 · 16 · 17 · 18 · 19 · 20 · 21 · 22 · 24 · 27 · 30 · 32
2 x	125	1/2		16 · 21
1 x	-	125	1/2	250 mm
1 x	125	1/2	125	250 mm
1 x	125	1/2	125	125 mm
1 x	125	1/2	125	75 mm
1 x	-	125	1/2	250 mm

V6822-L, EAN 4047728**068062**

Soft foam insert, empty



V6809, EAN 4047728**068307**

Screwdriver socket set

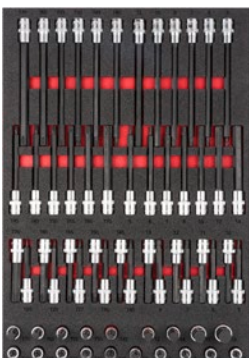

NEW

62

2K

V1000 XD
6/3+
3/3+ V1000 3/3+ V1000



X	■		Design	Size mm
10 x	125	1/2		T20 · T25 · T27 · T30 · T40 · T45 · T50 · T55 · T60 · T70
10 x	125	1/2		T20 · T25 · T27 · T30 · T40 · T45 · T50 · T55 · T60 · T70
6 x	125	1/2		T40 · T45 · T50 · T55 · T60 · T70

X	■		Design	Size mm
6 x	125	1/2		T40 · T45 · T50 · T55 · T60 · T70
9 x	125	1/2		5 · 6 · 7 · 8 · 10 · 12 · 14 · 17 · 19
8 x	125	1/2		5 · 6 · 7 · 8 · 10 · 11 · 12 · 13
7 x	125	1/2		5 · 6 · 7 · 8 · 10 · 12 · 14
6 x	125	1/2		5 · 6 · 7 · 8 · 10 · 12

V6809-L, EAN 4047728**068093**

Soft foam insert, empty



Soft foam inserts



V6810, EAN 4047728**068413**
Screwdriver socket set

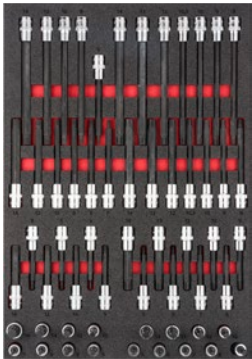

NEW

58

2K

V1000 XD
6/3+
3/3+ V1000 | 3/3+ V1000

X			Design	Size mm
8 x	12.9	1/2		M5 · M6 · M8 · M9 · M10 · M12 · M14 · M16
7 x	12.9	1/2		M5 · M6 · M8 · M9 · M10 · M12 · M14
7 x	12.9	1/2		M5 · M6 · M8 · M9 · M10 · M12 · M14
4 x	12.9	1/2		M8 · M10 · M12 · M14

X			Design	Size mm
9 x	12.9	1/2		M5 · M6 · M7 · M8 · M9 · M10 · M12 · M13 · M14
9 x	12.9	1/2		M5 · M6 · M7 · M8 · M9 · M10 · M12 · M13 · M14
7 x	12.9	1/2		M8 · M9 · M10 · M10.3 · M12 · M13 · M14
7 x	12.9	1/2		M8 · M9 · M10 · M10.3 · M12 · M13 · M14



V6810-L, EAN 4047728**068109**
Soft foam insert, empty



V6807, EAN 4047728**068277**
Ratcheting combination wrench set



NEW

33

2K

V1000 XD
6/3+
3/3+ V1000 | 3/3+ V1000

X			Design	Size mm
18 x				8 · 9 · 10 · 11 · 12 · 13 · 14 · 15 · 16 · 17 · 18 · 19 · 21 · 22 · 24 · 27 · 30 · 32

X			Design	Size mm
22 x				6 · 7 · 8 · 9 · 10 · 11 · 12 · 13 · 14 · 15 · 16 · 17 · 18 · 19 · 20 · 21 · 22 · 24 · 27 · 30 · 32 · 36



V6807-L, EAN 4047728**068079**
Soft foam insert, empty



V6808, EAN 4047728**068291**
Double box-end and open-end wrench set



NEW

24

2K

V1000 XD
6/3+
3/3+ V1000 | 3/3+ V1000

X			Design	Size mm
1 x				6x7 · 8x9 · 10x11 · 12x13 · 19x15 · 16x17 · 18x19 · 20x22 · 21x23 · 24x27 · 25x28 · 30x32

X			Design	Size mm
1 x				6x7 · 8x9 · 10x11 · 12x13 · 14x15 · 16x17 · 18x19 · 20x22 · 21x23 · 24x27 · 25x28 · 30x32



V6808-L, EAN 4047728**068086**
Soft foam insert, empty



V6813, EAN 4047728**068444**

Screwdriver set



NEW

30

2K

V1000 XD
6/3+
3/3+ 3/3+
V1000 V1000

X	Design	Size mm
6 x		0.6x3 · 0.8x4 · 1.0x5.5 · 1.2x6.5 · 1.6x8 · 1.6x10
4 x		PH0 · PH1 · PH2 · PH3
1 x		1x5.5
1 x		PH2

X	Design	Size mm
4 x		0.6x3.5 · 1.0x4.5 · 1x5.5 · 1.2x6.5
2 x		PH1 · PH2
11 x		T6 · T7 · T8 · T9 · T10 · T15 · T20 · T25 · T27 · T30 · T40
1 x		3x0.5

V6813-L, EAN 4047728**068130**

Soft foam insert, empty

V6814, EAN 4047728**068451**

Screwdriver bit set



NEW

97

2K

V1000 XD
6/3+
3/3+ 3/3+
V1000 V1000

X	Design	Size mm
1 x		260 mm
1 x		130 mm
1 x		-
1 x		300 mm
1 x		1.6 · 2 · 2.4 · 3 mm · PH00 · PH0
1 x		T10 - T50

X	Design	Size mm
1 x		1.5 - 10
1 x		200 mm
1 x		-
1 x		-

V6814-L, EAN 4047728**068147**

Soft foam insert, empty

V6815, EAN 4047728**068468**

Pliers set



NEW

23

2K

V1000 XD
6/3+
3/3+ 3/3+
V1000 V1000

X	Design	Size mm
1 x		345 mm
1 x		345 mm
1 x		335 mm
1 x		340 mm
1 x		340 mm
1 x		300 mm
1 x		290 mm

X	Design	Size mm
1 x		250 mm
1 x		200 mm
1 x		160 mm
1 x		115 mm
1 x		180 mm
1 x		-

V6815-L, EAN 4047728**068154**

Soft foam insert, empty

Soft foam inserts



V6816, EAN 4047728**068475**
Pliers set



NEW

17

2K

V1000 XD
6/3+
3/3+ 3/3+
V1000 V1000

X	Design	Size mm
1 x		16-27
1 x		11-19
1 x		-
1 x		180 mm

X	Design	Size mm
1 x		180 mm
1 x		180 mm
1 x		180 mm
1 x		-
1 x		-



V6816-L, EAN 4047728**068161**
Soft foam insert, empty



V6817, EAN 4047728**068499**
Hammer, chisel and drift pin set



NEW

51

2K

V1000 XD
6/3+
3/3+ 3/3+
V1000 V1000

X	Design	Size mm
1 x		350 mm
1 x		280 mm
1 x		280 mm
1 x		645 mm
1 x		-
1 x		-
1 x		-
1 x		-
1 x		-
1 x		150 mm
1 x		150 mm
1 x		150 mm
1 x		150 mm

X	Design	Size mm
1 x		150 mm
1 x		150 mm
1 x		150 mm
1 x		120 mm
1 x		190 mm
1 x		170 mm
1 x		185 mm
1 x		185 mm
1 x		-
1 x		-



V6817-L, EAN 4047728**068178**
Soft foam insert, empty



V6818, EAN 4047728**068482**
Scraper and lever set



NEW

41

2K

V1000 XD
6/3+
3/3+ 3/3+
V1000 V1000

X	Design	Size mm
1 x		165 mm
1 x		-
1 x		330 mm
1 x		-

X	Design	Size mm
1 x		265 mm
1 x		-
1 x		-
1 x		-



V6818-L, EAN 4047728**068185**
Soft foam insert, empty



V6811, EAN 4047728**068420**

Impact socket set



NEW

81

2K

V1000 XD
6/3+
3/3+ V1000 | 3/3+ V1000

X			Design	Size mm
4 x	20	3/4"		24 · 30 · 32 · 36
1 x	6.3	1/4"		-
	10	3/8"		-
	12.5	1/2"		-
1 x	12.5	1/2"		78 mm
1 x	12.5	1/2"		19
1 x	12.5	1/2"		17
8 x	12.5	1/2"		T30 · T40 · T45 · T50 · T55 · T60 · T70 · T80
8 x	12.5	1/2"		M5 · M6 · M8 · M10 · M12 · M14 · M16 · M18
8 x	12.5	1/2"		H5 · H6 · H8 · H10 · H12 · H14 · H17 · H19

X			Design	Size mm
13 x	12.5	1/2"		10 · 11 · 12 · 13 · 14 · 15 · 16 · 17 · 18 · 19 · 21 · 22 · 24
13 x	12.5	1/2"		10 · 11 · 12 · 13 · 14 · 15 · 16 · 17 · 18 · 19 · 21 · 22 · 24
9 x	12.5	1/2"		10 · 11 · 12 · 13 · 14 · 15 · 16 · 17 · 19
6 x	6.3	1/4"		T10 · T15 · T20 · T25 · T30 · T40
1 x	-			15
1 x	-			17
1 x	-			19
1 x	-			21
1 x	-			22

V6811-L, EAN 4047728**068116**

Soft foam insert, empty

V6812, EAN 4047728**068437**

Specialty tools for wheels / tyres



NEW

13

2K

V1000 XD
6/3+
3/3+ V1000 | 3/3+ V1000

X			Design	Size mm
1 x	-			-
1 x	-			-
1 x	-			270 mm
1 x	-			500 mm
1 x	-			-

X			Design	Size mm
1 x	-			128 mm
1 x	-			-
1 x	12.5	1/2"		118 mm
1 x	-			250 mm
1 x	12.5	1/2"		540 mm

V6812-L, EAN 4047728**068123**

Soft foam insert, empty

Soft foam inserts



V5009, EAN 4047728**050098**
2-component soft foam insert,
with empty compartment



V5018, EAN 4047728**050180**
2-component soft foam insert,
with empty compartment



V4631, EAN 4047728**046312**
Soft foam insert, without cut-out



V4632, EAN 4047728**046329**
Soft foam insert, without cut-out



V4586, EAN 4047728**045865**

Socket tool set for VIGOR 1000 XL

219

2K

V1000
4/3+

X	■	●	Design	Size mm
5 x	6.3 1/4	●		R5 · R6 · R7 · R8 · R9
3 x	6.3 1/4	●		T5 · T6 · T7
3 x	6.3 1/4	○		M5 · M6 · M8
9 x	6.3 1/4	●		T7H · T10H · T15H · T20H · T25H · T27H · T30H · T40H · T45H
6 x	8 3/8	●		T40 · T45 · T50 · T55 · T60 · T70
5 x	8 3/8	○		7 · 8 · 10 · 12 · 14
2 x	8 3/8	●		PH3 · PH4
2 x	8 3/8	●		PZ3 · PZ4
3 x	8 3/8	○		8 · 10 · 12
6 x	8 3/8	●		T40H · T45H · T50H · T55H · T60H · T70H
4 x	-	○		1.27 · 1.5 · 2 · 2.5
1 x	6.3 1/4	6.3 1/4		30 mm
1 x	10 3/8	8 3/8		28 mm
1 x	12.5 1/2	8 3/8		37 mm
1 x	6.3 1/4	6.3 1/4		110 mm
1 x	-	12.5 1/2		43.7 mm
8 x	12.5 1/2	●		T27 · T30 · T40 · T45 · T50 · T55 · T60 · T70
8 x	12.5 1/2	●		T20 · T25 · T27 · T30 · T40 · T45 · T50 · T55
8 x	12.5 1/2	○		5 · 6 · 7 · 8 · 10 · 12 · 14 · 17
8 x	12.5 1/2	○		5 · 6 · 7 · 8 · 10 · 11 · 12 · 13
7 x	12.5 1/2	○		M5 · M6 · M8 · M9 · M10 · M14 · M16
7 x	12.5 1/2	○		M5 · M6 · M8 · M9 · M10 · M12 · M14
4 x	6.3 1/4	○		3 · 4 · 5 · 6
4 x	6.3 1/4	○		0.8x4-1x5.5 · 1.2x6.5-1.2x7
3 x	6.3 1/4	●		PH0 · PH1 · PH2

X	■	●	Design	Size mm
3 x	6.3 1/4	●		PZ0 · PZ1 · PZ2
6 x	6.3 1/4	●		T9 · T10 · T15 · T20 · T25 · T30
7 x	6.3 1/4	●		T9H · T10H · T15H · T15H · T20H · T27H · T30H
6 x	10 3/8	●		E10 · E11 · E12 · E14 · E16 · E18
6 x	10 3/8	○		10 · 11 · 12 · 13 · 14 · 15
10 x	10 3/8	○		10 · 11 · 12 · 13 · 14 · 15 · 16 · 17 · 18 · 19
17 x	12.5 1/2	○		10 · 11 · 12 · 13 · 14 · 15 · 16 · 17 · 18 · 19 · 20 · 21 · 22 · 24 · 27 · 30 · 32
5 x	12.5 1/2	○		16 · 17 · 18 · 19 · 22
2 x	12.5 1/2	●		E20 · E22
13 x	6.3 1/4	○		4 · 4.5 · 5 · 5.5 · 6 · 7 · 8 · 9 · 10 · 11 · 12 · 13 · 14
7 x	6.3 1/4	○		4 · 5 · 6 · 7 · 8 · 9 · 10
5 x	6.3 1/4	●		E4 · E5 · E6 · E7 · E8
1 x	6.3 1/4	●		T27
1 x	-	6.3 1/4		150 mm
1 x	-	6.3 1/4		150 mm
1 x	-	10 3/8		198 mm
1 x	-	12.5 1/2		250 mm
1 x	6.3 1/4	6.3 1/4		40 mm
1 x	10 3/8	10 3/8		50 mm
1 x	12.5 1/2	12.5 1/2		75 mm
1 x	6.3 1/4	6.3 1/4		50 mm
1 x	6.3 1/4	6.3 1/4		100 mm
1 x	10 3/8	10 3/8		125 mm
1 x	12.5 1/2	12.5 1/2		125 mm
1 x	12.5 1/2	12.5 1/2		250 mm
1 x	10 3/8	○		18
2 x	12.5 1/2	○		16 · 21

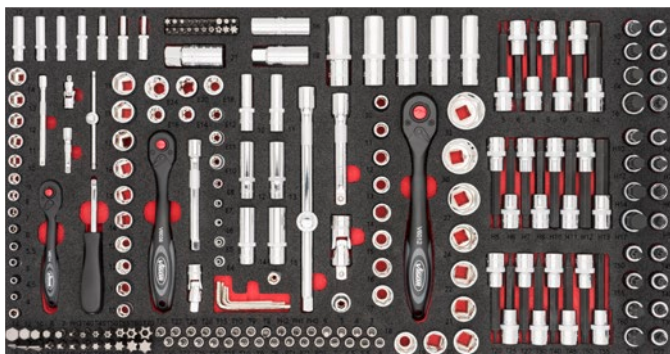

V4521, EAN 4047728**045216**

Soft foam insert, empty

Soft foam inserts



V5170, EAN 4047728051712
Screwdriver set

60

2K

V1000
4/3+

X	Design	Size mm
1 x		T10 - T50
1 x		1.5 - 10
11 x		T10 · T15 · T20 · T25 · T27 · T30 · T40 · T6 · T7 · T8 · T9
6 x		1.6x8 · 1.6x10 · 0.6x3 · 0.8x4 · 1.0x5.5 · 1.2x6.5
4 x		PH3 · PH0 · PH1 · PH2
1 x		3x0.5

X	Design	Size mm
1 x		1x5.5
1 x		PH2
1 x		1.6 · 2 · 2.4 · 3 mm PH00 · PH0
6 x		6 · 7 · 8 · 10 · 12 · 13
4 x		0.6x3.5 · 1.0x4.5 · 1x5.5 · 1.2x6.5
3 x		PH1 · PH2 · PH3



V5170-L, EAN 4047728051729
Soft foam insert, empty



V5638, EAN 4047728056410
Pliers, hammer and chisel set

38

2K

V1000
4/3+

X	Design	Size mm
1 x		250 mm
1 x		335 mm
1 x		340 mm
1 x		200 mm
1 x		180 mm
1 x		160 mm
1 x		180 mm
1 x		180 mm
1 x		140 mm
1 x		140 mm
1 x		180 mm
1 x		180 mm
1 x		150 mm
1 x		150 mm

X	Design	Size mm
1 x		150 mm
1 x		150 mm
1 x		150 mm
1 x		150 mm
1 x		150 mm
1 x		150 mm
1 x		150 mm
1 x		150 mm
1 x		120 mm
1 x		265 mm
1 x		280 mm
1 x		-
1 x		-
1 x		280 mm
1 x		360 mm
1 x		-



V5638-L, EAN 4047728056007
Soft foam insert, empty



V6650, EAN 4047728067454

Combination, double box-end wrench set for VIGOR 1000 XL

58

2K

V1000
4/3+

X	Design	Size mm
12 x		6x7 · 8x9 · 10x11 · 12x13 · 14x15 · 16x17 · 18x19 · 20x22 · 21x23 · 24x27 · 25x28 · 30x32
22 x		6 · 7 · 8 · 9 · 10 · 11 · 12 · 13 · 14 · 15 · 16 · 17 · 18 · 19 · 20 · 21 · 22 · 24 · 27 · 30 · 32 · 36

X	Design	Size mm
12 x		8 · 9 · 10 · 11 · 12 · 13 · 14 · 15 · 16 · 17 · 18 · 19
12 x		6x7 · 8x9 · 10x11 · 12x13 · 14x15 · 16x17 · 18x19 · 20x22 · 21x23 · 24x27 · 25x28 · 30x32

NEW



V5170-L, EAN 4047728051729

Soft foam insert, empty



Soft foam inserts

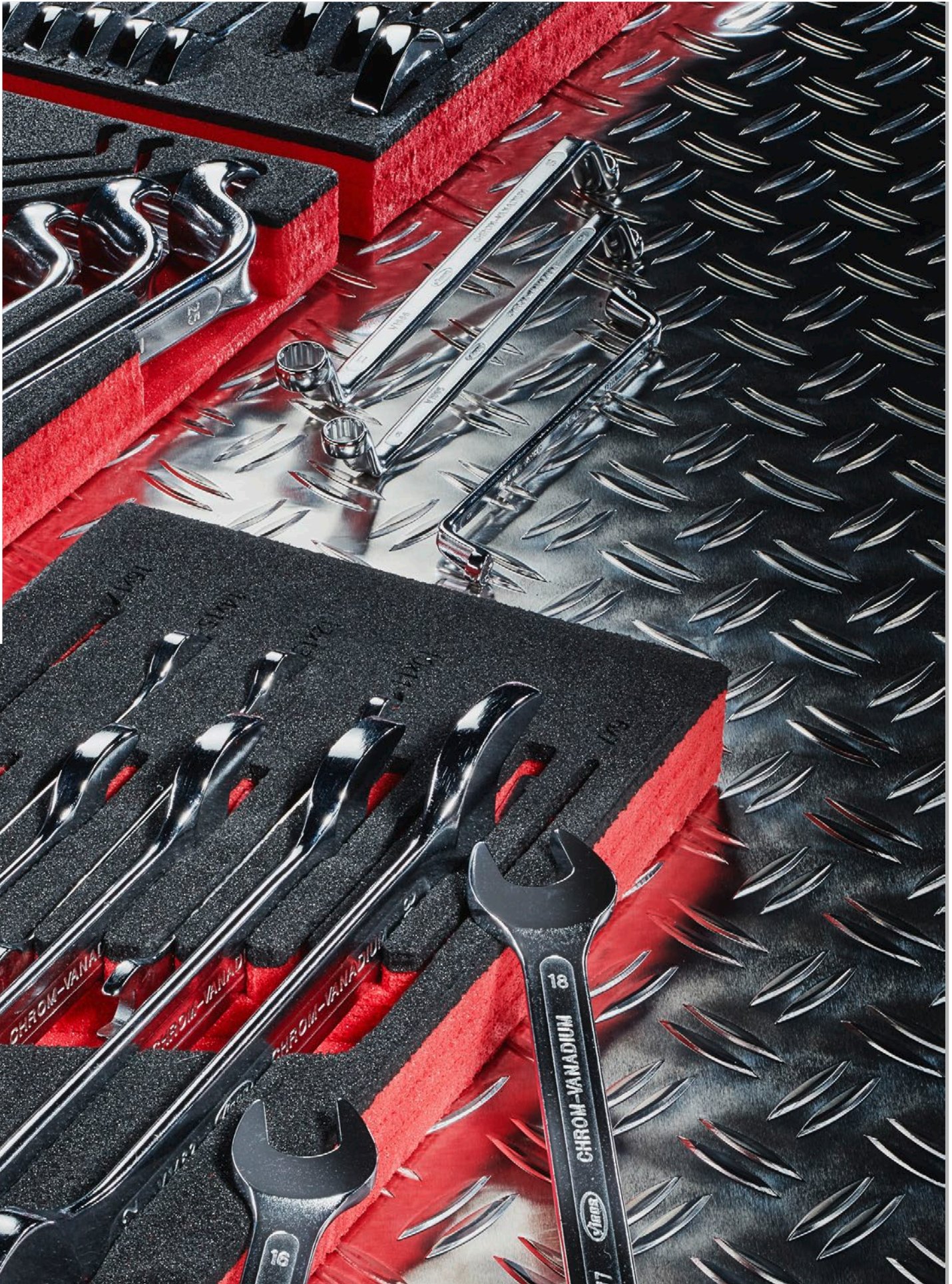



Hand tools

Sockets	132–181
Universal tool cases	182–183
Wrenches	184–194
Screwdrivers and bits	195–203
Pliers	204–215
VDE tools	216–219
Impact and releasing tools, scrapers	220–226
Various hand tools	227
Cutting and sawing	228–235



V5202, EAN 4047728**068987**

Socket set, super flat

6.3 1/4"



NEW

**Incl. bit holder
and bits!**



VIGOR No.	Designation	Design		Size mm	EAN 4047728+
V5202-1	Reversible ratchet		6.3 1/4"	-	069366
V5202-2	Square adapter		6.3 1/4"	-	069373
V5202-4	Socket, super flat			4	069380
V5202-4.5	Socket, super flat			4.5	069397
V5202-5	Socket, super flat			5	069403
V5202-5.5	Socket, super flat			5.5	069410
V5202-6	Socket, super flat			6	069427
V5202-7	Socket, super flat			7	069434
V5202-8	Socket, super flat			8	069441
V5202-9	Socket, super flat			9	069458
V5202-10	Socket, super flat			10	069465
V5202-11	Socket, super flat			11	069472
V5202-12	Socket, super flat			12	069489
V5202-13	Socket, super flat			13	069496
V5202-14	Socket, super flat			14	069502

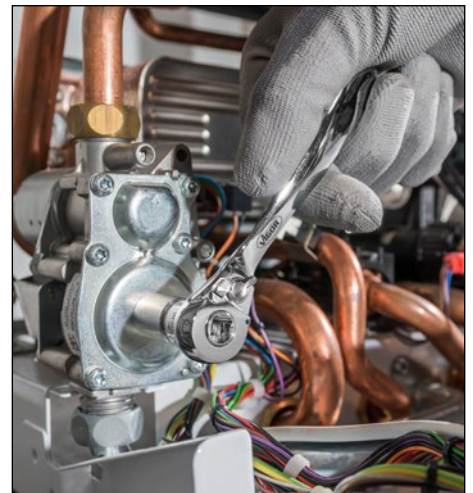

V3734N, EAN 4047728**056427**











Socket set



23

NEW

Single parts from page 135

X	■	□	Design	Size mm
12 x	6.3 1/4"			4 · 4.5 · 5 · 5.5 · 6 · 7 · 8 · 9 · 10 · 11 · 12 · 13
1 x	6.3 1/4"	6.3 1/4"		100 mm
1 x	6.3 1/4"	6.3 1/4"		25 mm
1 x	-	6.3 1/4"		150 mm
2 x	6.3 1/4"			PH1 · PH2
2 x	6.3 1/4"			PZ1 · PZ2
4 x	6.3 1/4"			T15 · T20 · T25 · T30

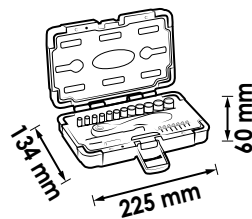

V2414N, EAN 4047728**056434**























Socket set



46

NEW

Single parts from page 135

X	■	□	Design	Size mm
13 x	6.3 1/4"			4 · 4.5 · 5 · 5.5 · 6 · 7 · 8 · 9 · 10 · 11 · 12 · 13 · 14
3 x	6.3 1/4"			0.8x4 · 1x5.5 · 1.2x7
6 x	6.3 1/4"			3 · 4 · 5 · 6 · 7 · 8
3 x	6.3 1/4"			PH1 · PH2 · PH3
3 x	6.3 1/4"			PZ1 · PZ2 · PZ3
6 x	6.3 1/4"			T10 · T15 · T20 · T25 · T30 · T40
4 x	-			1.27 · 1.5 · 2 · 2.5
1 x	10 3/8"	6.3 1/4"		27 mm
1 x	6.3 1/4"	6.3 1/4"		110 mm
1 x	6.3 1/4"	6.3 1/4"		50 mm
1 x	6.3 1/4"	6.3 1/4"		100 mm
1 x	6.3 1/4"	6.3 1/4"		145 mm
1 x	6.3 1/4"	6.3 1/4"		40 mm
1 x	-	6.3 1/4"		150 mm
1 x	-	6.3 1/4"		150 mm

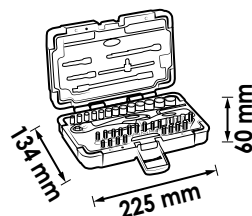

V4217, EAN 4047728**042178**

Socket set with multi-purpose profile

40



Single parts from page 137

X	■	●	Design	Size mm
7 x	6.3 1/4"	●		T10 · T15 · T20 · T25 · T27 · T30 · T40
5 x	6.3 1/4"	●		M4 · M5 · M6 · M8 · M10
6 x	6.3 1/4"	●		3 · 4 · 5 · 6 · 7 · 8
2 x	6.3 1/4"	●		PH1 · PH2
2 x	6.3 1/4"	●		PZ1 · PZ2
1 x	6.3 1/4"	●		25 mm
13 x	6.3 1/4"	●		4 · 4.5 · 5 · 5.5 · 6 · 7 · 8 · 9 · 10 · 11 · 12 · 13 · 14
1 x	-	6.3 1/4"		150 mm
1 x	6.3 1/4"	6.3 1/4"		40 mm
1 x	6.3 1/4"	6.3 1/4"		100 mm
1 x	-	6.3 1/4"		150 mm



V1897, EAN 4047728**018975**

Socket set with multi-purpose profile

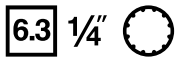

Multi-purpose screw profiles

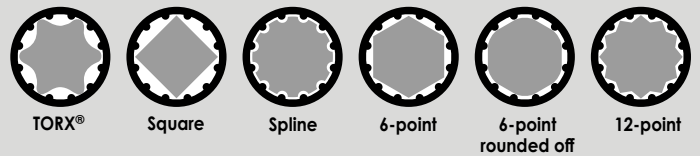

12



All sockets suitable for 6 different profiles!

Single parts see page 140

X	■	●	Design	Size mm
12 x	6.3 1/4"	●		4 · 5 · 5.5 · 6 · 7 · 8 · 9 · 10 · 11 · 12 · 13 · 14



V6014, EAN 4047728055833

Fine-tooth reversible ratchet

- Offset design
- Plastic coating
- Quick-release press-button
- 72 teeth
- 5° opening angle

6.3 1/4"

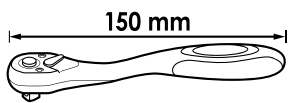

6.3 1/4"

V6014-REP, EAN 4047728056519

Repair set

- Repair set for fine-tooth reversible ratchet V6014



V5436, EAN 4047728054362

360° rotary handle reversible ratchet

- Use in areas with restricted access
- Sliding square for clockwise/anti-clockwise operation
- Standard operation possible through locking function
- Only clockwise operation
- 72 teeth
- 5° opening angle

6.3 1/4"



Actuator mechanism in the 360° rotary handle

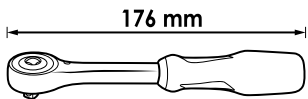

6.3 1/4"

Loosening and tightening of screw connections only in locked mode!



V6614, EAN 4047728066440

Telescopic reversible ratchet with hinge joint

- Telescopic range 175–225 mm
- 180° swivel head with locking mechanism
- Quick-release press-button
- 72 teeth
- 5° opening angle

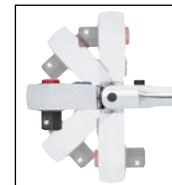
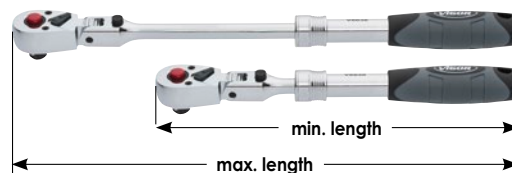

Latches in 5 positions



Can be adjusted to various fixing points
Example on V6638

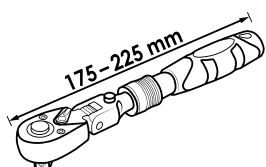

NEW

V6614-REP, EAN 4047728067980

Repair set

- Repair set for telescopic reversible ratchet V6614



V4944, EAN 4047728**049443**

6.3 1/4"

Fine-tooth reversible ratchet, long design

- Robust and service-friendly
- Closed system
- Easy to clean
- 72 teeth
- 5° opening angle
- DIN 3122, ISO 3315

Substantially higher than the load requirements of DIN 3122!

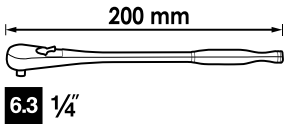

Closed system



Sturdy solid steel design



6.3 1/4"

V4944-S, EAN 4047728**055345**

Fine-tooth reversible ratchet, standard

- Robust and service-friendly
- Closed system
- Easy to clean
- 72 teeth
- 5° opening angle

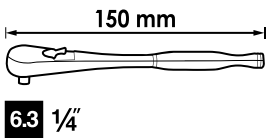

V4944-REP, EAN 4047728**049474**

Repair set

- Repair set for fine-tooth reversible ratchets V4944 · V4944-S · V4944-XS



V4944-XS, EAN 4047728**069557**

6.3 1/4"

Fine-tooth reversible ratchet, extra-short design

- Robust and service-friendly
- Closed system
- Easy to clean
- 72 teeth
- 5° opening angle

NEW

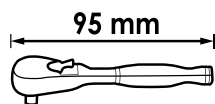

Sockets



Finger ratchet

- 72 teeth
- 5° opening angle

6.3 1/4" **6.3** 1/4"



VIGOR No.	mm	EAN 4047728+
V2941	29	029414

Spin type speeder

6.3 1/4"



VIGOR No.	mm	EAN 4047728+
V2458N	150	058179

Sliding T-handle

6.3 1/4" **6.3** 1/4"



VIGOR No.	mm	EAN 4047728+
V2453N	110	058124

Universal joint

6.3 1/4" **6.3** 1/4"



VIGOR No.	mm	EAN 4047728+
V2454N	40	058131

Flexible extension

6.3 1/4" **6.3** 1/4"



VIGOR No.	mm	EAN 4047728+
V2457N	145	058162



Wobble extension

- Operation of screw connections in confined spaces and working in areas with restricted access
- Spherical, tapered outside square

6.3 1/4" **6.3** 1/4" 

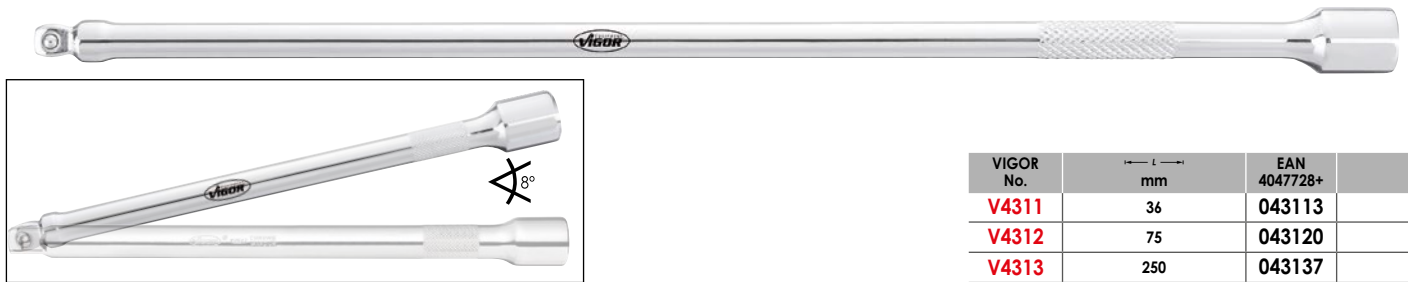

VIGOR No.	mm	EAN 4047728+
V4311	36	043113
V4312	75	043120
V4313	250	043137

Extension

6.3 1/4" **6.3** 1/4"



VIGOR No.	mm	EAN 4047728+
V2455N	50	058148
V2456N	100	058155

Adapter

6.3 1/4" **10** 3/8"



VIGOR No.	mm	EAN 4047728+
V2014	26	020145

Adapter

6.3 1/4" 6.3 1/4"



VIGOR No.	mm	EAN 4047728+
V2452N	30	058117

Bit adapter

6.3 1/4" 6.3 1/4"



VIGOR No.	mm	EAN 4047728+
V3651N	25	058872

Socket

6.3 1/4"



VIGOR No.	Size mm	mm	EAN 4047728+
V2413N	4	25	057738
V2415N	4,5	25	057745
V2416N	5	25	057752
V2417N	5,5	25	057769
V2418N	6	25	057776
V2419N	7	25	057783
V2420N	8	25	057790

VIGOR No.	Size mm	mm	EAN 4047728+
V2421N	9	25	057806
V2422N	10	25	057813
V2423N	11	25	057820
V2424N	12	25	057837
V2425N	13	25	057844
V2426N	14	25	057851



Socket, long



VIGOR No.	Size mm	mm	EAN 4047728+
V2533N	4	50	058193
V2534N	5	50	058209
V2535N	6	50	058216
V2536N	7	50	058223
V2537N	8	50	058230
V2538N	9	50	058247
V2539N	10	50	058254
V2699N	11	50	058735
V2700N	12	50	058742
V2701N	13	50	058759

TORX® Socket



VIGOR No.	Size mm	mm	EAN 4047728+
V2185	E4	24,8	021852
V2186	E5	24,8	021869
V2187	E6	24,8	021876
V2188	E7	24,8	021883
V2189	E8	24,8	021890
V2722	E10	24,8	027229
V2723	E11	24,8	027236

Socket with multi-purpose profile



VIGOR No.	Size mm	mm	EAN 4047728+
V1976	4	25	019767
V1977	5	25	019774
V1979	6	25	019798
V1980	7	25	019804
V1981	8	25	019811
V1982	9	25	019828

VIGOR No.	Size mm	mm	EAN 4047728+
V1983	10	25	019835
V1984	11	25	019842
V1985	12	25	019859
V1986	13	25	019866
V1987	14	25	019873

Screwdriver socket



VIGOR No.	Size mm	mm	EAN 4047728+
V2595N	T9	38	058599
V2442N	T10	38	058018
V2443N	T15	38	058025
V2444N	T20	38	058032
V2445N	T25	38	058049
V2130N	T27	38	057042
V2446N	T30	38	058056
V2447N	T40	38	058063

Screwdriver socket



VIGOR No.	Size mm	mm	EAN 4047728+
V2596N	T9H	38	058605
V2136	T10H	37	021364
V2138	T15H	37	021388
V2139	T20H	37	021395
V2140	T25H	37	021401
V2141	T27H	37	021418
V2142	T30H	37	021425

Screwdriver socket



VIGOR No.	Size mm	mm	EAN 4047728+
V2593N	PH0	38	058575
V2436N	PH1	38	057950
V2437N	PH2	38	057967
V2438N	PH3	38	057974

Screwdriver socket



VIGOR No.	Size mm	mm	EAN 4047728+
V2594N	PZ0	38	058582
V2439N	PZ1	38	057981
V2440N	PZ2	38	057998
V2441N	PZ3	38	058001

Screwdriver socket

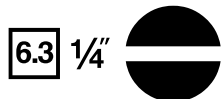

VIGOR No.	mm	mm	EAN 4047728+
V2427N	0,8x4	38	057868
V2428N	1x5,5	38	057875
V2597N	1,2x6,5	38	058612
V2429N	1,2x7	38	057882

Screwdriver socket



VIGOR No.	Size mm	mm	EAN 4047728+
V2430N	3	38	057899
V2431N	4	38	057905
V2432N	5	38	057912
V2433N	6	38	057929
V2434N	7	38	057936
V2435N	8	38	057943



V6202, EAN 4047728**062022**

Socket set, super flat

- Flat insert profile – Direct attachment to the nut/screw connection
- Robust solid steel reversible ratchet
- Right and left-hand operation
- Ergonomic handle
- Sockets without chamfered edge
- Super short sockets make it possible to work in very tight spaces
- Sockets with outside hexagon size 17 mm for operation with box-end wrench or open-end wrench



10 3/8"

18

Super flat



Your problem solver for flat screw connections and tight spaces!

Comparison

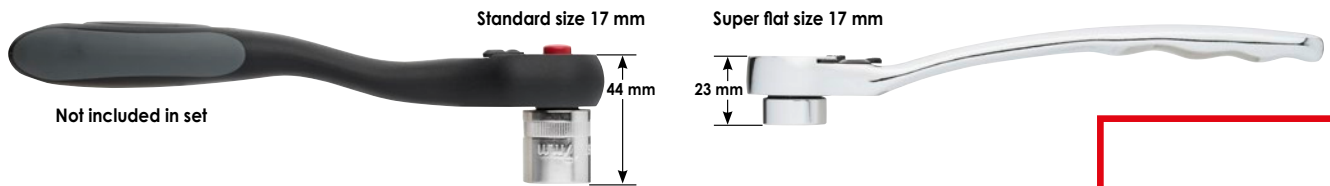

VIGOR No.			Designation	Size mm	mm	EAN 4047728+
V6202-1	-		Reversible ratchet	-	200	062640
V6202-2			Square adapter	-	30	062657
V6202-3			Universal joint	-	60	062664
V6202-4			Extension, 75 mm	-	75	062671
V6202-5			Extension, 150 mm	-	150	062688
V6202-8			Socket, super flat	8	-	062053
V6202-9			Socket, super flat	9	-	062077
V6202-10			Socket, super flat	10	-	062091
V6202-11			Socket, super flat	11	-	062107
V6202-12			Socket, super flat	12	-	062510
V6202-13			Socket, super flat	13	-	062534
V6202-14			Socket, super flat	14	-	062572
V6202-15			Socket, super flat	15	-	062589
V6202-16			Socket, super flat	16	-	062596
V6202-17			Socket, super flat	17	-	062602
V6202-19			Socket, super flat	19	-	062220
V6202-21			Socket, super flat	21	-	062619
V6202-22			Socket, super flat	22	-	062626

**Without chamfered edge
For low screw head heights!**

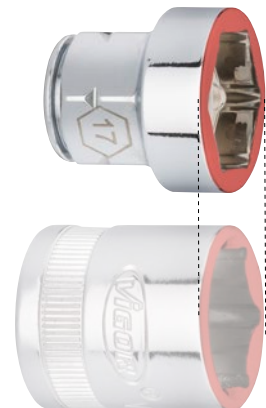

Sockets



V2305N, EAN 4047728056441

Socket set

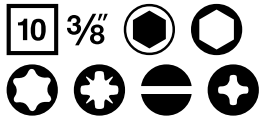

61

NEW

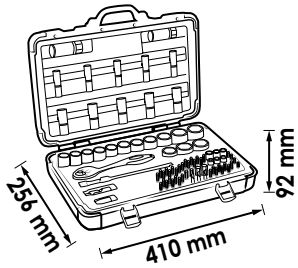

Single parts from page 145

X	■	●	Design	Size mm
18 x	10 3/8	●		6 · 7 · 8 · 9 · 10 · 11 · 12 · 13 · 14 · 15 · 16 · 17 · 18 · 19 · 20 · 21 · 22 · 24
10 x	10 3/8	●		8 · 9 · 10 · 11 · 12 · 13 · 14 · 15 · 17 · 19
2 x	10 3/8	●		16 · 21
7 x	10 3/8	○		3 · 4 · 5 · 6 · 7 · 8 · 10
3 x	10 3/8	●		0.8x5.5 · 1x7 · 1.2x8
3 x	10 3/8	+		PH1 · PH2 · PH3
3 x	10 3/8	+		PZ1 · PZ2 · PZ3

X	■	●	Design	Size mm
9 x	10 3/8	●		T15 · T20 · T25 · T27 · T30 · T40 · T45 · T50 · T55
1 x	10 3/8	⊗ 3/8		28 mm
1 x	12 1/2	10 3/8		250 mm
1 x	10 3/8	10 3/8		75 mm
1 x	10 3/8	10 3/8		250 mm
1 x	10 3/8	10 3/8		50 mm
1 x	-	10 3/8		198 mm



V6017, EAN 4047728**064361**

TORX® screwdriver socket set

- Phosphatized blades
- Chrome-vanadium steel
- Knurling

10 3/8



32

NEW

Single parts from page 148

X	■	○	Design	Size mm
10 x	10 3/8			T20 · T25 · T27 · T30 · T40 · T45 · T50 · T55 · T60 · T70
10 x	10 3/8			T20 · T25 · T27 · T30 · T40 · T45 · T50 · T55 · T60 · T70
6 x	10 3/8			T40 · T45 · T50 · T55 · T60 · T70
6 x	10 3/8			T40 · T45 · T50 · T55 · T60 · T70



V6018, EAN 4047728**065894**

Screwdriver socket set for screws with internal serration (XZN)

- Phosphatized blades
- Chrome-vanadium steel
- Knurling

10 3/8



26

NEW

Single parts from page 149

X	■	○	Design	Size mm
8 x	10 3/8			M5 · M6 · M8 · M9 · M10 · M12 · M14 · M16
7 x	10 3/8			M5 · M6 · M8 · M9 · M10 · M12 · M14
7 x	10 3/8			M5 · M6 · M8 · M9 · M10 · M12 · M14
4 x	10 3/8			M8 · M10 · M12 · M14



V6019, EAN 4047728**065900**

Screwdriver socket set for inside hexagon screws

- Phosphatized blades
- Chrome-vanadium steel
- Knurling

10 3/8



30

NEW

Single parts from page 151

X	■	○	Design	Size mm
9 x	10 3/8			5 · 6 · 7 · 8 · 10 · 12 · 14 · 17 · 19
8 x	10 3/8			5 · 6 · 7 · 8 · 10 · 11 · 12 · 13
7 x	10 3/8			5 · 7 · 8 · 10 · 12 · 14 · 6
6 x	10 3/8			5 · 7 · 8 · 10 · 12 · 6



Sockets



V6038, EAN 4047728055840

Fine-tooth reversible ratchet

- Offset design
- Plastic coating
- Quick-release press-button
- 72 teeth
- 5° opening angle
- DIN 3122, ISO 3315



10 3/8"

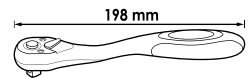

V6638, EAN 4047728066457

Telescopic reversible ratchet with hinge joint

- Telescopic range 250–350 mm
- 180° swivel head with locking mechanism
- Quick-release press-button
- 72 teeth
- 5° opening angle

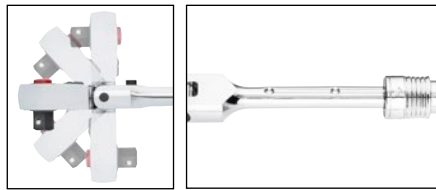

Latches in 5 positions
Can be adjusted to various fixing points

NEW 10 3/8"

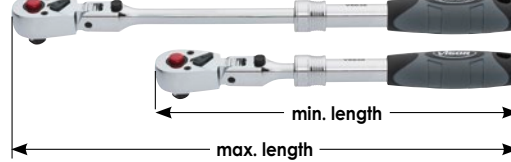

V6038-REP, EAN 4047728056526

Repair set

- Repair set for fine-tooth reversible ratchet V6038 · V6638



V6008, EAN 4047728060080

360° rotary handle reversible ratchet

- Use in areas with restricted access
- Sliding square for clockwise/anti-clockwise operation
- Standard operation possible through locking function
- Only clockwise operation
- 72 teeth
- 5° opening angle

Loosening and tightening of screw connections only in locked mode!

Actuator mechanism in the 360° rotary handle

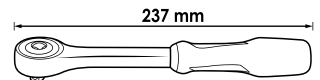

10 3/8"

V4945, EAN 4047728049450

Fine-tooth reversible ratchet, long design

- Robust and service-friendly
- Closed system
- Easy to clean
- 72 teeth
- 5° opening angle

Substantially higher than the load requirements of DIN 3122!

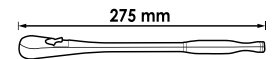

10 3/8"

Closed system



Sturdy solid steel design



V4945-S, EAN 4047728055352

Fine-tooth reversible ratchet, standard

- Robust and service-friendly
- Closed system
- Easy to clean
- 72 teeth
- 5° opening angle



10 3/8"

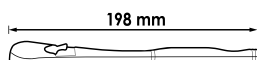

10 3/8"

V4945-REP, EAN 4047728049481

Repair set

- Repair set for fine-tooth reversible ratchets V4945 · V4945-S



Socket

10 3/8" 



VIGOR No.	Size mm	Length mm	EAN 4047728+
V2278N	6	28	057219
V2277N	7	28	056908
V2276N	8	28	056892
V2275N	9	28	056885
V2274N	10	28	056878
V2273N	11	28	056861
V2272N	12	28	056854
V2271N	13	28	056847
V2270N	14	28	056830

VIGOR No.	Size mm	Length mm	EAN 4047728+
V2269N	15	28	057141
V2268N	16	28	057134
V2267N	17	30	057127
V2266N	18	30	057110
V2265N	19	30	057103
V2264N	20	30	057097
V2263N	21	30	057080
V2262N	22	30	057073
V2261N	24	30	057066

Socket, long

10 3/8" 



VIGOR No.	Size mm	Length mm	EAN 4047728+
V2016N	8	63	056922
V2017N	9	63	056939
V2018N	10	63	056946
V2019N	11	63	056953
V2020N	12	63	056960
V2311N	13	63	057509
V2312N	14	63	057516
V2313N	15	63	057523
V2314N	17	63	057530
V2315N	19	63	057547

TORX® Socket

10 3/8" 



VIGOR No.	Size mm	Length mm	EAN 4047728+
V2724	E4	28	027243
V2725	E5	28	027250
V2726	E6	28	027267
V2727	E7	28	027274
V2728	E8	28	027281
V2143	E10	28	021432
V2614N	E11	28	058674
V2144	E12	28	021449
V2145	E14	28	021456
V2146	E16	28	021463
V2615N	E18	28	058681
V2729	E20	28	027298

Spark plug socket

10 3/8" 



VIGOR No.	Size mm	Length mm	EAN 4047728+
V2119N	16	66	057028
V2613N	18	66	058667
V2120N	21	66	057035

Sockets



Screwdriver socket

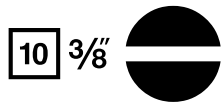

VIGOR No.	Size mm	Length mm	EAN 4047728+
V2288N	0,8x5,5	49	057318
V2287N	1x7	49	057301
V2286N	1,2x8	49	057295

Screwdriver socket



VIGOR No.	Size mm	Length mm	EAN 4047728+
V2291N	PZ1	49	057349
V2290N	PZ2	49	057332
V2289N	PZ3	49	057325

Screwdriver socket



VIGOR No.	Size mm	Length mm	EAN 4047728+
V2294N	PH1	49	057370
V2293N	PH2	49	057363
V2292N	PH3	49	057356

TORX® screwdriver socket



VIGOR No.	Size mm	Length mm	EAN 4047728+
V2193	T40H	48	021937
V2194	T45H	48	021944
V2195	T50H	48	021951



TORX® screwdriver socket

10 3/8



VIGOR No.	Size mm	mm	EAN 4047728+
V6074	T20	48	060745
V6075	T25	48	060752
V6076	T27	48	060769
V6077	T30	48	060776
V6078	T40	48	060783
V6079	T45	48	060790
V6080	T50	48	060806
V6081	T55	48	060813
V6082	T60	48	060820
V6083	T70	48	060837

TORX® screwdriver socket

10 3/8



VIGOR No.	Size mm	mm	EAN 4047728+
V2303N	T15	49	057493
V2302N	T20	49	057486
V2301N	T25	49	057479
V2300N	T27	49	057462
V2299N	T30	49	057455
V2298N	T40	49	057448
V2297N	T45	49	057431
V2149	T47	49	021494
V2296N	T50	49	057394
V2295N	T55	49	057387

TORX® screwdriver socket

10 3/8



VIGOR No.	Size mm	mm	EAN 4047728+
V6084	T20	93	060844
V6085	T25	93	060851
V6086	T27	93	060868
V6087	T30	93	060875
V6088	T40	93	060882
V6089	T45	93	060899
V6090	T50	93	060905
V6091	T55	93	060912
V6092	T60	93	060929
V6093	T70	93	060936

TORX® screwdriver socket



VIGOR No.	Size mm	Length mm	EAN 4047728+
V6094	T40	133	060943
V6095	T45	133	060950
V6096	T50	133	060967
V6097	T55	133	060974
V6098	T60	133	060981
V6099	T70	133	060998

TORX® screwdriver socket



VIGOR No.	Size mm	Length mm	EAN 4047728+
V6100	T40	193	061001
V6101	T45	193	061018
V6102	T50	193	061025
V6103	T55	193	061032
V6104	T60	193	061049
V6105	T70	193	061056

Screwdriver socket



VIGOR No.	Size mm	Length mm	EAN 4047728+
V6106	M5	48	061063
V6107	M6	48	061070
V6108	M8	48	061087
V6109	M9	48	061094
V6110	M10	48	061100
V6111	M12	48	061117
V6112	M14	48	061124
V6113	M16	48	061131



Screwdriver socket

10 3/8"



VIGOR No.	Size mm	mm	EAN 4047728+
V6114	M5	93	061148
V6115	M6	93	061155
V6116	M8	93	061162
V6117	M9	93	061179
V6118	M10	93	061186
V6119	M12	93	061193
V6120	M14	93	061209

Screwdriver socket

10 3/8"



VIGOR No.	Size mm	mm	EAN 4047728+
V6121	M5	133	061216
V6122	M6	133	061223
V6123	M8	133	061230
V6124	M9	133	061247
V6125	M10	133	061254
V6126	M12	133	061261
V6127	M14	133	061278

Screwdriver socket

10 3/8"



VIGOR No.	Size mm	mm	EAN 4047728+
V6128	M8	193	061285
V6129	M10	193	061292
V6130	M12	193	061308
V6131	M14	193	061315

Screwdriver socket



VIGOR No.	Size mm	mm	EAN 4047728+
V6132	5	48	061322
V6133	6	48	061339
V6134	7	48	061346
V6135	8	48	061353
V6136	10	48	061360
V6137	12	48	061377
V6138	14	48	061384
V6139	17	48	061391
V6140	19	48	061407

Screwdriver socket

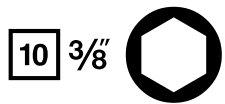

VIGOR No.	Size mm	mm	EAN 4047728+
V2285N	3	49	057288
V2284N	4	49	057271
V2283N	5	49	057264
V2282N	6	49	057257
V2281N	7	49	057240
V2280N	8	49	057233
V2279N	10	49	057226

Screwdriver socket

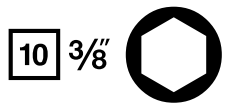

VIGOR No.	Size mm	mm	EAN 4047728+
V6141	5	93	061414
V6142	6	93	061421
V6143	7	93	061438
V6144	8	93	061445
V6145	10	93	061452
V6146	11	93	061469
V6147	12	93	061476
V6148	13	93	061483



Screwdriver socket

10 3/8 



VIGOR No.	Size mm	mm	EAN 4047728+
V6149	5	133	061490
V6157	6	133	061575
V6151	7	133	061513
V6152	8	133	061520
V6153	10	133	061537
V6154	12	133	061544
V6155	14	133	061551

Screwdriver socket

10 3/8 



VIGOR No.	Size mm	mm	EAN 4047728+
V6156	5	193	061568
V6194	6	193	062466
V6158	7	193	061582
V6159	8	193	061599
V6160	10	193	061605
V6161	12	193	061612

Sliding head / adapter

12 1/2 10 3/8



VIGOR No.	mm	EAN 4047728+
V2116N	40	056991

Universal joint

10 3/8 10 3/8



VIGOR No.	mm	EAN 4047728+
V2118N	50	057011

Bit adapter

10 3/8" **8** 5/16"



VIGOR No.	mm	EAN 4047728+
V2114N	28	056977

Adapter

10 3/8" **6.3** 1/4"



VIGOR No.	mm	EAN 4047728+
V2071	27	020718

Adapter

10 3/8" **12.5** 1/2"



VIGOR No.	mm	EAN 4047728+
V2108	36	021081

Bit adapter

8 5/16" **10** 3/8"



VIGOR No.	mm	EAN 4047728+
V3652N	30	058889



Extension

10 3/8 10 3/8



VIGOR No.	mm	EAN 4047728+
V2115N	75	056984
V2616N	125	058698
V2117N	250	057004

Wobble extension

- Operation of screw connections in confined spaces and working in areas with restricted access
- Spherical, tapered outside square
- Angular movement to each side 8°

10 3/8 10 3/8 8°



VIGOR No.	mm	EAN 4047728+
V4314	36	043144
V4315	75	043151
V4316	250	043168



Sockets



V7202, EAN 4047728**068888**

Socket set, super flat

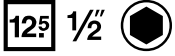

24

NEW



VIGOR No.	Designation	Size mm		EAN 4047728+
V7202-1	Reversible ratchet	-	12.5 1/2	069113
V7202-2	Square adapter	-	12.5 1/2	069120
V7202-3	Universal joint	-	12.5 1/2	069137
V7202-4	Extension, 125 mm	-	12.5 1/2	069144
V7202-5	Extension, 250 mm	-	12.5 1/2	069151
V7202-8	Socket, super flat	8	●	069168
V7202-9	Socket, super flat	9	●	069083
V7202-10	Socket, super flat	10	●	069090
V7202-11	Socket, super flat	11	●	069106
V7202-12	Socket, super flat	12	●	069212
V7202-13	Socket, super flat	13	●	069229
V7202-14	Socket, super flat	14	●	069236

VIGOR No.	Designation	Size mm		EAN 4047728+
V7202-15	Socket, super flat	15	●	069243
V7202-16	Socket, super flat	16	●	069250
V7202-17	Socket, super flat	17	●	069267
V7202-18	Socket, super flat	18	●	069274
V7202-19	Socket, super flat	19	●	069281
V7202-20	Socket, super flat	20	●	069298
V7202-21	Socket, super flat	21	●	069304
V7202-22	Socket, super flat	22	●	069311
V7202-24	Socket, super flat	24	●	069328
V7202-27	Socket, super flat	27	●	069335
V7202-30	Socket, super flat	30	●	069342
V7202-32	Socket, super flat	32	●	069359



V2460N, EAN 4047728**056458**

Socket set

12⁵ 1/2

NEW

25

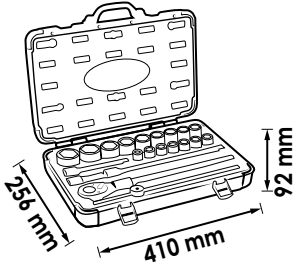

Single parts from page 162

X	Icon	Design	Size mm
18 x			10 · 11 · 12 · 13 · 14 · 15 · 16 · 17 · 18 · 19 · 20 · 21 · 22 · 23 · 24 · 27 · 30 · 32
2 x			16 · 21
1 x	-		250 mm
1 x			125 mm
1 x			250 mm
1 x			75 mm
1 x	-		250 mm



V2496, EAN 4047728**024969**

Screwdriver socket set

12⁵ 1/2

36



Single parts from page 164

X	Icon	Design	Size mm
8 x			M5 · M6 · M8 · M9 · M10 · M12 · M14 · M16
9 x			5 · 6 · 7 · 8 · 10 · 12 · 14 · 17 · 19
9 x			M5 · M6 · M7 · M8 · M9 · M10 · M12 · M13 · M14
10 x			T20 · T25 · T27 · T30 · T40 · T45 · T50 · T55 · T60 · T70



V1917, EAN 4047728019170
TORX® screwdriver socket set

125 1/2



Single parts see page 166

			Design	Size mm
10 x	125 1/2			T20 · T25 · T27 · T30 · T40 · T45 · T50 · T55 · T60 · T70
10 x	125 1/2			T20 · T25 · T27 · T30 · T40 · T45 · T50 · T55 · T60 · T70
6 x	125 1/2			T40 · T45 · T50 · T55 · T60 · T70
6 x	125 1/2			T40 · T45 · T50 · T55 · T60 · T70



32

V1918, EAN 4047728019187
Screwdriver socket set for screws with internal serration (XZN)

125 1/2



Single parts from page 165

			Design	Size mm
8 x	125 1/2			M5 · M6 · M8 · M9 · M10 · M12 · M14 · M16
7 x	125 1/2			M5 · M6 · M8 · M9 · M10 · M12 · M14
7 x	125 1/2			M5 · M6 · M8 · M9 · M10 · M12 · M14
4 x	125 1/2			M8 · M10 · M12 · M14



26



V1919, EAN 4047728019194

Screwdriver socket for inside hexagon screws

12⁵ 1/2



Single parts from page 164

X	■	○	Design	Size mm
9 x	12 ⁵ 1/2			5 · 6 · 7 · 8 · 10 · 12 · 14 · 17 · 19
8 x	12 ⁵ 1/2			5 · 6 · 7 · 8 · 10 · 11 · 12 · 13
7 x	12 ⁵ 1/2			5 · 6 · 7 · 8 · 10 · 12 · 14
6 x	12 ⁵ 1/2			5 · 6 · 7 · 8 · 10 · 12



30



V2201, EAN 4047728022019

RIBE screwdriver socket set

12⁵ 1/2



Single parts see page 167

X	■	⊛	Design	Size mm
9 x	12 ⁵ 1/2			M5 · M6 · M7 · M8 · M9 · M10 · M12 · M13 · M14
9 x	12 ⁵ 1/2			M5 · M6 · M7 · M8 · M9 · M10 · M12 · M13 · M14
7 x	12 ⁵ 1/2			M8 · M9 · M10 · M10.3 · M12 · M13 · M14
7 x	12 ⁵ 1/2			M8 · M9 · M10 · M10.3 · M12 · M13 · M14



32



V1898, EAN 4047728018982

Socket set with multi-purpose profile

12⁵ 1/2"



Single parts see page 164

X	■	Design	Size mm
17 x	12 ⁵ 1/2"		10 · 11 · 12 · 13 · 14 · 15 · 16 · 18 · 19 · 20 · 21 · 22 · 24 · 27 · 30 · 32 · 17

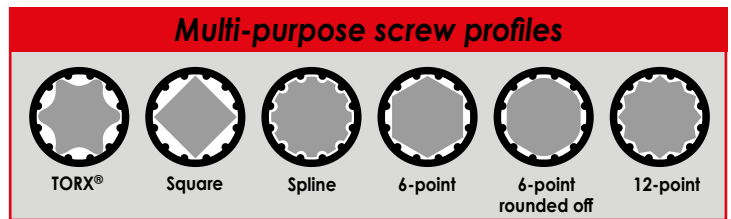

All sockets suitable for 6 different profiles!

17



V2404, EAN 4047728024044

Extractor socket with spiral profile set

• Operation of nuts with damaged heads (special profile)

12⁵ 1/2"



Single parts see page 171

X	■	Design	Size mm
9 x	12 ⁵ 1/2"		10 · 11 · 12 · 13 · 14 · 15 · 16 · 17 · 19



10



V3741, EAN 4047728037419

Extractor socket with spiral profile set

• Operation of nuts with damaged heads (special profile)

12⁵ 1/2"



Single parts see page 171

X	■	Design	Size mm
6 x	12 ⁵ 1/2"		21 · 22 · 24 · 27 · 30 · 32



7



V5550S, EAN 4047728055819

Impact socket set, short

- Impact operation
- Output: outside hexagon profile
- Surface: phosphatized

12⁵ 1/2

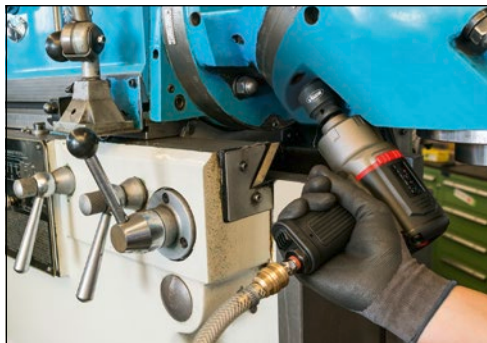

13

X	■	●	Design	Size mm
13 x	12 ⁵ 1/2			10 · 11 · 12 · 13 · 14 · 15 · 16 · 17 · 18 · 19 · 21 · 22 · 24



V5550L, EAN 4047728055505

Impact socket set, long

- Impact operation
- Output: outside hexagon profile
- Surface: phosphatized

12⁵ 1/2



13

X	■	●	Design	Size mm
13 x	12 ⁵ 1/2			10 · 11 · 12 · 13 · 14 · 15 · 16 · 17 · 18 · 19 · 21 · 22 · 24



Sockets



V7017, EAN 4047728**064705**

Impact screwdriver socket set
for internal TORX® profile

- Impact operation
- Surface: phosphatized



VIGOR No.	Size mm	Length mm	EAN 4047728+
V7017-T30	T30	78	066389
V7017-T40	T40	78	066396
V7017-T45	T45	78	066402
V7017-T50	T50	78	066419
V7017-T55	T55	78	066426
V7017-T60	T60	78	066242
V7017-T70	T70	78	066259
V7017-T80	T80	78	066266



NEW



V7018, EAN 4047728**066846**

Impact screwdriver socket set
for internal serration profile (XZN)

- Impact operation
- Surface: phosphatized

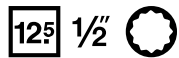

VIGOR No.	Size mm	Length mm	EAN 4047728+
V7018-M5	M5	78	066273
V7018-M6	M6	78	066280
V7018-M8	M8	78	066297
V7018-M10	M10	78	066303
V7018-M12	M12	78	066518
V7018-M14	M14	78	066525
V7018-M16	M16	78	066532
V7018-M18	M18	78	066549



NEW



V7019, EAN 4047728**066372**

Impact screwdriver socket set
for inside hexagon profile

- Impact operation
- Surface: phosphatized



VIGOR No.	Size mm	Length mm	EAN 4047728+
V7019-H5	H5	78	066556
V7019-H6	H6	78	066563
V7019-H8	H8	78	066570
V7019-H10	H10	78	066587
V7019-H12	H12	78	066594
V7019-H14	H14	78	066600
V7019-H17	H17	78	066617
V7019-H19	H19	78	066624



NEW



V6012, EAN 4047728055826

Fine-tooth reversible ratchet

- Offset design
- Plastic coating
- Quick-release press-button
- 72 teeth
- 5° opening angle
- DIN 3122, ISO 3315

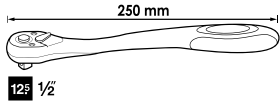

12.5 1/2"

V6012-REP, EAN 4047728056533

Repair set

- Repair set for fine-tooth reversible ratchet V6012 · V6612



V5437, EAN 4047728054379

360° rotary handle reversible ratchet

- Use in areas with restricted access
- Sliding square for clockwise/anti-clockwise operation
- Standard operation possible through locking function
- Only clockwise operation
- 72 teeth
- 5° opening angle



Loosening and tightening of screw connections only in locked mode!

Actuator mechanism in the handle

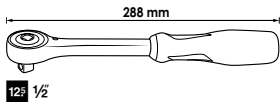

12.5 1/2"



V4946, EAN 4047728049467

Fine-tooth reversible ratchet, long design

- Robust and service-friendly
- Closed system
- Easy to clean
- 72 teeth
- 5° opening angle
- DIN 3122, ISO 3315

Substantially higher than the load requirements of DIN 3122!

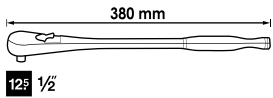

12.5 1/2"



V4946-REP, EAN 4047728049498

Repair set

- Repair set for fine-tooth reversible ratchets V4946 · V4946-S



Closed system



Sturdy solid steel design



V4946-S, EAN 4047728055369

Fine-tooth reversible ratchet, standard

- Robust and service-friendly
- Closed system
- Easy to clean
- 72 teeth
- 5° opening angle
- DIN 3122, ISO 3315

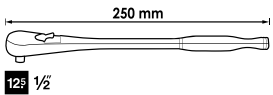

12.5 1/2"



V4884, EAN 4047728048842

Flexible handle with reversible ratchet

- Square drive with ball locking device
- DIN 3122



Robust 24-tooth ratchet mechanism

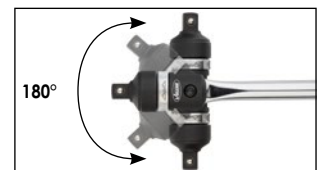

180°



12.5 1/2"



Sockets



V6612, EAN 4047728066464

Telescopic reversible ratchet with hinge joint

- Telescopic range 350–490 mm
- 180° swivel head with locking mechanism
- Quick-release press-button
- 72 teeth
- 5° opening angle

Example on V6638

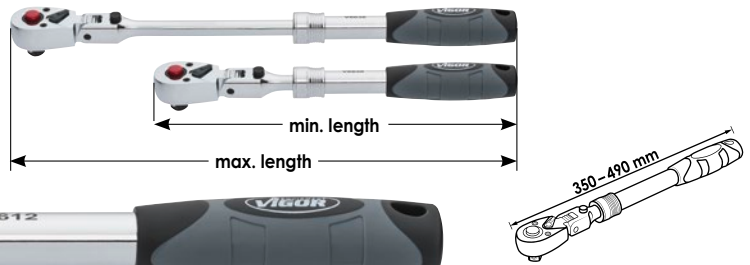

12⁵ 1/2"



NEW

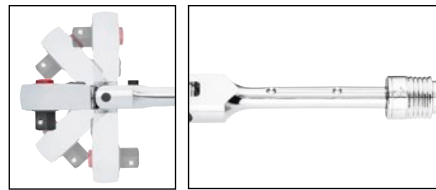

Latches in 5 positions
Can be adjusted to various fixing points

V6012-REP, EAN 4047728056533

Repair set

- Repair set for fine-tooth reversible ratchet V6012 · V6612



Socket

12⁵ 1/2"



VIGOR No.	Size mm	mm	EAN 4047728+
V4709N	8	38	058902
V2465N	10	38	058186
V2598N	11	38	058629
V2603N	12	38	058650
V2599N	13	38	058636
V2600N	14	38	058643
V2561N	15	38	058261
V2562N	16	38	058278
V2563N	17	38	058285
V2564N	18	38	058292

VIGOR No.	Size mm	mm	EAN 4047728+
V2565N	19	38	058308
V2566N	20	38	058315
V2567N	21	38	058322
V2568N	22	38	058339
V2569N	23	38	058346
V2570N	24	38	058353
V2571N	27	42	058360
V2572N	30	44	058377
V2574N	32	44	058384

Socket, long

12⁵ 1/2"



VIGOR No.	Size mm	mm	EAN 4047728+
V2579N	10	77	058445
V2580N	11	77	058452
V2581N	12	77	058469
V2584N	13	77	058483
V2585N	14	77	058490
V2586N	15	77	058506
V2587N	16	77	058513
V2588N	17	77	058520
V2589N	18	77	058537
V2590N	19	77	058544
V2591N	22	77	058551

TORX® Socket

12⁵ 1/2"



VIGOR No.	Size mm	mm	EAN 4047728+
V2730	E10	38	027304
V2731	E11	38	027311
V2732	E12	38	027328
V2733	E14	38	027335
V2734	E16	38	027342
V2196	E18	38,2	021968
V2197	E20	38,2	021975
V2735	E22	38	027359
V2592N	E24	38	058568

Spark plug socket



VIGOR No.	Size mm	Length mm	EAN 4047728+
V2578N	16	66	058438
V2582N	21	66	058476

Socket with multi-purpose profile

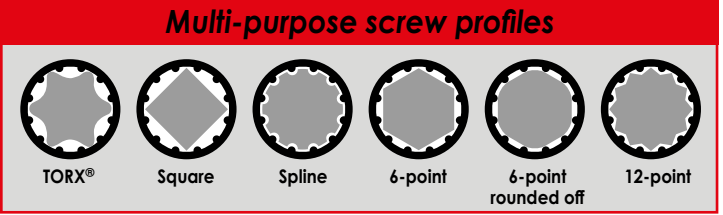

All sockets suitable for 6 different profiles!

VIGOR No.	Size mm	Length mm	EAN 4047728+
V1988	10	38,1	019880
V1989	11	38,1	019897
V1990	12	38,1	019903
V1991	13	38,1	019910
V1992	14	38,1	019927
V1993	15	38,1	019934
V1994	16	38,1	019941
V1995	17	38,1	019958
V1996	18	38,1	019965

VIGOR No.	Size mm	Length mm	EAN 4047728+
V1997	19	38,1	019972
V1998	20	38,1	019989
V1999	21	38,1	019996
V2000	22	38,1	020008
V2001	24	40	020015
V2002	27	42	020022
V2003	30	45	020039
V2004	32	45	020046

Screwdriver socket for inside hexagon screws

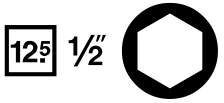

VIGOR No.	Size mm	Length mm	EAN 4047728+
V2101	5	55	021012
V2102	6	55	021029
V2103	7	55	021036
V2104	8	55	021043
V2105	10	55	021050
V2106	12	55	021067
V2107	14	55	021074
V2069	17	55	020695
V2070	19	55	020701

Screwdriver socket for inside hexagon screws



VIGOR No.	Size mm	Length mm	EAN 4047728+
V2072	5	100	020725
V2073	6	100	020732
V2074	7	100	020749
V2075	8	100	020756
V2076	10	100	020763
V2077	11	100	020770
V2078	12	100	020787
V2079	13	100	020794

Screwdriver socket for inside hexagon screws



VIGOR No.	Size mm	Length mm	EAN 4047728+
V2080	5	140	020800
V2081	6	140	020817
V2082	7	140	020824
V2083	8	140	020831
V2084	10	140	020848
V2085	12	140	020855
V2086	14	140	020862

Screwdriver socket for inside hexagon screws



VIGOR No.	Size mm	Length mm	EAN 4047728+
V2087	5	200	020879
V2088	6	200	020886
V2089	7	200	020893
V2090	8	200	020909
V2091	10	200	020916
V2092	12	200	020923

Screwdriver socket for screws with internal serration (XZN)



VIGOR No.	Size mm	Length mm	EAN 4047728+
V2094	M5	55	020947
V2095	M6	55	020954
V2096	M8	55	020961
V2097	M9	55	020978
V2098	M10	55	020985
V2099	M12	55	020992
V2065	M14	55	020657
V2100	M16	55	021005

Screwdriver socket for screws with internal serration (XZN)



VIGOR No.	Size mm	Length mm	EAN 4047728+
V2066	M5	100	020664
V2068	M6	100	020688
V2067	M8	100	020671
V2113	M9	100	021135
V2059	M10	100	020596
V2060	M12	100	020602
V2121	M14	100	021210

Screwdriver socket for screws with internal serration (XZN)



VIGOR No.	Size mm	Length mm	EAN 4047728+
V2122	M5	140	021227
V2124	M6	140	021241
V2123	M8	140	021234
V2126	M9	140	021265
V2128	M10	140	021289
V2129	M12	140	021296
V2132	M14	140	021326





Screwdriver socket for screws with internal serration (XZN)



VIGOR No.	Size mm	mm	EAN 4047728+
V2133	M8	200	021333
V2134	M10	200	021340
V2135	M12	200	021357
V2137	M14	200	021371

TORX® screwdriver socket



VIGOR No.	Size mm	mm	EAN 4047728+
V2151	T20	55	021517
V2152	T25	55	021524
V2153	T27	55	021531
V2154	T30	55	021548
V2155	T40	55	021555
V2156	T45	55	021562
V2157	T50	55	021579
V2158	T55	55	021586
V2159	T60	55	021593
V2160	T70	55	021609

TORX® screwdriver socket



VIGOR No.	Size mm	mm	EAN 4047728+
V2161	T20	100	021616
V2162	T25	100	021623
V2163	T27	100	021630
V2165	T30	100	021654
V2167	T40	100	021678
V2168	T45	100	021685
V2169	T50	100	021692
V2170	T55	100	021708
V2171	T60	100	021715
V2172	T70	100	021722

TORX® screwdriver socket



VIGOR No.	Size mm	mm	EAN 4047728+
V2173	T40	140	021739
V2174	T45	140	021746
V2175	T50	140	021753
V2176	T55	140	021760
V2177	T60	140	021777
V2178	T70	140	021784

TORX® screwdriver socket



VIGOR No.	Size mm	mm	EAN 4047728+
V2179	T40	200	021791
V2180	T45	200	021807
V2181	T50	200	021814
V2182	T55	200	021821
V2183	T60	200	021838
V2184	T70	200	021845

Sockets



RIBE screwdriver socket



VIGOR No.	Size mm	mm	EAN 4047728+
V2202	M5	55	022026
V2203	M6	55	022033
V2204	M7	55	022040
V2205	M8	55	022057
V2206	M9	55	022064
V2207	M10	55	022071
V2208	M12	55	022088
V2209	M13	55	022095
V2210	M14	55	022101

RIBE screwdriver socket



VIGOR No.	Size mm	mm	EAN 4047728+
V2211	M5	100	022118
V2212	M6	100	022125
V2213	M7	100	022132
V2214	M8	100	022149
V2215	M9	100	022156
V2216	M10	100	022163
V2217	M12	100	022170
V2218	M13	100	022187
V2219	M14	100	022194

RIBE screwdriver socket



VIGOR No.	Size mm	mm	EAN 4047728+
V2220	M8	140	022200
V2221	M9	140	022217
V2222	M10	140	022224
V2223	M10.3	140	022231
V2224	M12	140	022248
V2225	M13	140	022255
V2226	M14	140	022262

RIBE screwdriver socket



VIGOR No.	Size mm	mm	EAN 4047728+
V2227	M8	200	022279
V2228	M9	200	022286
V2229	M10	200	022293
V2230	M10.3	200	022309
V2231	M12	200	022316
V2232	M13	200	022323
V2233	M14	200	022330

TORX® screwdriver socket



VIGOR No.	Size mm	mm	EAN 4047728+
V2200	T55H	55	022002



Sliding T-handle

12⁵ 1/2"



VIGOR No.	mm	EAN 4047728+
V2573N	250	058391

Sliding piece

12⁵ 1/2"



VIGOR No.	mm	EAN 4047728+
V2667N	43,7	058728

Universal joint

12⁵ 1/2" **12⁵** 1/2"



VIGOR No.	mm	EAN 4047728+
V2575N	75	058407

Adapter

12⁵ 1/2" **10** 3/8"



VIGOR No.	mm	EAN 4047728+
V2109	36	021098

Sockets



Adapter

125 1/2" 20 3/4"



VIGOR No.	mm	EAN 4047728+
V2110	46	021104

Bit adapter

125 1/2" 8 5/16"



VIGOR No.	mm	EAN 4047728+
V2647N	37	058711

Extension

125 1/2" 125 1/2"

VIGOR No.	mm	EAN 4047728+
V2576N	125	058414
V2577N	250	058421
V4398N	750	058896



Wobble extension

- Operation of screw connections in confined spaces and working in areas with restricted access
- Spherical, tapered outside square

6.3 1/4" 6.3 1/4" 8°

VIGOR No.	mm	EAN 4047728+
V4317	50	043175
V4318	75	043182
V4319	250	043199



Impact socket, short

- Impact operation
- Surface phosphatized

12⁵ 1/2

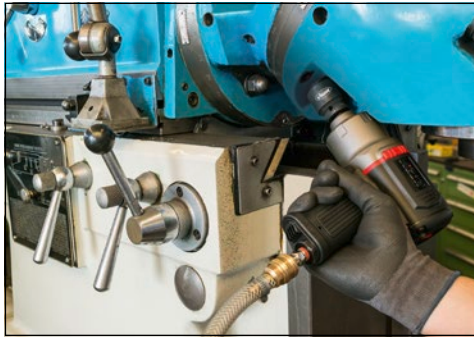

VIGOR No.	Size mm	EAN 4047728+
V5550S-10	10	056175
V5550S-11	11	056182
V5550S-12	12	056199
V5550S-13	13	056205
V5550S-14	14	056212
V5550S-15	15	056229
V5550S-16	16	056236
V5550S-17	17	056243
V5550S-18	18	056250
V5550S-19	19	056267
V5550S-21	21	056274
V5550S-22	22	056281
V5550S-24	24	056298

Impact socket, long

- Impact operation
- Surface phosphatized

12⁵ 1/2



VIGOR No.	Size mm	EAN 4047728+
V5550L-10	10	056045
V5550L-11	11	056052
V5550L-12	12	056069
V5550L-13	13	056076
V5550L-14	14	056083
V5550L-15	15	056090
V5550L-16	16	056106
V5550L-17	17	056113
V5550L-18	18	056120
V5550L-19	19	056137
V5550L-21	21	056144
V5550L-22	22	056151
V5550L-24	24	056168

12-point impact socket, short

- Extra thin-walled socket for cardan shaft screw connections in the wheel hub
- Borehole for locking pin or safety spring and groove for o-ring
- Adjusted to given spaces in the wheel hub
- E.g. for: VW Touareg model years 2003 →
AUDI A4 model years 2001 →, A6 model years 2005 →,
A8 model years 2003 →, Q7 model years 2007 →
and other models

12⁵ 1/2



32 mm

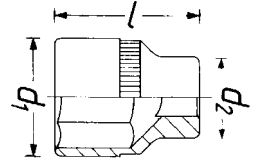

VIGOR No.	Size mm	d1 mm	d2 mm	mm	EAN 4047728+
V4477	32	44,4	30	50	044776

12-point impact socket, short

- Extra thin-walled socket for cardan shaft screw connections in the wheel hub
- Borehole for locking pin or safety spring and groove for o-ring
- Adjusted to given spaces in the wheel hub
- For e.g.: OPEL Corsa D model year 2006 →,
Adam model year 2012 →, Mokka model year 2012 →,
CHEVROLET Trax model year 2013 → and other models
- Also suitable for BMW, SEAT and VW vehicles

12⁵ 1/2



36 mm

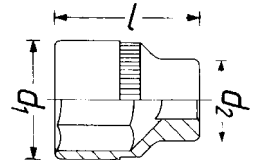

VIGOR No.	Size mm	d1 mm	d2 mm	mm	EAN 4047728+
V4478	36	46,9	30	50	044783

Extractor socket with spiral profile

- Operation of nuts with damaged heads (special profile)

12⁵ 1/2



VIGOR No.	Size mm	mm	EAN 4047728+
V2405	10	34	024051
V2402	11	34	024020
V2406	12	34	024068
V2407	13	34	024075
V2401	14	34	024013
V2408	15	34	024082
V2403	16	34	024037
V2409	17	34	024099
V2410	19	34	024105
V3742	21	34	037426
V3743	22	34	037433
V3744	24	34	037440
V3745	27	34	037457
V3746	30	34	037464
V3747	32	34	037471



V2318N, EAN 4047728059299

Socket set

20 3/4"

21

NEW

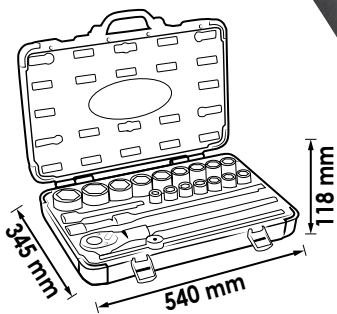

Single parts from page 173

X	■	●	Design	Size mm
16 x	20 3/4"			19 · 21 · 22 · 23 · 24 · 26 · 27 · 28 · 32 · 34 · 36 · 38 · 41 · 46 · 50 · 30
1 x	-	20 3/4"		500 mm
1 x	20 3/4"	20 3/4"		100 mm
1 x	20 3/4"	20 3/4"		200 mm
1 x	20 3/4"	20 3/4"		400 mm
1 x	-	20 3/4"		450 mm

Socket

20 3/4"



VIGOR No.	Size mm	mm	EAN 4047728+
V2323N	19	50	057165
V2324N	21	50	057172
V2325N	22	50	057189
V2326N	23	50	057196
V2327N	24	50	057202
V2328N	26	50	057615
V2329N	27	52	057622
V2256N	28	52	057059
V2331N	32	56	057646
V2332N	34	58	057653
V2333N	36	58	057677
V2334N	38	60	057684
V2337N	41	64	057721
V2336N	46	68	057707
V2335N	50	68	057691

Adapter

12⁵ 1/2" **20** 3/4"



VIGOR No.	mm	EAN 4047728+
V2111	50	021111

V5024, EAN 4047728050241

Impact socket set

20 3/4"



- Extra thin-walled sockets for drive shaft screw joints in the wheel hub
- Adjusted to given spaces in the wheel hub
- Suitable for among others:
 - Size 24: VW Touran model year 2006 →
 - Size 30: VW Passat C, Golf 4, Polo, New Beetle · AUDI TT · ŠKODA Octavia, Superb, Fabia
 - Size 32: VW Touareg model year 2003 →
 - Size 36: BMW 3 Series · 5 Series · 7 Series · SEAT Ibiza · VW Polo, Golf Plus



VIGOR No.	Size mm	mm	d1 mm	d2 mm	EAN 4047728+
V5025	24	44	44,3	35	050258
V5026	30	50	44,3	42	050265
V5182	32	50	44,3	44,3	051828
V5183	36	50	44,3	46,9	051835

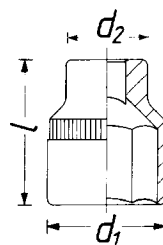

Extension

20 3/4" 20 3/4"



VIGOR No.	mm	EAN 4047728+
V2320N	100	057561
V2321N	200	057578
V2317N	400	057554

Sliding T-handle

20 3/4"



VIGOR No.	mm	EAN 4047728+
V2322N	450	057158

Reversible ratchet

20 3/4"



VIGOR No.	mm	EAN 4047728+
V2319N	500	059282

Flexible handle with reversible ratchet

- Commercial vehicles and industry
- Square drive with ball locking device
- Switchable with robust 24-tooth ratchet mechanism
- DIN 3122

20 3/4"

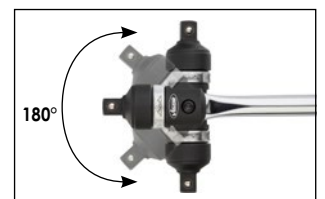

VIGOR No.	mm	EAN 4047728+
V4647	660	046473

Sockets



12-point socket

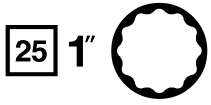

VIGOR No.	Size mm	mm	EAN 4047728+
V3375N	50	75	058803
V3376N	55	80	058810
V3377N	60	85	058827
V3378N	65	87	058834
V3379N	70	93	058841
V3380N	80	103	058858

Sliding piece



VIGOR No.	mm	EAN 4047728+
V3373N	50	058780

Sliding T-handle



VIGOR No.	mm	EAN 4047728+
V3374N	500	058797

Extension



VIGOR No.	mm	EAN 4047728+
V3280N	200	058766
V3371N	400	058773



V5505, EAN 4047728055055

Impact universal joint set

- Working in areas with restricted access, and for getting around obstructive edges
- Borehole for locking pin or safety spring and groove for o-ring



6.3	1/4"	6.3	1/4"
10	3/8"	10	3/8"
12.5	1/2"	12.5	1/2"

VIGOR No.	■	■	EAN 4047728+
V5505-1/4	6.3 1/4"	6.3 1/4"	055062
V5505-3/8	10 3/8"	10 3/8"	055079
V5505-1/2	12.5 1/2"	12.5 1/2"	055086

V1293, EAN 4047728012935

Adapter set



6.3	1/4"	10	3/8"
12.5	1/2"	20	3/4"
6.3	1/4"	10	3/8"
12.5	1/2"	20	3/4"

Single parts from page 138

X	■	■	Design	Size mm
1 x	6.3 1/4"	10 3/8"		26
1 x	10 3/8"	6.3 1/4"		27
1 x	10 3/8"	12.5 1/2"		36
1 x	12.5 1/2"	10 3/8"		36
1 x	12.5 1/2"	20 3/4"		46
1 x	20 3/4"	12.5 1/2"		50

V6039, EAN 4047728055857

Fine-tooth reversible ratchet set

- 72 teeth
- 5° opening angle
- Offset design
- Plastic coating
- Quick-release press-button
- Contents:
 - V6014 $12^5 \frac{1}{4}$
 - V6012 $12^5 \frac{1}{2}$
- DIN 3122, ISO 3315

6.3 $\frac{1}{4}$ **12⁵** $\frac{1}{2}$

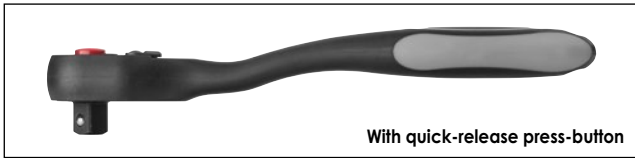

V4950-S, EAN 4047728055376

Fine-tooth reversible ratchet set

- Robust and service-friendly
- Closed system
- Easy to clean
- 72 teeth
- 5° opening angle
- DIN 3122, ISO 3315

6.3 $\frac{1}{4}$ **12⁵** $\frac{1}{2}$

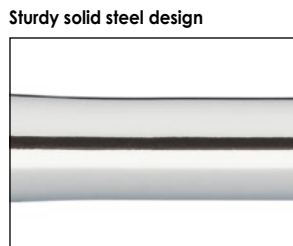

Powerful quality!
Exceeds DIN loading capacities!



V2687, EAN 4047728**026871**

TORX® socket set

6.3 1/4 10 3/8 12.5 1/2

28



Single parts from page 140

X	■	□	Design	Size mm
7 x		1/4		E4 · E5 · E6 · E7 · E8 · E10 · E11
12 x		3/8		E4 · E5 · E6 · E7 · E8 · E10 · E11 · E12 · E14 · E16 · E18 · E20
9 x		1/2		E10 · E11 · E12 · E14 · E16 · E18 · E20 · E22 · E24



V1781, EAN 4047728**017817**

TORX® socket set

6.3 1/4 10 3/8 12.5 1/2

34



Single parts from page 140

X	■	□	Design	Size mm
5 x		1/4		E4 · E5 · E6 · E7 · E8
7 x		1/4		T8 · T10 · T15 · T20 · T25 · T27 · T30
6 x		1/4		T9H · T10H · T15H · T20H · T25H · T30H
4 x		3/8		E10 · E12 · E14 · E16
3 x		3/8		T40H · T45H · T50H
4 x		3/8		T40 · T45 · T47 · T50
2 x		1/2		E18 · E20
2 x		1/2		T55 · T60
1 x		1/2		T55H



V5511, EAN 4047728**055116**

Bit set

10 3/8 10 3/8 12.5 1/2

42



X	■	□	Size mm	mm
2 x			8 · 10 mm	30 mm
2 x			PH 2 · PH 3	30 mm
8 x			T20 · T25 · T30 · T40 · T45 · T50 · T55 · T60	30 mm
7 x			4 · 5 · 6 · 7 · 8 · 10 · 12 mm	30 mm
5 x			M5 · M6 · M8 · M10 · M12	30 mm
8 x			T20 · T25 · T30 · T40 · T45 · T50 · T55 · T60	75 mm
4 x			5 · 6 · 8 · 10 mm	75 mm
4 x			M6 · M8 · M10 · M12	75 mm
1 x			Adapter	29 mm
1 x			Adapter	37 mm



Sockets

EQUIPMENT
VIGOR

V1706N, EAN 4047728056465

Socket set

6.3 1/4" 125 1/2" 8 5/16"



94

NEW

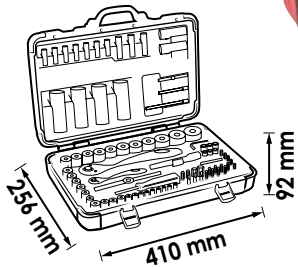

Single parts from page 135

X	■	■	Design	Size mm
13 x	6.3 1/4"	●		4 · 4.5 · 5 · 5.5 · 6 · 7 · 8 · 9 · 10 · 11 · 12 · 13 · 14
8 x	6.3 1/4"	●		6 · 7 · 8 · 9 · 10 · 11 · 12 · 13
4 x	6.3 1/4"	○		3 · 4 · 5 · 6
3 x	6.3 1/4"	●		0.8x4 · 1x5.5 · 1.2x7
2 x	6.3 1/4"	+		PH1 · PH2
2 x	6.3 1/4"	*		PZ1 · PZ2
5 x	6.3 1/4"	*		T10 · T15 · T20 · T25 · T30
1 x	6.3 1/4"	6.3 1/4"		50 mm
1 x	6.3 1/4"	6.3 1/4"		100 mm
1 x	6.3 1/4"	6.3 1/4"		145 mm
1 x	-	6.3 1/4"		150 mm
1 x	-	6.3 1/4"		150 mm
1 x	6.3 1/4"	6.3 1/4"		110 mm
1 x	6.3 1/4"	6.3 1/4"		40 mm
1 x	6.3 1/4"	6.3 1/4"		30 mm
3 x	-	○		1.5 · 2 · 2.5

X	■	■	Design	Size mm
1 x	-	125 1/2"		43.7 mm
18 x	125 1/2"	●		10 · 11 · 12 · 13 · 14 · 15 · 16 · 17 · 18 · 19 · 20 · 21 · 22 · 23 · 24 · 27 · 30 · 32
4 x	125 1/2"	●		14 · 15 · 17 · 19
2 x	125 1/2"	●		16 · 21
1 x	-	125 1/2"		250 mm
1 x	125 1/2"	125 1/2"		75 mm
1 x	125 1/2"	125 1/2"		125 mm
1 x	125 1/2"	125 1/2"		250 mm
1 x	125 1/2"	8 5/16"		37 mm
4 x	8 5/16"	*		T40 · T45 · T50 · T55
4 x	8 5/16"	○		8 · 10 · 12 · 14
2 x	8 5/16"	+		PH3 · PH4
2 x	8 5/16"	*		PZ3 · PZ4
3 x	8 5/16"	●		8 · 12 · 10

V2461N, EAN 4047728056472

Socket set

6.3 1/4" 8 5/16"

6.3 1/4" 10 3/8" 12.5 1/2"



NEW

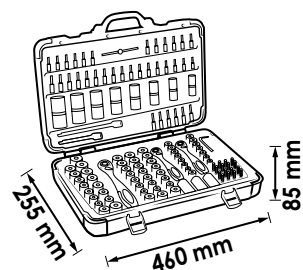

Single parts from page 135

X	■	Design	Size mm
13 x	6.3 1/4"		4 · 4.5 · 5 · 5.5 · 6 · 7 · 8 · 9 · 10 · 11 · 12 · 13 · 14
7 x	6.3 1/4"		4 · 5 · 6 · 7 · 8 · 9 · 10
5 x	6.3 1/4"		E4 · E5 · E6 · E7 · E8
4 x	6.3 1/4"		3 · 4 · 5 · 6
4 x	6.3 1/4"		0.8x4 · 1x5.5 · 1.2x6.5 · 1.2x7
3 x	6.3 1/4"		PH0 · PH1 · PH2
3 x	6.3 1/4"		PZ0 · PZ1 · PZ2
7 x	6.3 1/4"		T9 · T10 · T15 · T20 · T25 · T27 · T30
6 x	6.3 1/4"		T9H · T10H · T15H · T25H · T27H · T30H
1 x	6.3 1/4"	6.3 1/4"	50 mm
1 x	6.3 1/4"	6.3 1/4"	100 mm
1 x	-	6.3 1/4"	150 mm
1 x	-	6.3 1/4"	150 mm
1 x	6.3 1/4"	6.3 1/4"	110 mm
1 x	6.3 1/4"	6.3 1/4"	40 mm
1 x	6.3 1/4"	6.3 1/4"	30 mm
4 x	-		1.27 · 1.5 · 2 · 2.5
1 x	10 3/8"		18
1 x	-	10 3/8"	198 mm
1 x	10 3/8"	10 3/8"	50 mm
6 x	10 3/8"		E10 · E11 · E12 · E14 · E16 · E18
6 x	10 3/8"		10 · 11 · 12 · 13 · 14 · 15

X	■	Design	Size mm
10 x	10 3/8"		10 · 11 · 12 · 13 · 14 · 15 · 16 · 17 · 18 · 19
1 x	10 3/8"	8 5/16"	28 mm
1 x	10 3/8"	10 3/8"	125 mm
1 x	-	12.5 1/2"	43.7 mm
17 x	12.5 1/2"		10 · 11 · 12 · 13 · 14 · 15 · 16 · 17 · 18 · 19 · 20 · 21 · 22 · 24 · 27 · 30 · 32
5 x	12.5 1/2"		16 · 17 · 18 · 19 · 22
2 x	12.5 1/2"		E20 · E22
2 x	12.5 1/2"		16 · 21
1 x	12.5 1/2"	12.5 1/2"	75 mm
1 x	12.5 1/2"	12.5 1/2"	125 mm
1 x	12.5 1/2"	12.5 1/2"	250 mm
1 x	12.5 1/2"	8 5/16"	37 mm
5 x	6.3 1/4"		R5 · R6 · R7 · R8 · R9
9 x	6.3 1/4"		T5 · T6 · T7 · T40 · T45 · T50 · T55 · T60 · T70
3 x	6.3 1/4"		M5 · M6 · M8
13 x	6.3 1/4"		T7H · T10H · T15H · T20H · T25H · T27H · T30H · T40H · T45H · T50H · T55H · T60H · T70H
5 x	8 5/16"		7 · 8 · 10 · 12 · 14
2 x	8 5/16"		PH3 · PH4
2 x	8 5/16"		PZ3 · PZ4
3 x	8 5/16"		8 · 10 · 12

Sockets

V3277N, EAN 4047728056489

Socket set

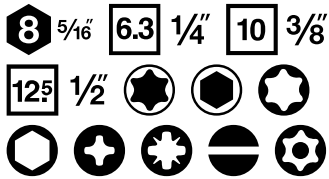

212

NEW

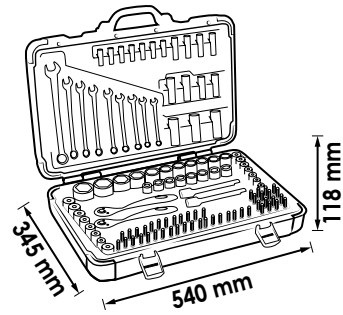

Single parts from page 135

X	■	□	Design	Size mm
3 x	6.3 1/4	+		PH1 · PH2 · PH3
3 x	6.3 1/4	+		PZ1 · PZ2 · PZ3
3 x	6.3 1/4	●		5.5 · 6 · 8
5 x	6.3 1/4	○		3 · 4 · 5 · 6 · 7
6 x	6.3 1/4	⊕		T15H · T20H · T25H · T27H · T30H · T40H
10 x	6.3 1/4	⊕		T8 · T9 · T10 · T15 · T20 · T25 · T27 · T30 · T40 · T45
4 x	8 5/16	○		7 · 8 · 10 · 12
3 x	8 5/16	●		8 · 10 · 12
3 x	8 5/16	+		PH2 · PH3 · PH4
3 x	8 5/16	+		PZ2 · PZ3 · PZ4
5 x	8 5/16	⊕		T40 · T45 · T50 · T55 · T60
5 x	8 5/16	⊕		T40H · T45H · T50H · T55H · T60H
4 x	8 5/16	⊕		R10 · R11 · R12 · R13
2 x	8 5/16	○		M10 · M12
1 x	-	6.3 1/4		200 mm
4 x	-	○		1.27 · 1.5 · 2 · 2.5
12 x	-	●, ○		8 · 9 · 10 · 11 · 12 · 13 · 14 · 15 · 17 · 19 · 22 · 24
1 x	10 3/8	8 5/16		28 mm
1 x	125 1/2	8 5/16		37 mm
1 x	6.3 1/4	6.3 1/4		25 mm
10 x	10 3/8	●		11 · 10 · 12 · 13 · 14 · 15 · 16 · 17 · 18 · 19

X	■	□	Design	Size mm
6 x	10 3/8	⊕		E18 · E16 · E14 · E12 · E11 · E10
6 x	10 3/8	●		10 · 11 · 12 · 13 · 14 · 15
14 x	125 1/2	●		13 · 14 · 15 · 16 · 17 · 18 · 19 · 20 · 21 · 22 · 24 · 27 · 30 · 32
3 x	125 1/2	⊕		E24 · E22 · E20
5 x	125 1/2	●		16 · 17 · 18 · 19 · 22
1 x	-	6.3 1/4		150 mm
13 x	6.3 1/4	●		4 · 4.5 · 5 · 5.5 · 6 · 7 · 8 · 9 · 10 · 11 · 12 · 13 · 14
5 x	6.3 1/4	⊕		E8 · E7 · E6 · E5 · E4
7 x	6.3 1/4	●		4 · 5 · 6 · 7 · 8 · 9 · 10
1 x	-	6.3 1/4		150 mm
1 x	-	10 3/8		198 mm
1 x	-	125 1/2		250 mm
1 x	125 1/2	125 1/2		75 mm
1 x	10 3/8	10 3/8		50 mm
1 x	6.3 1/4	6.3 1/4		40 mm
1 x	125 1/2	125 1/2		125 mm
1 x	10 3/8	10 3/8		125 mm
1 x	6.3 1/4	6.3 1/4		100 mm
1 x	6.3 1/4	6.3 1/4		50 mm
1 x	125 1/2	125 1/2		250 mm
2 x	125 1/2	●		21 · 16
1 x	10 3/8	●		18



V4425, EAN 4047728**044257**

Tool case, universal

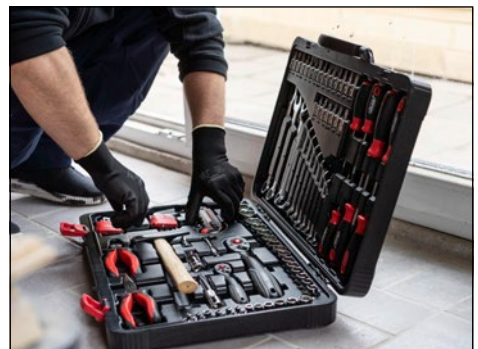
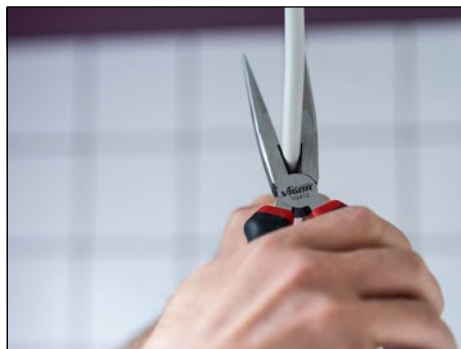

X	■	●	Design	Size mm
1 x	-	-		300 mm
1 x	-	-		-
3 x	-	●		0.6 x 3 · 0.8 x 4 · 1.0 x 5.5
3 x	-	●		PH0 · PH1 · PH2
1 x	-	○		1.5 - 10
1 x	-	●		T10 - T50
12 x	-	●		8 · 9 · 10 · 11 · 12 · 13 · 14 · 15 · 16 · 17 · 18 · 19
4 x	6.3	1/4		3 · 4 · 5 · 6
3 x	6.3	1/4		0.8 x 4 · 1 x 5.5 · 1.2 x 6.5
3 x	6.3	1/4		PH1 · PH2 · PH3
3 x	6.3	1/4		PZ1 · PZ2 · PZ3
6 x	6.3	1/4		T10 · T15 · T20 · T25 · T30 · T40

X	■	●	Design	Size mm
16 x	12.5	1/2		10 · 11 · 12 · 13 · 14 · 15 · 16 · 17 · 19 · 20 · 21 · 22 · 24 · 27 · 30 · 32
12 x	6.3	1/4		4 · 4.5 · 5 · 5.5 · 6 · 7 · 8 · 9 · 10 · 11 · 12 · 13
1 x	6.3	1/4		T27
1 x	6.3	1/4		40 mm
1 x	12.5	1/2		75 mm
1 x	6.3	1/4		100 mm
1 x	12.5	1/2		125 mm
1 x	-	-		160 mm
1 x	-	-		200 mm
1 x	-	6.3	1/4	150 mm
1 x	-	12.5	1/2	250 mm

Universal tool cases



V2542, EAN 4047728**025423**

Tool case, universal

• Tool case including assortment

143



VIGOR No.	Designation	EAN 4047728+
V2400	Case, empty, without soft foam insert	024006
V2464	Soft foam insert, universal tool case	024648



V1461N, EAN 4047728064934

Double open-end wrench set

- Matt chrome-plated
- DIN 3110
- Secure hold with oily hands thanks to anti-slip surface

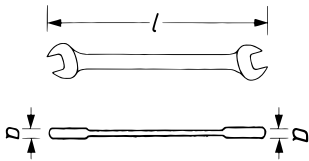

X	Design	Size mm
12 x		6x7 · 8x9 · 10x11 · 12x13 · 14x15 · 16x17 · 18x19 · 20x22 · 21x23 · 24x27 · 25x28 · 30x32



Double open-end wrench

- Matt chrome-plated
- DIN 3110

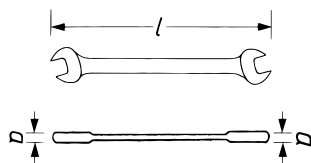

VIGOR No.	Size mm	a mm	L mm	EAN 4047728+
V1461N-6X7	6x7	3,4	126	064903
V1461N-8X9	8x9	3,6	142	064187
V1461N-10X11	10x11	4,5	157	064200
V1461N-12X13	12x13	5,1	170	064231
V1461N-14X15	14x15	5,4	187	064262
V1461N-16X17	16x17	6	202	064286
V1461N-18X19	18x19	7,3	220	064309
V1461N-20X22	20x22	7,3	232	064026
V1461N-21X23	21x23	7,5	246	064033
V1461N-22X24	22x24	7,8	248	064040
V1461N-24X27	24x27	8,4	265	064064
V1461N-25X28	25x28	8,5	275	064071
V1461N-30X32	30x32	9,2	298	064095



V4472N, EAN 4047728064958

Combination wrench set

- Long design
- 15° offset box-end wrench
- Matt chrome-plated
- DIN 3113 form A, ISO 7738
- Secure hold with oily hands thanks to anti-slip surface

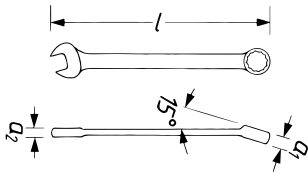

X	Design	Size mm
15 x		6 · 7 · 8 · 9 · 10 · 11 · 12 · 13 · 14 · 15 · 16 · 17 · 18 · 19 · 22



15



V4473N, EAN 4047728064965

Combination wrench set

- Long design
- 15° offset box-end wrench
- Matt chrome-plated
- DIN 3113 form A, ISO 7738
- Secure hold with oily hands thanks to anti-slip surface



X	Design	Size mm
22 x		6 · 7 · 8 · 9 · 10 · 11 · 12 · 13 · 14 · 15 · 16 · 17 · 18 · 19 · 20 · 21 · 22 · 24 · 27 · 30 · 32 · 36



22



Combination wrench

- Long design
- 15° offset box-end wrench
- Matt chrome-plated
- DIN 3113 form A, ISO 7738



VIGOR No.	Size mm	a1 mm	a2 mm	L mm	EAN 4047728+
V4473N-6	6	4,8	3,4	100	064439
V4473N-7	7	5,4	3,5	110	064446
V4473N-8	8	5,5	3,8	115	064453
V4473N-9	9	6	4	125	064460
V4473N-10	10	6,3	4,5	135	064477
V4473N-11	11	6,8	4,9	145	064484
V4473N-12	12	7,2	5	155	064491
V4473N-13	13	8,3	5,6	185	064507
V4473N-14	14	8,5	5,7	171	064514
V4473N-15	15	9,2	6,1	185	064323
V4473N-16	16	9,3	6,5	195	064569
V4473N-17	17	9,6	6,8	210	064576
V4473N-18	18	10,1	7,2	220	064583
V4473N-19	19	10,2	7,3	230	064590
V4473N-20	20	10,8	7,4	240	064606
V4473N-21	21	11,1	7,6	245	064613
V4473N-22	22	11,7	7,9	248	064408
V4473N-24	24	12,8	8,4	270	064712
V4473N-27	27	13,9	9,1	300	064736
V4473N-30	30	15,2	9,9	330	064743
V4473N-32	32	15,9	10,2	350	064750
V4473N-36	36	19,3	11,6	400	064767

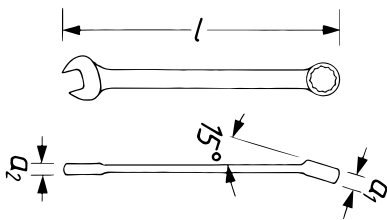

V1524N, EAN 4047728064910

Double box-end wrench set

- 15° offset
- DIN 838, ISO 10104
- Secure hold with oily hands thanks to anti-slip surface



X	Design	Size mm
11 x		6x7 · 8x9 · 10x11 · 14x15 · 16x17 · 18x19 · 20x22 · 21x23 · 24x27 · 25x28 · 30x32



Double box-end wrench

- 15° offset
- DIN 838, ISO 10104

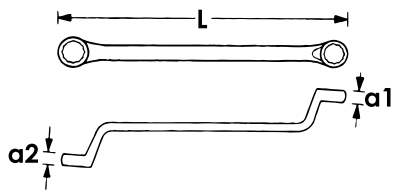

VIGOR No.	Size mm	a1 mm	a2 mm	mm	EAN 4047728+
V1524N-6X7	6x7	5,8	5	175	064774
V1524N-8X9	8x9	7,7	6,7	185	064781
V1524N-10X11	10x11	8,4	7,4	198	064798
V1524N-12X13	12x13	8,4	9,1	215	064804
V1524N-14X15	14x15	10,4	9,5	228	064811
V1524N-16X17	16x17	10,8	10	246	064828
V1524N-18X19	18x19	12,1	10,8	268	064835
V1524N-20X22	20x22	12,5	11,7	292	064842
V1524N-21X23	21x23	13,2	12,2	315	064859
V1524N-24X27	24x27	13,4	12,2	328	064866
V1524N-25X28	25x28	14,9	13,9	342	064873
V1524N-30X32	30x32	16	15,2	370	064880



V4951, EAN 4047728049511

Ratcheting open-end wrench set

- Integrated ratchet function on the jaw end of the wrench:
 - Operation of screw connections without having to reposition the tool
- Ratchet function in the wrench's jaws:
 - Working even in areas with restricted access
- Simplified mechanics to minimise flaws
- Including tool roll



X	Design	Size mm
5 x		8 · 10 · 13 · 17 · 19

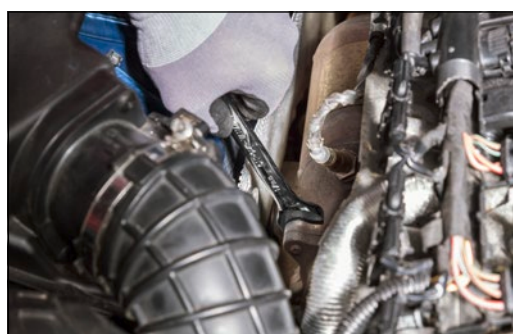

V5517, EAN 4047728055178

Ratcheting open-end wrench set

- Integrated ratchet function on the jaw end of the wrench:
 - Operation of screw connections without having to reposition the tool
- Ratchet function in the wrench's jaws:
 - Working even in areas with restricted access
- Simplified mechanics to minimise flaws
- Including tool roll



X	Design	Size mm
13 x		8 · 10 · 11 · 12 · 13 · 14 · 15 · 16 · 17 · 18 · 19 · 21 · 22



Ratcheting open-end wrench

- Integrated ratchet function on the jaw end of the wrench:
 - Operation of screw connections without having to reposition the tool
 - Working even in areas with restricted access
- Simplified mechanics to minimise flaws

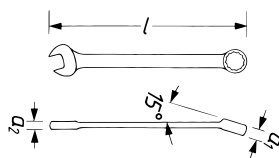
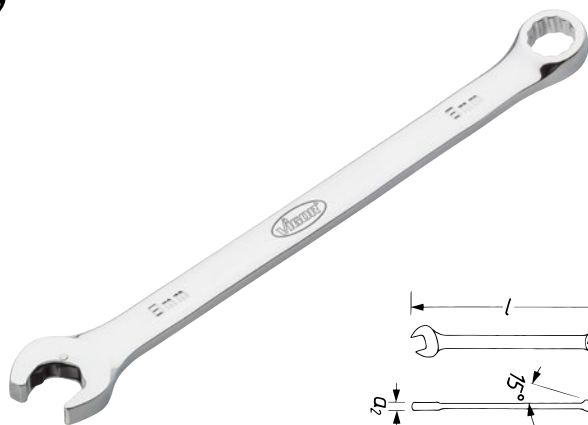

VIGOR No.	Size mm	a1 mm	a mm	L mm	EAN 4047728+
V4951-8	8	5	5,8	136	049528
V4951-10	10	6	6,9	161	049535
V4951-11	11	6,6	7,4	168	055185
V4951-12	12	7,5	7,9	174	055192
V4951-13	13	7,9	8,4	180	049542
V4951-14	14	8,5	8,9	193	055208
V4951-15	15	8,5	9,7	200	055215
V4951-16	16	9	10,4	207	055222
V4951-17	17	9,5	10,9	227	049559
V4951-18	18	9,8	11,2	239	055239
V4951-19	19	9,8	12,2	250	049566
V4951-21	21	9	13	254	055246
V4951-22	22	9,3	13,9	263	055253

V2815, EAN 4047728028158

Ratcheting combination wrench set, short

- Delivery in tool roll
- 72 teeth
- 5° opening angle



X	Design	Size mm
5 x		8 · 10 · 13 · 17 · 19



V2821, EAN 4047728028219

Ratcheting combination wrench set, short

- Delivery in tool roll
- 72 teeth
- 5° opening angle



X	Design	Size mm
12 x		8 · 9 · 10 · 11 · 12 · 13 · 14 · 15 · 16 · 17 · 18 · 19



Ratcheting combination wrench, short

- 72 teeth
- 5° opening angle

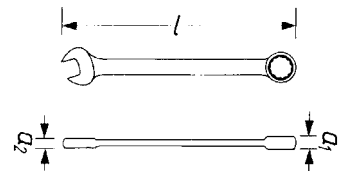

VIGOR No.	Size mm	a1 mm	a2 mm	L mm	EAN 4047728+
V2822	8	7,4	4,9	89	028226
V2823	9	7,5	5,2	93	028233
V2824	10	8,5	5,5	97	028240
V2825	11	8,4	6,1	102	028257
V2826	12	8,5	6,3	106	028264
V2827	13	8,4	6,7	110	028271
V2828	14	8,4	7	114	028288
V2829	15	8,4	7,4	120	028295
V2830	16	10	7,7	122	028301
V2831	17	10	7,7	126	028318
V2832	18	11,5	8,4	131	028325
V2833	19	11,5	8,6	136	028332



V2820, EAN 4047728028202

Ratcheting combination wrench set, long

- Tool roll
- 72 teeth
- 5° opening angle



X	Design	Size mm
5 x		8 · 10 · 13 · 17 · 19



V1031, EAN 4047728010313

Ratcheting combination wrench set, long

- Tool roll
- 72 teeth
- 5° opening angle



X	Design	Size mm
12 x		8 · 9 · 10 · 11 · 12 · 13 · 14 · 15 · 16 · 17 · 18 · 19



Ratcheting combination wrench, long

- 72 teeth
- 5° opening angle

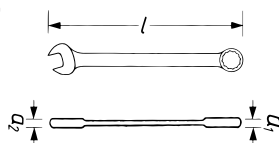

VIGOR No.	Size mm	$\frac{1}{2}$ a1 mm	$\frac{1}{2}$ a mm	l mm	EAN 4047728+
V3635	6	7,4	4,6	135	036351
V3636	7	7,4	4,7	144	036368
V1008	8	7,4	4,7	140	010085
V1009	9	7,4	5,3	151	010092
V1010	10	8,4	5,7	160	010108
V1021	11	8,4	6,1	165	010214
V1022	12	8,4	6,4	170	010221
V1023	13	8,4	6,6	177	010238
V1025	14	8,4	7,3	192	010252
V1026	15	8,4	7,5	200	010269
V1027	16	10	7,7	210	010276
V1028	17	10	7,9	225	010283
V1029	18	11,5	8,4	235	010290
V1030	19	11,5	8,7	245	010306
V4961	21	12,5	9	275	049610
V4962	22	13,5	10	285	049627
V4963	24	13,5	11	296	049634
V4964	27	13,5	12	340	049641
V4965	30	16	13	369	049658
V4966	32	16	14	395	049665

V6752/12, EAN 4047728068048

Double joint ratcheting combination wrench set

- Ratchet head with double hinge
- 12-point profile in ring
- In tool roll

NEW

12

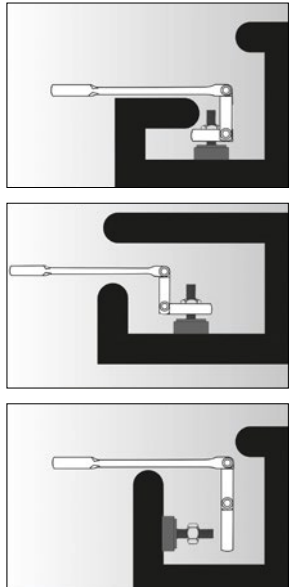

Size 8-19 mm



Double joint on ratcheting head

X	Size mm
12 x	8 · 9 · 10 · 11 · 12 · 13 · 14 · 15 · 16 · 17 · 18 · 19



Ratcheting combination wrench with double hinge

- Ratchet head with double hinge
- 12-point profile in ring

NEW

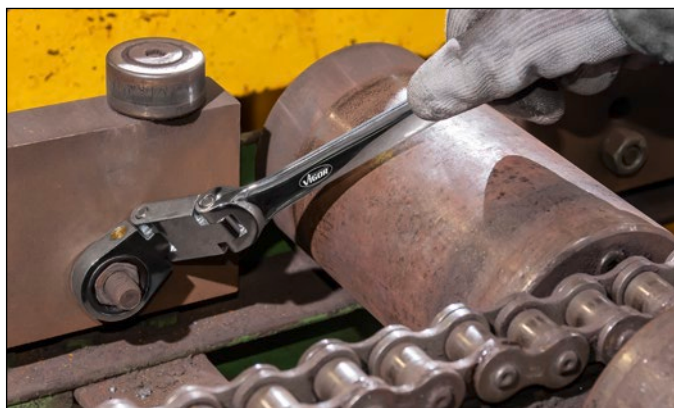
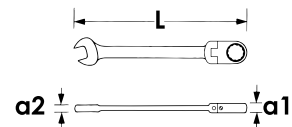

VIGOR No.	Size mm	a1 mm	a2 mm	L mm	EAN 4047728+
V6752-8	8	7,4	4,7	163	067522
V6752-9	9	7,4	5,3	168	067836
V6752-10	10	8,4	5,7	178	067843
V6752-11	11	8,4	6,1	186	067850
V6752-12	12	8,4	6,4	196	067867
V6752-13	13	8,4	6,6	206	067874
V6752-14	14	8,4	7,3	217	067881
V6752-15	15	8,4	7,5	228	067898
V6752-16	16	10	7,7	245	067904
V6752-17	17	10	7,9	259	068017
V6752-18	18	11,5	8,4	273	068024
V6752-19	19	11,5	8,7	285	068031



V2819, EAN 4047728028196

Ratcheting combination wrench set, with hinge

- Tool roll
- 72 teeth
- 5° opening angle



X	Design	Size mm
5 x		8 · 10 · 13 · 17 · 19



V2818, EAN 4047728028189

Ratcheting combination wrench set, with hinge

- Tool roll
- 72 teeth
- 5° opening angle



X	Design	Size mm
12 x		8 · 9 · 10 · 11 · 12 · 13 · 14 · 15 · 16 · 17 · 18 · 19



Ratcheting combination wrench with hinge

- 72 teeth
- 5° opening angle

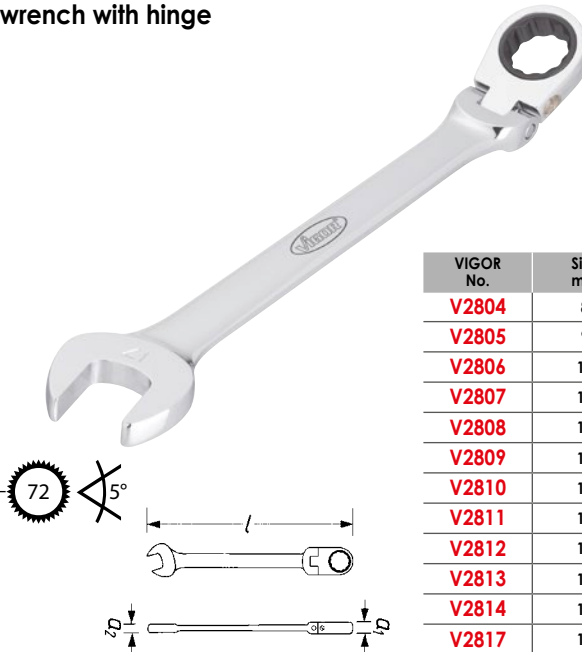

VIGOR No.	Size mm	a1 mm	a2 mm	L mm	EAN 4047728+
V2804	8	7,4	5	143	028042
V2805	9	7,4	5,3	150	028059
V2806	10	8,4	5,9	158	028066
V2807	11	8,4	6,1	165	028073
V2808	12	8,4	6,4	170	028080
V2809	13	8,4	6,7	182	028097
V2810	14	8,4	7,4	190	028103
V2811	15	8,5	7,6	200	028110
V2812	16	9,9	7,6	215	028127
V2813	17	10	8	228	028134
V2814	18	11,1	8,2	241	028141
V2817	19	11,5	8,7	250	028172

Wrenches

EQUIPMENT
VIGOR

V3607, EAN 4047728**036078**

Double ratcheting box-end wrench

- 72 teeth
- 5° opening angle

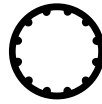

Multi-purpose profile

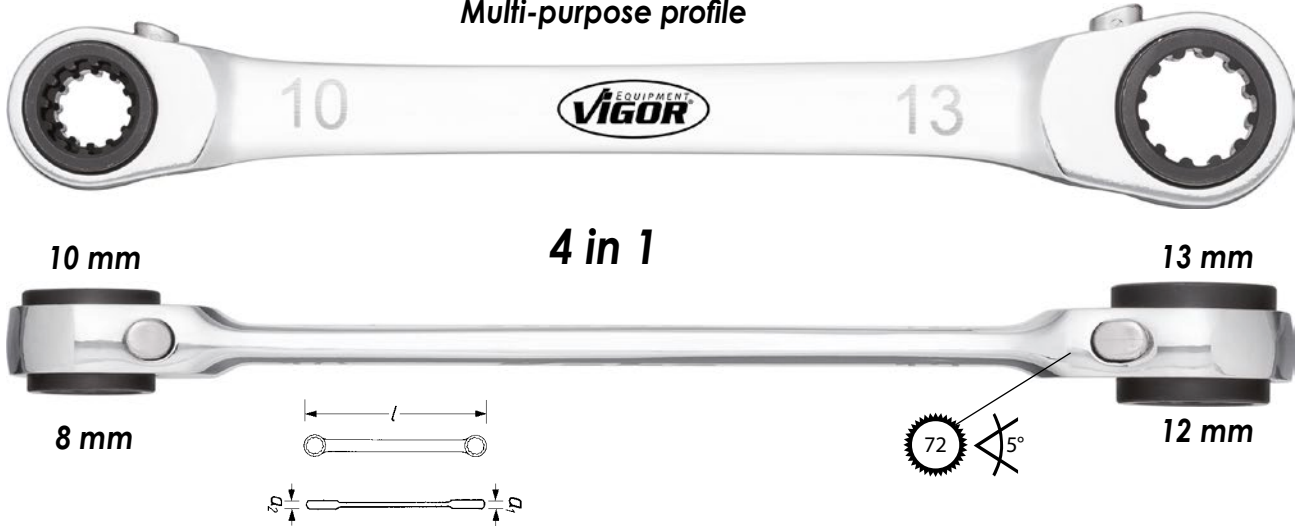

VIGOR No.	Size mm	a1 mm	a2 mm	L mm	EAN 4047728+
V3607	8x12 · 10x13	12,5	14,5	220	036078



V2705, EAN 4047728**027052**

Double ratcheting box-end wrench

- 72 teeth
- 5° opening angle



12-point

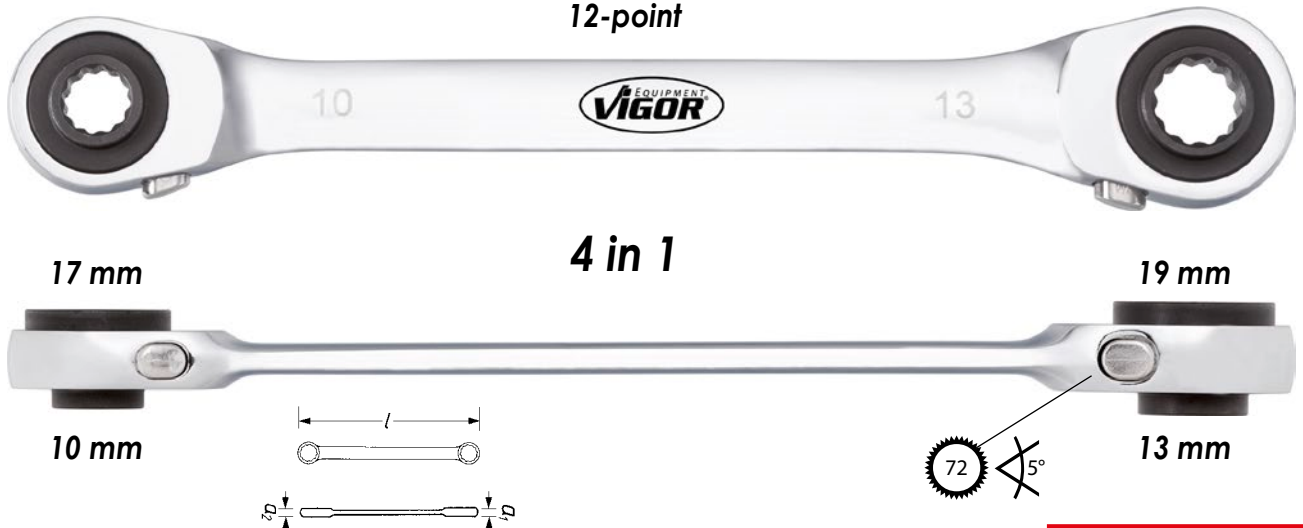

VIGOR No.	Size mm	a1 mm	a2 mm	L mm	EAN 4047728+
V2705	10x13 · 17x19	20	17	220	027052



V6048, EAN 4047728069625

Adjustable wrench

- One-hand wrench size adjustment using the adjustable wheel on the wrench head
- Head set angled at 15°
- Easily legible mm scale on the wrench head
- Clamping range 0–24 mm

NEW



Hanging hole

Slender, stable handle
Clamping range 0–24 mm

mm scale on the wrench head

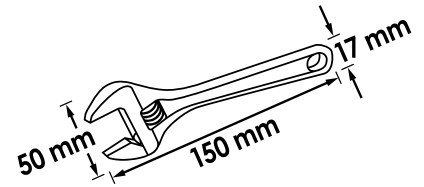

V6049, EAN 4047728069618

Adjustable wrench

- One-hand wrench size adjustment using the adjustable wheel on the wrench head
- Head set angled at 15°
- Easily legible mm scale on the wrench head
- Clamping range 0–33 mm

[Red box]

NEW



Hanging hole

Slender, stable handle
Clamping range 0–33 mm

mm scale on the wrench head

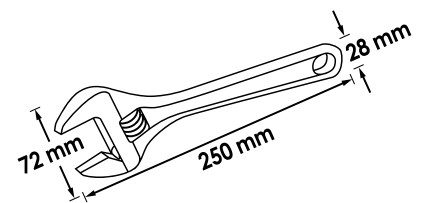

[Red box]

Screwdrivers and bits



V4655, EAN 4047728**046558**

Screwdriver set

• Manufactured according to DIN/ISO



2K System

12



X		Design	Size mm
1 x	⊖		1x5.5
5 x	⊖		0.6x3 · 0.8x4 · 1.0x5.5 · 1.6x8 · 1.6x10
1 x	⊕		PH2
4 x	⊕		PH0 · PH1 · PH2 · PH3



V1637, EAN 4047728**016377**

Screwdriver set

• Manufactured according to DIN/ISO



2K System

7



X		Design	Size mm
4 x	⊖		0.6x3 · 0.8x4 · 1.0x5.5 · 1.2x6.5
3 x	⊕		PH0 · PH1 · PH2



V1208, EAN 4047728**012089**

Screwdriver, short

• ⊖ 5.5x38 mm
• Manufactured according to DIN/ISO



2K System



V1209, EAN 4047728**012096**

Screwdriver, short

• ⊕ PH 2x38 mm
• Manufactured according to DIN/ISO



2K System



Screwdriver for slotted screws

• Manufactured according to DIN/ISO

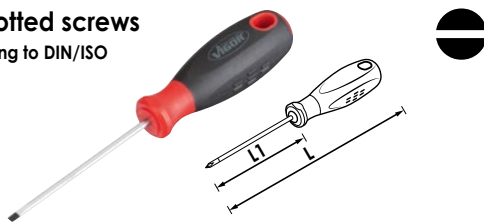

VIGOR No.	Size mm	L1 mm	L mm	EAN 4047728+
V1698	0,6x3	75	156	016988
V1699	0,8x4	80	161	016995
V1700	1,0x5,5	125	231	017008
V1701	1,2x6,5	150	256	017015
V3613	1,6x8	150	266	036139
V3609	1,6x10	175	291	036092

Phillips-Recess screwdriver

• Manufactured according to DIN/ISO



VIGOR No.	Size mm	L1 mm	L mm	EAN 4047728+
V1702	PH0	75	156	017022
V1703	PH1	80	186	017039
V1704	PH2	100	206	017046
V3610	PH3	150	266	036108



V3562, EAN 4047728035620

Screwdriver set with impact cap

• Manufactured according to DIN/ISO

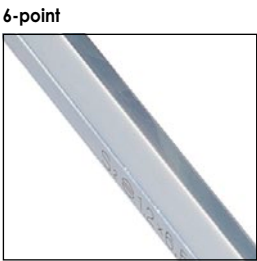

X	Design	Size mm
4 x		0.6x3.5 · 1.0x4.5 · 1x5.5 · 1.2x6.5
2 x		75 mm · 100 mm

Screwdriver with impact cap

• Manufactured according to DIN/ISO



VIGOR No.	Size mm	L1 mm	L mm	EAN 4047728+
V3597	0,6x3,5	75	157	035972
V3598	1,0x4,5	100	182	035989
V3599	1x5,5	100	207	035996
V3600	1,2x6,5	125	232	036009
V5042	1,6x8	150	267	050425
V5043	1,6x10	175	297	050432
V5044	2x12	200	317	050449

Phillips-recess screwdriver with impact cap

• Manufactured according to DIN/ISO



VIGOR No.	Size mm	L1 mm	L mm	EAN 4047728+
V3601	PH1	75	75	036016
V3602	PH2	100	100	036023
V4667	PH3	200	315	046671

Screwdrivers and bits



V4418, EAN 4047728**044189**

TORX® screwdriver set

• Manufactured according to DIN/ISO



X	Design	Size mm
4 x		T6 · T7 · T8 · T9



V3366, EAN 4047728**033664**

TORX® screwdriver set

• Manufactured according to DIN/ISO



X	Design	Size mm
7 x		T10 · T15 · T20 · T25 · T27 · T30 · T40



TORX® screwdriver

• Manufactured according to DIN/ISO

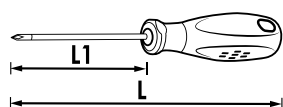

VIGOR No.	Size mm	L1 mm	L mm	EAN 4047728+
V4419	T6	74	154	044196
V4420	T7	74	154	044202
V4421	T8	74	154	044219
V4422	T9	74	154	044226
V3367	T10	100	206	033671
V3368	T15	100	206	033688
V3369	T20	100	206	033695
V3370	T25	100	206	033701
V3391	T27	100	206	033916
V3392	T30	100	206	033923
V3393	T40	100	206	033930



V5661, EAN 4047728056618

Screwdriver set, flexible

- Hose clamps on cooling water hoses
- Working even in confined areas that cannot be reached with a conventional screwdriver
- Design with double spiral spring including plastic coating
- Length: 300 mm



X	Design	Size mm
3 x		6 · 7 · 8



V5485N, EAN 4047728060714

Screwdriver set, extra long, flexible

- Working in areas with restricted access
- Extra long, length: 500 mm
- Universal 6.3 mm (1/4") screwdriver bit socket
- Universal 6.3 mm (1/4") square
- 7 mm 6-point output
- Contents:
 - 5 x 6-point sockets: 5 · 6 · 7 · 8 · 10 mm
 - 6 x bits 6.3 mm (1/4") for Inside TORX® profile: T10 · T15 · T20 · T25 · T27 · T30
 - 2 x bits 6.3 mm (1/4") for cross recess profile PH 1 · PH 2
 - 2 bits 6.3 mm (1/4") for slot profile 5.5 · 6.5



6.3 1/4" 6.3 1/4"



Flexible screwdriver

- Hose clamps on cooling water hoses
- Working even in confined areas that cannot be reached with a conventional screwdriver
- Design with double spiral spring including plastic coating

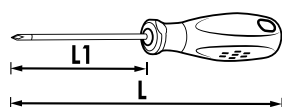
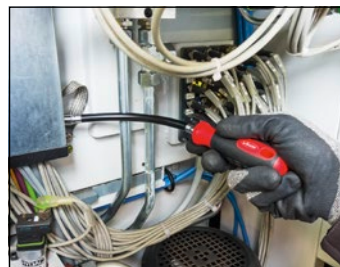

VIGOR No.	Size mm	mm	EAN
V4664	6	300	4047728+046640
V4665	7	300	4046657
V4666	8	300	4046664

Screwdrivers and bits



V4303, EAN 4047728**043038**

Electronic screwdriver set in plastic case

- Rotating head section and spinning area



X	■	Design	Size mm
4 x	●		1.6 · 2 · 2.4 · 3 mm
3 x	⊕		PH 00 · PH 0



2K System

6



V5601, EAN 4047728**056014**

Offset screwdriver set

- In clip
- Long design
- Ball-head
- Contents: 1.5 · 2 · 2.5 · 3 · 4 · 5 · 6 · 7 · 8 · 10 mm



Size 7 mm included

10



V4942, EAN 4047728**049429**

Offset screwdriver set

- In clip
- Long design
- Ball-head
- Contents: 1.5 · 2 · 2.5 · 3 · 4 · 5 · 6 · 8 · 10 mm



9



V4708, EAN 4047728**047081**

TORX® offset screwdriver set

- In clip
- Long design
- Ball-head
- Contents: T10 · T15 · T20 · T25 · T27 · T30 · T40 · T45 · T50



9



Offset screwdriver

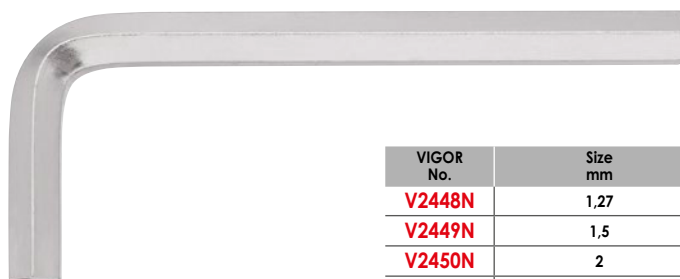

VIGOR No.	Size mm	mm	EAN 4047728+
V2448N	1,27	40	058070
V2449N	1,5	45,5	058087
V2450N	2	48	058094
V2451N	2,5	51	058100



V1409, EAN 4047728014090

6-point T-handle screwdriver set



Included



X	Design	Size mm
8 x		2 · 2.5 · 3 · 4 · 5 · 6 · 8 · 10

Hexagon T-handle screwdriver



VIGOR No.	Size mm	L1 mm	mm	EAN 4047728+
V2489	2	100	160	024891
V2486	2,5	100	160	024860
V2507	3	100	160	025072
V2506	4	100	160	025065
V2505	5	100	160	025058
V2504	6	132	217	025041
V2503	8	132	217	025034
V2502	10	132	217	025027

V1410, EAN 4047728014106

TORX® T-handle screwdriver set



Included



X	Design	Size mm
8 x		T9 · T10 · T15 · T20 · T25 · T27 · T30 · T40

TORX® T-handle screwdriver



VIGOR No.	Size mm	L1 mm	mm	EAN 4047728+
V2498	T9	100	160	024983
V2497	T10	100	160	024976
V2501	T15	100	160	025010
V2490	T20	100	160	024907
V2485	T25	100	160	024853
V2484	T27	132	217	024846
V2483	T30	132	217	024839
V2482	T40	132	217	024822

Screwdrivers and bits



V4199, EAN 4047728**041997**
Hex nut-driver set

6



2K System

X	Design	Size mm
6 x		6 · 7 · 8 · 10 · 12 · 13



Hex-nut driver



2K System

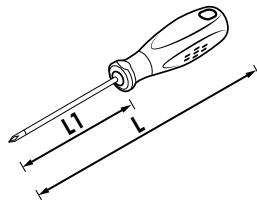

VIGOR No.	Size mm	L1 mm	EAN 4047728+
V4200	6	150	042000
V4221	7	150	042215
V4222	8	150	042222
V4223	10	150	042239
V4224	12	150	042246
V4225	13	150	042253

Bit screwdriver

6.3 1/4"

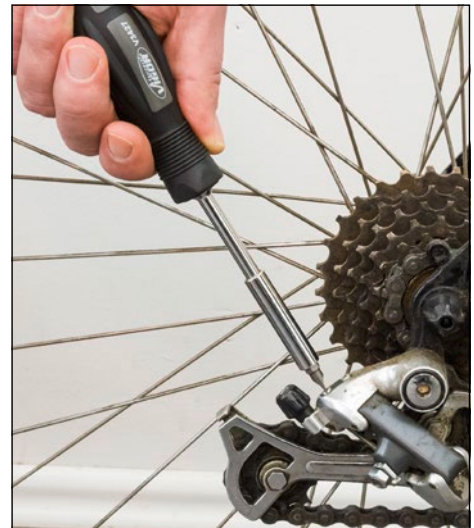

VIGOR No.	mm	EAN 4047728+
V3427N	200	058865





V5019, EAN 4047728**050197**

Bit box

• ~ DIN / ISO



X	■	■	Design	Size mm
4 x	6.3 1/4	+	PH 1 · PH 2 (2x) · PH 3	
4 x	6.3 1/4	+	PZ 1 · PZ 2 (2x) · PZ 3	
4 x	6.3 1/4	—	4 x 0,8 · 5 x 1 · 6,5 x 1,2 · 8 x 1,6 mm	
4 x	6.3 1/4	○	3 · 4 · 5 · 6 mm	
7 x	6.3 1/4	☆	T 10 · T 15 · T 20 · T 25 · T 27 · T 30 · T 40	
7 x	6.3 1/4	☆	T 10 H · T 15 H · T 20 H · T 25 H · T 27 H · T 30 H · T 40 H	
1 x	6.3 1/4	6.3 1/4	-	
1 x	6.3 1/4	6.3 1/4	60 mm	



32

V5502, EAN 4047728**055024**

Bit box

• Work with screws in the workshop, industry, trade, at home and for hobby use
• ~ DIN / ISO



X	■	■	Design	Size mm
4 x	6.3 1/4	+	PH 1 · PH 2 (2x) · PH 3	
4 x	6.3 1/4	+	PZ 1 · PZ 2 (2x) · PZ 3	
4 x	6.3 1/4	—	4 x 0,8 · 5 x 1 · 6,5 x 1,2 · 8 x 1,6 mm	
4 x	6.3 1/4	○	3 · 4 · 5 · 6 mm	
7 x	6.3 1/4	☆	T 10 · T 15 · T 20 · T 25 · T 27 · T 30 · T 40	
7 x	6.3 1/4	☆	T 10 H · T 15 H · T 20 H · T 25 H · T 27 H · T 30 H · T 40 H	
1 x	6.3 1/4	6.3 1/4	-	
1 x	6.3 1/4	6.3 1/4	-	



Including sales display for a purchase of at least 10 pieces



32



Screwdrivers and bits



V5020, EAN 4047728050203

Bit box

• ~ DIN / ISO

6.3 1/4" 6.3 1/4" 6.3 1/4"



57

			Design	Size mm
9 x				PH 1 (3x) · PH 2 (3x) · PH 3 (3x)
2 x				PH 1 · PH 2
9 x				PZ 1 (3x) · PZ 2 (3x) · PZ 3 (3x)
2 x				PZ 1 · PZ 2
6 x				4 x 0,8 (2x) · 5 x 1 (2x) · 6.5 x 1.2 · 8 x 1.6 mm
1 x				6.5 x 1.2 mm
3 x				4 · 5 · 6 mm
7 x				T 10 · T 15 (2x) · T 20 · T 25 · T 27 · T 30
2 x				T 15 · T 20
14 x				T 10 H (2x) · T 15 H (2x) · T 20 H (2x) · T 25 H (2x) · T 27 H (2x) · T 30 H (2x) · T 40 H (2x)
1 x				60 mm
1 x				-

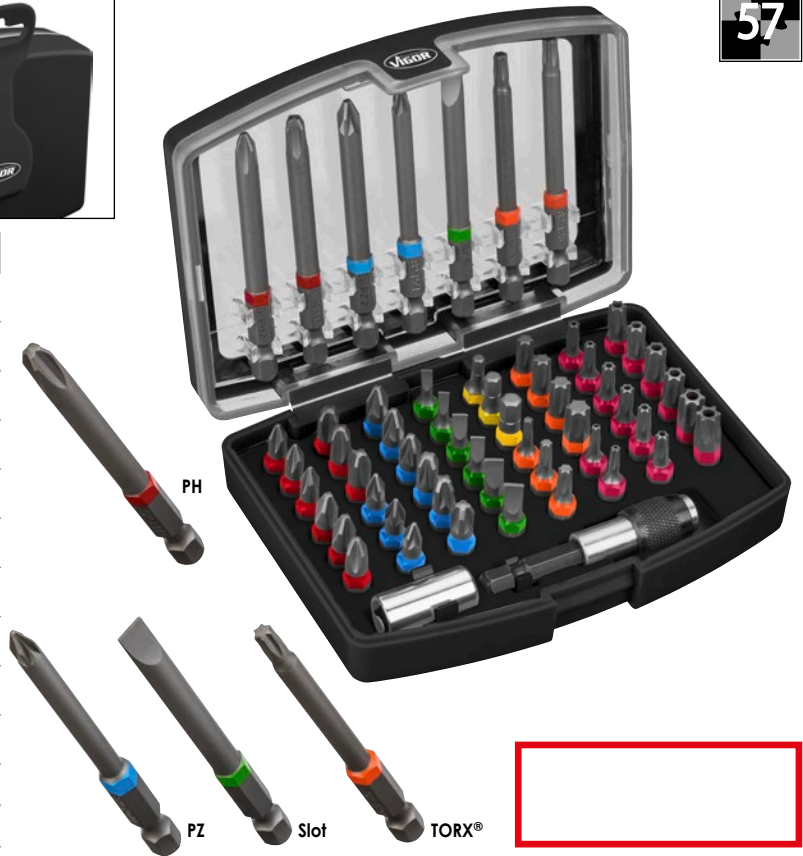

V6068, EAN 4047728060684

Bit box

• ~ DIN / ISO

6.3 1/4"

Including sales display for a purchase of at least 10 pieces



22

			Design	Size mm
7 x				T10 · T15 · T20 · T25 · T27 · T30 · T40
4 x				3 · 4 · 5 · 6
3 x			-	PH1 · PH2 · PH3
3 x			-	PZ1 · PZ2 · PZ3
4 x			-	3 · 4 · 5 · 6.5



V5650, EAN 4047728056502

Diagonal cutter with double joint

- Toothed, extremely slim design
- For working in areas with restricted access

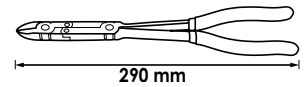
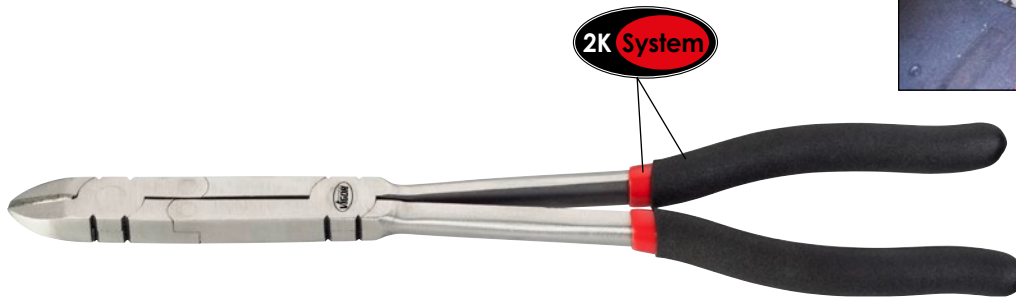

V2781, EAN 4047728027816

Combination pliers with double joint

- Toothed, extremely slim design
- For working in areas with restricted access

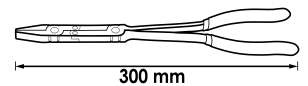
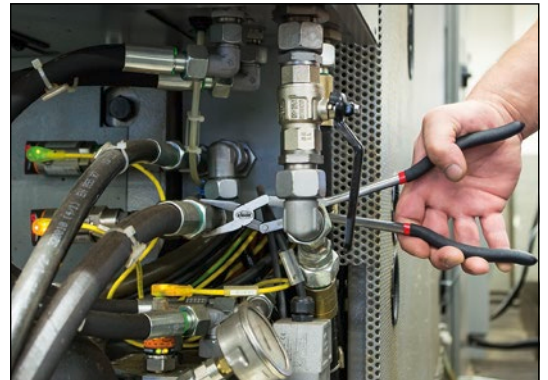

V2782, EAN 4047728027823

Snipe nose pliers with double joint

- Toothed, extremely slim design
- For working in areas with restricted access
- Curved design (45°)

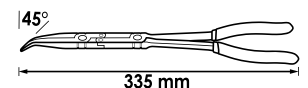

V2783, EAN 4047728027830

Snipe nose pliers with double joint

- Toothed, extremely slim design
- For working in areas with restricted access

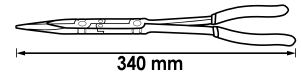

V5493, EAN 4047728054935

Spark plug pliers with double joint

- Installing and removing hard-to-reach spark plug sockets
- Also for severing fuel line connections
- 45° angled head

Safe application thanks to integrated teeth

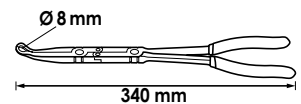

V5494, EAN 4047728054942

Spark plug pliers with double joint

- Installing and removing hard-to-reach spark plug sockets
- Also for severing fuel line connections
- 45° angled head

Safe application thanks to integrated teeth

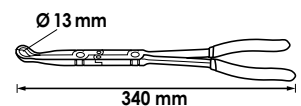

V5496, EAN 4047728054966

Circlip pliers with double joint, inside locking

- Inside lockrings (bore holes) 8 – 30 mm Ø
- Very simple tip replacement
- Tips colour coded
- Tip design / contents:
 - 2x Ø 1.0 mm straight
 - 2x Ø 1.0 mm 90° angled
 - 2x Ø 1.3 mm straight
 - 2x Ø 1.3 mm 90° angled
 - 2x Ø 1.8 mm straight
 - 1 x hexagon socket wrench

Double joint exponentially increases and transmits even the smallest of handle movements to the tips

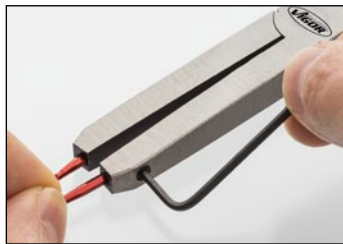
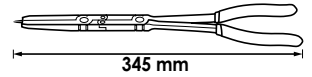

V5496-1, EAN 4047728054980

Replacement tip set for circlip pliers with double joint

- Circlip pliers with double joint V5496 · V5497
- Contents:
 - 2x Ø 1.0 mm straight
 - 2x Ø 1.0 mm 90° angled
 - 2x Ø 1.3 mm straight
 - 2x Ø 1.3 mm 90° angled
 - 2x Ø 1.8 mm straight
 - 1 x hexagon socket wrench



V5497, EAN 4047728054973

Circlip pliers with double joint, outside locking

- Outside lockrings (shafts) 12 – 30 mm Ø
- Very simple tip replacement
- Tips colour coded
- Tip design / contents:
 - 2x Ø 1.0 mm straight
 - 2x Ø 1.0 mm 90° angled
 - 2x Ø 1.3 mm straight
 - 2x Ø 1.3 mm 90° angled
 - 2x Ø 1.8 mm straight
 - 1 x hexagon socket wrench

Double joint exponentially increases and transmits even the smallest of handle movements to the tips

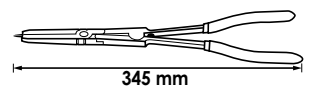

Pliers



V1616, EAN 4047728016162

Combination pliers

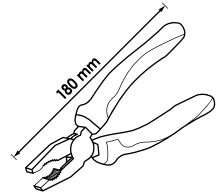
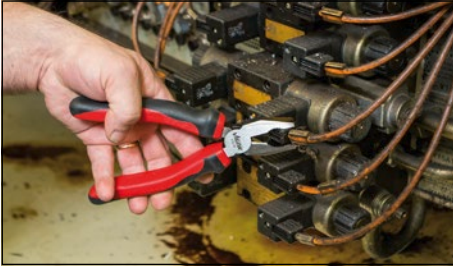

V1617, EAN 4047728016179

Diagonal cutter

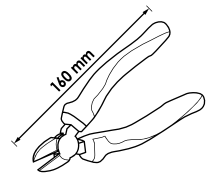

V2412, EAN 4047728024129

Snipe nose pliers

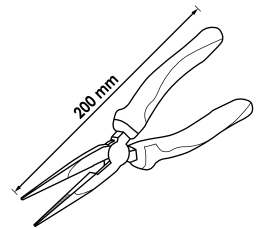

V4441, EAN 4047728044417

Circlip pliers set, 140 mm

- Contents:
 - Circlip pliers for inside lockrings V4427 (straight style) · V4428 (bent style)
 - Circlip pliers for outside lockrings V4429 (straight style) · V4430 (bent style)



V4442, EAN 4047728044424

Circlip pliers set, 180 mm

- Contents:
 - Circlip pliers for inside lockrings V1716 (straight style) · V1718 (bent style)
 - Circlip pliers for outside lockrings V1717 (straight style) · V1719 (bent style)



V4427, EAN 4047728**044271**

Circlip pliers

- Straight design (from C)
- For inside lockrings \varnothing 12–25 mm
- Tip diameter: 1.3 mm

1.3 mm

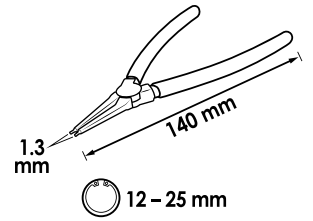

V4429, EAN 4047728**044295**

Circlip pliers

- Straight design (form A)
- For outside lockrings \varnothing 10–25 mm
- Tip diameter: 1.3 mm

1.3 mm

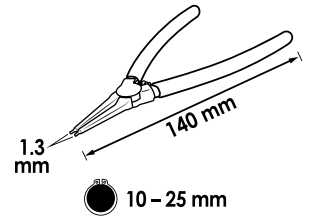
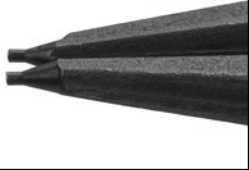

V4428, EAN 4047728**044288**

Circlip pliers

- Tips bent 90° (form D)
- For inside lockrings \varnothing 10–25 mm
- Tip diameter: 1.3 mm

1.3 mm

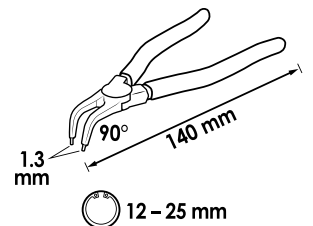

V4430, EAN 4047728**044301**

Circlip pliers

- Tips bent 90° (form B)
- For outside lockrings \varnothing 10–25 mm
- Tip diameter: 1.3 mm

1.3 mm

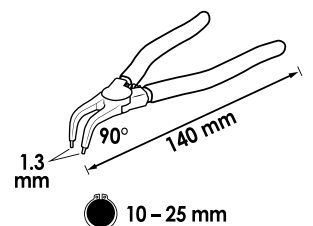
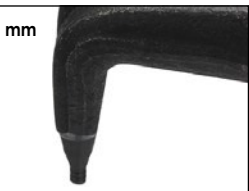

V1716, EAN 4047728017169

Circlip pliers

- Straight design (from C)
- For inside lockrings Ø 19-60 mm
- Tip diameter: 1.8 mm

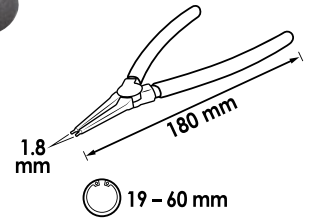
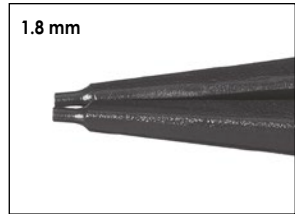

V1717, EAN 4047728017176

Circlip pliers

- Straight design (form A)
- For outside lockrings Ø 19-60 mm
- Tip diameter: 1.8 mm

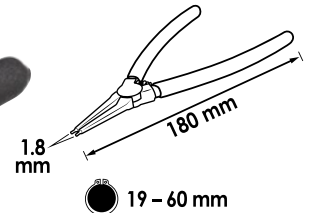
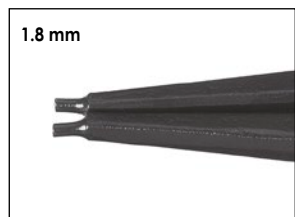

V1718, EAN 4047728017183

Circlip pliers

- Tips bent 90° (form D)
- For inside lockrings Ø 19-60 mm
- Tip diameter: 1.8 mm

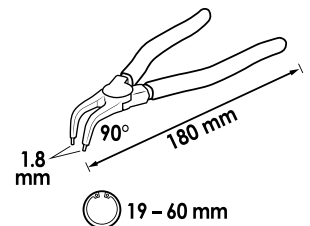
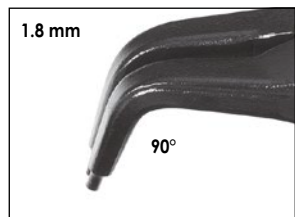

V1719, EAN 4047728017190

Circlip pliers

- Tips bent 90° (form B)
- For outside lockrings Ø 19-60 mm
- Tip diameter: 1.8 mm

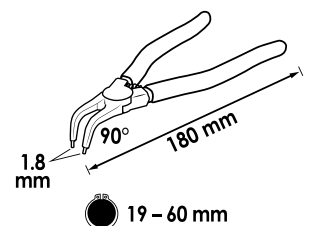
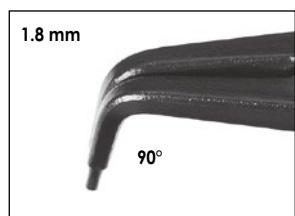

V2794, EAN 4047728**027946**

Circlip pliers

- DIN 5256 form C
- Straight design (form C)
- For inside lockrings Ø 40–100 mm
- Tip diameter: 2.3 mm

2.3 mm

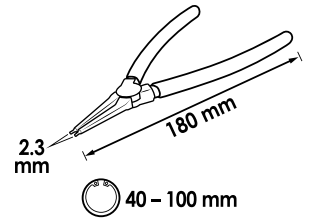

V2792, EAN 4047728**027922**

Circlip pliers

- DIN 5254 form A
- Straight design (form A)
- For outside lockrings Ø 40–100 mm
- Tip diameter: 2.3 mm

2.3 mm

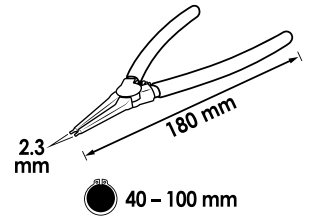

V2793, EAN 4047728**027939**

Circlip pliers

- DIN 5256 form D
- Tips bent 90° (form D)
- For inside lockrings Ø 40–100 mm
- Tip diameter: 2.3 mm

2.3 mm

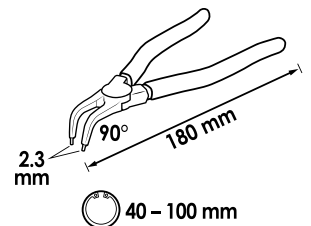
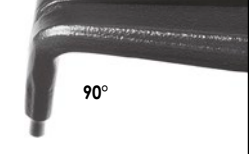

V2791, EAN 4047728**027915**

Circlip pliers

- DIN 5254 form B
- Tips bent 90° (form B)
- For outside lockrings Ø 40–100 mm
- Tip diameter: 2.3 mm

2.3 mm

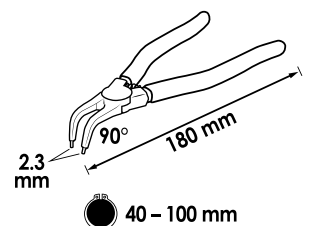

V3738-S, EAN 4047728069540

Grip pliers with curved jaws

- Safe gripping of nuts or screw heads
- Size adjustment with adjusting screw
- Locking element on handle
- Toothed inside of jaws
- Ergonomically shaped, easy to handle
- Chrome Molybdenum
- Nickel-plated
- Small design
- For areas with restricted access
- Wrench size 6–13 mm

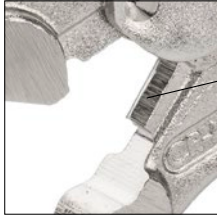
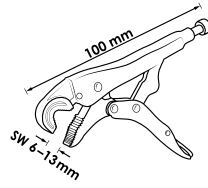

Wire cutter

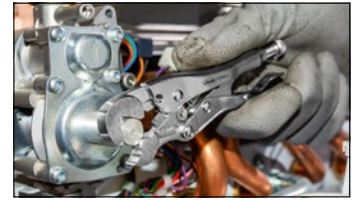

NEW



V3738, EAN 4047728037389

Grip pliers with curved jaws

- Safe gripping of nuts or screw heads
- Size adjustment with adjusting screw
- Locking element on handle
- Toothed inside of jaws
- Ergonomically shaped, easy to handle
- Chrome Molybdenum
- Nickel-plated

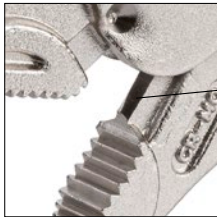
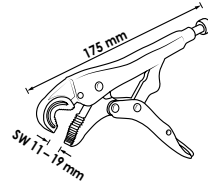

V3739, EAN 4047728037396

Grip pliers with curved jaws

- Safe gripping of nuts or screw heads
- Size adjustment with adjusting screw
- Locking element on handle
- Toothed inside of jaws
- Ergonomically shaped, easy to handle
- Chrome Molybdenum
- Nickel-plated

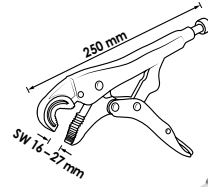

Wire cutter



V1808, EAN 4047728018081

Grip pliers set

- Size adjustment with adjusting screw
- Locking element on handle
- Toothed inside of jaws
- Ergonomically shaped, easy to handle
- Chrome Molybdenum
- Nickel-plated



Supplied in practical tool roll



VIGOR No.	Design	mm	EAN 4047728+
V1802		150	018029
V1803		250	018036
V1804		125	018043



V4637, EAN 4047728**046374**

Hose and spring band hose clamp pliers

- Operating hose and spring band hose clamp
- 590 mm long, reinforced bowden cable, including locking and inside spring
- Two-component handle / hardened steel
- Clamping range: 15–55 mm
- Thanks to its semi-flexible design also suitable for hard-to-reach self-gripping hose and spring band hose clamps



Semi-flexible bowden cable



V4637-1, EAN 4047728**050418**

Bowden cable for hose clamp pliers

- For hose clamp pliers V4637



V4196, EAN 4047728**041966**

Pliers for plastic rivets

41



Rubber handle

Metal die casting

Locking element

Narrow pliers head

Rivet head angled at 90 degrees

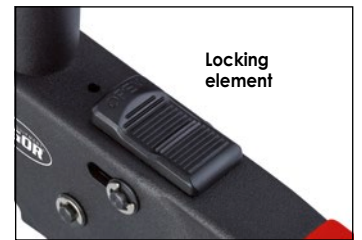

Including 40 plastic rivets



10 pieces:
17.2x6.6 mm



10 pieces:
17.2x5 mm



10 pieces:
15.8x5 mm



10 pieces:
25.2x6.3 mm

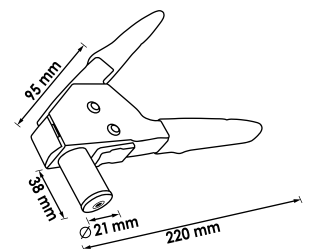

V5681, EAN 4047728056816

Electronic diagonal cutter

- For wire classes:
 - Soft up to \varnothing 1.6 mm
 - Medium-hard up to \varnothing 1.2 mm
 - Hard up to \varnothing 0.8 mm



ESD version

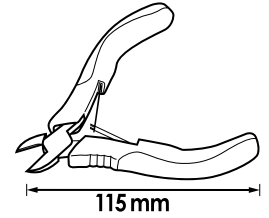
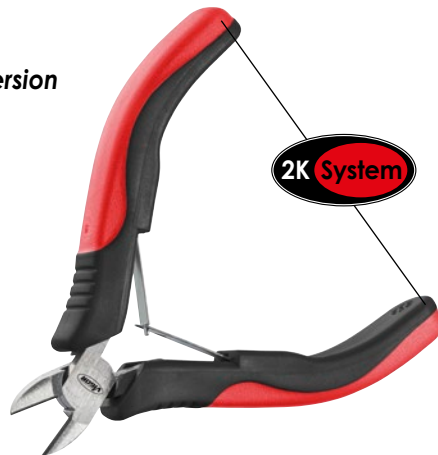

V1426N, EAN 4047728064392

Universal pliers

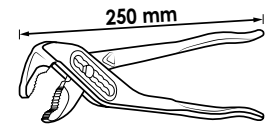

V5630, EAN 4047728056304

Universal pliers

- Handle with plastic cover
- Highest stability of the slip joint due to double guide
- Clamping protection prevents crushing injuries in case of uncontrolled application
- Inner gripping areas with special hardened tothing offers non-skidding grip on the workpiece
- Pliers individually tempered and hardened

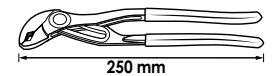
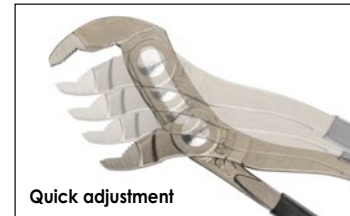

V1785, EAN 4047728017855

Multi-tool 14 in 1

Included



V3735, EAN 4047728037358

Hand riveting tool for blind rivets and rivet nuts, universal

- Rivet nuts: M5 · M6 · M8 · M10 for rivets made of copper, brass, steel and stainless steel
- Blind rivets: 3.2 · 4.0 · 4.8 · 6.4 mm for rivets made of copper, brass, steel and stainless steel

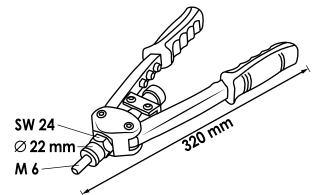

Spare parts

VIGOR No.	Designation	EAN 4047728+
V3735-3.2	Mouthpiece for blind rivets 3.2 mm	053976
V3735-4.0	Mouthpiece for blind rivets 4.0 mm	053617
V3735-4.8	Mouthpiece for blind rivets 4.8 mm	053624
V3735-6.4	Mouthpiece for blind rivets 6.4 mm	053631

VIGOR No.	Designation	EAN 4047728+
V3735-M5	Mouthpiece for rivet nuts M5	053495
V3735-M6	Mouthpiece for rivet nuts M6	053501
V3735-M8	Mouthpiece for rivet nuts M8	053518
V3735-M10	Mouthpiece for rivet nuts M10	053525

V2788, EAN 4047728027885

Blind rivet pliers

- For blind rivets: 3.2 · 4.0 · 4.8 · 6.4 mm
- For rivets made of copper, brass, steel and stainless steel
- Very low power required, extra short design

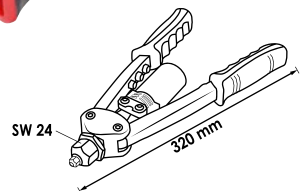

Spare parts

VIGOR No.	Designation	EAN 4047728+
V2788-3.2	Mouthpiece for blind rivets 3.2 mm	053648
V2788-4.0	Mouthpiece for blind rivets 4.0 mm	053655
V2788-4.8	Mouthpiece for blind rivets 4.8 mm	053662
V2788-6.4	Mouthpiece for blind rivets 6.4 mm	053679



Pliers



V6799, EAN 4047728067997

Flexible hose clamp set

- Disconnecting flexible hose lines
- Secure, adjustable latching
- Maintenance work with petrol, radiator antifreeze, oil, etc.
- Temperature resistance up to 220 °C

NEW



	L mm
①	250
②	190
③	160



V3343, EAN 4047728033435

VDE socket set

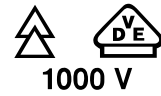

Single parts see page 217

X	■	●	Design	Size mm
9 x	125 1/2	●		8 · 10 · 12 · 13 · 14 · 17 · 19 · 22 · 24
3 x	125 1/2	○		5 · 6 · 8
1 x	125 1/2	125 1/2		125 mm
1 x	-	125 1/2		255 mm



VDE reversible ratchet

12⁵ 1/2"



VIGOR No.	mm	EAN 4047728+
V3342	255	033428

VDE extension

12⁵ 1/2" 12⁵ 1/2"

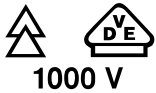

VIGOR No.	mm	EAN 4047728+
V3341	125	033411

VDE socket

12⁵ 1/2"

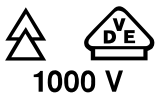

VIGOR No.	Size mm	mm	EAN 4047728+
V3330	8	55	033305
V3331	10	55	033312
V3332	12	55	033329
V3333	13	55	033336
V3334	14	55	033343
V3335	17	55	033350
V3336	19	55	033367
V3337	22	55	033374
V3338	24	55	033381

VDE screwdriver socket

12⁵ 1/2"



VIGOR No.	Size mm	mm	EAN 4047728+
V3339	5	78	033398
V3344	6	78	033442
V3340	8	78	033404



V2027, EAN 4047728020275

VDE screwdriver set

• Manufactured according to DIN/ISO



X	Design	Size mm
4 x		0,5x3 · 0,8x4 · 1x5,5 · 1,2x6,5
3 x		PH0 · PH1 · PH2



VDE screwdriver for slotted screws

• Manufactured according to DIN/ISO

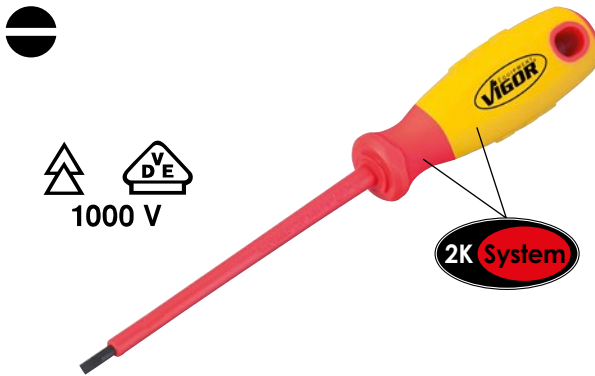
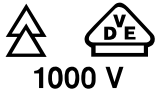

VIGOR No.	Size mm	L1 mm	L mm	EAN 4047728+
V2028	0,5x3	100	181	020282
V2029	0,8x4	100	181	020299
V2030	1x5,5	125	231	020305
V2061	1,2x6,5	150	256	020619

VDE Phillips-Recess screwdriver

• Manufactured according to DIN/ISO

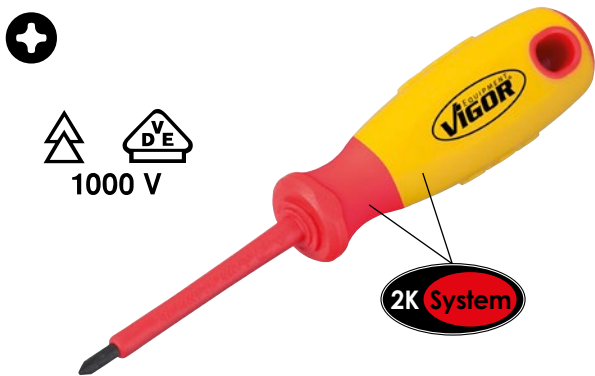
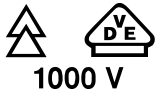

VIGOR No.	Size mm	L1 mm	L mm	EAN 4047728+
V2062	PH0	60	141	020626
V2063	PH1	80	161	020633
V2064	PH2	100	206	020640

V1138, EAN 4047728011389

Voltmeter

• 150 up to 250 V, VDE-tested
 • 220 up to 250 V according to VDE 0680
 • 3x0.5x140 mm

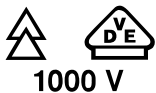

V2641, EAN 4047728026413

VDE round nose pliers

- Long jaws
- Length: 160 mm



V2628, EAN 4047728026284

VDE combination pliers

- Length: 180 mm



V2629, EAN 4047728026291

VDE diagonal cutter

- For hard wire (H)
- Length: 160 mm

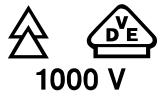
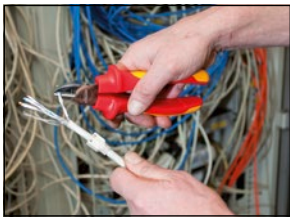

V2630, EAN 4047728026307

VDE snipe nose pliers

- Cutting edge
- Length: 200 mm

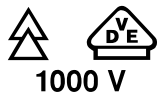

V2643, EAN 4047728026437

VDE wire stripper

- Spring and adjusting screw
- Length: 160 mm



Machinist's hammer

- Ash stick



VIGOR No.	— L — mm	⚖ g	EAN 4047728+
V1135	300	300 g	011358
V2662	320	500 g	026628
V2665	350	800 g	026659
V2664	360	1000 g	026642
V2663	400	2000 g	026635

Club hammer

- Ash stick



VIGOR No.	— L — mm	⚖ g	EAN 4047728+
V4234	260	1000 g	042345
V4235	280	1500 g	042352
V4236	300	2000 g	042369

V1212, EAN 4047728012126

Plastic soft-faced hammer

- Replaceable heads made from impact-resistant cellulose acetate
- Ash stick
- Length: 280 mm
- Ø 32 mm



V3541, EAN 4047728035415

Spare head (pair)

- Spare head (pair) for plastic soft-faced hammer V1212



V4661, EAN 4047728046619

Plastic soft-faced hammer

- Replaceable heads made from impact-resistant cellulose acetate
- Ash stick
- Length: 320 mm
- Ø 40 mm



V4661-1, EAN 4047728048514

Spare heads (pair)

- Spare head (pair) for plastic soft-faced hammer V4661



V1221, EAN 4047728012218
Flat chisel

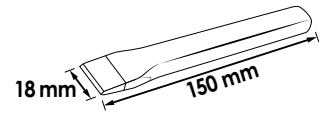

V1222, EAN 4047728012225
Cape chisel

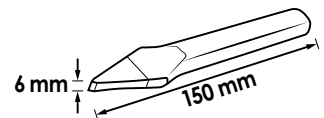

V1220, EAN 4047728012201
Centre punch

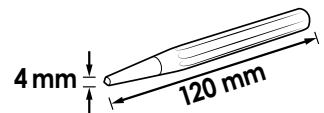

V1783, EAN 4047728017831
Centre punch, self-punching

- The impact force is applied by simply pressing down the upper part



Progressively adjustable



Drift pin



VIGOR No.	∅ mm	mm	EAN 4047728+
V1214	2	150	012140
V1215	3	150	012157
V1216	4	150	012164
V1217	5	150	012171
V1218	6	150	012188
V1219	8	150	012195



V1283, EAN 4047728012836

Set of gasket scrapers

- Removing sealing residues on cylinder head lid, valve cover, carburetor cover gaskets, etc.
- Stainless steel blades
- Hanging hole
- Set of 4 pieces

VIGOR No.	L1 mm	L2 mm	Blade width mm	Blade height mm	EAN 4047728+
V2487	105	230	32	1,2	024877
V2488	105	230	32	2,5	024884
V2509	55	175	20	1,2	025096
V2508	55	175	20	2,5	025089



V1368, EAN 4047728013680

Vignette scraper

- Removing vignettes, badges and stickers. Suitable also for ceramic glass cooktop, window, etc.
- Blades can be replaced quickly and safely
- One blade included

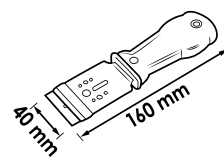

V1372, EAN 4047728013727

Spare blades



10

V1213, EAN 4047728012133

Gasket scraper, long

- Removing sealing residues on cylinder head lid, valve cover, carburetor cover gaskets, etc.
- Long design
- Plastic handle

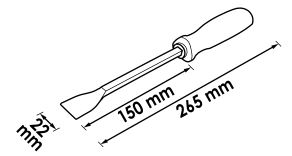

V4663, EAN 4047728046633

Mini hook set

- Inserting and removing O-rings or seals
- Also for removing the protection caps on wheel bolts
- Hanging hole
- Short design

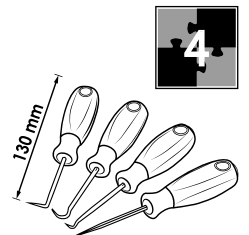

V5045, EAN 4047728050456

Hook and scraper set

- Removing and inserting O-rings and seals and for removing stickers and the remains of seals and adhesive
- Also for removing the protection caps on wheel bolts
- With hanging hole

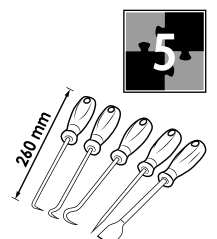

V6200, EAN 4047728061940

Drift pin set

- Ergonomically 2-component handle
- Safe gripping
- Significantly reduced risk of injury thanks to hand guard
- Reduced vibrations when hitting
- Elongated impact cap
- 7 different sizes (driving mandrel \varnothing 2 – 8 mm)
- Storage in practical tool roll

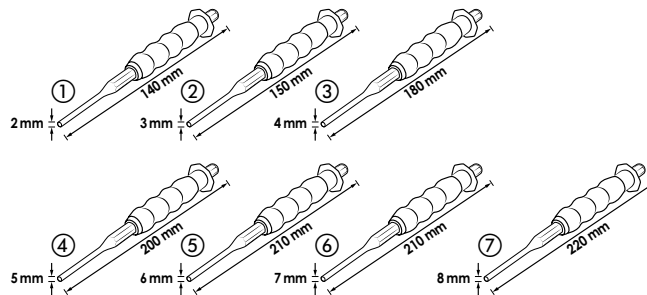

	VIGOR No.	EAN 4047728+
①	V6200-2	061957
②	V6200-3	061964
③	V6200-4	061971
④	V6200-5	061988
⑤	V6200-6	061995
⑥	V6200-7	062008
⑦	V6200-8	062015



V6220/4, EAN 4047728066006

Flat chisel set

- Safe, easy disconnection of components or parts
- Ergonomic two-component handle
- Safe gripping
- Reduced vibrations when hitting
- Elongated impact cap
- 4 different sizes: 10 · 16 · 20 · 29 mm
- Storage in practical tool roll

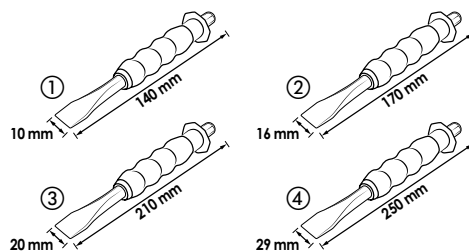

	VIGOR No.	EAN 4047728+
①	V6220-10	065955
②	V6220-16	065962
③	V6220-20	065979
④	V6220-29	063890



V6210-4, EAN 4047728065948

Centre punch

- Labelling of components to be processed
- Ergonomic two-component handle
- Safe gripping
- Reduced vibrations when hitting
- Elongated impact cap
- Tip \varnothing 4 mm
- Centre punch 4x10x185 mm



NEW

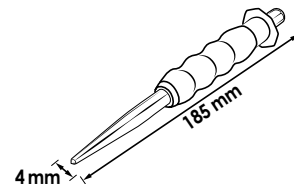

V6210-10, EAN 4047728065931

Centre punch

- Labelling of components to be processed
- Ergonomic two-component handle
- Safe gripping
- Reduced vibrations when hitting
- Elongated impact cap
- Tip \varnothing 10 mm
- Centre punch 10x12x185 mm



NEW

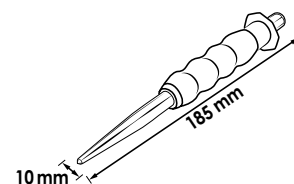

V6230-5, EAN 4047728065986

Cape chisel

- Safe, easy disconnection of components or parts
- Ergonomic two-component handle
- Safe gripping
- Reduced vibrations when hitting
- Elongated impact cap
- Blade width: 5 mm
- Cape chisel 5x10x170 mm



NEW

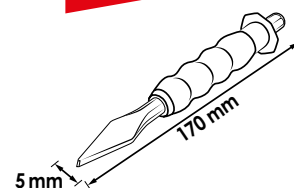

V6230-7, EAN 4047728065993

Cape chisel

- Safe, easy disconnection of components or parts
- Ergonomic two-component handle
- Safe gripping
- Reduced vibrations when hitting
- Elongated impact cap
- Blade width: 7 mm
- Cape chisel 7x12x190 mm



NEW

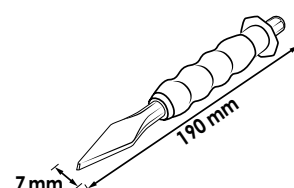

V6030, EAN 4047728060301

Scraper set

- Removing badges, stickers, vignettes or adhesive residue, among other things
- Further application fields: removal of motor seals, e.g. on the cylinder head or valve cover
- Blades can be easily replaced by loosening the screw connection on the chuck
- Different blades enable adaptation to different application fields



	VIGOR No.	Designation	Blade width mm	EAN 4047728+
①	V6030-12	Spare blades	12	062121
②	V6030-16	Spare blades	16	062138
③	V6030-20	Spare blades	20	062145

V1371, EAN 4047728069687

Removal lever set, 11 pieces

- Ideal for working on door panels, dashboards, rubber seals, decorative strips, etc.
- Does not cause scratches
- Slim and robust design
- Versatile in use in workshop or household

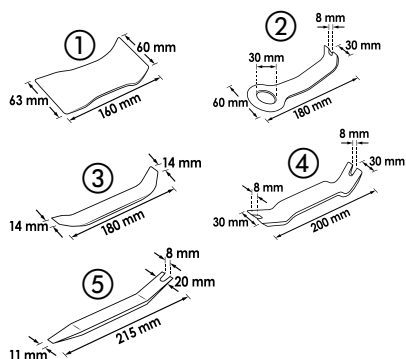

NEW



	VIGOR No.	EAN 4047728+
①	V1371-1	069649
②	V1371-2	069700
③	V1371-3	069656
④	V1371-4	069694
⑤	V1371-5	069670
⑥	V1371-6	069632
⑦	V2491	024914
⑧	V2492	024921
⑨	V2493	024938
⑩	V2494	024945
⑪	V2495	024952

In practical tool roll



V1369, EAN 4047728013697

Removal lever set

- Ideal for working on door panels, dashboards, rubber seals, decorative strips, etc.
- Does not cause scratches
- Slim and robust design
- Versatile in use in workshop or household



VIGOR No.	L mm	Blade width mm	EAN 4047728+
V2491	160	60	024914
V2492	180	30	024921
V2493	180	20	024938
V2494	200	30	024945
V2495	210	20	024952

V4885, EAN 4047728048859

Clip loosening set

- Metal and plastic clips of vehicle trims
- Hanging hole
- Length: 330 mm

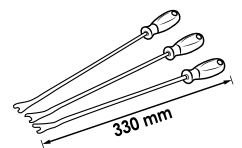

V4310N, EAN 4047728062817

Release lever

- Slim design – for working in areas that are difficult to access e.g. for removing the plastic clips from door and tailgate trims
- Length: 165 mm



Plastic sleeve for damage-free work



NEW

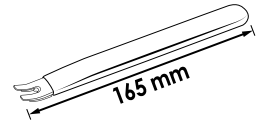

V1301, EAN 4047728013017

Pry bar set

- Impact-resistant handle
- Lengths: 600 mm, 450 mm, 300 mm, 200 mm

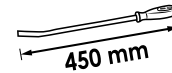
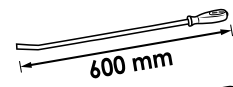

V6952, EAN 4047728069526

Mini removal lever set

- Ideal for replacing the batteries in car keys or working on the dashboard
- Work on lacquered areas without scratches
- Small and versatile in use, e.g. for smartphone displays
- High-quality plastic

Work on lacquered areas without scratches!

L (mm)
1 190
2 185
3 185
4 165
5 170
6 170



NEW



V5591, EAN 4047728055918

Tape measure

- Determining short distances up to 5 m accurate to the millimetre
- Length: 5 m, width: 19 mm
- Wrist strap and belt clip
- Magnetic stopper
- Hand-regulated belt feed and belt stop
- Stable spring band steel



V1714, EAN 4047728017145

Feeler gauge set

- Precise testing of gap dimensions, contact gaps, hollow spaces
- With locknut
- Sheets conically shaped
- 20 sheets
- 0.05–1.00 mm

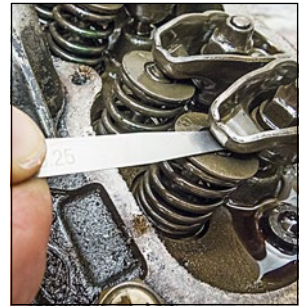

V4690, EAN 4047728046909

Vernier calliper, analogue

- External and internal measurements in the 0–150 mm range
- Millimetre and inch increments
- Nonius 0.05 mm and $\frac{1}{128}$ "
- Fixing screw
- Dipstick
- In plastic box
- Length: 235 mm
- DIN 862



V1713, EAN 4047728017138

Vernier calliper, digital

- External and internal measurements in the 0–150 mm range
- Millimetre and inch increments
- Digital display
- 1.5 V (LR 44) – 180 mAh
- Fixing screw
- Dipstick
- In plastic box
- Length: 235 mm



Can be switched between mm / inches



V1304, EAN 4047728013048

Universal scissors

- Long, high-quality cutting edges
- Stainless steel blade

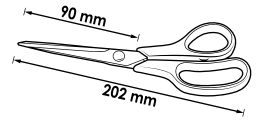

V2790, EAN 4047728027908

Hack saw, small

- Standard saw blades

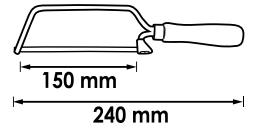

V1715, EAN 4047728017152

Saw frame

- Standard saw blades

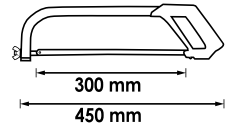

V4651, EAN 4047728**046510**

Jack-knife, outdoor

- Blade length: 86 mm
- Total length: 185 mm
- Stainless steel blade
- Aluminium grip housing

With locking element

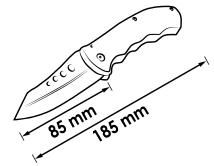

V2627, EAN 4047728**026277**

Universal knife

Snap-off blade: 9 mm

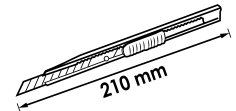

V4308, EAN 4047728**043083**

Snap-off blades, 9 mm

- Each snap-off blade consists of 12 individual blades, which can be easily separated after wearing down
- For cutter V2627

10



V4275, EAN 4047728**042758**

Universal knife

- Steel-guided blade fixed for minimising accidents
- Quick-change magazine
- Includes 6 snap-off blades (V4274)

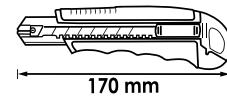

7



Anti-slip convenient handle

V4274, EAN 4047728**042741**

Snap-off blades, 18 mm

- Blades consist of eight individual blades, which can be easily separated after wearing down
- For universal knife V4275

10



V1345, EAN 4047728**013451**

Universal knife

- Aluminium housing
- Quick-change magazine
- Includes 10 trapezoid blades (V1446)



11



V1446, EAN 4047728**014465**

Trapezoid blades

- Can be used in two different ways due to trapezoidal shape
- For universal knife V1345

10



V1787, EAN 4047728017879

Flat hand file

- Teeth (cut): 2 = medium
- DIN 7261

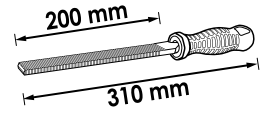

V1788, EAN 4047728017886

Three square file

- Teeth (cut): 2 = medium
- DIN 7261

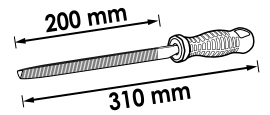

V1789, EAN 4047728017893

Square file

- Teeth (cut): 2 = medium
- DIN 7261

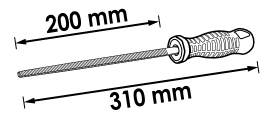

V1790, EAN 4047728017909

Half-round file

- Teeth (cut): 2 = medium
- DIN 7261

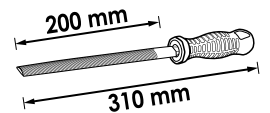

V1801, EAN 4047728018012

Round file

- Teeth (cut): 2 = medium
- DIN 7261

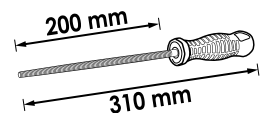

V6809-4, EAN 4047728067720

Steel wire brush, 4 rows

- Steel working
- Steel bristles
- Wire: 0.30 mm



NEW



V6807-4, EAN 4047728067713

Brass wire brush, 4 rows

- Gentle handling of sensitive surfaces
- Brass bristles
- Wire: 0.30 mm



NEW



V2654, EAN 4047728026543

Wire brush, stainless steel

- Working sheet metal made of V2A and aluminium
- V2A bristles



V6800-50, EAN 4047728067621

Cup brush, coarse

- Removal of coarse sediments and residues as well as stubborn rust
- Steel wire
- 6 mm clamping shaft
- Maximum 4500 rpm
- 50 mm Ø
- Trim size: 17 mm



NEW

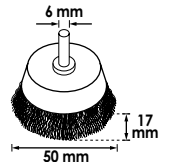

V6800-75, EAN 4047728067638

Cup brush, coarse

- Removal of coarse sediments and residues as well as stubborn rust
- Steel wire
- 6 mm clamping shaft
- Maximum 4500 rpm
- 75 mm Ø
- Trim size: 20 mm



NEW

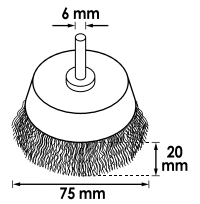

V6802, EAN 4047728067645

Wire end brush

- Deburring, paint removal, rust removal and cleaning
- Steel wire
- 25 mm Ø
- 6 mm clamping shaft
- Maximum 4500 rpm



NEW

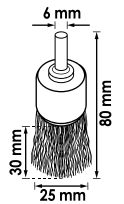

V6803-75, EAN 4047728067652

Wheel brush

- Removal of tempered colour on weld seams
- Steel wire
- 6 mm clamping shaft
- Maximum 4500 rpm
- 75 mm Ø



NEW

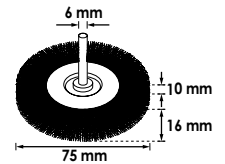

V6803-100, EAN 4047728067669

Wheel brush

- Removal of tempered colour on weld seams
- Steel wire
- 6 mm clamping shaft
- Maximum 4500 rpm
- 100 mm Ø



NEW

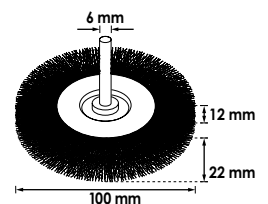

V6806, EAN 4047728067676

Wheel brush, coarse

- Removal of coarse sediments and residues as well as stubborn rust or scaling
- Steel wire
- Design with knotted wire
- 75 mm Ø
- Maximum 12500 rpm



NEW

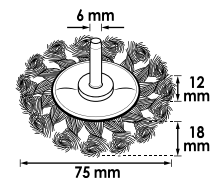

V6801-65, EAN 4047728067683

Cup brush

- Heavy brushing on large surfaces as well as for deburring, derusting and cleaning
- Steel wire
- Design with knotted wire
- 65 mm Ø
- Thread: M14x2.0
- Maximum 12500 rpm



NEW

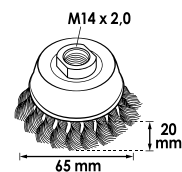

V6804, EAN 4047728067690

Wheel brush

- Deburring, paint removal, rust removal and cleaning
- Hardened steel wire
- Design with knotted wire
- 65 mm Ø
- Thread: M14x2.0
- Maximum 12500 rpm



NEW

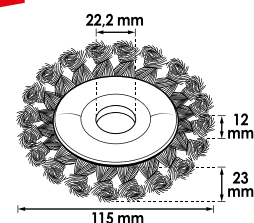

V6805, EAN 4047728067706

Bevel brush

- Cone-shaped for hard-to-reach areas
- Hardened steel wire
- Design with knotted wire
- 100 mm Ø
- Thread: M14x2.0
- Maximum 12500 rpm



NEW

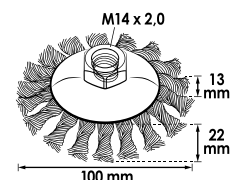

V6917, EAN 4047728069175

Brake line ratcheting tube cutter

- Space-saving ratcheting tube cutter for 4.75 mm brake lines
- Ratcheting mechanism in the head of the tool minimises space required – can be used directly on the vehicle
- No readjustment of the cutting wheel due to self-adjustment
- Faster cutting result than conventional line cutters
- Adjustment of the self-adjusting cutting force possible
- Spare blades V6917-REP

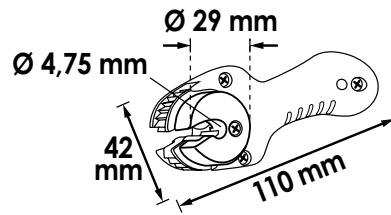

V6917-REP, EAN 4047728069199

Spare cutter wheel for brake line ratcheting tube cutter V6917



NEW

Self-adjusting



V2626, EAN 4047728026260

Tube cutter

- For tubes made of copper, brass, light metal and PVC rigid

Ø 3 – 16 mm



V3309, EAN 4047728033091

Ratcheting exhaust pipe cutter

- For cutting stainless steel, steel, copper and aluminium
- Ratchet function:
 - allows you to work in areas with restricted access
 - means it is not necessary to guide the cutting handle pipe
- Working range: 32–67 mm
- Cutting depth: 3 mm



V3451, EAN 4047728034517

Spare blades

- Spare blades for ratcheting tube cutter V3309



V1707, EAN 4047728017077

HSS step drill set



VIGOR No.	Ø mm	EAN 4047728+
V2394	4–12	023948
V2395	4–20	023955
V2396	4–30	023962



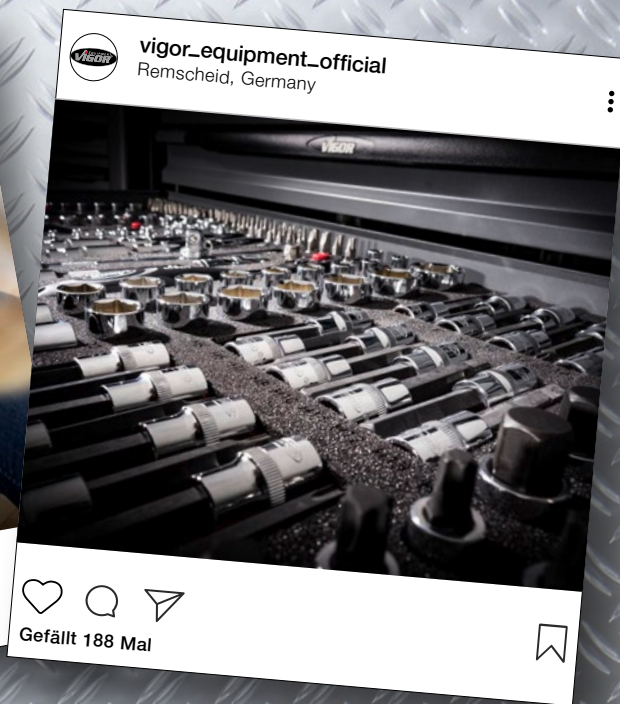

Follow us on

Instagram



For the latest news on our products, "behind the scenes", trade fairs and competitions.

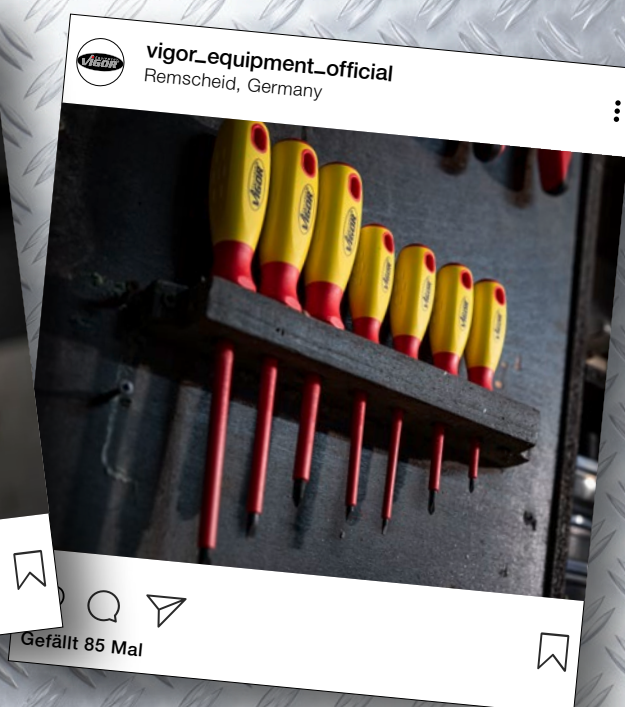





VIGOR Torque tools

T-handle torque screwdriver

238

Torque wrenches

239–240

Rotation angle tester

241



V4431-2, EAN 4047728044332

T-handle torque screwdriver

- Torque release: palpable and audible
- Slipper wrench with overload clutch → no over-tightening
- Tighten clockwise only → no loosening of screw connections
- For screw connections in tyre pressure control systems (TPCS)
- DIN EN ISO 6789-2:2017, DIN 3120, ISO 1174-1A



0.2 – 2 Nm

6.3 1/4"



V4431-1, EAN 4047728044325

T-handle torque screwdriver

- Torque release: palpable and audible
- Slipper wrench with overload clutch → no over-tightening
- Tighten clockwise only → no loosening of screw connections
- For screw connections in tyre pressure control systems (TPCS)
- DIN EN ISO 6789-2:2017, DIN 3120, ISO 1174-1A



2 – 10 Nm

6.3 1/4"



V3898, EAN 4047728**038980**

Torque wrench

- Torque release: palpable and audible
- Release accuracy tolerance $\pm 4\%$ of scale value (in direction of actuation)
- With serial number and certificate
- DIN EN ISO 6789-2:2017, DIN 3120, ISO 1174-1A



20–120 Nm

Scale graduation: 1 Nm

445 mm

12⁵ 1/2 72 15°

Fine-tooth reversible ratchet

12⁵ 1/2

Double scale: Nm and lbf.ft.

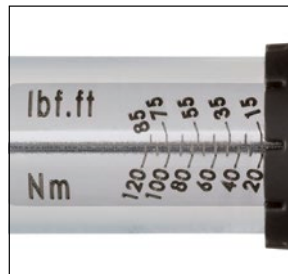

Handle with suspension lug



V3441, EAN 4047728034418

Torque wrench

- Torque release: palpable and audible
- Release accuracy tolerance $\pm 4\%$ of scale value (in direction of actuation)
- With serial number and certificate
- DIN EN ISO 6789-2:2017, DIN 3120, ISO 1174-1A



Scale graduation: 1 Nm

40–200 Nm

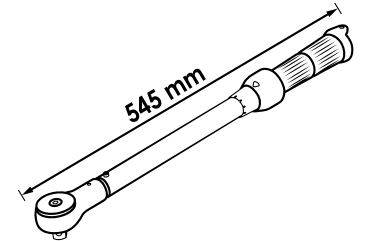
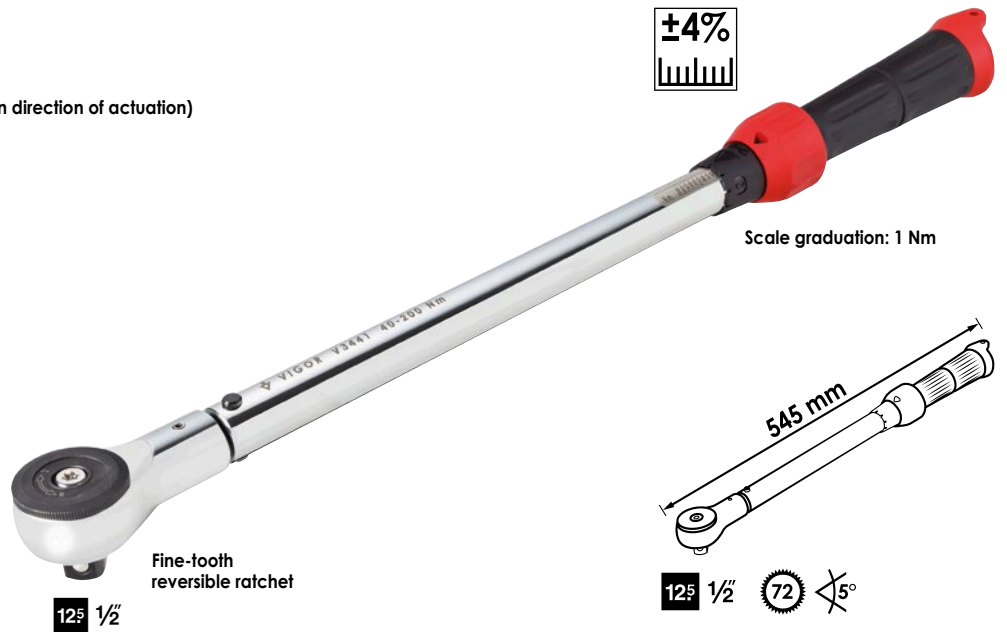

Fine-tooth reversible ratchet

12 5/8"

Double scale: Nm and lbf.ft.

Handle with suspension lug

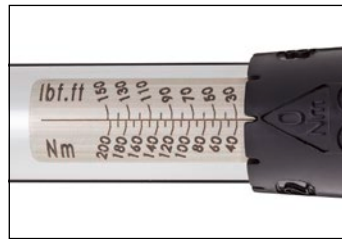

V3899, EAN 4047728038997

Torque wrench

- Torque release: palpable and audible
- Release accuracy tolerance $\pm 4\%$ of scale value (in direction of actuation)
- With serial number and certificate
- DIN EN ISO 6789-2:2017, DIN 3120, ISO 1174-1A



Scale graduation: 1 Nm

60–320 Nm

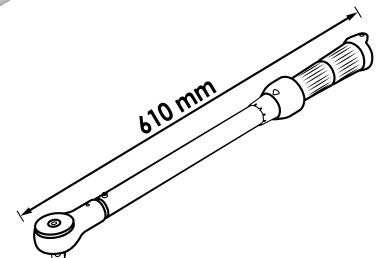

Fine-tooth reversible ratchet

12 5/8"

Double scale: Nm and lbf.ft.

Handle with suspension lug

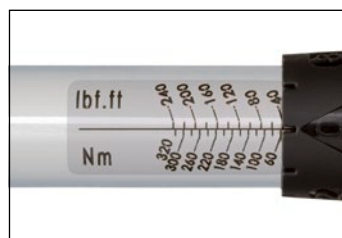

Rotation angle tester

EQUIPMENT
VIGOR

V2795, EAN 4047728027953

Rotation angle tester

- Fine resolution (0.1°)
- Rotation angle range up to 999° (adding)
- Angle measurement in clockwise and anti-clockwise direction
- Memory capacity up to 99 readings
- Indication of battery charge
- LED alarm indication (flashing)
- Buzzer alarm indication
- Audible alarm signal
- Automatic switch-off function





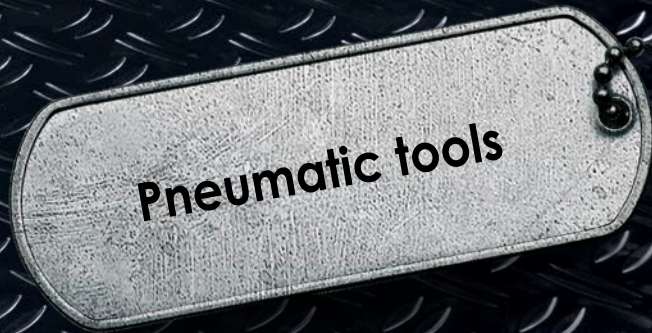

Impact wrenches	244-245
Air ratchets	246
Die grinder	247
Sanders / Drills	248
Pneumatic guns	249



V5671, EAN 4047728056717

Mini impact wrench

- Compact design for areas with restricted access
- Multiple power settings in forward and reverse with one-hand adjustment
- Exhaust air is guided downwards through the handle
- Cold insulated handle
- High performance single hammer striking mechanism
- Ergonomically shaped handle and housing for improved handling and operation

MINI GIANT



12⁵ 1/2

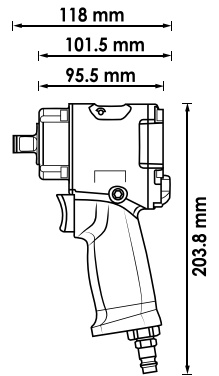

kg
1.45

Max. loosening torque: 1000 Nm

Multiple power settings in forward and reverse with one-hand reversing switch



Comparison V5671 with V4800



12.91 (w) 7.2

Coupler plug included

Single hammer striking mechanism

	mm	Nm	Nm	Nm	1/min.	Ø mm	l/min	bar	dB(A)	m/s ²
	12 ⁵ 1/2	474	610	1000	8.500	10	141.5	6.3	Lp A 94.6	5.99

V4800, EAN 4047728047104

Impact wrench

- Exhaust air is guided downwards through the handle
- Cold insulated handle
- High performance twin hammer mechanism
- Ergonomically shaped handle and housing for improved handling and operation

ECO GIANT



12⁵ 1/2

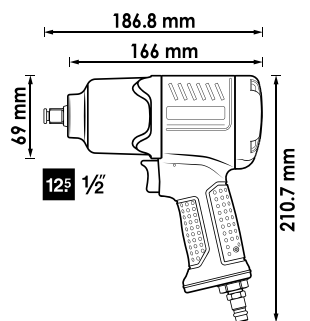

kg
2.1

Max. loosening torque: 1200 Nm

Multiple power settings in forward



12.91 (w) 7.2

Coupler plug included

High performance twin hammer mechanism

	mm	Nm	Nm	Nm	1/min.	Ø mm	l/min	bar	dB(A)	m/s ²
	12 ⁵ 1/2	550	610	1200	7.500	10	183.9	6.3	Lp A 107.4	7.76

Impact wrenches

EQUIPMENT
VIGOR

V3653, EAN 4047728036535

Impact wrench

- Multiple power settings in forward and reverse with one-hand adjustment
- Exhaust air is guided downwards through the handle
- Cold insulated handle
- High performance twin hammer mechanism
- Ergonomically shaped handle and housing for improved handling and operation

Max. loosening torque: 1890 Nm

GIGAGIANT



12⁵ 1/2"



Multiple power settings in forward and reverse with one-hand reversing switch



kg
2.0

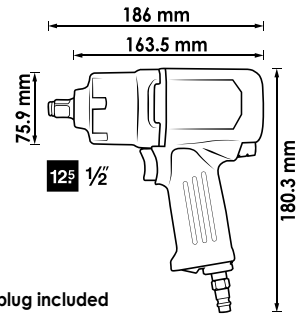

Coupler plug included

12.91 (6) 7.2

High performance twin hammer mechanism

	mm	Nm	Nm	Nm	1/min.	Ø mm	l/min	bar	dB(A)	m/s ²
	12 ⁵ 1/2"	700	1290	1890	8000	10	142	6.3	Lp A 118.2	13.2

V6899, EAN 4047728068994

Impact wrench

- Multiple power settings in forward and reverse with one-hand adjustment
- Cold insulated handle
- Exhaust air is guided downwards through the handle
- High performance twin hammer mechanism
- Ergonomically shaped handle and housing for improved handling and operation

Max. loosening torque: 1890 Nm

GIGAGIANT



20 3/4"



Multiple power settings in forward and reverse with one-hand reversing switch



kg
2.2

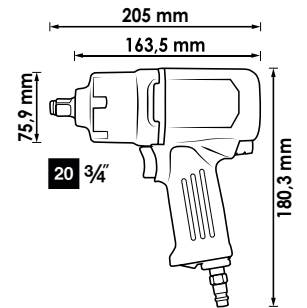

Coupler plug included

12.91 (6) 7.2

High performance twin hammer mechanism

	mm	Nm	Nm	Nm	1/min.	Ø mm	l/min	bar	dB(A)	m/s ²
	20 3/4"	1890	1290	1890	8000	10	142	6.3	118.2	13.2

NEW



V5674, EAN 4047728**056748**

Air ratchet

- For areas with restricted access
- Reversing switch on ratchet head

QUICKGIANT

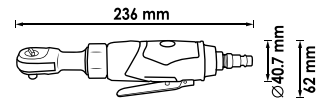

6.3 1/4"



12.91 (w) 7.2

Coupler plug included



kg
0.6



mm	Nm	1/min.	Ø mm	l/min	bar	dB(A)
6.3 1/4"	35	240	10	77	6.3	Lp A 87.5

V6554, EAN 4047728**065542**

Air ratchet

- For areas with restricted access
- Reversing switch on ratchet head

QUICKGIANT

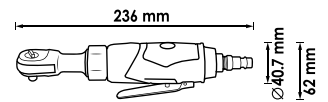

10 3/8"



12.91 (w) 7.2

Coupler plug included



kg
0.6



mm	Nm	1/min.	Ø mm	l/min	bar	dB(A)
10 3/8"	35	240	10	77	6.3	Lp A 87.5

NEW

V5675, EAN 4047728**056755**

Air ratchet

- For areas with restricted access
- Reversing switch on ratchet head

QUICKGIANT

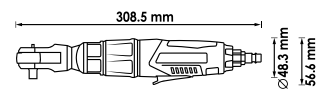

12.5 1/2"



12.91 (w) 7.2

Coupler plug included



kg
1.2

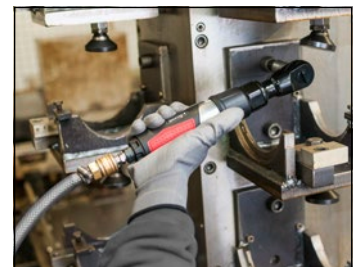

mm	Nm	1/min.	Ø mm	l/min	bar	dB(A)
12.5 1/2"	67	160	10	114	6.3	Lp A 89.5

Die grinder

EQUIPMENT
VIGOR

V5672, EAN 4047728056724

Die grinder, straight design

- Cutter, cutting wheels, grinding pads with a 3 and 6 mm collet chuck



SPEED GIANT

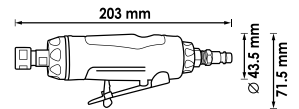

12.91 (4) 7.2

Coupler plug included

3 + 6 mm



kg
0.54



		W				
mm	1/min.	watt	Ø mm	l/min	bar	dB(A)
3-6	22000	350	10	128.2	6.3	Lp A 86.1

V5673, EAN 4047728056731

Die grinder, angled

- Cutter, cutting wheels, grinding pads with a 3 and 6 mm collet chuck



SPEED GIANT



Including
Ø 3 mm collet
chuck

Including
Ø 6 mm collet
chuck

12.91 (4) 7.2

Coupler plug included

3 + 6 mm



kg
0.45

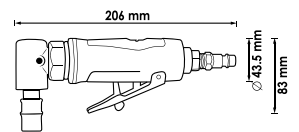

		W				
mm	1/min.	watt	Ø mm	l/min	bar	dB(A)
3-6	20000	250	10	85.5	6.3	Lp A 99.1

V6906, EAN 4047728069069

Die grinder set, mini

- Straight design
- Small design for areas with restricted access
- For grinding, polishing or deburring
- Including 3 and 6 mm collet chuck
- Exhaust air is guided downwards through the handle
- Including 10-piece grindstone set V6906-10

SPEED GIANT



15



NEW

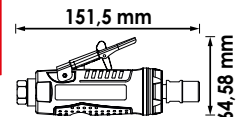

		W					
mm	1/min.	watt	kg	Ø mm	l/min	bar	dB(A)
3-6	2500	185	0.31	10	85.5	6.3	102

V6906-10, EAN 4047728069571

Grindstone set

- Grinding stones for VIGOR die grinders V6906, V5672 and V5673

10



V6903, EAN 4047728069038

Angle grinder

- Angled version for working in tight spaces
- Robust, practical design
- Universally suitable for processing a wide variety of materials
- Adjustable protection plate reduces flying sparks and catches material residues
- Exhaust air is guided downwards through the handle
- For cut-off wheels V6811-76 (76 x 1.6 x 10 mm)

RAZEGiANT

NEW

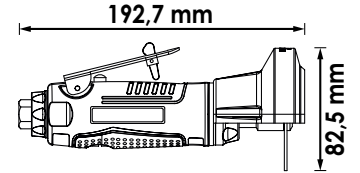

12,91 (ø) 7,2

Coupler plug included

kg
0.7



		W			
mm	1/min.	watt	l/min	bar	dB(A)
10	18000	245	128	6.3	90.4

V6904, EAN 4047728069045

Drilling machine

- Quick-action drill chuck
- Exhaust air is guided downwards through the handle
- One-hand operation with ergonomic handle
- Lighter and more compact than conventional or cord-type drilling machines

DRILLGiANT

NEW

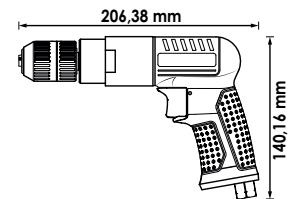

Ø 1-10 mm



Coupler plug included

12,91 (ø) 7,2

		W			
mm	1/min.	watt	l/min	bar	dB(A)
1-10	1800	245	114	6.3	103

Pneumatic guns



V6905, EAN 4047728**069052**

Tyre inflator

- One-hand operation with ergonomic handle
- Rubber-coated manometer for protecting against small impacts
- Easily legible precision manometer with bar and PSI display
- Graduation: 0.1 bar
- Easily adjustable filling lever and discharge button, easy to reach on the handle
- Discharge button for levelling the filling capacity



FILLGIANT 



NEW

0 - 8,5 bar / 0 - 120 psi

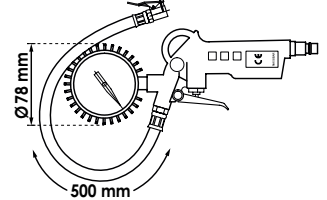

12.91 (1/4) 7.2

Coupler plug included



V2655, EAN 4047728**026550**

Air blow gun

- Fast removal and cleaning of chips and other foreign objects



270 mm

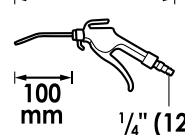

12.91 (1/4) 7.2

Coupler plug included



V2666, EAN 4047728**026666**

Air blow gun, telescopic

- Fast removal and cleaning of chips and other foreign objects



510 mm

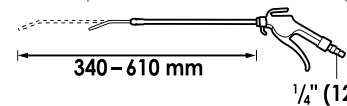

12.91 (1/4) 7.2

Coupler plug included





General workshop
tools



V4241, EAN 4047728**042413**

Control cabinet key Sub Maker Quadro 10 in 1

- For almost all standard locking systems in plumbing, heating, construction, ventilation, air conditioning etc.

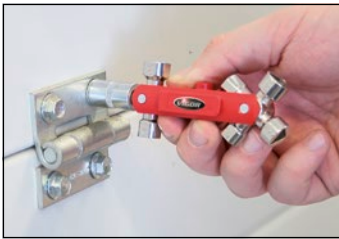
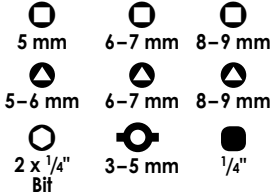

V4228, EAN 4047728**042284**

Site key MasterKey construction

- For almost all standard locking systems in plumbing, heating, construction, ventilation, air conditioning etc.
- Square mandrel allows the lock follower to be operated without a door handle or square pin

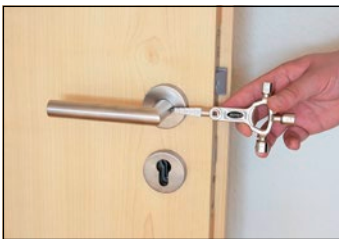

V4227, EAN 4047728**042277**

Site key MasterKey electronics

- For almost all standard locking systems in plumbing, electronics, heating, ventilation, air conditioning etc.

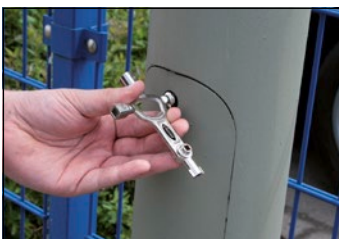
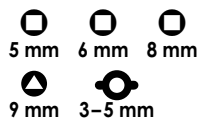

V4279, EAN 4047728**042796**

Set of Japan spatulas, metal

- Applying material or smoothing surfaces, as well as for use in several other application fields
- Width of spatula 50 · 80 · 100 · 120 mm



Made from highly flexible spring steel strip



V4278, EAN 4047728**042789**

Set of Japan spatulas, plastic

- Applying material or smoothing surfaces, as well as for use in several other application fields
- For work on the car body, e.g. filling holes and dents as well as several other application fields
- Width of spatula 50 · 80 · 100 · 120 mm



V5480, EAN 4047728**054799**

Telescopic inspection mirror set

- Visual inspection in areas with restricted access
- Double joint with tension spring for a view of hard to reach areas
- Replaceable mirror thanks to quick change system with 6.3 mm socket

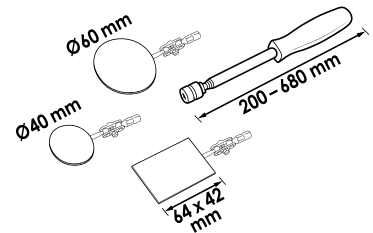

Mirror changeable using quick-change system



Quick identification of e.g. oil loss, corrosion or cable connections



V1740, EAN 4047728068673

Magnetic pick-up tool, semi-flexible

- Retractable magnet enables selective attachment
- High-quality plastic handle
- Semi-flexible shank

NEW

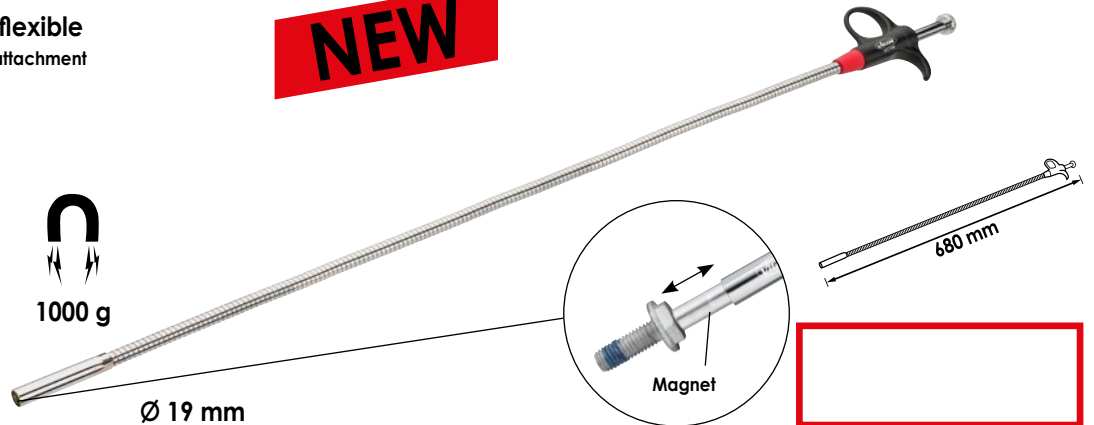

V1741, EAN 4047728017411

Telescope magnetic pick-up tool

- Picking up parts containing iron even in inaccessible parts
- Telescoping
- Practical bag clip

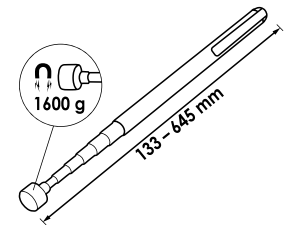

V1764, EAN 4047728017640

Magnetic pick-up tool with claws, flexible

- Picking up small parts such as screws, nuts, etc. at inaccessible places. With magnet for additional support
- Gripping and magnetic function

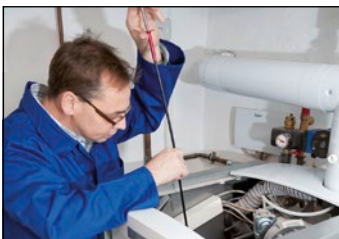

V1438, EAN 4047728014380

Tweezers set

- Ideal for working e.g. in hard-to-reach areas
- Easy grip
- Stainless steel



3

STAINLESS STEEL



V1893, EAN 4047728018937

Precision oiler

- Fine dosing tip
- Special pump button for drip-free application
- With screw cap
- Aluminium housing
- Clip
- Application range:
Motor vehicles, bicycles, locks, model making, sewing machines, hinges, power tools, lubricating/spraying and lots more



V5512, EAN 4047728055123

Gas soldering iron set

- Soldering, melting, shrinking and hot cutting work with seven different adapters
- Flexible, stand-alone use due to gas operation
- Device combines three functions into one:
- Soldering iron, maximum temperature: 450 °C
- Burner, maximum temperature: 1300 °C
- Hot air blower, maximum temperature: 600 °C
- Small and easy to handle for working directly on the vehicle, for example
- Continuous gas regulation for optimum adaptation to the work to be carried out and the material
- Flame temperature maximum: 1300 °C
- Stand for stationary working conditions
- Piezo ignition
- Filling with commercial lighter / ISO butane gas
- Contents:
 - Gas soldering iron
 - Soldering tip 3.5 mm
 - Soldering tip 4.5 mm
 - Heat-shrink tubing extension
 - Cutting tip
 - Soldering sponge protection cap
 - Solder wire



Improved solder tips



Fill level indicator



Gas valve



Stainless steel



V5488, EAN 4047728054881

Multifunctional drain pan, 50 l

- Used as a cleaning pan, dirt pan, oil pan, disinfection pan, leakage pan, transport pan and feed pan e.g. in sanitary and heating construction, the motor vehicle industry and workshops, for hunting equipment, chemical/laboratory use, food industry/butcheries, fishing, pet supplies, horse accessories, etc.
- Alkaline-resistant and acid-resistant

Universal application with huge capacity

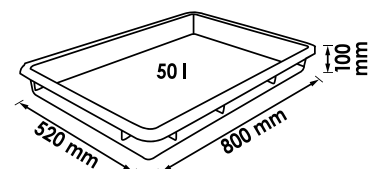

V5677, EAN 4047728056779

Magnetic cup with plastic frame

- Two strong magnets for fixing to car lifts, tool trolleys, machinery, etc.
- Setting aside small magnetic and non-magnetic parts – free hands for work
- Plastic frame offers a work surface for plastic screws etc. and also serves as a catch tray
- Small parts are stored so they are clearly visible and easy to find again

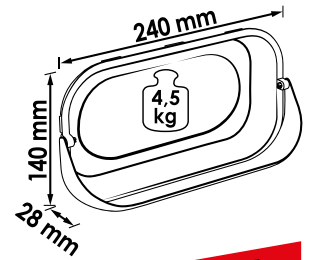

NEW

A little helper for great organisation!



V6468, EAN 4047728064682

Nozzle adjusting tool with magnet

- Nozzle adjustment of windscreen washing systems
- Additional function as magnetic pick-up tool
- Bag clip



Narrow insert pin \varnothing 0.6 mm

approx. 550 g
 \varnothing 6 mm

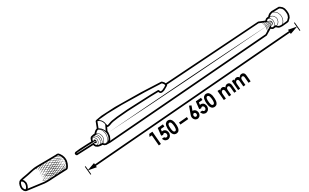

Incl. display for a purchase of at least 16 pieces



V6742, EAN 4047728067423

Magnetic tool holer

- Storage of impact sockets, impact wrenches, torque wrenches or hoses directly on site
- Strong magnets (each with \varnothing 80 mm) guarantee a good hold on car lifts, tool trolleys or other magnetic substrates
- Magnetic holding force: approx. 20 kg



Optimal storage of impact sockets and impact wrenches directly on site!



NEW

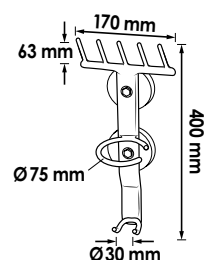

V6605, EAN 4047728066051

Fender cover

- Protection from dents, scratches, oil and dirt
- One size fits all
- Does not cover wheels



NEW



V6606, EAN 4047728066068

Reusable seat cover

- Protection of car seat against heavy soiling
- One size fits all, for most passenger cars and common commercial vehicles
- Light nylon, PU-coated
- Water, grease and oil repellent
- Contents: 1 piece
- Washable at 40 °C

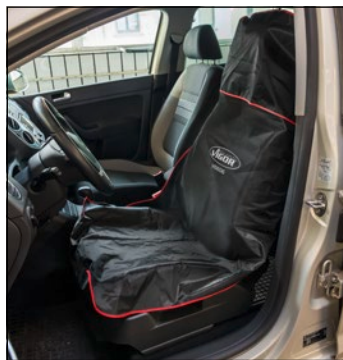

NEW

Dimensions:
L: 1350 x W: 760 mm



V6435, EAN 4047728064354

Work gloves

- Assembly work in the workshop, warehouse / logistics and anywhere where secure grip and precision are important
- Light polyester woven gloves with ergonomic fit
- Size 9
- EN 388:2003 (3131A)



NEW

Black latex coating on the palms!



V2338, EAN 4047728023382

Kneeling mat

- High-quality foam
- Knee-protecting
- Heat insulating
- With carrying handle

Comfortable and low-impact working in the workshop, in industry, in the garden or in the household!

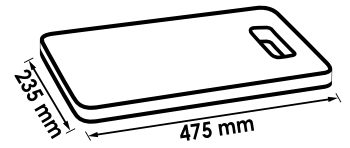

V6973, EAN 4047728069731

Mechanic's creeper

- Padded head rest
- Two side storage compartments for screws or other small parts
- High-quality finish made of plastic
- Easy to clean
- Six castors made of hard plastic
- Loading capacity maximum 150 kg

NEW



Work comfortably under vehicles!

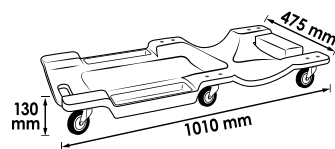
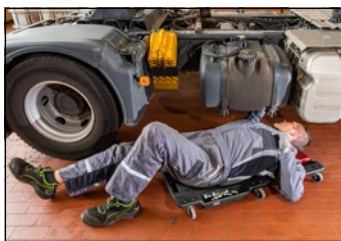

V6973-1, EAN 4047728069748

Replacement castor for mechanic's creeper

- Robust plastic castor made of polypropylene with screw-on plate
- Break-proof, traceless and odourless
- Low rolling resistance
- Clevis 2 mm wall thickness
- Maximum loading capacity 30 kg
- Including screws
- Contents: 1 piece



V5925, EAN 4047728059251

LED inspection light

- Locating leaks e.g. in air conditioning systems or heat pumps
- Use with commercially available leak detection additives
- LED with two levels: 160 lumen / 60 lumen
- Operating time: 3:45 h at 100% / 7:45 h at 50%
- Strong magnet
- Charging time: approx. 3 h
- UV cap lamp
- Including micro USB cable



Mini USB interface



UV light



Including sales display for a purchase of at least 6 pieces

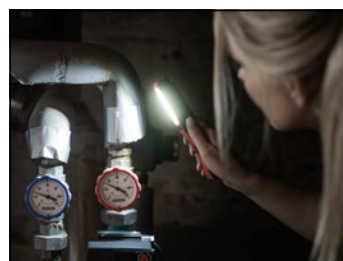
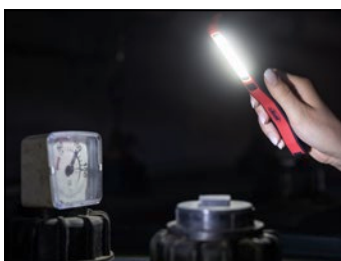

V2316, EAN 4047728023160

LED folding light

- Rechargeable Li-Ion battery 3.6 V
- 3.5-4 h
- 5 LED = 300 Lux at a distance of 60 cm
- 18 LED = 800 Lux at a distance of 60 cm
- approx. 200 g
- Height: 220 mm
- IP30

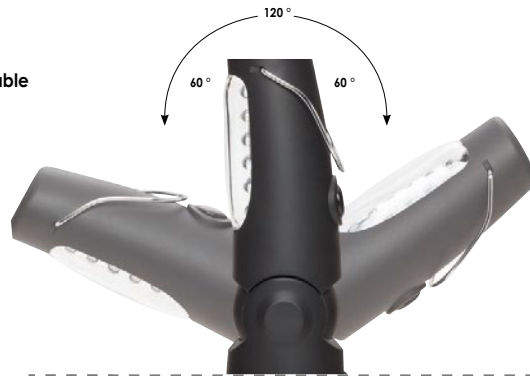

V2347, EAN 4047728023474

12 V charger for LED folding light V2316

- For cigarette lighter



V5540, EAN 4047728055406

LED head lamp

- Selectable modes to set pointed lighting or floodlighting
- 3 W LED point focusing maximum 185 lm
- 1.5 W COB LED with wide-angle illumination maximum 130 lm



IP 54
Including 3 x AAA micro 1.5 V batteries



V4969, EAN 4047728049696

LED light

- 3 watt LED
- Luminous flux: 90 Lumen
- Shock-proof aluminium housing
- Adjustable head for focusing
- Belt clip
- With 1 x AA battery
- Length 110 mm



Including sales display for a purchase of at least 10 pieces



5 h



V6299, EAN 4047728062039

Non-contact infrared thermometer

- Laser for contact-free measuring in various application areas, such as in motor vehicles, industry, private households, gas, heating and air conditioning units, etc.
- Measuring range: -35 °C to +630 °C
- Universal application range
- Robust plastic housing
- Red-luminescent laser
- Automatic switch-off function
- With 9V block battery
- CE-tested



Illuminated LCD digital display

NEW

Temperature readings in seconds at the touch of a button!



V4646, EAN 4047728046466

Brush set

- Professional cleaning and deburring of cylinders, tubes, bushings etc.
- For drilling machines and pneumatic drills
- Note: When operating with power tools only use the brushes running forward
- 12 nylon brushes:
 - Ø 8 · 9 · 10 · 11 · 12 · 13 · 14 · 15 · 16 · 17 · 18 · 19 mm
- 12 steel brushes:
 - Ø 8 · 9 · 10 · 11 · 12 · 13 · 14 · 15 · 16 · 17 · 18 · 19 mm
- 12 brushes with brass coating:
 - Ø 8 · 9 · 10 · 11 · 12 · 13 · 14 · 15 · 16 · 17 · 18 · 19 mm
- 1 handle with chuck and quick lock
- 1 extension 150 mm



38

Spare parts 10 pieces per pack

VIGOR No.	Designation	EAN 4047728+
V4646M-8	Brass brush set Ø 8 mm	054102
V4646M-9	Brass brush set Ø 9 mm	054119
V4646M-10	Brass brush set Ø 10 mm	054126
V4646M-11	Brass brush set Ø 11 mm	054133
V4646M-12	Brass brush set Ø 12 mm	054140
V4646M-13	Brass brush set Ø 13 mm	054157
V4646M-14	Brass brush set Ø 14 mm	054164
V4646M-15	Brass brush set Ø 15 mm	054171
V4646M-16	Brass brush set Ø 16 mm	054188
V4646M-17	Brass brush set Ø 17 mm	054195
V4646M-18	Brass brush set Ø 18 mm	054201
V4646M-19	Brass brush set Ø 19 mm	054218



VIGOR No.	Designation	EAN 4047728+
V4646N-8	Nylon brush set Ø 8 mm	054225
V4646N-9	Nylon brush set Ø 9 mm	054232
V4646N-10	Nylon brush set Ø 10 mm	054249
V4646N-11	Nylon brush set Ø 11 mm	054256
V4646N-12	Nylon brush set Ø 12 mm	054263
V4646N-13	Nylon brush set Ø 13 mm	054270
V4646N-14	Nylon brush set Ø 14 mm	054287
V4646N-15	Nylon brush set Ø 15 mm	054294
V4646N-16	Nylon brush set Ø 16 mm	054300
V4646N-17	Nylon brush set Ø 17 mm	054317
V4646N-18	Nylon brush set Ø 18 mm	054324
V4646N-19	Nylon brush set Ø 19 mm	054331

VIGOR No.	Designation	EAN 4047728+
V4646S-8	Steel brush set Ø 8 mm	053587
V4646S-9	Steel brush set Ø 9 mm	053594
V4646S-10	Steel brush set Ø 10 mm	053600
V4646S-11	Steel brush set Ø 11 mm	054010
V4646S-12	Steel brush set Ø 12 mm	054027
V4646S-13	Steel brush set Ø 13 mm	054034
V4646S-14	Steel brush set Ø 14 mm	054041
V4646S-15	Steel brush set Ø 15 mm	054058
V4646S-16	Steel brush set Ø 16 mm	054065
V4646S-17	Steel brush set Ø 17 mm	054072
V4646S-18	Steel brush set Ø 18 mm	054089
V4646S-19	Steel brush set Ø 19 mm	054096

Flap disc set 115 mm

- High stock removal rate; allows effortless surface grinding on steel and stainless steel without smearing. Does not leave scratches on the workpiece
- Universal flap disc with long service life
- Dimensions: 115x22.23 mm
- Maximum 13280 rpm
- Contents: 10 pieces
- Grain size: 40

V6810-115K40,
EAN 4047728**067737**



NEW



Flap disc set 115 mm

- High stock removal rate; allows effortless surface grinding on steel and stainless steel without smearing. Does not leave scratches on the workpiece
- Universal flap disc with long service life
- Dimensions: 115x22.23 mm
- Maximum 13280 rpm
- Contents: 10 pieces
- Grain size: 60

V6810-115K60,
EAN 4047728**067744**



Flap disc set 115 mm

- High stock removal rate; allows effortless surface grinding on steel and stainless steel without smearing. Does not leave scratches on the workpiece
- Universal flap disc with long service life
- Dimensions: 115x22.23 mm
- Maximum 13280 rpm
- Contents: 10 pieces
- Grain size: 80

V6810-115K80,
EAN 4047728**067751**



Flap disc set 125 mm

- High stock removal rate; allows effortless surface grinding on steel and stainless steel without smearing. Does not leave scratches on the workpiece
- Universal flap disc with long service life
- Dimensions: 125x22.23 mm
- Maximum 12200 rpm
- Contents: 10 pieces
- Grain size: 40

V6810-125K40,
EAN 4047728**067782**



NEW



Flap disc set 125 mm

- High stock removal rate; allows effortless surface grinding on steel and stainless steel without smearing. Does not leave scratches on the workpiece
- Universal flap disc with long service life
- Dimensions: 125x22.23 mm
- Maximum 12200 rpm
- Contents: 10 pieces
- Grain size: 60

V6810-125K60,
EAN 4047728**067775**



Flap disc set 125 mm

- High stock removal rate; allows effortless surface grinding on steel and stainless steel without smearing. Does not leave scratches on the workpiece
- Universal flap disc with long service life
- Dimensions: 125x22.23 mm
- Maximum 12200 rpm
- Contents: 10 pieces
- Grain size: 80

V7010-125K80,
EAN 4047728**070690**



Cut-off wheel set

- Handheld cut-off wheels for stainless steel and steel for thin sheet metal (e.g. car body), steel cables, profiles, tubes, non-ferrous metals and high-temperature-resistant materials
- Particularly sharp disc with good service life
- Dimensions: 76 x 1.6 x 10 mm
- Maximum 20100 rpm
- Contents: 25 pieces

V6811-76,
EAN 4047728**070287**



NEW



Cut-off wheel set

- Handheld cut-off wheels for stainless steel and steel for thin sheet metal (e.g. car body), steel cables, profiles, tubes, non-ferrous metals and high-temperature-resistant materials
- Particularly sharp disc with good service life
- Dimensions: 115x1.0x22.23 mm
- Maximum 13280 rpm
- Contents: 10 pieces

V6811-115,
EAN 4047728**067287**



Cut-off wheel set

- Handheld cut-off wheels for stainless steel and steel for thin sheet metal (e.g. car body), steel cables, profiles, tubes, non-ferrous metals and high-temperature-resistant materials
- Particularly sharp disc with good service life
- Dimensions: 125x1.0x22.23 mm
- Maximum 12200 rpm
- Contents: 10 pieces

V6811-125,
EAN 4047728**067768**



Electrical system	263
Multimeter and measuring cable sets	263–264
Cable release tools	265
Crimping pliers set	266



Electrical system

Multimeter and measuring cable sets

EQUIPMENT
VIGOR

V4324, EAN 4047728**043243**

Digital multimeter

- Compact and practical
- High-contrast, one-line LCD display including backlighting
- 19-position rotary switch
- Reliable warning thanks to automatic overflow and polarity display for preventing possible errors
- Stand-up positioning including protective rubber cover
- Measuring cable with protection against contact
- DC: 200 mV – 600 V
- AC: 200 V – 600 V
- DC: 200 mA – 10 A
- Resistance: 200–2000 Ohm
- Diode tester
- Maximum display: 1999
- 9 V battery (in device)
- Fuses:
 - 1 x 250 mA / 250 V
 - 1 x 10 A / 250 V
- Multimeter for testing quiescent current
- Used with measuring cable set V4326
- Functions:
 - Direct and alternating current measurements
 - Direct and alternating current measurement
 - Resistance measurement
 - Diode test (with acoustic signal)
 - Passage inspection (with acoustic signal)
 - Data hold function



VIGOR No.	Designation	X	EAN 4047728+
V4324-1	Fuses 5 pieces	5	053532
V4324-2	Measuring cable for V4324	2	053549

V1722, EAN 4047728**017220**

Car light tester

✓ 6–24 V

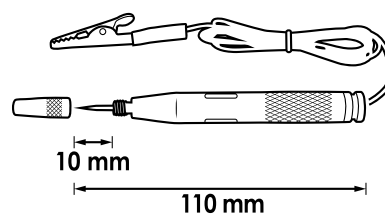
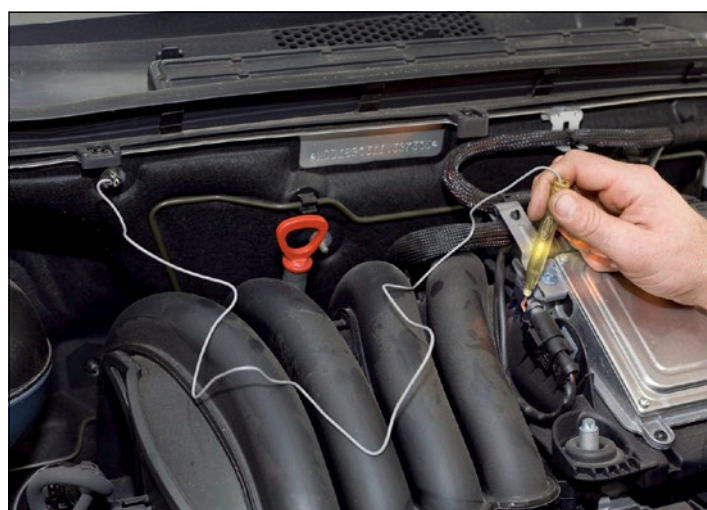

V4326, EAN 4047728**043267**

Measuring cable set

- Motor vehicle applications and 12 V batteries
- Measuring line adapters for simplifying fault diagnostics directly on the vehicle
- Polarity testers for testing hall sensor and photo sensors
- Measuring potentiometer for testing the temperature sensor and tank sensor
- Use with multimeter V4324
- 3 flat terminals, flat terminal sleeves, round terminals, pin-type cable connectors and pin-type cable sleeves



Flat terminal sizes:
0.8 · 1.2 · 2.0 · 2.5 · 3.0 · 5.0 · 6.0 mm



Round terminal sizes:
4.0 · 3.5 · 2.0 · 1.5 · 0.8 mm



2x crocodile clips, jaw opening up to 30 mm



2x connection cables, each 1 m in length



4x test needles, i.e. for testing very small plug connections



2 x two-tone LED test cables for determining the polarity
- Positive polarity = LED green
- Negative polarity = LED red



2x test tips for use with the cable to be tested and crocodile clips



2x 5K Ohm potentiometer steplessly adjustable



2x jumper plugs, 1 (Female bushing) on 2 (Male) connections



2x SRS test resistors for SRS airbag and belt tightening systems

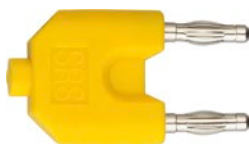

V4326/2, EAN 4047728**069809**

Test needle set



V4451, EAN 4047728044516

Cable release tool set

- Damage-free release of electrical plugs and connectors e.g. with ABS, air conditioning sensors, radio, PDC, trailer coupling modules and much more
- Fast trouble-shooting with corrosion or connection defects
- For round and flat connectors



23

<p>Use BMW, MERCEDES-BENZ, OPEL/VAUXHALL, VW/AUDI</p>	<p>Use BMW, JAGUAR, MERCEDES-BENZ, PORSCHE, SAAB, SEAT, ŠKODA</p>	<p>Use BMW, MERCEDES-BENZ, OPEL/VAUXHALL, PORSCHE, VW/AUDI</p>	<p>Use FORD</p>	<p>Use BMW, FORD, MERCEDES-BENZ, OPEL/VAUXHALL, PORSCHE, SEAT, ŠKODA, VW/AUDI</p>	<p>Use BMW, FORD, JAGUAR, OPEL/VAUXHALL, MERCEDES-BENZ, PORSCHE, SAAB, SEAT, ŠKODA, VW/AUDI</p>	<p>Use MERCEDES-BENZ</p>	<p>Use FORD, JAGUAR, MERCEDES-BENZ, OPEL/VAUXHALL, PORSCHE, VW/AUDI</p>	<p>Use FORD, MERCEDES-BENZ</p>
<p>Use MERCEDES-BENZ</p>	<p>Use BMW, FORD, JAGUAR, MERCEDES-BENZ, OPEL/VAUXHALL, PORSCHE, SAAB, SEAT, ŠKODA, VW/AUDI</p>	<p>Use OPEL/VAUXHALL, RENAULT, ŠKODA, VW/AUDI</p>	<p>Use FORD, MERCEDES-BENZ</p>	<p>Use FORD, JAGUAR, PORSCHE</p>	<p>Use BMW, FORD, MERCEDES-BENZ, OPEL/VAUXHALL, SEAT, ŠKODA, VW/AUDI</p>	<p>Use BMW, FORD, JAGUAR, MERCEDES-BENZ, OPEL/VAUXHALL, PORSCHE, VW/AUDI</p>	<p>Use BMW</p>	<p>Use MERCEDES-BENZ</p>
<p>Use CITROËN, FIAT CHRYSLER, FORD, HONDA, MAZDA, OPEL/VAUXHALL, MERCEDES-BENZ, MITSUBISHI, PORSCHE, RENAULT, SEAT, TOYOTA, VW/AUDI</p>	<p>Use FORD</p>	<p>Use BMW, FORD, JAGUAR, MERCEDES-BENZ, OPEL/VAUXHALL, PORSCHE, SAAB, SEAT, ŠKODA, VW/AUDI</p>	<p>Use HONDA, OPEL/VAUXHALL, TOYOTA, VW/AUDI</p>	<p>Use OPEL/VAUXHALL, VW/AUDI</p>	<p>Indispensable for mechatronics technicians and motor vehicle electricians</p>			

VIGOR No.	Designation	EAN 4047728+
V4451-1	Individual cable release tool 1 BMW, MERCEDES-BENZ, OPEL/VAUXHALL, VW/AUDI	053693
V4451-2	Individual cable release tool 2 BMW, JAGUAR, MERCEDES-BENZ, PORSCHE, SAAB, SEAT, ŠKODA	053709
V4451-3	Individual cable release tool 3 BMW, MERCEDES-BENZ, OPEL/VAUXHALL, PORSCHE, VW/AUDI	053716
V4451-4	Individual cable release tool 4 FORD	053723
V4451-5	Individual cable release tool 5 BMW, FORD, MERCEDES-BENZ, OPEL/VAUXHALL, PORSCHE, SEAT, ŠKODA, VW/AUDI	053730
V4451-6	Individual cable release tool 6 BMW, FORD, JAGUAR, OPEL/VAUXHALL, MERCEDES-BENZ, PORSCHE, SAAB, SEAT, ŠKODA, VW/AUDI	053747
V4451-7	Individual cable release tool 7 MERCEDES-BENZ	053754
V4451-8	Individual cable release tool 8 FORD, JAGUAR, MERCEDES-BENZ, OPEL/VAUXHALL, PORSCHE, VW/AUDI	053761
V4451-9	Individual cable release tool 9 FORD, MERCEDES-BENZ	053815
V4451-10	Individual cable release tool 10 MERCEDES-BENZ	053822
V4451-11	Individual cable release tool 11 BMW, FORD, JAGUAR, MERCEDES-BENZ, OPEL/VAUXHALL, PORSCHE, SAAB, SEAT, ŠKODA, VW/AUDI	053839

VIGOR No.	Designation	EAN 4047728+
V4451-12	Individual cable release tool 12 OPEL/VAUXHALL, RENAULT, ŠKODA, VW/AUDI	053846
V4451-13	Individual cable release tool 13 FORD, MERCEDES-BENZ	053853
V4451-14	Individual cable release tool 14 FORD, JAGUAR, PORSCHE	053860
V4451-15	Individual cable release tool 15 BMW, FORD, MERCEDES-BENZ, OPEL/VAUXHALL, SEAT, ŠKODA, VW/AUDI	053877
V4451-16	Individual cable release tool 16 BMW, FORD, JAGUAR, MERCEDES-BENZ, OPEL/VAUXHALL, PORSCHE, VW/AUDI	053884
V4451-17	Individual cable release tool 17 BMW	053891
V4451-18	Individual cable release tool 18 MERCEDES-BENZ	053907
V4451-19	Individual cable release tool 19 CITROËN, FIAT CHRYSLER, FORD, HONDA, MAZDA, OPEL/VAUXHALL, MERCEDES-BENZ, MITSUBISHI, PORSCHE, RENAULT, SEAT, TOYOTA, VW/AUDI	053914
V4451-20	Individual cable release tool 20 FORD	053921
V4451-21	Individual cable release tool 21 BMW, FORD, JAGUAR, MERCEDES-BENZ, OPEL/VAUXHALL, PORSCHE, SAAB, SEAT, ŠKODA, VW/AUDI	053938
V4451-22	Individual cable release tool 22 HONDA, OPEL/VAUXHALL, TOYOTA, VW/AUDI	053945
V4451-23	Individual cable release tool 23 OPEL/VAUXHALL, VW/AUDI	053952



V2499, EAN 4047728024990

Crimping pliers set

- Five replaceable crimping sockets:
- Crimping socket A: for insulated cable lugs from 0.5–6.0 mm² (red, blue, yellow)
- Crimping socket B: for closed, non-insulated cable lugs of 1.5 · 2.5 · 6.0 · 10 mm²
- Crimping socket C: for open, non-insulated cable lugs from 0.5–6.0 mm² (width up to 6.3 mm)
- Crimping socket Ø for wire end sleeves with or without collar from 0.5–4.0 mm²
- Crimping socket F: for wire end sleeves above 6.0 mm²



With locking lever

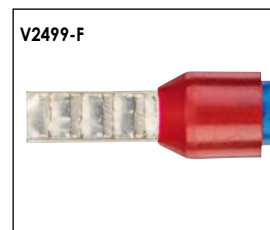
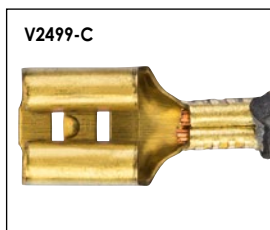
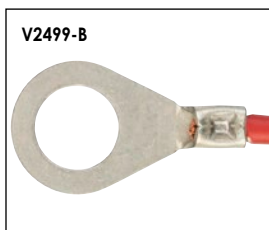
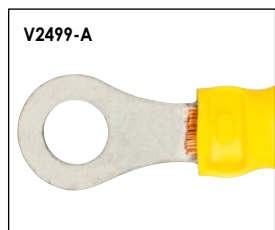

Spare parts

VIGOR No.	Designation	EAN 4047728+
V2499-A	Crimping socket A: for insulated cable lugs from 0.5 – 6.0 mm ² (red, blue, yellow)	053440
V2499-B	Crimping socket B: for closed, non-insulated cable lugs of 1.5 · 2.5 · 6.0 · 10 mm ²	053457
V2499-C	Crimping socket C: for open, non-insulated cable lugs of 0.5 – 6.0 mm ² (width up to 6.3 mm)	053464
V2499-D	Crimping socket D: for wire end sleeves with or without collar from 0.5 – 4.0 mm ²	053471
V2499-F	Crimping socket F: for wire end sleeves above 6.0 mm ²	053488



Engine / Radiator / A/C

Engine tools	268–271
Injector sealing seat cleaning	272
Engine timing tools	273–283
Cooling system diagnostics	284–287
Turbo system diagnostics	288–289
Compression and pressure loss testers	290–291



V5676, EAN 4047728**056762**

Lambda probe set

- Lambda probes, injection nozzles as well as thermal circuit-breakers in hard to reach areas



● 22 mm

10 3/8

80

← L →
mm



● 22 mm

10 3/8

90

← L →
mm



● 27 mm

10 3/8

74

← L →
mm



● 22 mm

12 1/2



● 29 mm

12 1/2

90

← L →
mm



○ 27 mm

12 1/2

83

← L →
mm



● 22 mm

10 3/8



V6741, EAN 4047728067416

Puller set for ignition coils

- Professional and damage-free removal of ignition coils and ignition coil strips on VAG and OPEL/VAUXHALL engines
- Attaching and then removing enables an even disassembly of the ignition module
- Recommended use in pairs
- Greatest market coverage
- Set consisting of:
 - Puller type A, 26 mm
 - Puller type B, 18 mm
 - Puller type C, 43 mm
 - Puller type D, 35 mm
 - 2x ignition module puller
- Pullers for, among others:
 - For CHEVROLET/GMC Aveo Cruze
 - OPEL/VAUXHALL Adam · Agila-B · Astra- J · Cascada Combo · Corsa D · Meriva B · Mokka · Zafira Tourer
- Engines:
 - 1 litre A10XEP (LDB), 1.2: A12XEL (LWD) A12XER (LDC), 1.4: A14XEL (L2Z) A14XER (LDD) LDU
 - 1.4 litres (T) A14NEL (LUH) A14NET (LUJ) Twinport / ecoFLEX engines
- OPEL/VAUXHALL 3 or 4-cylinder petrol injection engines e.g. in Agila A · Astra F · Astra G · Astra H · Astra J · Calibra Combo · Corsa-B · Corsa-C · Corsa-D · Frontera A · Frontera B · Insignia · Meriva A · Meriva B · Omega B · Signum · Tigra A · Tigra B · Vectra B · Vectra C · Zafira A · Zafira B
- Engine codes:
 - 20LEH · 2HO · A10XEP · A14NEL · A14NET · A14XER · A16LET · A16XER · A18XER · C22SEL · LDD · LDE · LLU · LUH · LUJ · X14NZ · X14SZ · X14XE · X16SZR · X16XE · X16XEL · X18XE · X20SE · X20XEV · X22SE · X22XE · Y22SE · Z10XEP · Z12XE · Z12XEP · Z14XE · Z14XEL · Z14XEP · Z16LEL · Z16LER · Z16LET · Z16XE · Z16XER · Z16YNG · Z18XE · Z18XER · Z20LER
- Ignition claws:
 - TYPE A (26 mm):
e.g. VW Golf · Bora · Beetle · Lupo · Passat · Touran · T4 · AUDI A2
 - TYPE B (18 mm):
Bora · Golf · Passat · Sharan · Touareg · Phaeton · T5
 - TYPE C (43 mm):
8 and 12-cylinder engines such as Phaeton, among others
 - TYPE D (35 mm):
Direct injection engine VW Golf · Touran · Passat and Eos, as well as AUDI A4 and A6



6

NEW

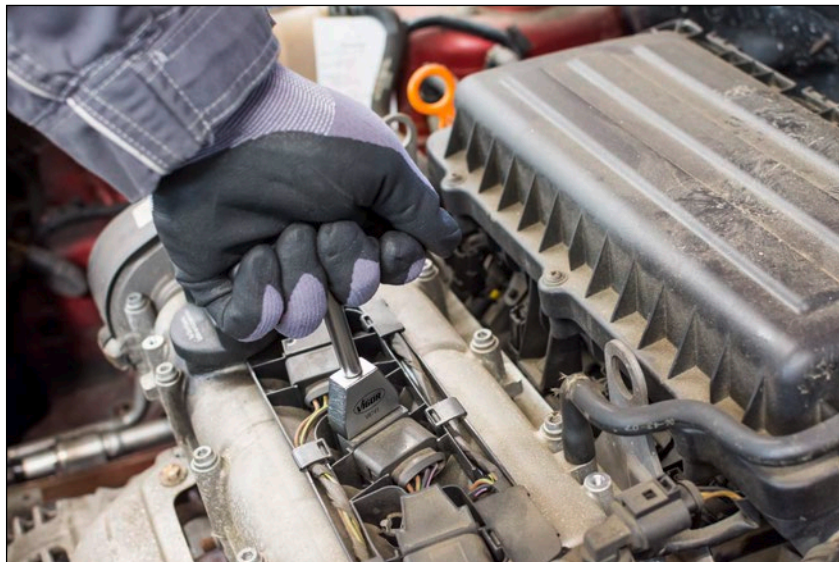

V5047, EAN 4047728**050470**

Lock nut set for diesel engines

- Various pressure tests on the engine
- Contents:
 - 6 lock nuts each M 12x1.50 and M 14x1.50 with inside sealing cone
- Sealing the injector for subsequent pressure loss test on the engine
- Plastic case included



Protects the injector from contamination and adhesion after being removed from the fuel line

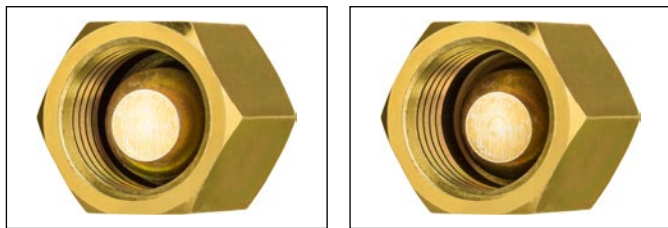

V3381, EAN 4047728033817

Hose clamp set

- For hoses with Ø up to 45 mm



V3571, EAN 4047728035712

V-ribbed belt tool

- Fibre-glass reinforced nylon
- Most easy-to-use tool on the market
- No adjustment necessary
- For all flexible belts: air-conditioning systems, generators, and single/double pulleys



Assembly



Disassembly



V4941, EAN 4047728**049412**

Injector sealing seat cleaning set

- Eliminating soot residues, particles on HDI, diesel direct injection and common rail engines with Bosch and Delphi injectors
- Including sealing plug for protection against combustion chamber contamination
- Centring crowns for accurate guiding

Proper cleaning of the injector sealing seat, injector tip and pintle opening

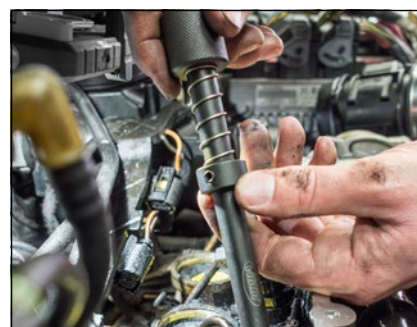

	VIGOR No.	Designation	mm	X	EAN 4047728+
①	V3604	Basic unit	267	1	036047
②	V3573	Adapter	294	1	035736
③	V3572	Sealing ring remover	230	1	035729
④	V3574	Brush	300	1	035743
⑤	V3575	Brush	85	1	035750
⑥	V3576	Threaded rod	200	1	035767
⑦	V3577	Drive	107	1	035774

	VIGOR No.	Designation	mm	X	EAN 4047728+
⑧	V3578	Threaded coil M5 x 0.8 mm	15.2	6	035781
⑨	V3579	Adapter Ø 20.6 mm	32	1	035798
⑩	V3580	Adapter Ø 22 mm	32	1	035804
⑪	V3591	Adapter Ø 24.5 mm	32	1	035910
⑫	V3592	Cutter Ø 15 / 17 mm	39	1	035927
⑬	V3593	Cutter Ø 19 / 17 mm	39	1	035934
⑭	V3594	Cutter Ø 17 mm	39	1	035941



V4285, EAN 4047728**042857**

Engine timing tool set RENAULT

- Diesel and petrol engines with different displacements
- Locking the flywheel
- Locking the crankshaft, camshaft and injection pump shaft
- Removing the crankshaft pulley
- Tensioning the timing belt
- Positioning the camshaft and pump shaft for the crankshaft
- For RENAULT engine variants:
 - Petrol: 1.2 · 1.4 · 1.7 · 3.6 · 1.8 · 2.0 16 V · 2.2 8 · 2.5 20 V
 - Diesel: 1.9 D/TD · 2.1 · 2.2 D/TD · 2.5/TD · 2.8 D
- Also for petrol and diesel engines of the vehicle models Volvo V40 · S40 and OPEL/VAUXHALL Arena · Movano
- Examples of engine codes: B16 · B18 · B20 · N7Q · N7U · K4J · K4M · F4P · F4R · D7F · E5F · E7F · E7J · K7M · F1N · F3N · F3P · F2R · F3R · F7P · F7R · J5R · J7R · J5T · F8M · F8Q · G8T · J8s · F9Q · S8U · S9U · S9W



17

Cannot be used as a counterholder when tightening the camshaft and crankshaft locking devices

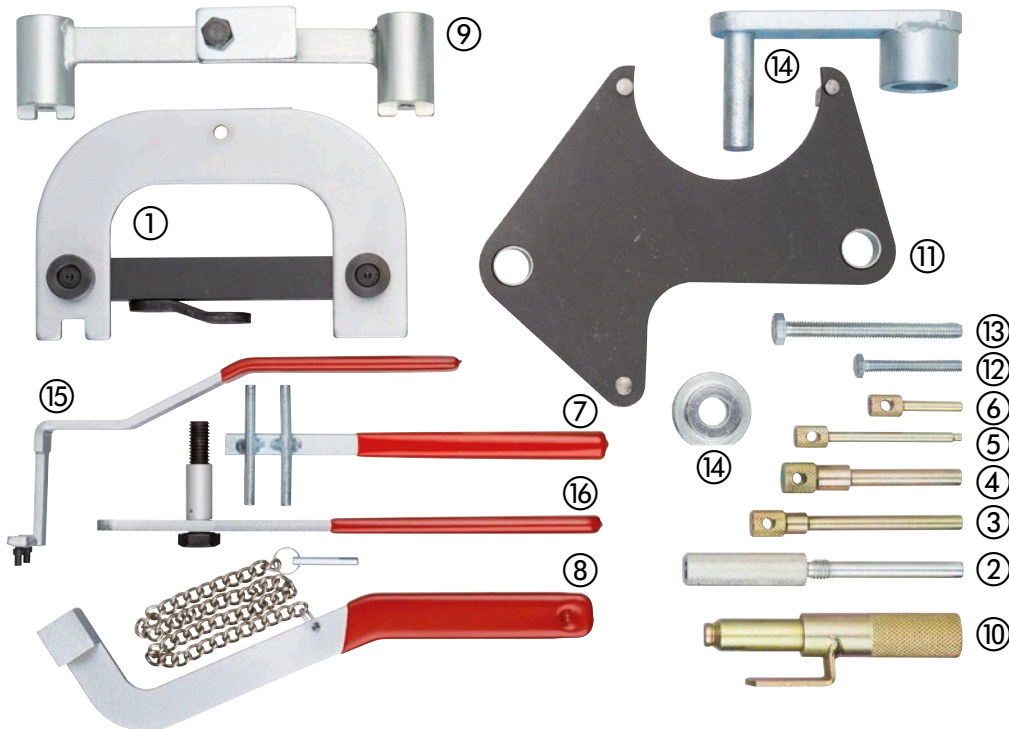

	Designation	OEM No.
①	Camshaft tool	MOT1496
②	Crankshaft locking pin	MOT1489
③	Flywheel locking pin	MOT1318
④	Flywheel locking pin	MOT861 · MOT1054
⑤	Injection pump locking pin	MOT910
⑥	Crankshaft locking pin	MOT910
⑦	Belt tensioner square drive	MOT1135-01
⑧	Tensioning tool	MOT1348

	Designation	OEM No.
⑨	Camshaft tool	MOT1337
⑩	Crankshaft locking pin	MOT1340
⑪	Camshaft tooth alignment tool	MOT1490-01
⑫	Fixing screw M 6 x 30 mm	-
⑬	Fixing screw M 8 x 70 mm	-
⑭	Tensioning tool	MOT1386
⑮	Tensioning tool	MOT1384
⑯	Tensioning tool	MOT1312



V4283, EAN 4047728**042833**

Engine timing tool set BMW

- 4-cylinder petrol engines with 1.6 · 1.8 and 2.0 l displacement and twin camshafts
- Locking of the camshaft and crankshaft
- Adjusting the camshaft
- Installation / removal of the camshaft as well as the variable camshaft timing unit (Double Vanos)
- For BMW:
 - 1 Series: E81 · E87
 - 3 Series: E46 · E90 · E91
 - 5 Series: E60 · E61
 - X3: E83
 - Z4: E85
- Examples of engine codes: N42 · N46 and N46T

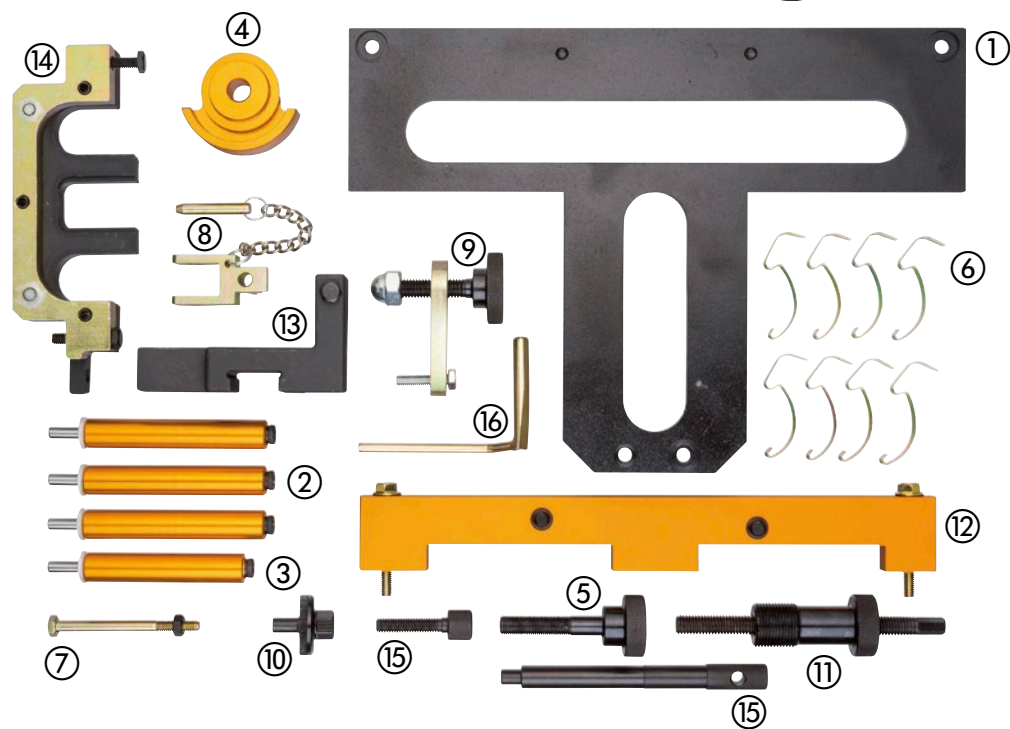

	Designation	OEM No.
①	Carrier bracket socket	11 9 320
②	3 long stud bolts	11 9 320
③	1 short stud bolt	12 9 320
④	Eccentric shaft setting tool	11 9 302
⑤	Knurled screw	11 9 302
⑥	Intermediate lever clamps, 8 pieces	11 9 310
⑦	Bolt and nut	11 9 390
⑧	Torsion spring tool holder	11 9 390

	Designation	OEM No.
⑨	Eccentric shaft tool holder	11 9 301
⑩	Camshaft turning tool	11 9 270
⑪	Tensioning tool	11 9 340
⑫	Sensor wheel fixing rail	11 9 350
⑬	Camshaft positioning angle	11 9 292
⑭	Camshaft setting plate	11 9 291
⑮	2 fixing screws	11 9 293
⑯	Locking pin, bent	11 9 190



V4284, EAN 4047728**042840**

Engine timing tool set BMW

- 1.6 l petrol engines
- Installation / removal of the camshafts
- Changing the timing chain
- Replacing the cylinder head gasket
- Setting the Vanos adjuster unit
- Pre-tensioning the chain tensioner
- For BMW:
 - 1 Series: E87
 - 3 Series: E46 · E90
- Examples of engine codes: N40 · N45 and N45T

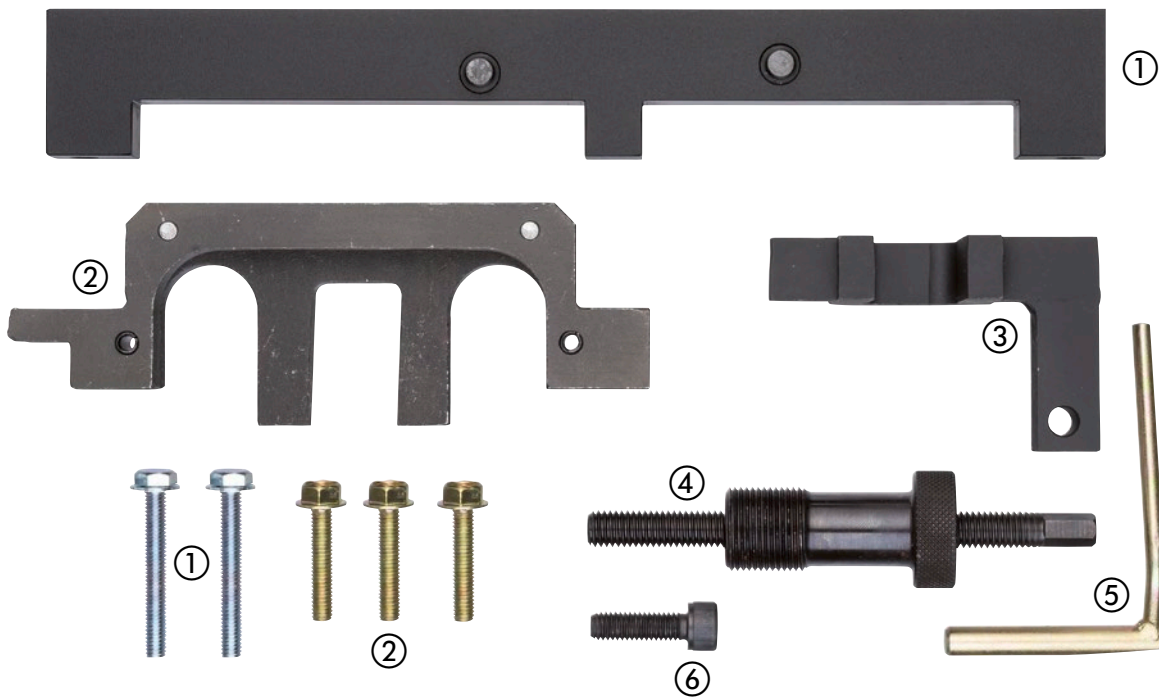
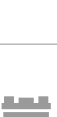

	Designation	OEM No.
①	Camshaft sensor wheel fixation, including 2 screws M 6 x 55 mm	11 7 260
②	Outlet camshaft fixation, including 2 screws M 6 x 30 mm	11 7 251
③	Inlet camshaft fixation including 1 screw M 6 x 30 mm	11 7 252

	Designation	OEM No.
④	Tensioning tool	11 9 340
⑤	Locking pin crankshaft	11 9 190
⑥	Knurled screw M 8 x 25 mm	11 7 253

V4282, EAN 4047728**042826**

Engine timing tool set VAG

- Diesel and petrol engines with different displacements
- Replacing the timing belt and the water pump (setting the bonnet lock and clearances is dispensed with)
- Locking the timing belt pulley of the crankshaft for TDI pump injector engines (VAG: 1.2 l · 1.4 l · 1.9 l)
- Locking the oval timing belt pulley of the crankshaft for TDI pump injector engines or for engine repairs (VAG: 1.9 l and 2.0 l)
- Locking the timing belt tensioning device for TDI pump injector engines (VW · AUDI · SEAT and ŠKODA)
- Locking the injection pump sprocket for TDI engines without a pump injector and for positioning the camshaft for pump injector engines (VAG)
- Locking the camshaft with conventional TDI technology (VAG)
- Timing belt replacement without removing the intake pipe and valve cover
- Locking both camshafts for petrol engines (1.4 l and 1.6 l: VW: Lupo · Polo · Golf · Bora AUDI: A2)
- Locking the crankshaft and camshaft for work on the engine control (V6 2.5 TDI · V8 2.5 TDI and 3.3 TDI for VW and AUDI)
- Adjustment ruler for camshafts in diesel engines (D · SD and TD)
- Examples of engine codes:
 ABM · ADA · ADP · AEH · AEK · AFT · AHL · AKL · AKS · ALZ · ANA · APF · ARM · AUR · AVU · AYD · BFQ · BFS · BGU · BSE · BSF · ABS · ADR · ADZ · AGN · AJP · APG · APT · APX · ARG · AEB · AGU · AJH · AJL · AJQ · AMK · ANB · APP · APU · APY · AQA · AQX · ARX · ARY · ARZ · AUM · AVC · AWC · AWT · AWU · AUQ · AYP · BAM · ADL · 2E · AAC · AAE · ABF · ABK · ABT · ACE · ADY · AEG · AGG · AKT · APK · AQY · ATM · ATU · AWF · AWG · AXA · AZH · AZJ · AZL · AZM · BEH · AHB · AHG · AKU · AKW · 1X · 1Y · AAZ · ABL · AEY · AGD · AGP · AQM · ASX · ASY · AYQ · AAZ · AFF · AFN · AGR · AHF · AHH · AHU · ALE · ALH · ASV · AVG · ANY · ANY · AYZ · AMF · ATL · BAY · BHC · BNM · BNV · AJM · AMG · ANU · ARL · ARX · ASZ · ATD · ATJ · AUU · AVB · AVF · AVQ · AWX · AXB · AXC · AXR · BEW · BJB · BKC · BKE · BLS · BLT · BPX · BRB · BRM · BRU · BSV · BSW · BTB · BVK · ANU · ASZ · AUU · AZV · BKD · BDJ · BDK · BGW · BHW · BKP · BLB · BMA · BMM · BMN · BMP · BMR · BNA · BPW · BRC · BRE · BRF · BRT · BSS · BUY · BUZ · BVE · BVF · BVG · BWV



33

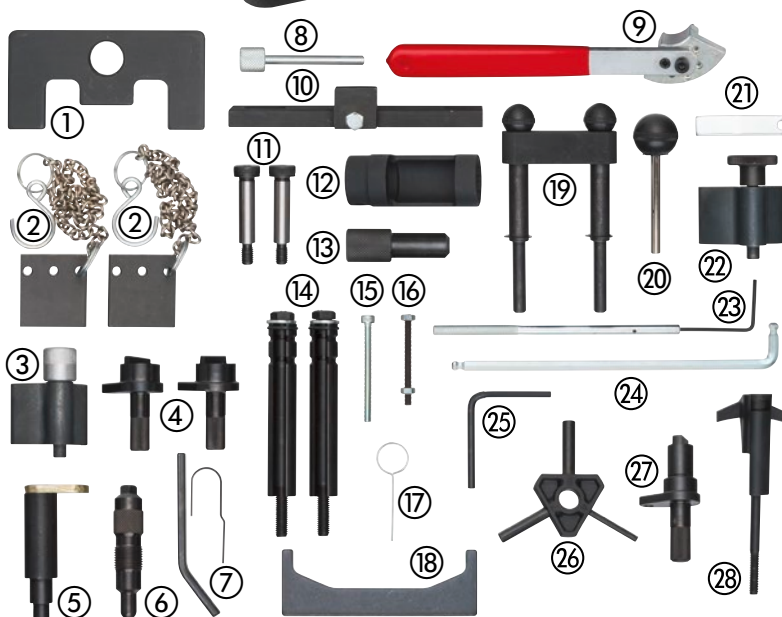

Cannot be used as a counterholder when tightening the camshaft and crankshaft locking devices

	Designation	OEM No.
①	Camshaft adjustment gauge	3418
②	Camshaft locking tool, 2 pieces	3458
③	Crankshaft timing belt pulley retainer, oval	T10100
④	Camshaft holding tool, 2 pieces	T10123
⑤	Crankshaft locking bolt	T10121
⑥	Crankshaft locking pin	3242
⑦	Locking pin	-
⑧	Injection pump sprocket locking pin	3359 · U-40074 · T20102
⑨	Tensioner pulley wrench, VAG similar	T10020
⑩	Camshaft adjustment gauge	T10098A
⑪	Camshaft setting screw for gauge, 2 pieces	T10098A
⑫	Special socket wrench 1/2", size 22 mm, double hexagon	3078
⑬	Injection pump sprocket locking pin	2064
⑭	Front mask service position, 2-pieces	3369

	Designation	OEM No.
⑮	Fan coupling locking screw	-
⑯	Belt tensioner relief bolts	T10092
⑰	Clamping device locking pin	T40011
⑱	Camshaft adjustment gauge	2065A · U-40021
⑲	Camshaft locking device VAG T10016 / T10074 (without bridge)	T10016 · T10014 · T10074
⑳	Injection pump sprocket locking pin	3359 · T20102
㉑	Tensioning device retainer	T10008 · 23-058 · 310-084
㉒	Crankshaft timing belt pulley retainer	T10050 · 310-085 · 23-059
㉓	Tensioner roller holding tool	T10265
㉔	Special offset screwdriver size 6 mm	T10264
㉕	Tensioning unit locking pin	T10060A
㉖	Locking pin combination 4 · 7 and 8 mm	-
㉗	Camshaft holding tool	T10120
㉘	Chain tensioner holder	3366

V4346, EAN 4047728**043465**

Engine timing tool set VAG 3 cylinder petrol

- VAG 1.2 l, 3 cylinder 6 V and 12 V petrol engines: Locking the camshaft and crankshaft, injection pump shaft, crankshaft pulley and tensioning the chain
- SEAT: Ibiza · Córdoba (model years 2002 → 2008)
- ŠKODA: Fabia · Roomster (model years 2002 → 2007)
- VW: Fox (model years 2005 → 2008) · Polo (model years 2002 → 2007) · Eos (model years 2006 → 2008)
- Examples of engine codes: AWY · AZQ · BBM · BME · BXV · BZG

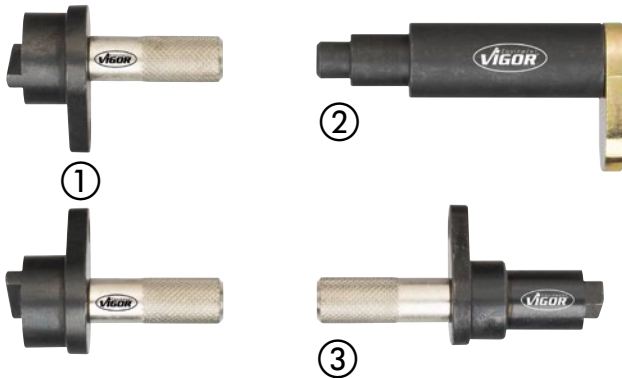

	Designation	OEM No.
①	Camshaft adjusting tool set, 2 pieces	T10123
②	Camshaft adjusting tool	T10121
③	Locking pin for crankshaft	T10120

V4372, EAN 4047728**043724**

Engine timing tool set VAG 1.2 l · 1.4 l · 1.6 l FSI · TSI · TFSI

- VAG 1.4 l · 1.6 l FSI · TSI · TFSI with thread M 12x1.25 mm
- AUDI: A1 (model years 2012 → 2012)
- SEAT: Altea · Altea XL (model years 2008 → 2012) · Ibiza · Córdoba (model years 2008 → 2012) · León (model years 2007 → 2012) · Toledo (model years 2007 → 2009)
- ŠKODA: Fabia 2 (model years 2007 → 2012) · Octavia 2 (model years 2004 → 2012) · Roomster (model years 2006 → 2012) · Superb 2 (model years 2009 → 2012) · Yeti (model years 2009 → 2012)
- VW: Caddy (model years 2010 → 2012) · Eos (model years 2006 → 2012) · Golf (model years 2003 → 2012) · Golf Plus (model years 2003 → 2012) · Jetta (model years 2006 → 2012) · Passat (model years 2005 → 2011) · Polo (model years 2002 → 2012) · Scirocco (model years 2008 → 2012) · Tiguan (model years 2007 → 2012) · Touran (model years 2003 → 2012)
- Examples of engine codes: AXU · BAG · BKG · BLF · BLN · BLP · BMY · BTS · BLG · BWK · CAVA · CAVB · CAVC · CAVD · CAVF · CAXA · CAXC · CDGA



	Designation	OEM No.
①	Clamping device locking pin	T40011
②	Camshaft locking tool	T10171
③	Camshaft holding tool	T10414
④	Crankshaft locking pins	T10340
⑤	Dial gauge retainer receptacle 8.0 mm	T10170

V4373, EAN 4047728**043731**

Engine timing tool set VAG 1.6 I, 2.0 I TDI common rail

- VAG 1.6 I · 2.0 I TDI common rail diesel engines
- Locking of the camshaft, balance shaft and crankshaft
- Installation / removal of camshaft sprockets
- Timing belt replacement and engine repair
- VW: Golf 5 / 6 Plus · Polo · Jetta 5 / 6 · Caddy 2 · Beetle 2 · Passat B6 · B7 · CC · Scirocco 3 · Eos · Touran 3 · Sharan 2 · T5
- AUDI: A1 · A3 (8P) · A5 · A6 (C6 / C7) · TT (8J) · Q3 · Q5
- ŠKODA: Fabia 2 · Roomster · Praktik · Octavia 2 · Superb 2 · Yeti
- SEAT Ibiza (6J) · León 3 · Exeo · Altea · Alhambra 2
- Examples of engine codes:
CAYA · CAYB · CAYC · CAGA · CAGB · CAGC · CAHA · CAHB · CBAA · CBAB · CABD · CBBA · CBBB · CBDA · CBDB · CBDC · CBEA · CEGA



	Designation	OEM No.
①	Special offset screwdriver size 6 mm	T10264
②	Tensioner roller holding tool	T10265
③	Belt tensioner locking pin	T40098
④	Camshaft sprocket counterholder	T10051
⑤	Oil pump balancer shaft	T10255
⑥	Injection pump sprocket locking pin	T20102 - 3359
⑦	Camshaft sprocket extractor	T10052 - (6610-09)
⑧	Crankshaft timing belt pulley retainer	T10100
⑨	Crankshaft timing belt pulley retainer	T10050

V4424, EAN 4047728**044240**

Adjustment of camshafts VAG 1.8 I, 2.0 I

- Adjustment of camshafts on VAG 1.8 I / 2.0 I TFSi engines
- Installation / removal of the camshaft valve on camshaft timing
- Changing timing chain or engine repair
- AUDI: A3 (model years 2003 → 2004) · A4 (model years 2007 → 2013) · A5 (model years 2007 → 2013) · Q5 (model years 2007 → 2013) · TT (2008 → 2013)
- VW: Passat (model year 2006) · Passat CC (model year 2009)
- Examples of engine codes:
CABA · CABB · CAWB · CDAA · CDAB · CBFA · CCTA · CCZA · CDAH · CDN8 · CDNC



	Designation	OEM No.
①	Camshaft valve tool	T10352/1
②	Camshaft valve tool	T10352
③	Camshaft valve tool	T10352/2

V4374, EAN 4047728**043748**

Engine timing tool set VAG 2.0 I FSI / TFSI Turbo

- Petrol engines 2.0 I FSI and TFSI Turbo
- Timing belt replacement and engine repair
- AUDI: A3 · A4 · A6 · S3 · TT
- VW: Golf · Golf Plus · Jetta · EOS · Touran (model years 2003 → 2010) · Passat
- ŠKODA: Octavia 2
- Examples of engine codes:
AWA · AXW · AXZ · BGB · BHD · BHZ · BLR · BLX · BLY · BMB · BPG · BPE · BPJ · BPY · BUL · BVX · BVY · BVZ · BWA · BWE · BWJ · BWT · BYD · BYK · BZC · CDLA · CDLB · CDLC · CDLD · CDMA



7

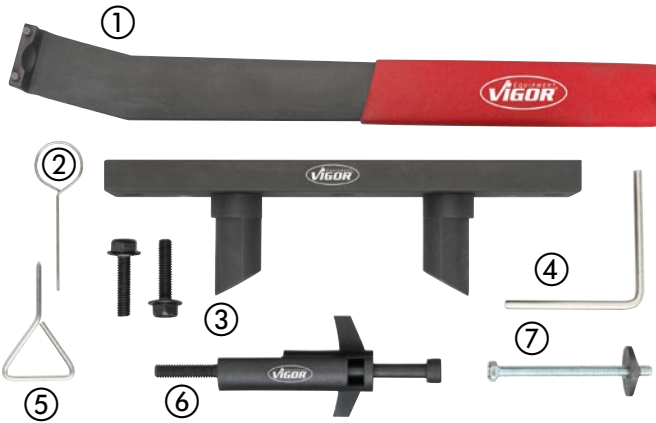

	Designation	OEM No.
①	Tensioner pulley wrench, offset	T10020
②	Clamping device locking pin	T40011
③	Camshaft locking tool	T10252
④	Tensioning unit locking pin	T10060A
⑤	Locking pin	T10115
⑥	Chain tensioner holder	3366
⑦	Belt tensioner tightening screw	T10092

V4371, EAN 4047728**043717**

Engine timing tool set VAG 2.4 I · 3.2 I FSI

- VAG / AUDI 2.4 I · 3.2 I FSI V6 · V8 and V10 petrol engines
- Locking of the camshaft and crankshaft
- Fixation of the chain tensioning unit
- Changing the timing chain
- Adjusting the timing during engine repairs
- AUDI A4 · A6 series B7 and C6
- Examples of engine codes:
AUK · BDW · BGP · BGQ · BKH · BPK · BYU · BVJ · BNS · BYH · CAUA · BXA · BSM



5



	Designation	OEM No.
①	Camshaft holding, 2 pieces	T40070
②	Rotating adapter for crankshaft	T40058
③	Crankshaft locking pin	T40069
④	Chain tensioner retaining pin	T40071



V4375, EAN 4047728**043755**

Engine timing tool set VAG 2.7 I, 3.0 I V6 TDI

- VAG 2.7 I · 3.0 I TDi V6 common rail diesel engines
- Locking of balance shafts
- Locking of the camshaft and crankshaft
- Fixation of the chain tensioning unit
- Changing the timing chain
- Adjusting the timing during engine repairs
- VW: Touareg · Phaeton
- AUDI: A4 · A5 · A6 · A8 · Q5 · Q7
- Examples of engine codes:
ASB · BKN · BKS · BMK · BMZ · BNG · BPP · BSG · BUG · BUN ·
CAMA · CAMB · CANA · CANB · CANC · CAND · CAPA ·
CARA · CARB · CASA · CASB · CASC · CATA · CCMA · CCWA ·
CCWB · CDYA · CDYB · CDYC · CEXA · CGKA · CGKB



10

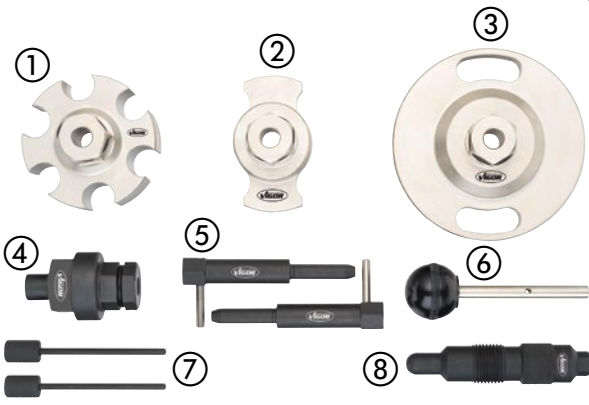

	Designation	OEM No.
①	Camshaft tool	T40061
②	Camshaft holding	T40062
③	Rotating adapter for crankshaft	T40049
④	Rotating adapter for crankshaft	T40058
⑤	Camshaft holding pins 2 x	T40060
⑥	Injection pump sprocket locking pin	3359
⑦	Chain tensioner retainer 2 x	-
⑧	Crankshaft locking pin	3242

V4423, EAN 4047728**044233**

Engine timing tool set AUDI 3.0 I V6 petrol engines

- AUDI 3.0 I V6 petrol engines
- Locking of camshafts and crankshaft
- Timing belt replacement and engine repair
- Positioning of timing belt tensioning unit
- AUDI: A4 / A4 Cabrio · A6 · A8
- For engine codes (e.g.):
ASN · AVK · BBJ



6



	Designation	OEM No.
①	Tensioner roller adjuster	3387
②	Camshaft holding, 2 x	T40030
③	Tensioner roller locking pin set	T40011
④	Cam phaser socket	T40028
⑤	Crankshaft holding pin	T40026

V4347, EAN 4047728043472

Engine timing tool set VAG

- VAG 1.2 l · 1.4 l and 1.9 l PD
- Locking the round timing belt pulley of the crankshaft
- Demarcation of the injection pump
- Blocking the tensioner roller
- VW · AUDI · ŠKODA · SEAT
- Examples of engine codes:
ANY · AYZ · AMF · ATL · BAY · BHC · BNM · BNV · AJM · AMG · ANU · ARL · ARX · ASZ · ATD · ATJ · AUZ · AVB · AVF · AVQ · AWW · AXB · AXC · AXR · BEW · BJB · BKC · BKE · BLS · BLT · BPX · BRB · BRM · BRU · BSV · BSW · BTB · BVK · ANU · ASZ · AUZ · AZV · BKD · BDJ · BDK · BGW · BHW · BKP · BLB · BMA · BMM · BMN · BMP · BMR · BNA · BPW · BRC · BRE · BRF · BRT · BSS · BUY · BUZ · BVE · BVF · BVG · BVH · BWV



	Designation	OEM No.
①	Crankshaft timing belt pulley retainer	T10050
②	Tensioning device retainer	T10008
③	Injection pump sprocket locking pin, 2 pieces	3359

V4348, EAN 4047728043489

Engine timing tool set VAG 1.9 l, 2.0 l PD

- VAG 1.9 l · 2.0 l PD
- Locking the oval timing belt pulley of the crankshaft
- Demarcation of the injection pump
- Blocking the tensioner roller
- VW · AUDI · ŠKODA · SEAT
- Examples of engine codes:
AZV · BKD · BDJ · BDK · BGW · BHW · BKP · BLB · BMA · BMM · BMN · BMP · BMR · BNA · BPW · BRC · BRE · BRF · BRT · BSS · BUY · BUZ · BVE · BVF · BVG · BVH · BWV



	Designation	OEM No.
①	Crankshaft timing belt pulley retainer, oval	T10100
②	Tensioning device retainer	T10008
③	Injection pump sprocket locking pin	3359

V4282-19, EAN 4047728043502

Camshaft locking tool VAG

- Locking of both camshafts on VAG 1.4 and 1.6 l engines
- AUDI: A3
- VW: Lupo · Polo · Golf / Plus · Caddy · Beetle · Bora
- ŠKODA: Fabia 1 and 2 · Octavia 1 and 2 · Roomster
- SEAT: Arosa · Ibiza · Córdoba · León · Toledo · Inca
- Examples of engine codes:
AFK · AHW · AJV · AKQ · APE · AQQ · ARC · ARR · ATN · AUA · AUB · AUS · AVY · AXP · AZD · BAD · BBY · BBZ · BCA · BCB · BKY · BUD · BXW



	Designation	OEM No.
①	Camshaft locking device (without bridge)	T10016 · T10074



V5484, EAN 4047728054843

Crankshaft counterholder

- Removing / installing timing belt pulleys on the camshaft, crankshaft and injection pump
- For e.g.:
VW Lupo, Polo, New Beetle, Golf, Caddy, Bora, Touran, Sharan, Transporter
AUDI A2 · A3 · A4 · A6 · TT
ŠKODA Fabia, Octavia, Superb
- Length: 680 mm
- Distance between pins: 100 mm and 46 mm
- Opening width: 33 mm



With replaceable pins

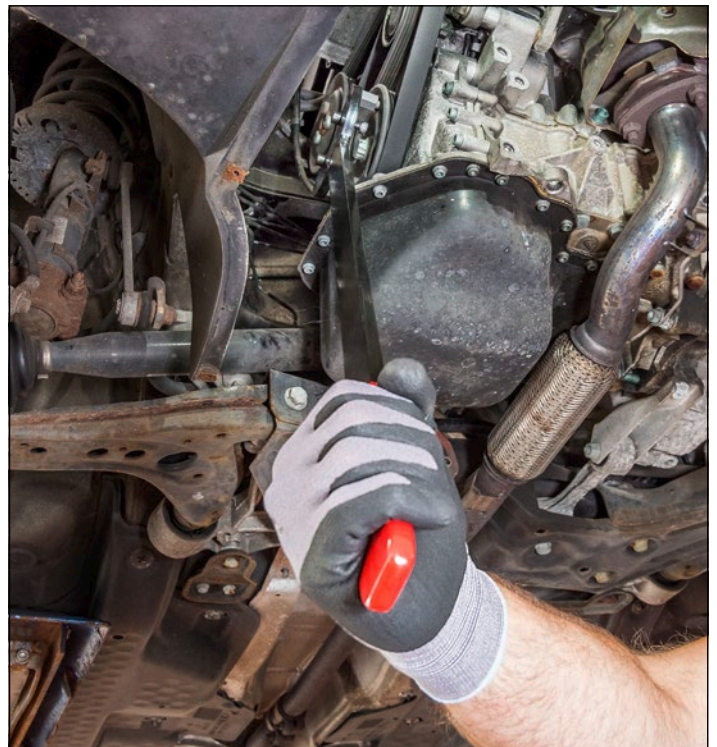



V1963N, EAN 4047728060097

Cooling system diagnosis set

- Passenger car diagnostics
- Complete set for service work on cooling and heating system
- Comprehensive range of adapters, for vehicles with water-cooled engines
- 3 features: pressure test (check for leaks in radiator system), refilling and cleaning
- Control of pressure loss via gauge
- Filling creates a vacuum in the radiator system (Advantage: coolant is sucked in without air bubbles)
- Enables refilling of even large engines without thermal influences
- Universal usage due to conical rubber radiator adapter
- Measuring range: 0 – 2.5 bar
- For hard-to-reach places, can optionally be combined with 90° adapter V1963-24
- Contents of V1963-23 · V1963-24
- Contents:
 - 1 hand pump with manometer · hose · pressure relief valve
 - 1 adapter, black, R123 · R124
 - 1 adapter, blue, R123 · R125
 - 1 cooling system adapter with bayonet fitting No. 3, large
 - 1 cooling system adapter with bayonet fitting No. 4, mid-size
 - 1 cooling system adapter with bayonet fitting No. 5, small
 - 13 cooling system screw adapters with inside thread
 - M 42x2.5 · M 42x3.0 · M 45x3.0 hollow ·
 - M 45x3.0 · M 46x3.0
 - M 48x2.5 · M 48x4.0 · M 50x2.5 · M 50x2.5 hollow
 - M 50x3.0 · M 52x3.0 · M 52.2x3.0 · M 60x4.0 mm
 - 4 cooling system screw adapters with outside thread
 - M 34x3.0 · M 45x3.0 · M 58x3.0 · M 62x3.0 mm
 - 1 vacuum filling unit with manometer
 - up to 76 cm / Hg = 1 bar
 - 1 rubber cone adapter, 45–14 mm, length: 75 mm
 - 1 thermometer, 0–220 °C · 0–400 °F
 - 1 90° adapter piece for areas with restricted access

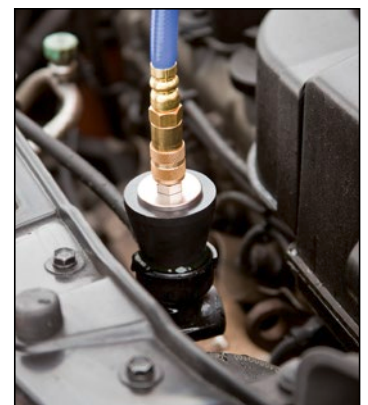

Greatest market coverage, 29 pieces



V1963-23, EAN 4047728060103

Adapter no. 23, M45x3.0

- Adapter no. 23 M 45x3.0 for the newer generation of VAG models
- Among others, suitable for:
 - AUDI A3 · A4 · A5 · A6 · A7 · A8 · Q2 · Q3 · Q5 · Q7
 - SEAT Alhambra · EXEO · Ibiza · Toledo
 - ŠKODA Citigo · Fabia · Octavia · Rapid · Roomster · Superb · Yeti
 - VW Amarok · Beetle · Caddy · EOS · Golf · Jetta · Bora · Passat · CC · Phaeton · Polo · Scirocco · Sharan · Tiguan · Touareg · Touran · UP! · e-UP!



V1963-24, EAN 4047728060110

Adapter 90°

- 90° adapter for cooling system diagnosis set V1963N
- Space savings of up to 50% in height
- 360° rotation



V1963-25, EAN 4047728060127

Universal adapter / tapered head

- Tapered universal adapter for the radiator test
- Minimal dimensions: 15 mm
- Maximum dimensions: 45 mm
- Rubber lining length: 75 mm



VIGOR No.	Designation	Adapter no.	EAN 4047728+	VIGOR No.	Designation	Adapter no.	EAN 4047728+
V1963-1	Hose	-	053228	V1963-15	M 50x2.5 hollow	15	053365
V1963-3	Test adapter black R123, R124	-	053242	V1963-16	M50x3.0	16	053372
V1963-4	Test adapter blue, R123, R125	-	053259	V1963-17	M52x3.0	17	053389
V1963-5	Bayonet adapter 3, large	3	053266	V1963-18	M60x4.0	18	053396
V1963-6	Bayonet adapter 4, medium	4	053273	V1963-19	M34x3.0	19	053402
V1963-7	Bayonet adapter 5, small	5	053280	V1963-20	M58x3.0	20	053419
V1963-8	M42x2.5	8	053297	V1963-21	M62x3.0	6	053426
V1963-9	M42x3.0	9	053303	V1963-22	Thermometer	-	053433
V1963-10	M 45x3.0 hollow	10	053310	V4257	Cooling system screw adapter, M 45x3.0 mm	22	042574
V1963-11	M46x3.0	11	053327	V4202	Vacuum filling unit	-	042024
V1963-12	M48x2.5	12	053334	V4258	Cooling system screw adapter, M 52.5x3.0 mm	21	042581
V1963-13	M48x4.0	13	053341	V3729	Hand pump with manometer	-	037297
V1963-14	M50x2.5	14	053358				



V5660, EAN 4047728**056601**

Coupling element from 4.4 mm to 7.2 mm

- Adaptation of hand pump V3729 with products from other manufacturers, e.g. Klann adapters / systems (4.4 mm to 7.2 mm)



V5922, EAN 4047728**059220**

Coupling element from 7.2 mm to 4.4 mm

- Adaptation of VIGOR cooling system adapter with e.g. Klann hand pumps / systems (7.2 mm to 4.4 mm)



V2459, EAN 4047728**024594**

Refractometer

- Fast, precise control of the anti-freeze concentration on coolant and screenwash as well as for checking the battery acid density and AdBlue
- Eyepiece with adjustable focus, equipped with rubber cup
- Left scale: battery acid density measuring range 1100 – 1300 sg / resolution 0.01 sg
- Middle scale: antifreeze based on propylene glycol G 13, measuring range -25 °C to -50 °C / resolution 5 °C, and antifreeze based on ethylene glycol G 11/G 12, measuring range -25 °C to -50 °C / resolution 5 °C
- Upper right scale: AdBlue (VRA) urea concentration, measuring range 30% – 35% / resolution 0.1%
- Lower right scale: screenwash antifreeze SRF 1, measuring range -10 °C to -40 °C / resolution 1 °C
- In plastic case with soft foam insert
- Contents:
 - 1 x refractometer
 - 1 x calibration screwdriver
 - 1 x pipette

Application e.g. for coolant, screenwash, battery fluid and AdBlue

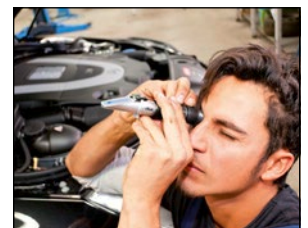

V1586, EAN 4047728**015868**

Anti-freeze tester

- For testing ethylene glycol coolant (anti-freeze) density in passenger cars, trucks, etc.



V4192, EAN 4047728041928

Turbo system pressure tester set for click systems

- Quick diagnosis of charging air systems in new generations of vehicles in which air pipes are connected with click systems
- Performing leak tests using noise generation, leak detector spray or pressure drop
- Contents:
6 plug pairs 31 · 38 · 46 · 51 · 56 · 61 mm

Enables time saving and appropriate determination of leaking charging air hoses



V4233, EAN 4047728042338

Manometer for turbo system pressure tester kit

- For V3595 · V4192 and V4331





V4304, EAN 4047728043045

Turbo system pressure tester kit for motor vehicles

- Fast diagnostics of the charging air system
- Proper, time-saving identification of leaky charge-air coolers and invisible cracks in charging air hoses
- Contents:
 - 1 pressure hose with manometer and equalization valve
 - 6 pairs of stepped adapters: 31/38 · 46/51 · 55/60 · 65/70 · 75/80 · 85/90 mm



Including manometer



V4305, EAN 4047728043052

Adapter 31/38 mm

- Use with manometer V4233 for testing the turbo system
- E.g. as an extension to the turbo system pressure tester kit V3595



V4306, EAN 4047728043069

Adapter 46/51 mm

- Use with manometer V4233 for testing the turbo system
- E.g. as an extension to the turbo system pressure tester kit V3595





V4461, EAN 4047728**044615**

Compression and pressure loss tester set

- Professional testing of compression and pressure loss for the engines of most of passenger cars, trucks, motorcycles, buses, agricultural vehicles and boats as well as Hdi, TDCi and pump injector engines
- For diesel and petrol engines
- Contains glow plug adapter for e.g.: ALFA ROMEO · BMW · CHRYSLER · DAEWOO · FIAT · FORD · HYUNDAI · ISUZU · LAND ROVER · MAZDA · MERCEDES-BENZ · MITSUBISHI · NISSAN · OPEL/VAUXHALL · PSA · RENAULT · SAAB · SUZUKI · TOYOTA · VAG · VAUXHALL · Volvo · etc.
- Glow plug adapter M 10, M 12, M 14, M 18
- Compression pressure gauge maximum 50 bar
- Quick coupler in straight and angled design
- Injector nozzle adapter M20, M22, M24 and for FORD Stanadyne injectors

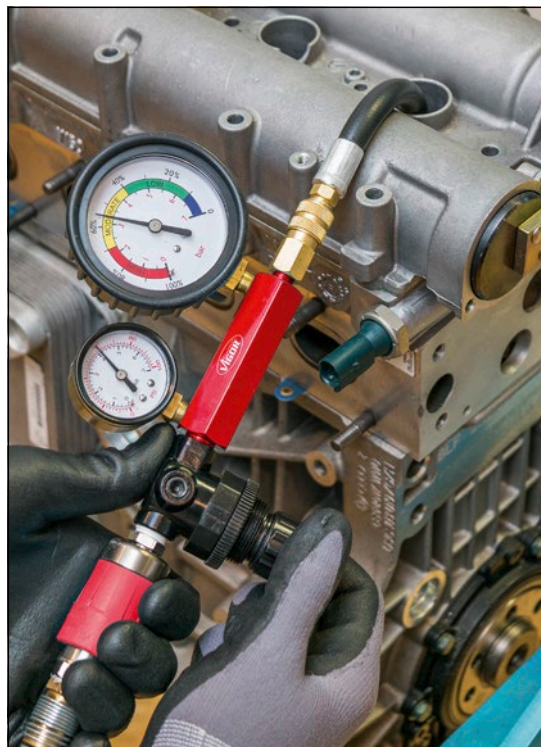

For diesel and petrol engines

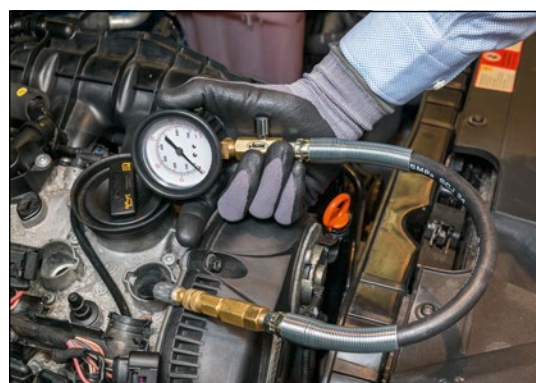
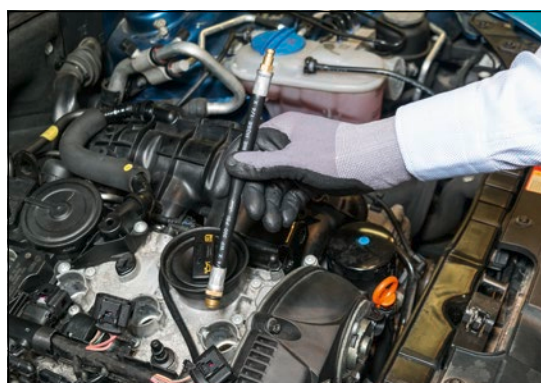

V4325, EAN 4047728043250

Vacuum and pressure pump set

- Testing pressure and underpressure systems
- Charging pressure
- Vacuum solenoids
- MAP sensors
- Tank aerations
- Brake line systems
- Including extensive assortment of adapters

28

*Also suitable
for brake line
systems*



Hose length: 630 m



Filling capacity:
120 ml



Robust metal
design

Display range: -1 to 4 bar
Underpressure indicator range: from -1 to 0 bar
Max. pressure: up to 3 bar
Max. underpressure: up to 0.7 bar







Oil dipsticks

294

Oil filter wrenches

295–296

Oil pumps and filling devices

297–299



V5048, EAN 4047728050487

Tank sensor key, universal

- Operation of locking on tank sensor
- For areas with restricted access

Proper and time-saving working without damaging the lock ring

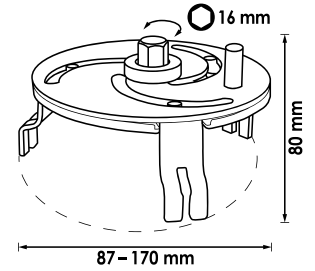

V2112, EAN 4047728021128

Oil dipstick set MERCEDES-BENZ

- Measuring the level of engine and automatic gearbox oil
- Essential after each oil change (vehicle provided by the manufacturer without dipstick, only with sealing plug)

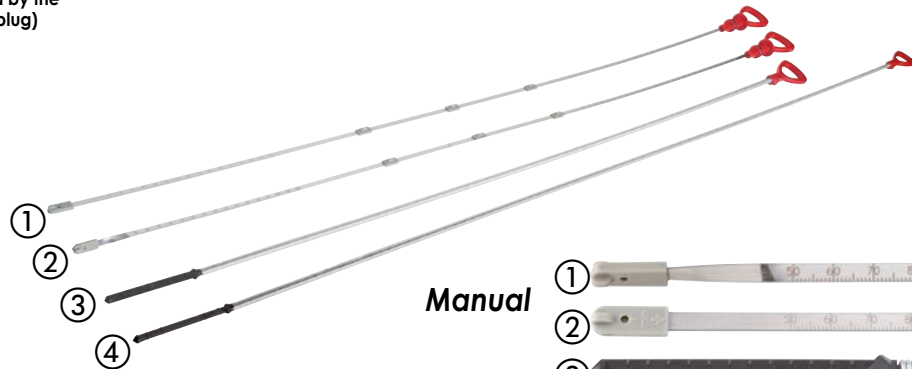

Manual



Automatic



V2645, EAN 4047728026451

Oil dipstick AUDI

- Check the level after oil change and subsequent comparison with the display
- For models with oil level indicator on the display (no dipstick in the engine)
- Helpful after replacing the oil sensor or calibrating the indicator in the driver's display (comparable to T40178)
- Application: for AUDI A4 / A5 / A6 with engines 1.8 · 2.0 TFSI / 3.0 · 3.2 FSI / 2.0 · 2.7 · 3.0 TDI, among others

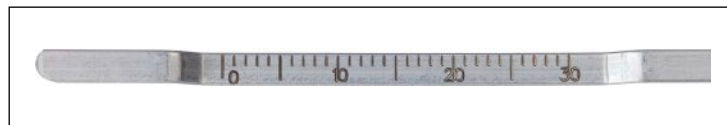
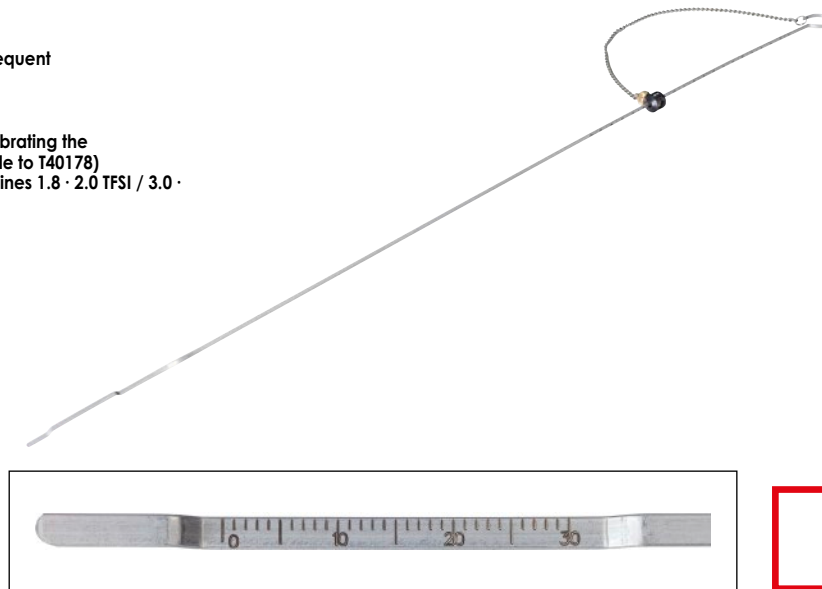
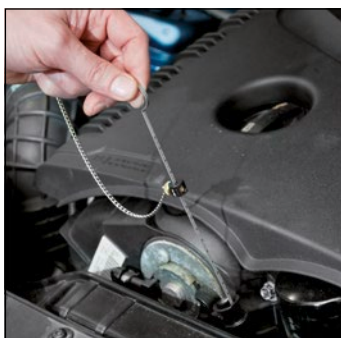

V6027, EAN 4047728060271

Oil filling adapter set

- Uncomplicated filling of engine oil into the engine filler neck
- Adapter set made of durable aluminium
- Five different adapters for almost every vehicle
- No overflowing
- Plastic funnel with 1 l capacity
- Angle extension enables simple filling of narrow areas



Now also with new B2 adapter for VW Golf 7 · SEAT León (5F) · ŠKODA Octavia 3 etc.



V2511N, EAN 4047728068239

Oil filter strap wrench

- Installation and removal of oil filters
- Infinitely adjustable
- Setting to filter Ø by turning on the end of the handle
- Ergonomic handle



V2521, EAN 4047728025218

Spare strap

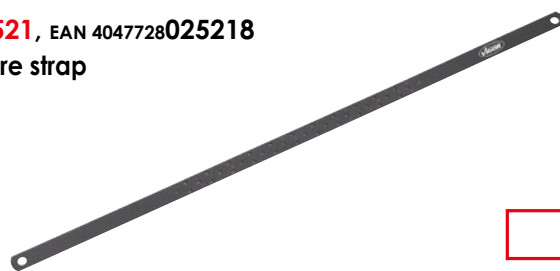

V1281, EAN 4047728012812

Oil filter claw wrench

- Optional drive:
 - ▣ 1 1/2" inside square or 21 mm
 - outside hexagon
- 1 Adapter 1 3/8" outside square, 1 1/2" inside square, with outside hexagon size 21 mm

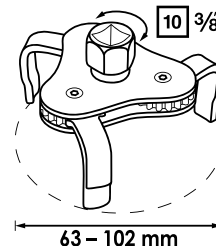

Continuous interlinking



V4413, EAN 4047728044134

Oil filter wrench, 60–80 mm, universal

- Infinitely adjustable
- Use with wrench size 21 mm or $\frac{1}{2}$ " reversible ratchet
- Optimal hold when loosening the oil filter thanks to left-toothed jaws
- For oil filters in areas with restricted access
- Clockwise/anti-clockwise application enables operation of the screw connection

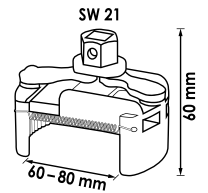

V4414, EAN 4047728044141

Oil filter wrench, 80–115 mm, universal

- Mechanical locking of the oil filter wrench simplifies subsequent attachment of the reversible ratchet to the oil filter wrench. The oil filter clamping wrench always remains under tension when the reversible ratchet is moved backwards
- Infinitely adjustable
- Use with wrench size 21 mm or $\frac{1}{2}$ " reversible ratchet
- Optimal hold when loosening the oil filter thanks to left-toothed jaws
- For oil filters in areas with restricted access
- Clockwise/anti-clockwise application enables operation of the screw connection

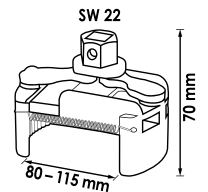

V4415, EAN 4047728062114

Oil filter wrench, 115 – 140 mm, universal

- Infinitely adjustable
- Use with wrench size 21 mm or $\frac{1}{2}$ " reversible ratchet
- Optimal hold when loosening the oil filter thanks to left-toothed jaws
- For oil filters in areas with restricted access
- Clockwise/anti-clockwise application enables operation of the screw connection

NEW

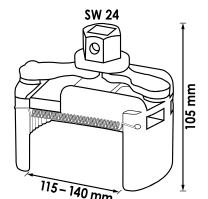

V4484, EAN 4047728044844

Special screwdriver bit

- Installing / removing the VAG plastic oil drain plug with special profile on oil pans
- For e.g.:
AUDI · SEAT · ŠKODA · VW
Model years 2013 → with 1.2 · 1.4 · 1.8 · 2.0 TFSI petrol engines
AUDI A1, A3, A4, A5, Q5,
SEAT León, etc. with 1.6 and 2.0 l diesel engines
VW Golf 7



6.3 1/4"



V4369, EAN 4047728043694

Vacuum pump

- Suction intake and decanting of fuels, oils and other liquids
- Capacity: 350 ml
- For the following liquids among others:
 - Diesel fuels
 - Petrol
 - Brake fluid
 - Antifreeze
 - Engine oil
 - Transmission oil
 - Power steering oil
- Contents:
 - 1 x hand pump 350 ml
 - 1 x PVC hose \varnothing 9.8x300 mm
 - 1 x silicone hose \varnothing 11x300 mm
 - 1 x drip plug
 - 1 x universal adapter



5

V4201, EAN 4047728042017

Vacuum pump

- Manual vacuum pump for extracting and filling vehicle fluids
- Pre-filling fuel filter in vehicles without a pre-filter pump, e.g. the 2.0 l TDI FORD Galaxy and Mondeo
- Capacity: 1.5 l
- For the following liquids:
 - Diesel fuels
 - Petrol
 - Brake fluid
 - Antifreeze
 - Engine oil
 - Transmission oil
 - Power steering oil

Suitable for all fuel types

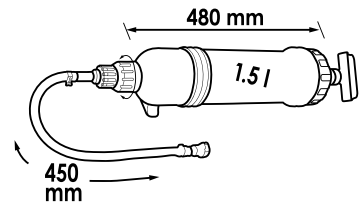

6

5 adapters included



Scale indication



V4201-1, EAN 4047728056588
Gasket set for V4201



3



V4385, EAN 4047728**043854**

Oil filling device with adapter set

- Filling gearboxes and differentials with oil
- Incl. oil pan and 16 adapters for vehicles with extremely restricted installation spaces

Greatest market coverage



18

Viscosity up to SAE 140



With return function

Hose length: 1600 m

Capacity: 7.5 l

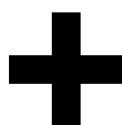

16 adapters included



VIGOR No.	Designation	EAN 4047728+
①	V3681 Adapter FORD with threaded connection	036818
②	V3682 Adapter BMW bent	036825
③	V3683 Adapter VAG short, bent	036832
④	V3684 Adapter VAG long, bent	036849
⑤	V3685 Adapter VAG straight, with threaded connection	036856
⑥	V3686 Adapter MERCEDES-BENZ, 7-gear automatic transmission	036863
⑦	V3687 Adapter VAG DSG direct shift gearbox	036870
⑧	V3688 Adapter VAG CVT, continuously variable transmission	036887
⑨	V3689 Adapter Volvo, straight	036894
⑩	V3690 Adapter ŠKODA, M 18x1.5 mm	036900
⑪	V3691 Adapter VW Passat from model year 2007 onwards	036917
⑫	V4113 Adapter TOYOTA, LEXUS 18x1.5	041133
⑬	V4114 Adapter Infiniti 7 speed M8x1.0 for V2670	041140
⑭	V4115 Multifunction adapter	041157
⑮	V4383 Adapter NISSAN Juke, M12x1.25 mm	043830
⑯	V4384 Adapter for MINI Cooper M14x1.5 mm	043847

Can also be ordered as spare part

V3550, EAN 4047728**035507**
Replacement container for oil filling device V4385





V6300-5, EAN 4047728068963

Oil drain pan

- Collection / transfer of liquids such as oil, brake fluid or water
- The outlet opening is fitted with a web and prevents uncontrolled overflow of the liquid being refilled
- The litre scale in the pan indicates the filled quantity
- Practical holding device for oil filter cartridges allows smooth emptying
- Oil drain pan with hanging hole for easy storage on perforated tool panels
- Smooth plastic surface for quick and easy cleaning
- Capacity: 5 l



Practical holding device for storing oil filter cartridge

NEW

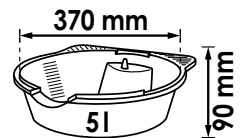

V6300-8, EAN 4047728068970

Oil drain pan

- Collection / transfer of liquids such as oil, brake fluid or water
- The outlet opening is fitted with a web and prevents uncontrolled overflow of the liquid being refilled
- The litre scale in the pan indicates the filled quantity
- Practical holding device for oil filter cartridges allows smooth emptying
- Oil drain pan with hanging hole for easy storage on perforated tool panels
- Smooth plastic surface for quick and easy cleaning
- Capacity: 8 l



Practical holding device for storing oil filter cartridge

NEW

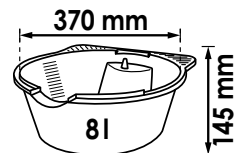

V6300-13, EAN 4047728068956

Oil drain pan

- Collection / transfer of liquids such as oil, brake fluid or water
- The outlet opening is fitted with a web and prevents uncontrolled overflow of the liquid being refilled
- The litre scale in the pan indicates the filled quantity
- Practical holding device for oil filter cartridges allows smooth emptying
- Oil drain pan with hanging hole for easy storage on perforated tool panels
- Smooth plastic surface for quick and easy cleaning
- Capacity: 13 l



Practical holding device for storing oil filter cartridge

NEW

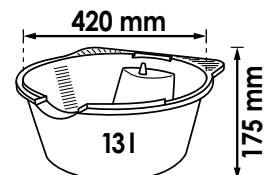





Brakes

Brake maintenance and bleeding 302–305

Brake piston readjusting tools 306–308

Brake discs tools 309

Tube flaring tools 310–313

Inspection tools 314–317



V3228, EAN 4047728**032285**

ABS reamer set

- Reaming corroded, stuck ABS sensors
- 1 ratchet with hinge joint (clockwise only) with quick-change function, 5 reamers as well as one twist drill \varnothing 10 mm x 133 mm
- Note: when defective ABS sensors are replaced, residues of torn-off sensors may remain which are difficult to remove. For correct installation of new sensors, the seats of the sensors in the wheel bearing housing must be cleaned with the appropriate reamers
- 5 reamers:
 - V3695 reamer \varnothing 10 x 133 mm:
VW Golf 5 · Polo 9N · T5 ŠKODA Fabia · SEAT Ibiza · OPEL/VAUXHALL Insignia
 - V3694 reamer \varnothing 14 x 32 mm:
BMW E38 · E39 · E52 · E60 · E61 · E63 · E64 · E65 · E66 · E70 · E71
 - V3699 reamer \varnothing 15 x 23 mm:
MERCEDES-BENZ A-Class · MAZDA · FORD
 - V3698 reamer \varnothing 18 x 23 mm:
AUDI · VW · BMW E36 · E46 · SEAT · ŠKODA
 - V3697 reamer \varnothing 18 x 34 mm:
AUDI · VW · SEAT · ŠKODA · commercial vehicles

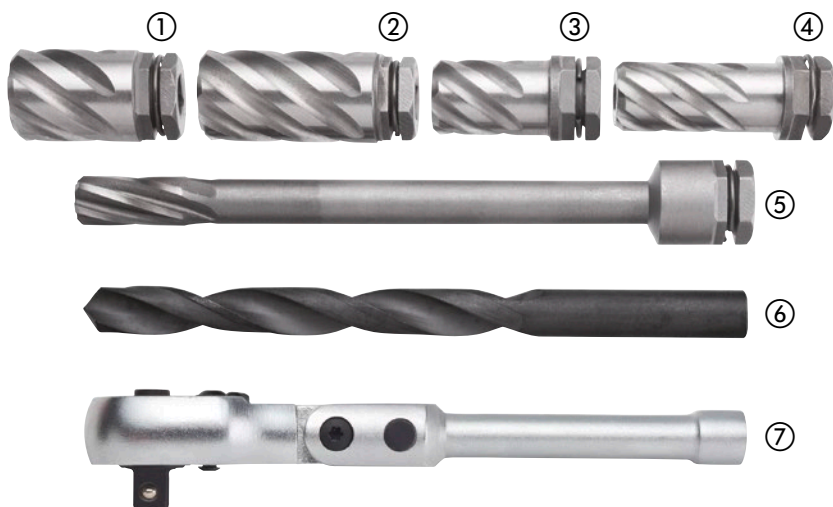
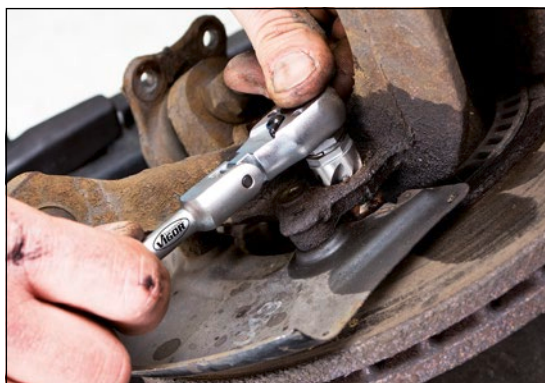

	VIGOR No.	Designation	EAN 4047728+
①	V3698	Reamer \varnothing 18x23 mm	036986
②	V3697	Reamer \varnothing 18x34 mm	036979
③	V3699	Reamer \varnothing 15x23 mm	036993
④	V3694	Reamer \varnothing 14x32 mm	036948

	VIGOR No.	Designation	EAN 4047728+
⑤	V3695	Drill (reamer) \varnothing 133x10 mm	036955
⑥	V3696	Drill \varnothing 10x133 mm	036962
⑦	V3693	Reversible ratchet with hinge joint ■ 6.3 = 1/4"	036931

V4381, EAN 4047728043816

Adapter for brake service systems

- Together with conventional brake service devices
- Cover made from durable aluminium
- Contents

- ① Adapter E 20 W for expansion tanks with restricted access, for almost all European vehicles
- ② Adapter G 75 for ISUZU · MITSUBISHI · PROTON · SUBARU · SUZUKI · Volvo · KIA
- ③ Adapter B 35 for CHRYSLER · FORD · NISSAN · SUBARU · HYUNDAI
- ④ Universal adapter with chain fixation

Simple and useful supplement
for using service devices
on almost all vehicles



Bayonet fitting

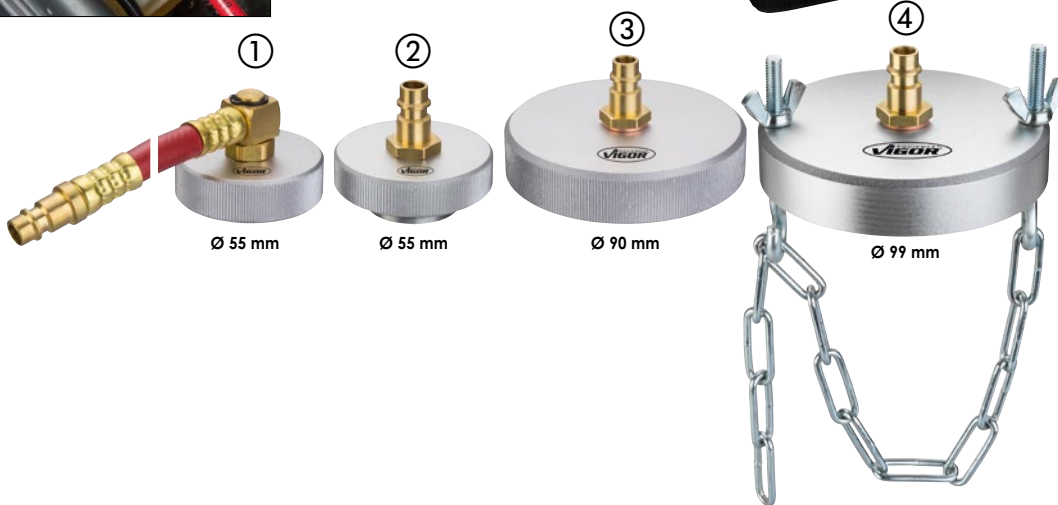

V4381-1, EAN 4047728046930

Adapter for brake service systems

- Adapter: 55 mm Ø
- For expansion tanks with restricted access, for almost all European vehicles
- To be used together with conventional brake service devices
- Adapter thread: M 46.5 x P 3.5

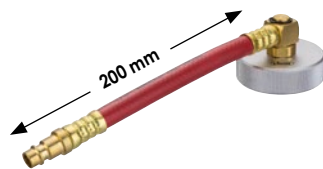

V4381-2, EAN 4047728046947

Adapter for brake service systems

- Adapter: 55 mm Ø, with bayonet fitting
- For FORD · ISUZU · MITSUBISHI · PROTON · SUBARU · SUZUKI · Volvo
- To be used together with conventional brake service devices
- Lock size: Ø 33 mm



V4381-3, EAN 4047728046954

Adapter for brake service systems

- Adapter: 90 mm Ø
- For CHRYSLER · FORD · NISSAN · SUBARU · HYUNDAI
- To be used together with conventional brake service devices
- Adapter thread: M 79.5 x P 30



V4381-4, EAN 4047728046961

Adapter for brake service systems

- Adapter: 99 mm Ø
- To be used together with conventional brake service devices
- Lock size: Ø 78.1 mm



V4411, EAN 4047728044110

Brake bleeder set 3 l, manual

- Bleeding brake and coupling systems
- Working pressure: max. 1.4 bar
- Manometer range: 0–2 bar
- Draining of the pressure through integrated pressure relief valve
- Contents:
 - 3 litre tank
 - E20 Euro adapter
 - Universal adapter with chain
 - Connecting hose with quick connection
 - Collection tank with connection nipple for brake systems

Especially suited for mobile use with manual pressure build-up function



Capacity: 3 litres



V4668, EAN 4047728046688

Brake fluid tank

- Collection tank for bleeding brake and coupling systems
- Silicone tube, length: 550 mm
- Contents of V4411

Suitable for all common bleeding valves



Capacity: 700 ml

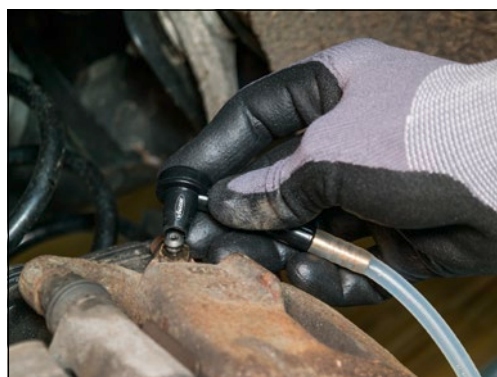

V4648, EAN 4047728046480

Funnel, universal

- Filling with liquids
- Including filter with filter size of 20 mesh
- Additional function ensures that the oil tank lock can be opened safely without the oil flowing uncontrolled out of the tank
- Adjustable retaining ring allows for use of standard funnels
- Flexible use through span width of 28–74 mm Ø
- Suitable for the following liquids among others:
 - Diesel fuels
 - Petrol
 - Brake fluid
 - Antifreeze
 - Engine oil
 - Transmission oil
 - Power steering oil



With self-locking function

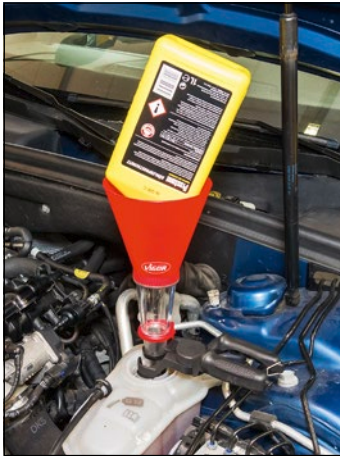

V4644, EAN 4047728046442

Brake bleeding set

- Brake bleeding without removing the wheels
- Including fine-tooth reversible ratchet for actuating the ventilation pin
- Silicone ventilation hose allows for strong grip on ventilation nipple
- Contents:
 - 1 x fine-tooth reversible ratchet
 - 1 x silicone ventilation hose 1.40 m
 - 1 x socket (6-point), short size 10 mm
 - 1 x socket (6-point), short size 11 mm
 - 1 x socket (6-point), long size 10 mm
 - 1 x socket (6-point), long size 11 mm



Open construction of the reversible ratchet and sockets makes it possible to guide the ventilation hose

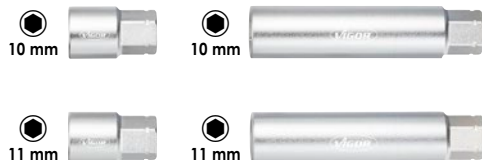
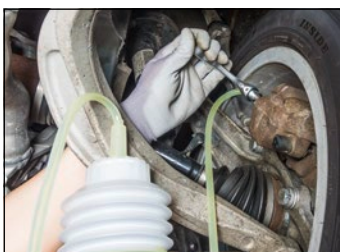
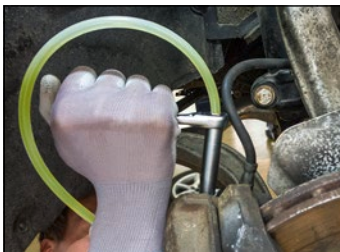

V4644-1, EAN 4047728049290

Hose

- Spare hose for V4644



NEW

V3760N, EAN 4047728**066310**

Brake piston readjusting tool set

- Clockwise and anti-clockwise brake pistons
- Including 4 special sockets
- Reset by pressing and simultaneously turning the brake piston
- Numbering of the adapter plates enables precise allocation
- Magnetic spindle sockets enable comfortable work
- Contents:
 - 2 spindles (anti-clockwise and clockwise)
 - 2 hex-head wrenches (6 and 7 mm)
 - 2 drift pins
 - 3 exchangeable reaction plates
 - 36 reaction plates and adapters
 - 4 special brake fitting sockets
 - 1 spindle grease
- Adapters enable use even on very worn brake linings and assembly of the back plate in the break calliper



VIGOR No.	Designation		EAN 4047728+
V3760-0	Adapter 0 for retrofitting the individual sets		067010
V3760-0-DISC	Adapter 0-DISC		067027
V3760-1	Adapter 1		067164
V3760-2	Adapter 2 for CITROËN XM · Xantia		066853
V3760-3	Adapter 3 for ALFA ROMEO · AUDI · AUSTIN · BMW · FORD · HONDA · JAGUAR · MERCEDES-BENZ · MITSUBISHI · NISSAN · LAND ROVER · TOYOTA · VW For front brake pistons, where only pressure is required. With 3 levels to prevent damage to the sealing boots.		067201

VIGOR No.	Designation		EAN 4047728+
V3760-4	Adapter 4 for ALFA ROMEO 164 · FORD · MAZDA · SAAB · SUBARU		066631
V3760-5	Adapter plate 5		066648
V3760-6	Adapter plate 6 for NISSAN Primavera · VW Golf 4 · T4 · T5 · FIAT Bravo (198) model years 2007 →		066655
V3760-7	Adapter 7 for AUDI 80 · 90 · 100 · V8 · MAZDA · MITSUBISHI · TOYOTA · FORD Sierra ABS · Scorpio model years 1985 → · HONDA Prelude · GENERAL MOTORS · NISSAN Silvia 1.8 turbo · LAND ROVER 8000 · SAAB 9000 · SUBARU L · Z · VW Golf · Passat		066662
V3760-8	Adapter 8 for FORD · HONDA · BMW · VAG · CITROËN · MERCEDES-BENZ		066990

Brake piston readjusting tools



VIGOR No.	Designation		EAN 4047728+	VIGOR No.	Designation		EAN 4047728+
V3760-9	Adapter 9 for GENERAL MOTORS		067003	V3760-K	Adapter plate K for CITROËN C5		067034
V3760-A	Adapter A for new RENAULT models		066693	V3760-K1	Adapter plate K1		066778
V3760-A1	Adapter plate A1		067089	V3760-K2	Adapter plate K2		066785
V3760-B	Adapter plate B		066709	V3760-M	Adapter plate M for FORD		066792
V3760-B1	Adapter B1		067096	V3760-N	Adapter N		067041
V3760-B2	Adapter B2		067140	V3760-P	Adapter P		066808
V3760-C	Adapter plate C		066716	V3760-P1	Adapter plate P1		067119
V3760-D	Adapter plate D		066723	V3760-Q	Adapter plate Q for ALFA ROMEO · FIAT · FORD		066815
V3760-E	Adapter plate E		066730	V3760-R	Adapter plate R		066822
V3760-F	Adapter plate F for PEUGEOT 206 model years 2003 →		066747	V3760-R1	Adapter R1		067126
V3760-F1	Adapter plate F1		067102	V3760-S	Adapter plate S		066839
V3760-F2	Adapter F2		067157	V3760-T	Adapter plate T		066952
V3760-G	Adapter plate G		066754	V3760-V	Adapter plate V		066969
V3760-G1	Pressure plate G1 for expansion of the brake piston readjusting tool sets		067133	V3760-X	Adapter X		066976
V3760-H6	Adapter H6		067065	V3760-Z	Adapter plate Z		066983
V3760-H7	Adapter H7		067072	V3760-11	Adapter 11		066679
V3760-IV	Adapter IV		067058	V3760-12	Adapter 12		066686
V3760-J	Adapter plate J for ALFA ROMEO · AUDI · CITROËN · FIAT · FORD · HONDA CRX · JAGUAR · LANCIA · NISSAN · PEUGEOT 306 · RENAULT Master · LAND ROVER · SAAB · SEAT · VW Passat · T4 · Volvo S40 · V40		066761				



V1711N, EAN 4047728060738

Brake piston readjusting tool set, pneumatic

- Pushing and turning brake pistons on nearly all passenger cars
- Efficient, damage-free working on brake systems
- For clockwise and anti-clockwise brake pistons
- In addition to pneumatic support, controlled rewinding by hand is also possible
- Quick-connectors allow adapters to be mounted easily
- Automatic balancing of different thread pitches
- Set with 23 pieces consisting of:
 - 1 pneumatic spindle and 22 adapter plates

23



Now even greater market coverage!



V4930, EAN 4047728**049306**

Calliper gauge for brake discs

- Fast, effective determination of the brake disc diameter without removing the wheel first
- Time saving through clear identification of the installed brake system (advantage: fewer incorrect orders)
- Universal clamping range: 200–400 mm

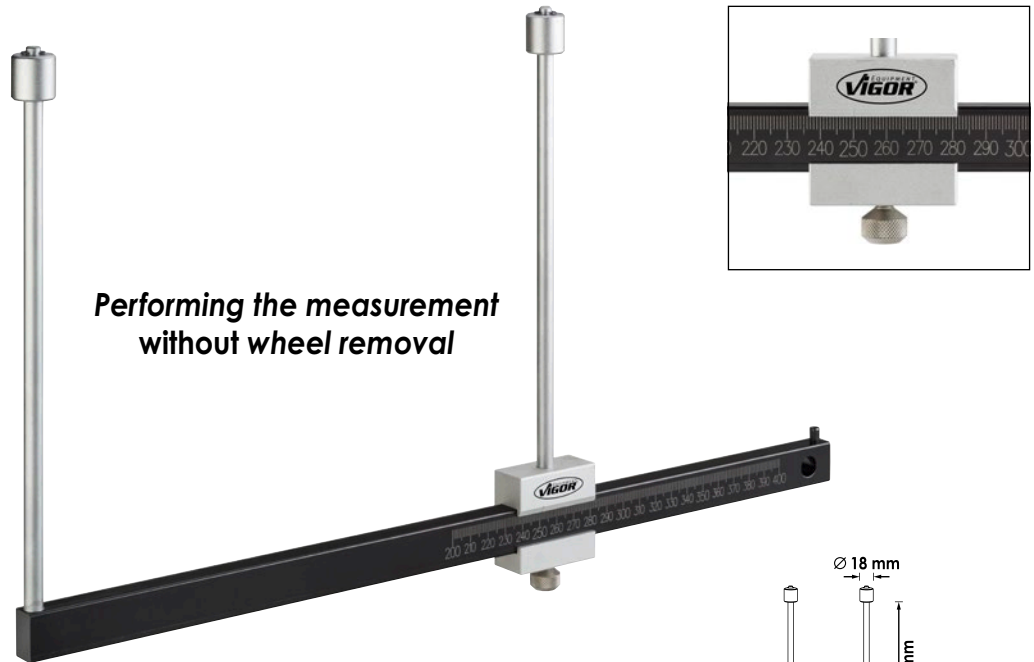

Performing the measurement without wheel removal

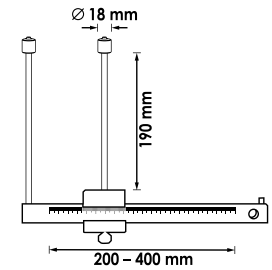

V4399, EAN 4047728**043991**

Brake disc thickness gauge

- Fast, efficient test for determining the current brake disc thickness
- Note: see the manual of the vehicle manufacturer for the minimum wear limits of the brake discs

Display range 0 – 45 mm

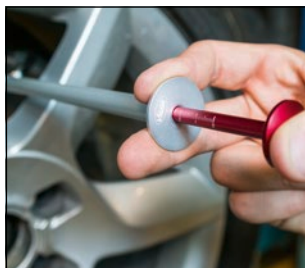
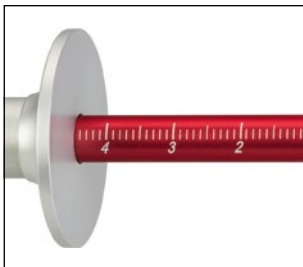

Performing the measurement without wheel removal

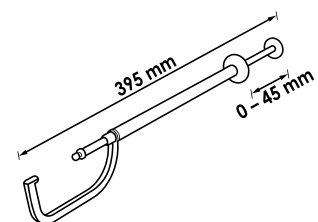

V4416, EAN 4047728044165

Tube flaring tool for Ø 4.75 mm

- Exclusively for DIN flaring
- Lightweight and easy to handle
- Exact positioning of the brake line in the device using a spacing adapter
- Application on brake and hydraulic lines directly on vehicles
- For thin-walled pipes made of steel, aluminium and copper (metric / inch)
- No damage to coated lines
- For DIN "F" flares 180°



For DIN "F" flares

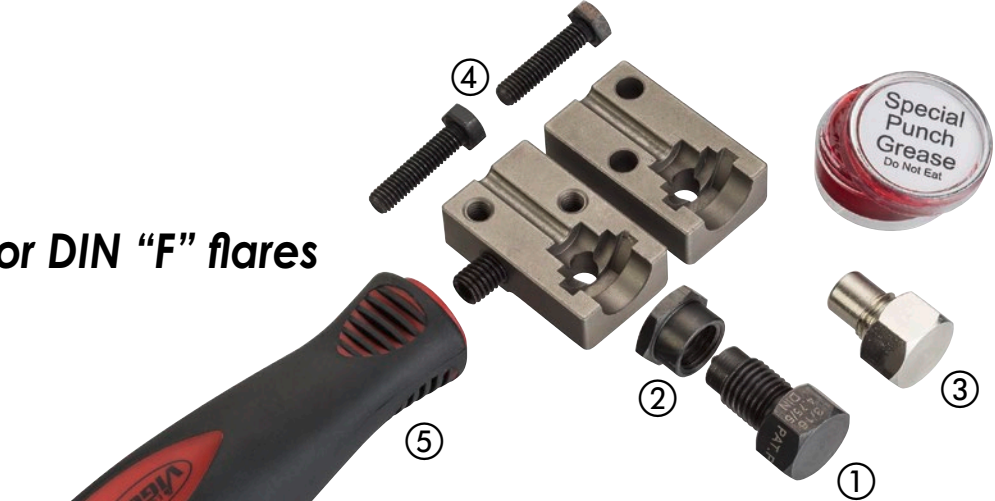

Particularly suited for direct use on the vehicle!



	VIGOR No.	Designation	EAN 4047728+
①	V4416-1	DIN flaring screw 4.75 mm	049313
②	V4416-2	Screw sleeve	049337
③	V4416-3	Spacing adapter	049344
④	V4416-4	Bolt	049351
⑤	V4416-5	Handle for V4416	049375

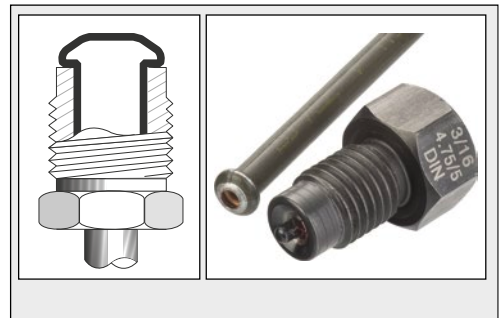

DIN



V4697, EAN 4047728**046978**

Tube flaring tool for \varnothing 4.75 mm

- Flared tube ends of \varnothing 4.75 mm lines according to DIN and SAE standards
- Extremely small construction ensures that it is possible to work in confined spaces
- No damage to coated lines
- Distance adapter prevents incorrect positioning of the brake line
- For steel, aluminium and copper lines
- For 180° DIN "F" flares, as well as SAE "F" double flares

- Contents:
- 1 basic unit
 - 1 DIN flare adapter
 - 1 SAE flare adapter
 - 1 distance adapter
 - 1 special grease



**For DIN · SAE
and F flares**



Particularly suited for direct application on the vehicle due to easy handling



VIGOR No.	Designation	EAN
① V4416-1	DIN flaring screw 4.75 mm	049313
② V4416-2	Screw sleeve	049337
③ V4416-3	Spacing adapter	049344
④ V4416-4	Bolt	049351
⑤ V4697-1	SAE flaring screw 4.75 mm	049320
⑥ V4697-2	Handle	049368

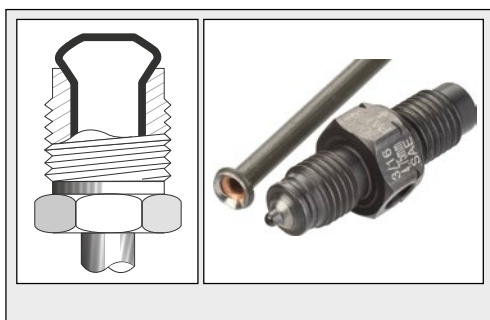

SAE

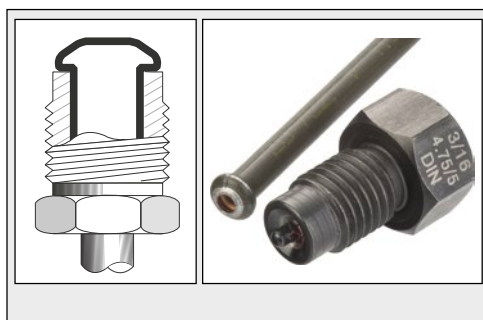

DIN



V1728, EAN 4047728017282

Tube flaring tool set

- Direct application on brake and hydraulic lines on vehicles
- For thin-walled pipes made of steel, aluminium and copper (metric / inch)
- Producing convex and double flares (DIN/SAE standards)
- No damage to coated lines
- For 180° DIN "F" flares and SAE "F" double flares, as well as simple "D" flares



For DIN · SAE flares

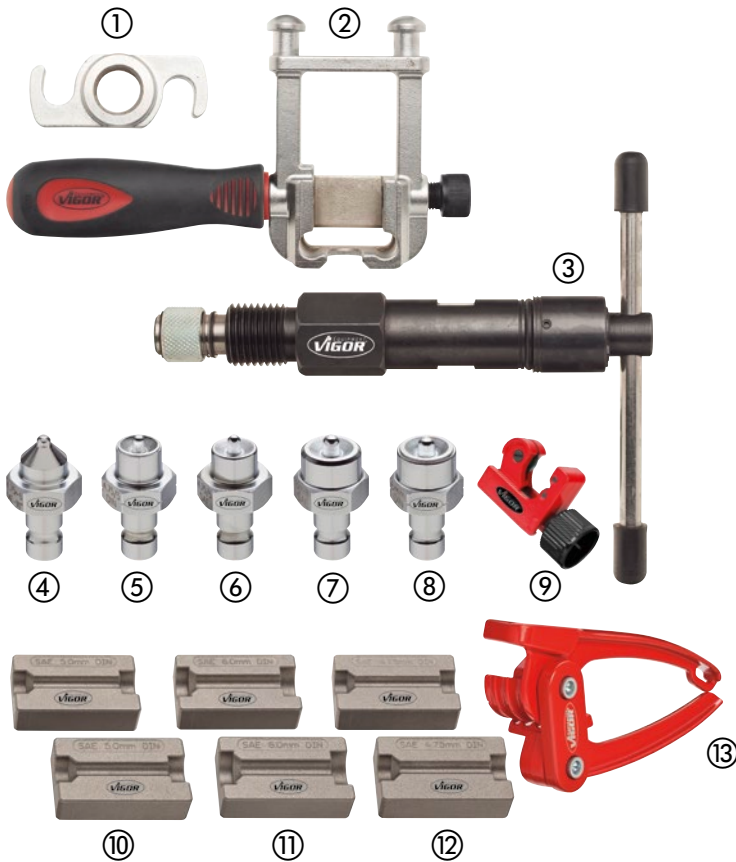

	VIGOR No.	Designation	∅ mm	EAN 4047728+
①	V2466	Quick-change holder	-	024662
②	V2559	Basic unit	-	025591
③	V2467	Hydraulic spindle	-	024679
④	V2558	Thrust block 90° DIN / SAE	4,75-6	025584
⑤	V2553	Thrust block DIN / SAE	5	025539
⑥	V2554	Thrust block DIN / SAE	4,75	025546
⑦	V2556	Thrust block DIN / SAE	6	025560

	VIGOR No.	Designation	∅ mm	EAN 4047728+
⑧	V2555	Thrust block DIN / SAE	6	025553
⑨	V2626	Tube cutter, 3-16 mm	3-16	026260
⑩	V2551	Pair of gripping jaws	5	025515
⑪	V2552	Pair of gripping jaws	6	025522
⑫	V2540	Pair of gripping jaws	4,75	025409
⑬	V1782	Tube bending tool	-	017824



V5513, EAN 4047728055130

Tube flaring tool set

- Flaring steel, aluminium or copper brake lines with \varnothing 4.75 · 5 · 5.15 · 5.25 · 6 mm
- Modern BMW and VAG brake lines are covered with an additional plastic layer (\varnothing 5.15 / 5.25 mm)
- Flaring is not possible with standard tube flaring tools
- Exclusively for DIN flaring
- Direct application on brake and hydraulic lines on vehicles



12



	VIGOR No.	Designation	EAN 4047728+
①	V5513-1	DIN flaring screw 6 mm	055147
②	V5513-2	Line cutter 3 – 16 mm	055154
③	V5513-3	Line scraper 3 – 16 mm	055161
④	V4416-1	DIN flaring screw 4.75 mm	049313
⑤	V4416-2	Screw sleeve	049337
⑥	V4416-3	Spacing adapter	049344
⑦	V4416-4	Bolt	049351
⑧	V4697-2	Handle	049368
⑨	V1782	Tube bending tool	017824

For new VAG and BMW brake lines with additional covering

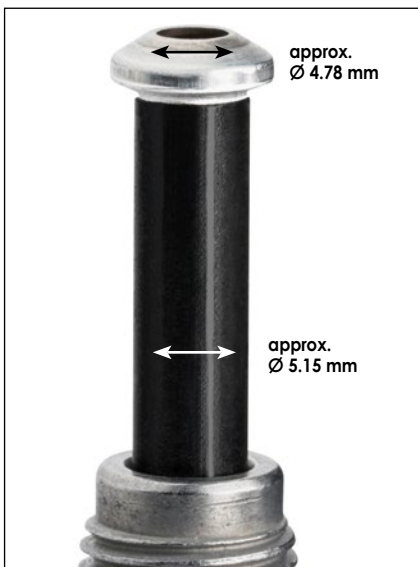

New brake line



Positioning of line to scrape the covering



Mounting the union nut

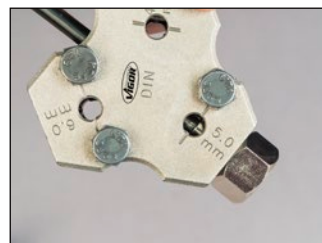

Positioning the line



DIN flaring process



V5649, EAN 4047728056496

Deburrer for brake lines, inside/outside

- For deburring of brake lines
- For inside pipe \varnothing 3 – 12 mm
- For outside pipe \varnothing 4 – 14 mm
- For deburring of brake lines
- For steel, copper, stainless steel, aluminium lines

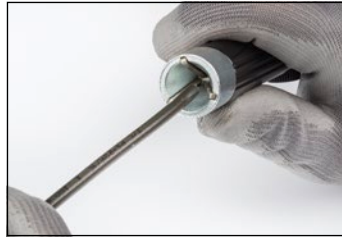
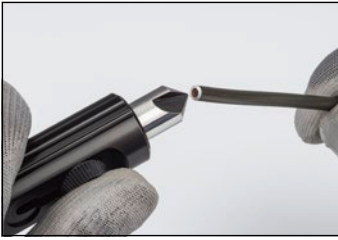

V5909, EAN 4047728059091

Brake hook

- For hanging up the brake calliper during work on brakes (damage to the brake hose prevented)
- Also for hanging up hoses or cables
- Dip-insulated surface

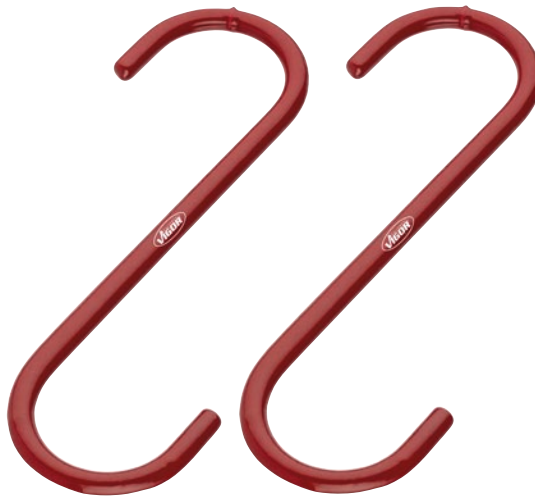

V2789N, EAN 4047728062824

Brake and fuel line inspection tool

- Detection of hidden corrosion during general inspection
- 12 cleaning edges for removal of dirt and rust from various lines
- \varnothing 3.5 mm · 4.0 mm · 4.75 mm

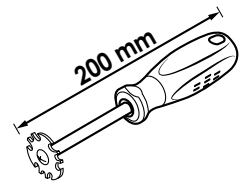

V5691, EAN 4047728056915

Brake calliper file

- For removing brake dust, rust and dirt from the brake calliper without damaging the brake sleeves
- Extremely narrow design allows high flexibility
- All four sides of the square are toothed with 2 different thicknesses
- Diameter square: 9 mm

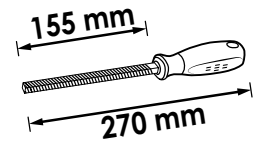

V2411, EAN 4047728024112

Brake calliper file

- For removing brake dust, rust and dirt from the brake calliper

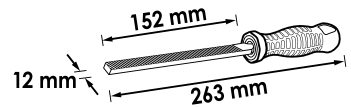

V2250, EAN 4047728022507

Brake calliper brush, steel

- Removal of stubborn brake dust
- Very slim design



With hanging hole



V2249, EAN 4047728022491

Brake calliper brush, brass

- Cleaning aluminium brake callipers
- Removal of stubborn brake dust
- Allows access into small brake callipers



With hanging hole



V1782, EAN 4047728017824

Tube bending tool

- For tubes made of copper, brass, aluminium and soft steel
- Can be bent up to 90°
- Bending pipes measuring 3 mm, 4.75 mm and 6 mm Ø



6 mm Ø
4/4.75 mm Ø
3 mm Ø



V3730, EAN 4047728037303

Line wrench set

- For screw connections on brake, fuel, hydraulic and air-conditioning lines
- Wrench head ends work like spring hinges
- Worn, damaged or too small screw connections are firmly enclosed
- Clamping mechanism depending on torque:
The higher the torque, the more powerful the clamping
- Adapts to metric as well as inch sizes
- □ drive 10 = 3/8" for extra leverage

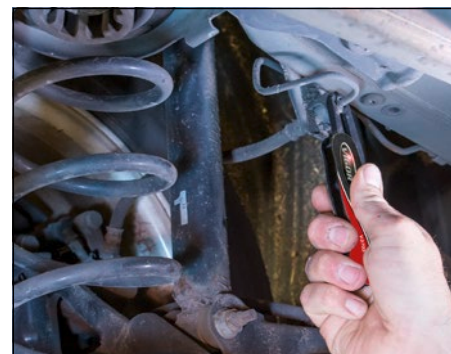

VIGOR No.	Size mm	EAN 4047728+
V3703	10	037037
V3704	11	037044
V3705	12/13	037051
V3706	14	037068







Wheels / tyres

Impact sockets	319–321
Service jacks and jack stands	322–324
Wheel /tyre tools	325–329



Impact sockets



V4309, EAN 4047728043090

Impact socket, MERCEDES-BENZ

- Operating wheel bolts with a MERCEDES-BENZ special profile
- For MERCEDES-BENZ, e.g.:
C-Class · GLK (W204),
E-Class (W211, W212, W207),
SLK (W172),
M-Class (W164, W166),
CL-Class (W216),
S-Class (W221, W222)
MAYBACH

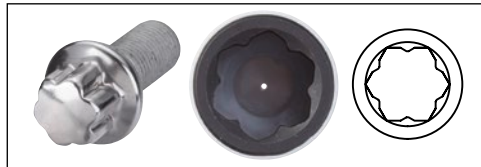

12⁵ 1/2"



V5930, EAN 4047728059305

Impact socket, long

- Damage-free operation of wheel bolts by rotating plastic sleeve

Size 17 mm



12⁵ 1/2"



Comparison of standard socket with extra long socket

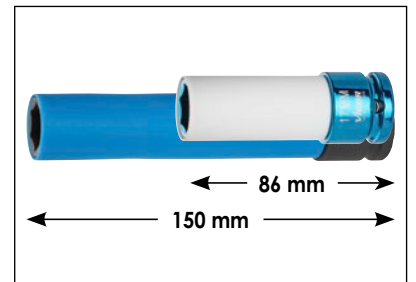

V5931, EAN 4047728060318

Impact socket, long

- Damage-free operation of wheel bolts by rotating plastic sleeve

Size 19 mm



12⁵ 1/2"

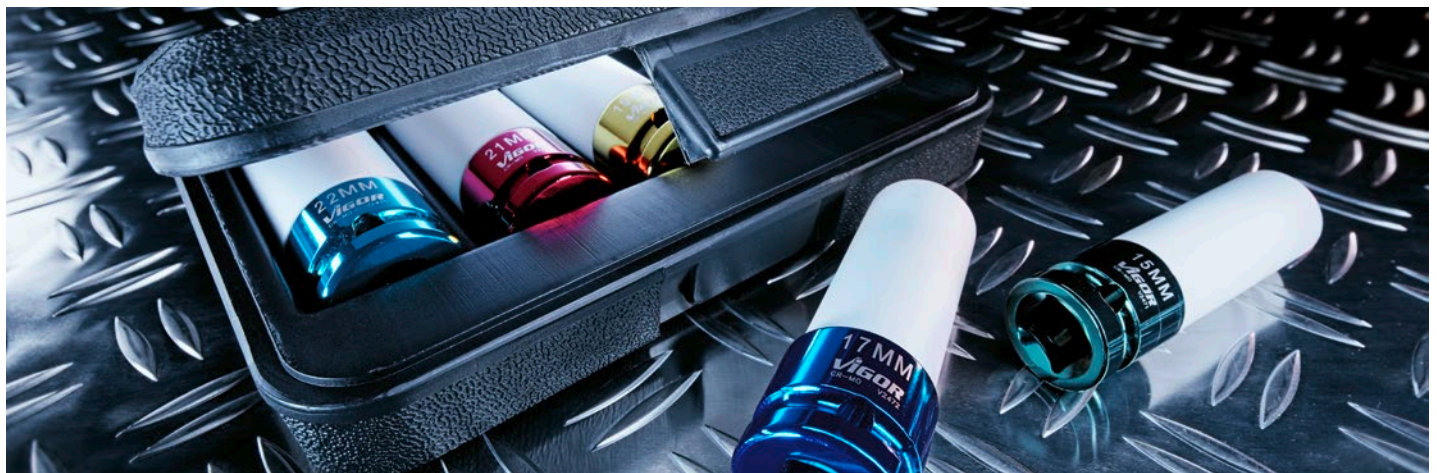

V4431, EAN 4047728**044318**

Tyre pressure control systems (TPCS) tool set

- Easy, professional installation of TPCS sensor and valve on every rim
- Including 2 torque screwdrivers for precise tightening torques of 0.2–2 Nm and 2–10 Nm
- Installing and removing tyre valve cores



6.3 1/4" 6.3 1/4"



	VIGOR No.	Size mm	L mm	EAN 4047728+
①	V4431-1	1/4" 2-10 Nm	190	044325
②	V4431-2	1/4" 0,2-2 Nm	190	044332
③	V2700	● 12	50	027007
④	V2699	● 11	50	026994
⑤	V2453	1/4" 1/4"	110	024532
⑥	V4431-3	-	55	044349
⑦	V4431-4	T10	55	044356
⑧	V4431-5	T15	55	044363
⑨	V4431-6	T20	55	044370

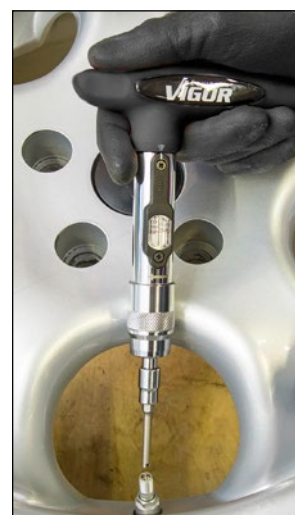

Impact sockets



V7039, EAN 4047728070393

Impact socket set

- Damage-free operation of wheel bolts with plastic sleeve



VIGOR No.	Size mm	mm	EAN 4047728+
V7039-17	17	87	070409
V7039-19	19	87	070416
V7039-21	21	87	070423



12⁵ 1/2"

3

NEW



V2522, EAN 4047728025225

Impact socket set



VIGOR No.	Size mm	mm	EAN 4047728+
V2472	17	85	024723
V2473	19	85	024730
V2474	21	85	024747



12⁵ 1/2"

3



V2257, EAN 4047728022576

Impact socket set



VIGOR No.	Size mm	mm	EAN 4047728+
V2471	15	85	024716
V2472	17	85	024723
V2473	19	85	024730
V2474	21	85	024747
V2475	22	85	024754



12⁵ 1/2"

5



V6028, EAN 4047728**060288**

Hydraulic service jack 2 tonnes, ultra-flat

- Tyre change on the vehicle or repairs under the vehicle, for which a lifting platform is not necessary
- \approx 32 kg

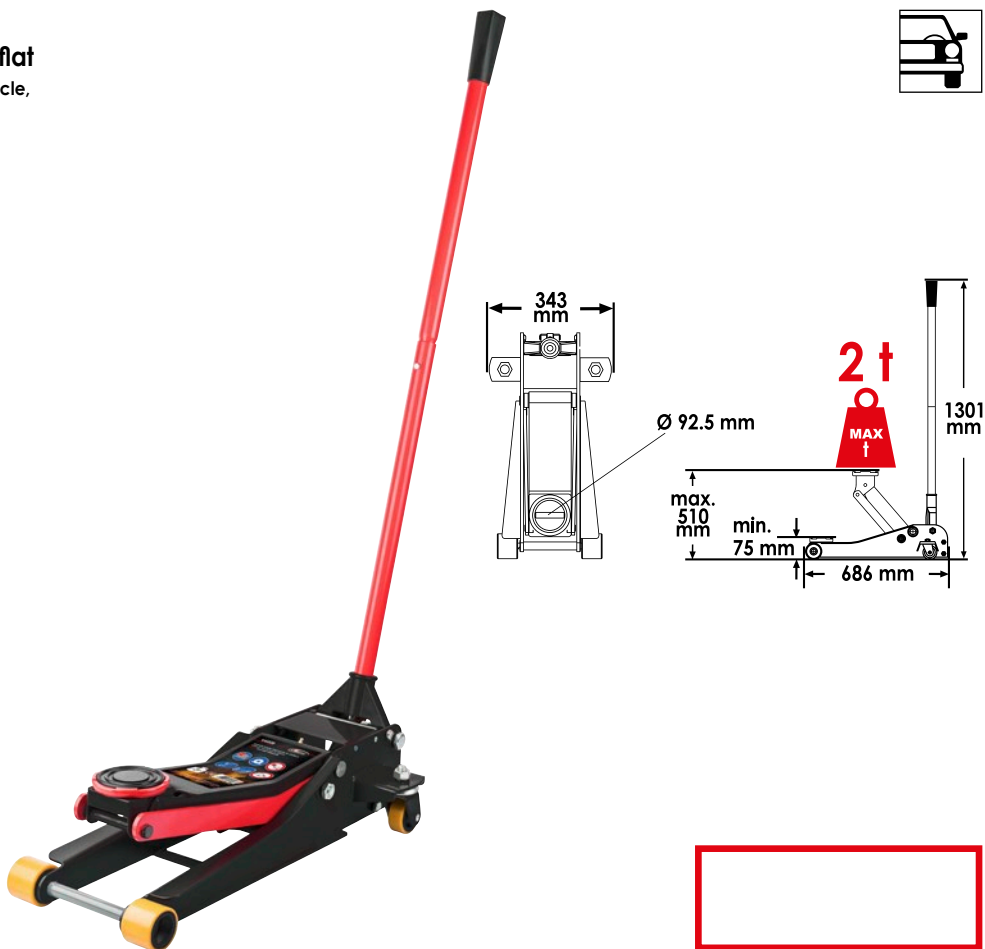

V2481, EAN 4047728**024815**

Hydraulic aluminium service jack 1.35 tonnes

- Tyre change on the vehicle or repairs under the vehicle, for which a lifting platform is not necessary
- \approx 10 kg

**Aluminium –
only 10 kg**

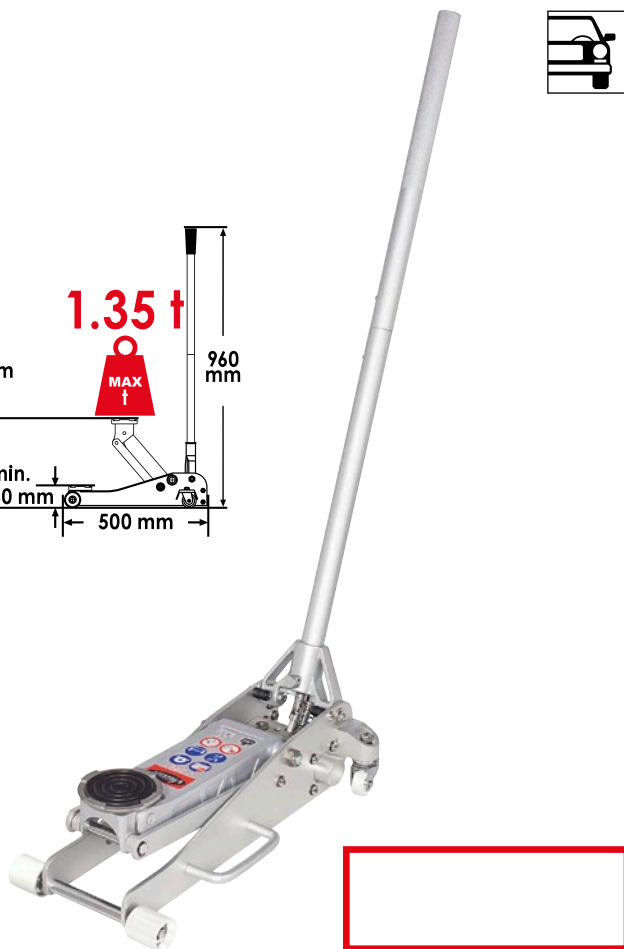
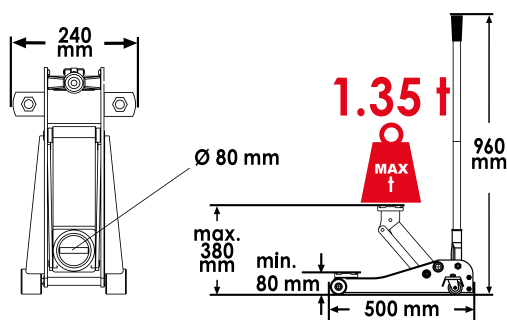
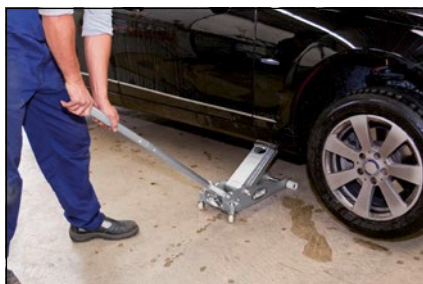

VIGOR No.	Designation	EAN 4047728+
V2631	Pair of fixed castors	026314
V2632	Pair of swivel castors	026321
V2639	Hydraulic unit	026390
V2640	Rubber pad	026406

V6029, EAN 4047728**069786**

Hydraulic service jack 3 tonnes

- Tyre change on the vehicle or repairs under the vehicle, for which a lifting platform is not necessary
- \approx 31 kg
- Solid rubber pad for firm hold
- Fast lift thanks to turbo-lift function
- Robust steel body – guarantees high quality
- Compact design
- Quiet plastic rollers

NEW

Foot pedal enables quick attachment to the service jack point

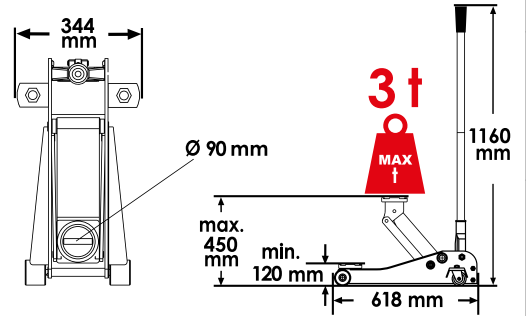

V2478, EAN 4047728**024785**

Hydraulic bottle jack 6 tonnes

- Vertical and horizontal applications
- \approx 4.4 kg

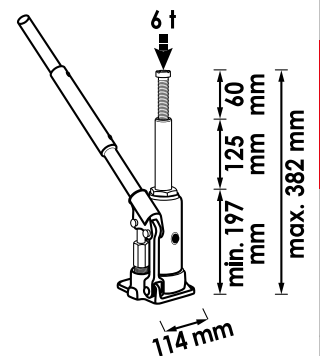
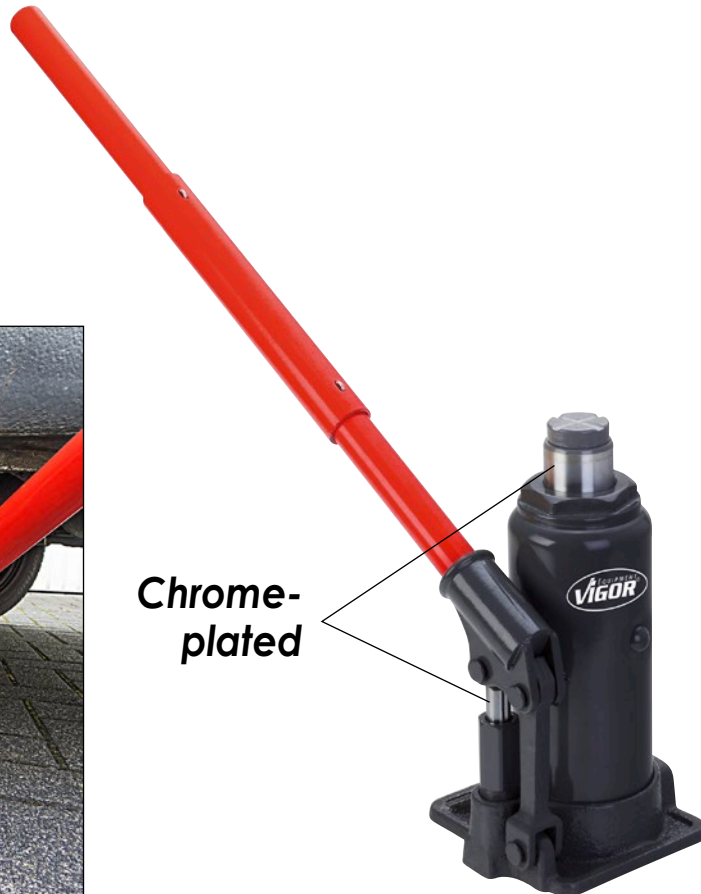

V2477, EAN 4047728024778

Jack stand set 3 tonnes

- 5.2 kg per pair
- Loading capacity: 3 tonnes
- Height 315–460 mm
- Depth: 230 mm

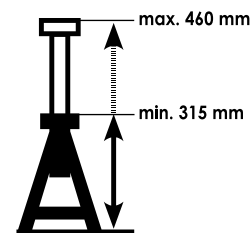

VIGOR No.	Designation	EAN
V2762	Rubber pad	027625



V2648, EAN 4047728026482

Jack stand set 6 tonnes

- 11 kg per pair
- Loading capacity: 6 tonnes
- Height 370–575 mm
- Depth: 300 mm

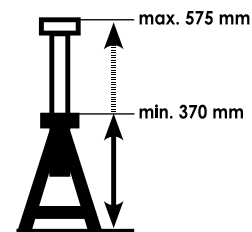
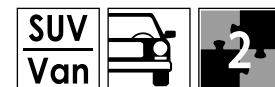

VIGOR No.	Designation	EAN
V2762	Rubber pad	027625



V3564, EAN 4047728**035644**

Tyre lever

- For passenger cars and vans
- Double-T profile ensures high stability
- Length: 500 mm

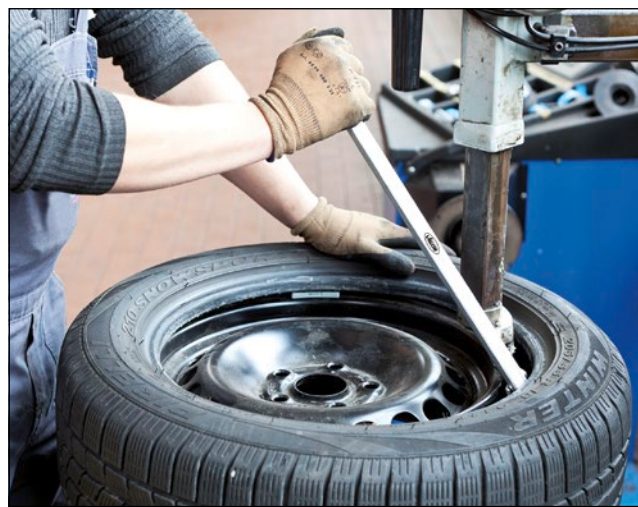

Chrome-plated

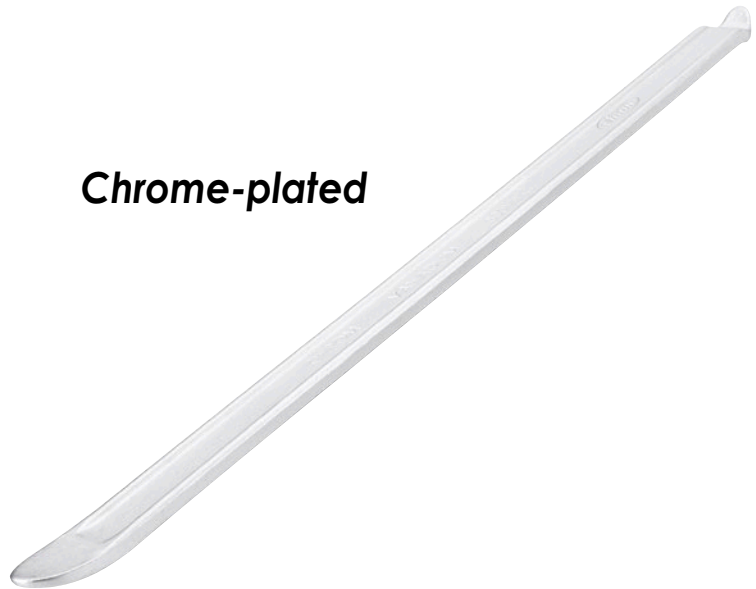

V3563, EAN 4047728**035637**

Tyre lever with plastic coating

- Installing and removing tyres on steel and especially on aluminium rims
- Length: 500 mm



Chrome-plated

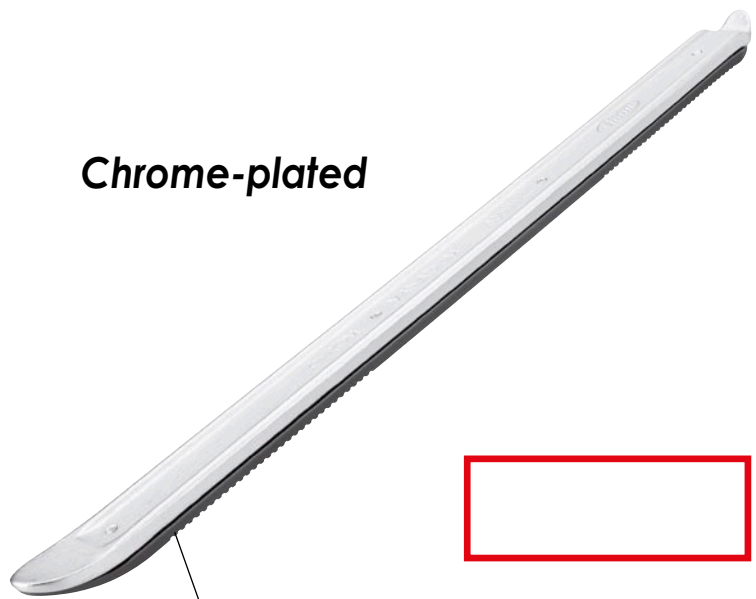

With replaceable plastic coating fixed with screws, including screws



VIGOR No.	Designation	EAN
V3615	Plastic coating with screws	4047728+ 036153



V2512, EAN 4047728025126

Balance weight remover set

- Removing balance weights from light-alloy rims on motorcycles and passenger cars
- Solvent resistant
- Blunt edges may be sharpened with a file
- Also suitable for removing labels and stickers
- No damage to surfaces



VIGOR No.	Length mm	Blade width mm	EAN 4047728+
V2513	500	19	025133
V2514	500	22	025140
V2515	500	25	025157
V2516	500	38	025164



V1657, EAN 4047728016575

Balance weight pliers

- Fastening, loosening and cutting balance weights

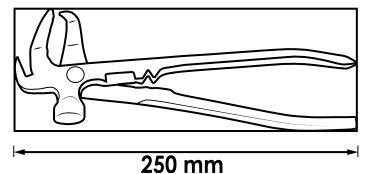

V1584, EAN 4047728015844

Tyre tread depth gauge

- Detecting wear patterns on tyres, brake blocks and brake pads
- Zero-setting in any position
- 3 V (CR 2032)–240 mAh



Large LCD display

Can be switched between mm/inches



V1423, EAN 4047728014236

Tyre pressure gauge

- Quick tyre pressure check
- Small and handy
- Digital display
- Measuring ranges:
0.15–7 bar
2–99.5 PSI
15–70 KPA
- 3 V (CR 2032) – 240 mAh



Automatic shut-off after 90 sec.

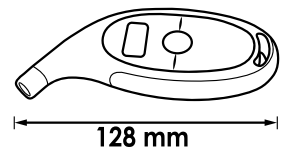

V2235, EAN 4047728022354

2.5 kg rubber hammer

- Loosening rusted rims during a tyre change



Non-rebound due to steel-ball filling



Plastic handle

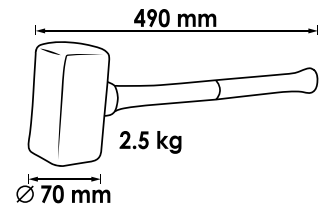

V2234, EAN 4047728022347

5 kg rubber hammer

- Loosening rusted rims during a tyre change
- Extra-heavy design for commercial, agricultural and industrial vehicles



Non-rebound due to steel-ball filling

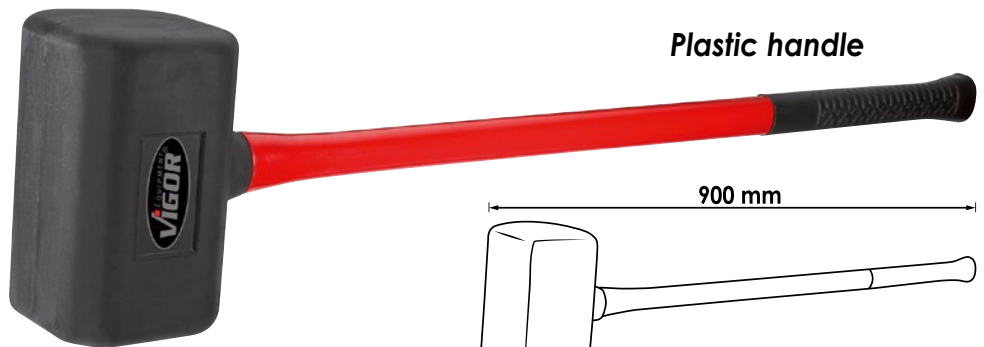

Plastic handle

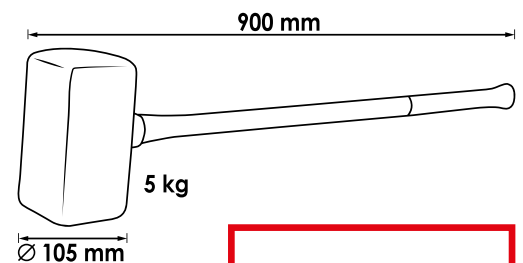

V1571, EAN 4047728015714

Steering wheel level

- Alignment of the steering wheel during axle alignments and work around the steering column
- Quick installation
- Simple adjustment to the steering wheel
- Easy to read
- Universal use for passenger cars, vans and trucks
- Use of the steering wheel level prevents incorrect steering wheel positions
- An exact axle alignment should always be carried out using a calibrated alignment device

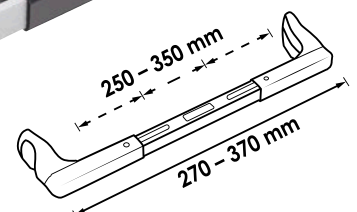



- 
- 
- 
- 
- 
- 
- 
- 
- 
- 
- 
- 
- 



Car body

Wiper arm puller set	331
Window pane holder	332
Repair and installation sets	333
Induction heater and accessories	334–335

Wiper arm puller set



V2523, EAN 4047728**025232**

Wiper arm puller set

- Universally usable
- Allows easy removal of all common wiper arms
- Optimum usability options with rusted and stuck wiper arms
- Best possible protection for integrated wiper nozzles when used with a sliding hammer



①



②



③

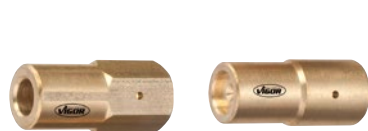

④



⑤



⑥



⑦



⑧



⑨



⑩



⑪



⑫



⑬



	VIGOR No.	Designation	EAN 4047728+
①	V4153	Universal puller	041539
②	V4154	Sliding hammer	041546
③	V4155	Pressure spindle	041553
④	V4156	Spindle extension	041560
⑤	V4157	Spindle attachment	041577
⑥	V4159	Gripper 1	041591
⑦	V4160	Gripper 2	041607
⑧	V4161	Gripper 3	041614
⑨	V4162	Gripper 4	041621
⑩	V4163	Gripper 5	041638
⑪	V4164	Gripper 6	041645
⑫	V4165	Gripper 7	041652
⑬	V4158	Gripper 8	041584

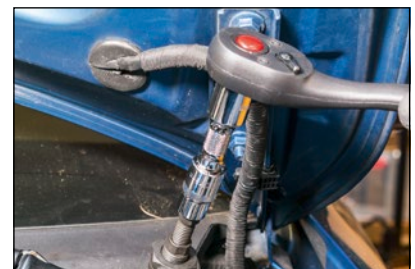

V5531, EAN 4047728055314

Single-hand mini window pane holder

- For lifting, carrying and holding
- Adjusting and setting mirror glass
- One-hand operation using lever
- Loading capacity maximum: 8 kg



With release button



V2685, EAN 4047728026857

Window pane holder

- Loading capacity maximum: 30 kg



With mechanical suction heads



V4193, EAN 4047728041935

Set of pressure pads

- Damage-free opening of vehicle doors
- For positioning, fixing and pushing away car body parts, inner linings, etc.
- Levelling tool for installing window and door frames
- Loading capacity maximum 100 kg

Drain valve
Extremely high
pressure force

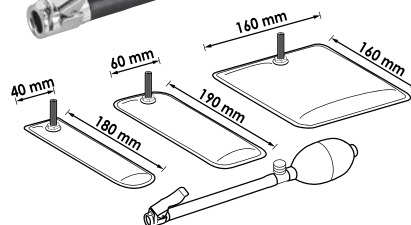

V3551, EAN 4047728**035514**

Repair set for plastic parts

- Repair and reinforcement of plastic parts, such as cracked light bars and housing parts
- Electrical output: 100–240 V–50 / 60 Hz
Maximum up to 20 W
- Contents:
 - 100 staples type V / Ø 0.6 mm
 - 100 staples type W / Ø 0.6 mm
 - 100 staples type W / Ø 0.8 mm

Contents:



Also available:

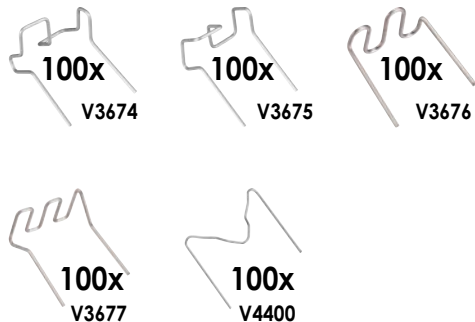

Suitable for repairing components within a few minutes, the kit ensures dimensional stability and prepares the workpiece for subsequent treatments such as painting or filling.

VIGOR No.	Designation	X	EAN 4047728+
V3671	Staples, V-shape 0.6 mm	100	036719
V3672	Staples, W-shape 0.8 mm	100	036726
V3673	Staples, W-shape 0.6 mm	100	036733
V3674	Staples, F-shape 0.8 mm	100	036740
V3675	Staples, S-shape 0.8 mm	100	036757
V3676	Staples, U-shape 0.6 mm	100	036764
V3677	Staples, U-shape 0.8 mm	100	036771
V4400	Staples, M-shape 0.6 mm	100	044004

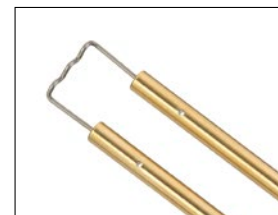
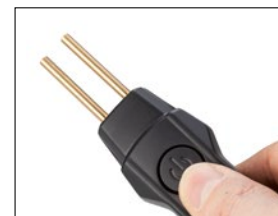

V4891, EAN 4047728**048910**

Induction heater

- Quick, simple removal of parts on vehicles by heating
- Extremely versatile in the car body and commercial vehicle sector due to extensive standard accessories
- Accurately positioned heating within a few seconds due to cutting-edge microprocessor technology
- Easy to transport thanks to plastic case
- Prevention of overheating with a simultaneously high degree of efficiency due to two fans
- Connection cable: 700 mm
- Controlled fan cooling
- Tube coils: heating pipes, bolts, profiles of various diameters
- Flexible coil: for loosening parts that are difficult to access due to the use of a special winding wire
- Flat coil for heating the car body and sheet metal, makes it easier to remove stickers, sealants etc.
- Robust IGBT transistor technology
- Short circuit and idling test
- Automatic adaptation to resonance frequency
- Frequency: 25 kHz – 60 kHz
- 1.5 kW output

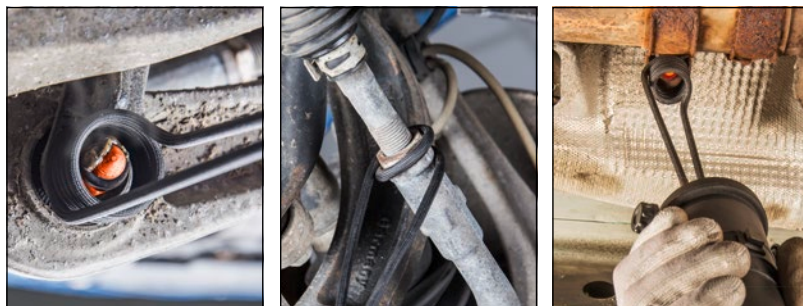
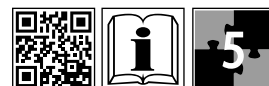

Accurately positioned heating within a few seconds due to cutting-edge microprocessor technology



+
Including 4 coils



V4891-1, EAN 4047728**049573**

Tube coil

- Total length: 222 mm
- Vertical alignment
- Inside diameter 19 mm, up to maximum M 8



V4891-2, EAN 4047728**049580**

Flexible coil

- Total length: 750 mm
- Flexible use on individual motor vehicle components
- For hard-to-reach places

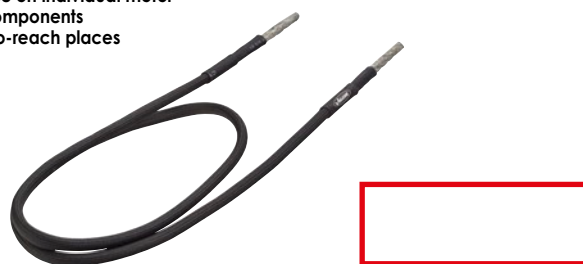

V4891-3, EAN 4047728**049597**

Tube coil

- Total length: 225 mm
- Vertical alignment
- Inside diameter 26 mm, up to maximum M 12



V4891-4, EAN 4047728**049603**

Flat coil

- Optimal for heating surfaces
- Heating of flat screws
- Total length: 227 mm
- Inside diameter: 24 mm, outside diameter: 45 mm

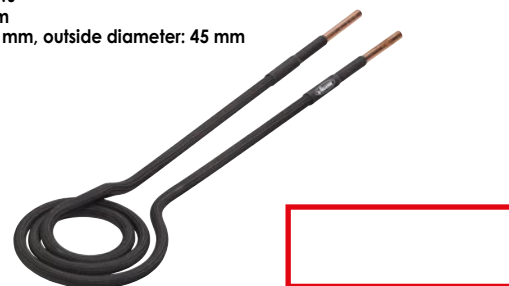

V4891/6, EAN 4047728062206

Induction coil extension set

- Set consisting of:
 - V4891-5 (Focus coil for punctual heating)
 - V4891-6 (Tube coil)
 - V4891-7 (Tube coil)
 - V4891-8 (Flexible coil, ceramic protection)
 - V4891-9 (Tube coil)
 - V4891-10 (Tube coil, lateral)



V4891-5, EAN 4047728062152

Focus coil, for punctual heating

- For heating components which can not be reached with standard coils
- Coil for heating with pinpoint accuracy, to concentrate the energy
- During heating, a distance of approx. 2–4 mm from the workpiece must be maintained to prevent damage to the coil
- Total length: 210 mm



V4891-6, EAN 4047728062169

Tube coil

- Total length: 220 mm
- Vertical alignment
- Inside diameter 15 mm, up to maximum M 6



V4891-7, EAN 4047728062176

Tube coil

- Total length: 240 mm
- Horizontal alignment
- Inside diameter 45 mm, up to maximum M 22



V4891-8, EAN 4047728062183

Flexible coil, ceramic protection

- Total length: 800 mm
- Higher temperature resistance
- The ceramic coating extends the service life
- Self-adjusting distance for smaller components



V4891-9, EAN 4047728062190

Tube coil

- Total length: 220 mm
- Vertical alignment
- Inside diameter 45 mm, up to maximum M 22



V4891-10, EAN 4047728062343

Tube coil, lateral

- Total length: 230 mm
- Horizontal alignment
- Inside diameter 23 mm, up to maximum M 10



V2683, EAN 4047728026833

Steering tie rod joint tool

- Fast, professional replacement of axial joints on steering tie rods on passenger cars and small commercial vehicles
- For steering tie rod ends 35–45 mm Ø



**Roller made of metal
Size 27 mm**

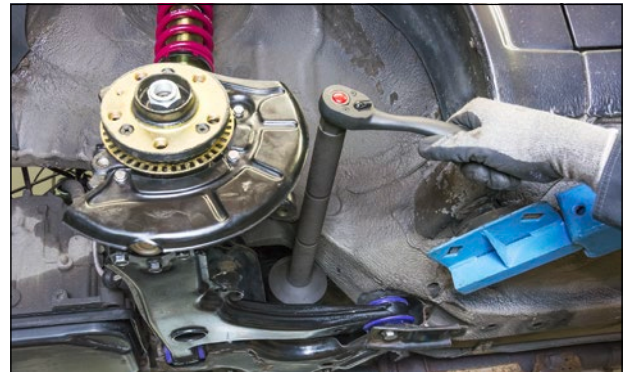
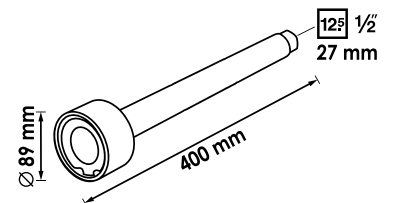

V2684, EAN 4047728026840

Steering tie rod joint tool

- Fast, professional replacement of axial joints on steering tie rods on passenger cars and small commercial vehicles
- For steering tie rod ends 28–35 mm Ø



**Roller made of metal
Size 27 mm**

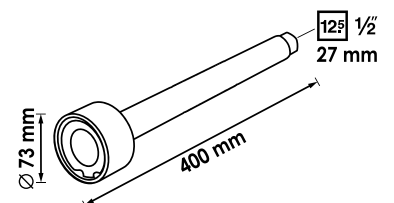

V3863, EAN 4047728038638

Shock absorber assembly tool set

- Installation / removal on shock absorbers with rebound spring
- Clamping piece with V-formed plastic inserts enables fixation in final stop position without causing any damage
- For: BMW · FIAT · FORD · MERCEDES-BENZ · NISSAN · PEUGEOT · TOYOTA
- Contents:
 - Special base component
 - Sturdy threaded spindle M 12 with special receptacle
 - Universal clamping piece with V-formed plastic inserts

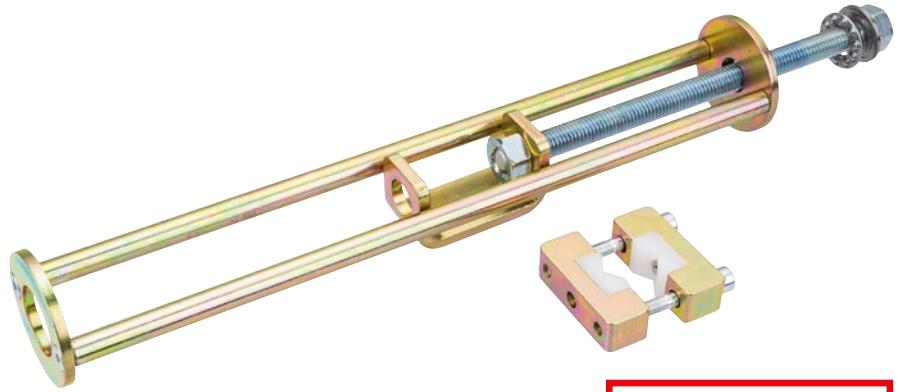

V3661, EAN 4047728036610
Clamping piece with plastic protective jaws (universal)



V4126, EAN 4047728041263

Clamping screw removal tool set for four-link axle VAG

- Loosening the clamping screw on the four-link axle
- For VAG vehicles, e.g. AUDI A4 · A6 etc.
- Can also be used in aluminium axle knuckles
- Contents:
 - 3 high-performance drills (HSS cobalt), size: 6 · 8.5 · 10 mm
 - 1 pressure clamp
 - 1 ejector drift



Drilling with max. 600 rpm



VIGOR No.	Designation	EAN 4047728+
V4248	HSS drill 6 mm	042482
V4249	HSS drill 8.5 mm	042499
V4250	HSS drill 10 mm	042505



V4636, EAN 4047728**046367**

Inner bearing extractor

- Universal application for all vehicle types
- For inner bearing rings in clamping range 40–60 mm
- Due to adapted construction style also for models with ABS housing e.g. VW Golf 4
- Conically shaped tightening screw ensures an even distribution of the clamping force
- For inner bearing rings that rest against the wheel hub

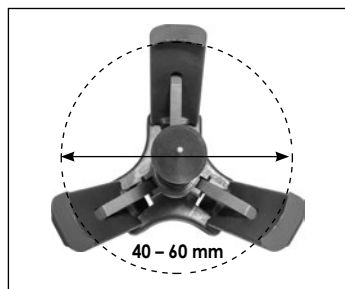

Size 22 mm

Size 36 mm



V6452, EAN 4047728064521

Shock absorber tool set

- Professional repair work on spring struts (counterholding the piston rod when removing and installing)
- Operation of shock absorbing nuts on strut bearings
- For the most common vehicle types
- Contents:
 - Open reversible ratchet, size 21 mm, 12-point
 - Open 6-point sockets:
 - 12.5 = 1/2", size 16 · 17 · 18 · 19 · 21 · 22 · 24 mm
 - 12.5 = 1/2" screwdriver socket, size 6 · 7 · 8 mm
 - 12.5 = 1/2" extension: 250 mm
 - 12.5 = 1/2" sockets, oval 5x8 mm, 6x8 mm



14

NEW



V6956, EAN 4047728069564

Universal axle lever

- Proper, careful installation and removal of axle components such as ball joints and wishbones for example
- Chain adjustment enables flexible use and adaptation to different dimensions and circumstances
- High quality spindle ensures easy working and a high transmission of force
- Direct use on the vehicle without requiring a second person
- Rubber-insulated supporting surface ensures secure hold on the vehicle
- To be used with reversible ratchet or air ratchet



NEW

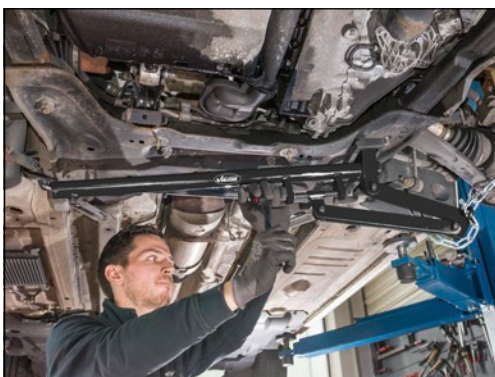
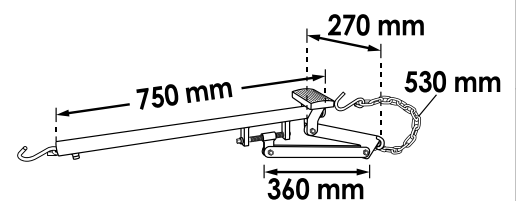

V4642, EAN 4047728046428

Cardan shaft puller, universal

- Proper disassembly of the homokinetic joint and the rubber boots of the drive shaft
- Extra-wide frame, also for large hinges

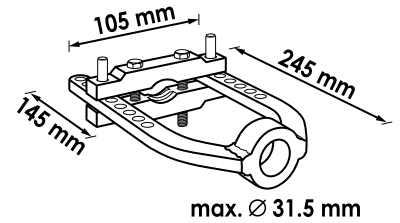

Specially shaped clamping jaws ensure a secure grip on the drive shaft



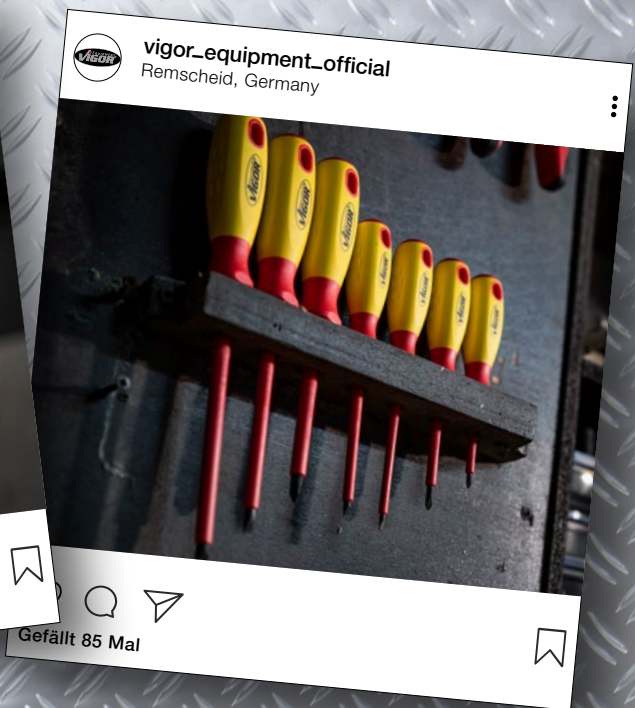

Follow us on

Instagram



For the latest news on our products, "behind the scenes", trade fairs and competitions.

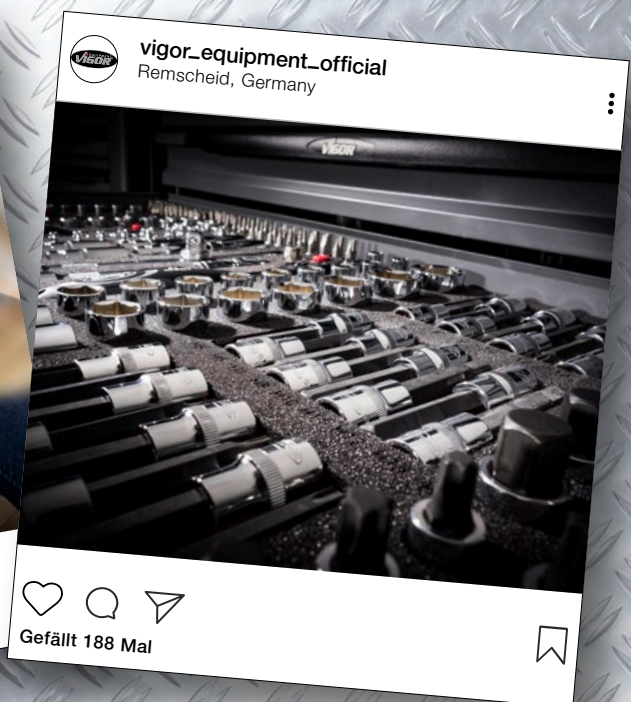



Motor / Commercial Vehicle Chassis Speciality Tools

Tractive and compressive cylinders	344–346
Cylinder accessories	347–350
Mechanical drive	351–352 376–378
Hydraulic pumps	353
Standard wheel bearing tool sets	354–356
Compact wheel bearing tool sets	357
Screwed compact wheel bearing tool sets	358–364
Wheel hub tool sets with 6 and 8 bolts	365
Drive shaft tool sets	366
Multiboxes	367–375
Bearing and bushing tool sets	379–392
Safety spring vice	393–395
Mobile work benches with specialty tool assortment	396–399
Special soft foam inserts	400–403
Commercial vehicle tool sets	404–415



V2873, EAN 4047728028738

Tractive and compressive hydraulic cylinder 8.5 tonnes

- For operation in areas with restricted access
- Adjustable thrust rod
- \approx 1.8 kg

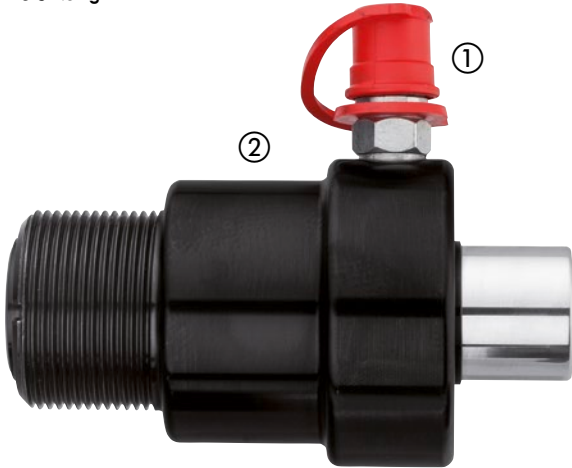

Automatic piston return

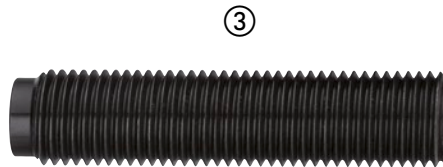

	VIGOR No.	Designation	mm	X	EAN 4047728+
①	V3012	(CEJN) fitting, hydraulic	-	1	030120
②	V3009	Hydraulic cylinder 8.5 tonnes	-	1	030090
③	V3011	Adjustable thrust rod M22	100	1	030113
④	V3010	Impact body with sealing ring	-	1	030106

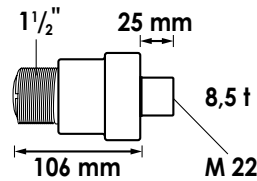

V2869, EAN 4047728028691

Hydraulic cylinder 14 tonnes

- Especially for use in conjunction with the press frames V2885 and V2858
- \approx 2.5 kg

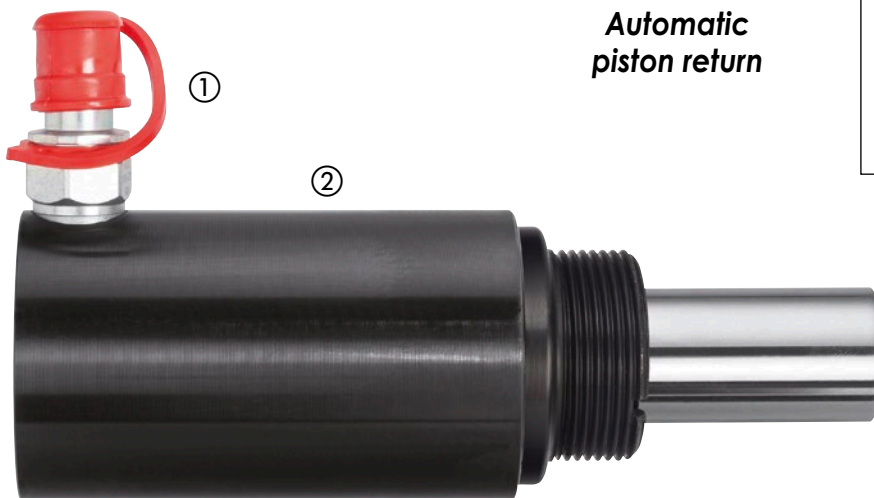

Automatic piston return

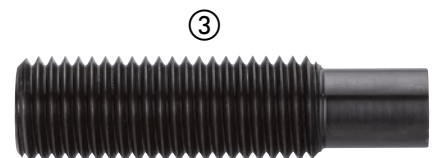
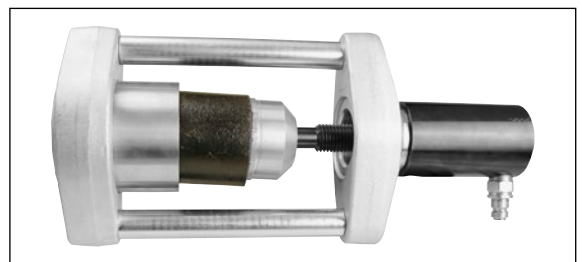

	VIGOR No.	Designation	mm	X	EAN 4047728+
①	V3128	(CEJN) fitting hydraulic	-	1	031288
②	V3217	Hydraulic cylinder 14 tonnes	-	1	032179
③	V3124	Adjustable thrust rod M24	92	1	031240

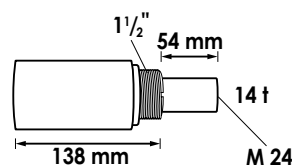

V4551, EAN 4047728**045513**

Tractive and compressive hydraulic cylinder 18 tonnes

- Automatic piston return
- To be used with all tools for passenger cars and drawbars M 10 – M 22 with an appropriate reducer
- Pressure of the hydraulic cylinder may be combined with impact force when using an impact body
- Application: e.g. for removing rusted drive shafts
- \approx 2.8 kg



**Extra light:
only 2.8 kg**

	VIGOR No.	Designation	mm	X	EAN 4047728+
①	V3128	(CEJN) fitting hydraulic	-	1	031288
②	V4552	Hydraulic cylinder 18 tonnes without accessories	-	1	045520
③	V3125	Protection ring for thread 1 1/2"	-	1	031257
④	V3127	Drawbar M18 / M22	250	1	031271
⑤	V3123	Pressure foot M24 x 3 mm	-	1	031233
⑥	V4568	Adjustable thrust rod 92 mm, M24	92	1	045681
⑦	V4553	Pressure shaft	-	1	045537
⑧	V3126	Flange nut M18	-	1	031264
⑨	V3018	Impact body M22x2.5 mm	-	1	030182
⑩	V3129	Adjustable pressure piece M24	132	1	031295

Automatic piston return

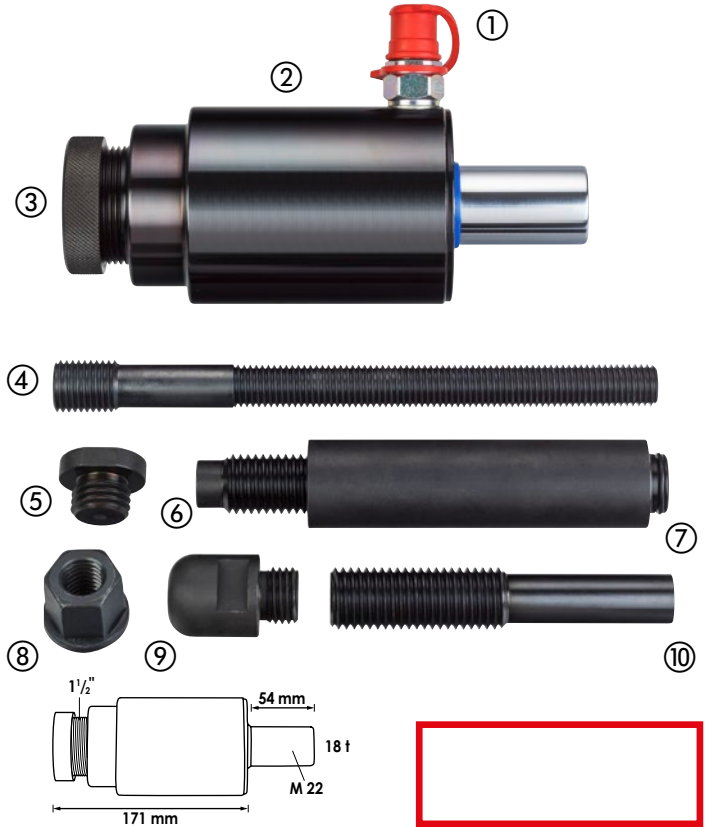

V2854, EAN 4047728**028547**

Tractive and compressive hydraulic cylinder 22 tonnes

- To be used with all tools for passenger cars and drawbars M 10 – M 22 with an appropriate reducer
- Pressure of the hydraulic cylinder may be combined with impact force when using an impact body
- Application: e.g. for removing rusted drive shafts
- \approx 4.7 kg



	VIGOR No.	Designation	mm	X	EAN 4047728+
①	V3128	(CEJN) fitting hydraulic	-	1	031288
②	V3199	Hydraulic cylinder 22 tonnes	-	1	031998
③	V3125	Protection ring for thread 1 1/2"	-	1	031257
④	V3127	Drawbar M18 / M22	250	1	031271
⑤	V3126	Flange nut M18	-	1	031264
⑥	V3124	Adjustable thrust rod M24	92	1	031240
⑦	V3134	Pressure shaft M24 x 3 mm	151	1	031349
⑧	V3123	Pressure foot M24 x 3 mm	-	1	031233
⑨	V3018	Impact body M22x2.5 mm	-	1	030182
⑩	V3130	Adjustable pressure piece M24	109	1	031301

Automatic piston return

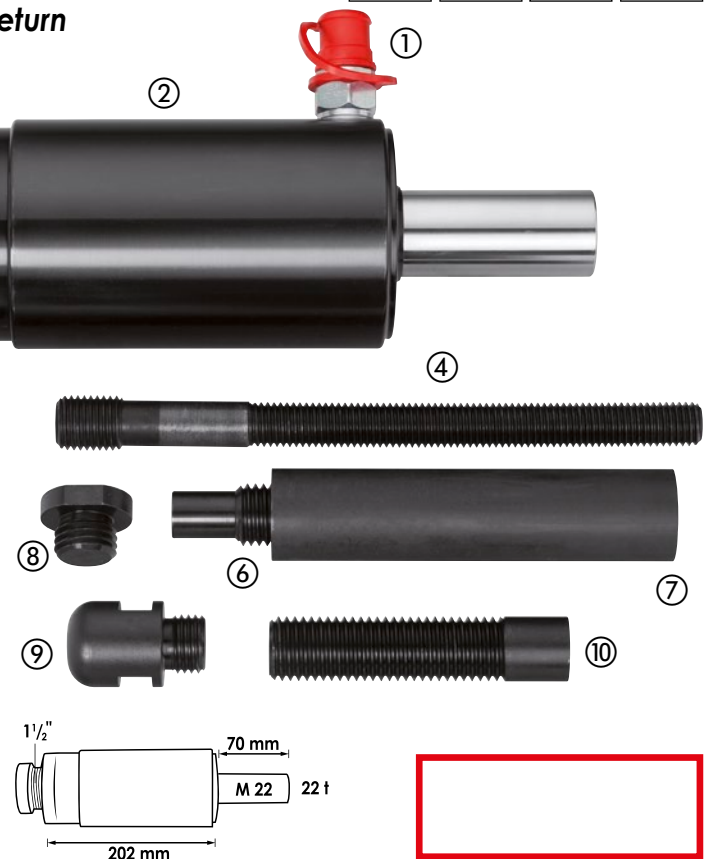

V2874, EAN 4047728**028745**

Tractive and compressive hydraulic cylinder 32 tonnes

- For use in workshops, also suitable for vans
- Pressure of the hydraulic cylinder may be combined with impact force when using an impact body
- With the correct adapter, drawbars of M 10 to M 22 can be used
- \approx 8.3 kg



Automatic piston return

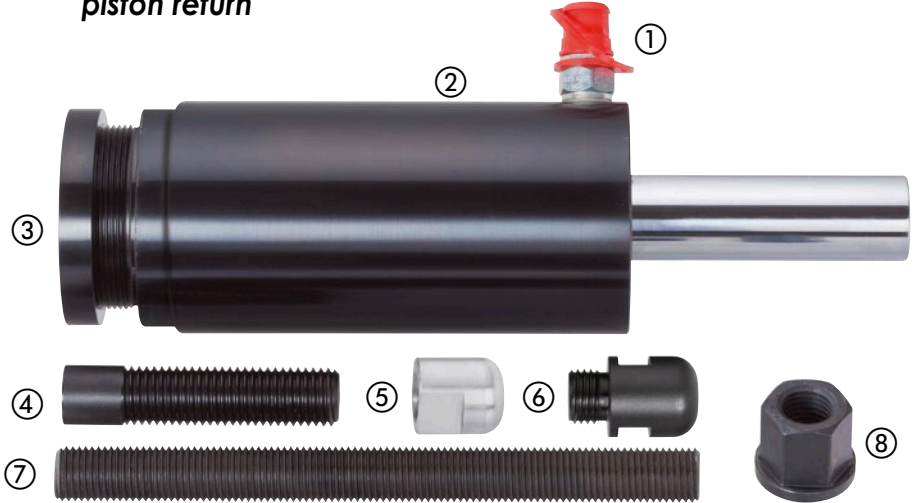

	VIGOR No.	Designation	mm		EAN 4047728+
①	V3128	(CEJN) fitting hydraulic	-	1	031288
②	V3216	Hydraulic cylinder 32 tonnes	-	1	032162
③	V3131	Protection ring for thread 2.5	-	1	031318
④	V3130	Adjustable pressure piece M24	109	1	031301
⑤	V3092	Striker nut M22	-	1	030922
⑥	V3018	Impact body M22x2.5 mm	-	1	030182
⑦	V3133	Drawbar M22	250	1	031332
⑧	V3132	Flange nut M22	-	1	031325

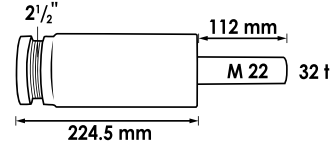

V4229, EAN 4047728**042291**

Tractive and compressive hydraulic cylinder 45 tonnes

- For use in commercial vehicle workshops
- Pressure of the hydraulic cylinder may be combined with impact force when using an impact body
- Automatic piston return
- \approx 11.3 kg



Automatic piston return

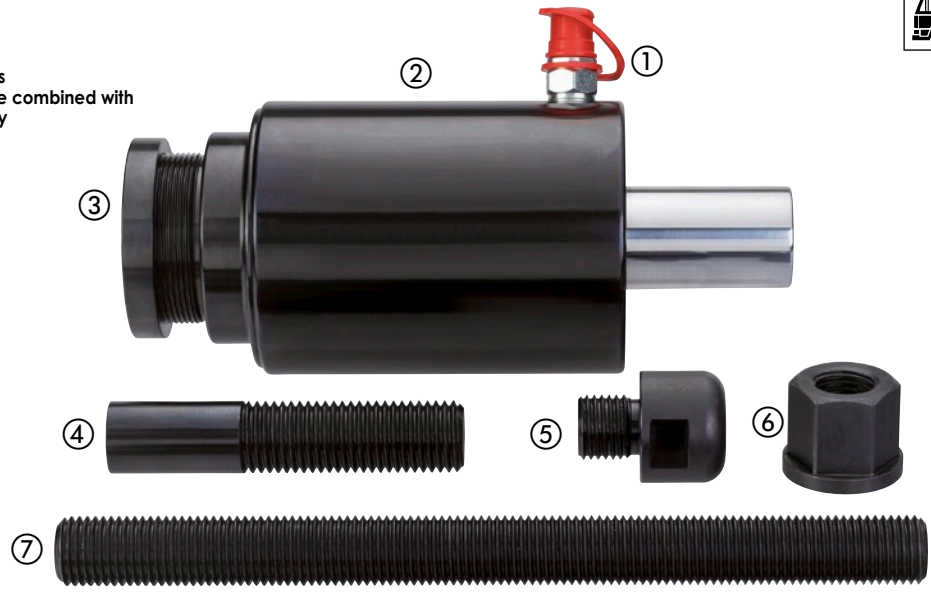

	VIGOR No.	Designation	mm		EAN 4047728+
①	V3128	(CEJN) fitting hydraulic	-	1	031288
②	V4242	Hydraulic cylinder 45 tons	-	1	042420
③	V3131	Protection ring for thread 2.5	-	1	031318
④	V4251	Adjustable pressure piece M30	145	1	042512
⑤	V4254	Impact body M27	-	1	042543
⑥	V4252	Flange nut M27	-	1	042529
⑦	V4253	Drawbar M27	330	1	042536

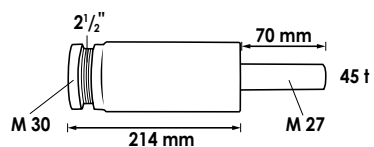

V4218, EAN 4047728042185

Support set for hydraulic cylinders

- Use as hand-held bit holders or with transmission jacks
- For all standard transmission jacks with \varnothing of 25 and 30 mm
- For hydraulic cylinder V2869 (14 tonnes) · V2855 (16 tonnes) · V4551 (18 tonnes) · V2854 (22 tonnes) · V2874 (32 tonnes)
- Also for hydraulic cylinders with 65–100 mm \varnothing (e.g. Paschke Profitec, Klann)
- Trouble-free adjustment and fixation of the hydraulic cylinder enables flexible and fast handling when working directly on the vehicle



	VIGOR No.	Designation		EAN 4047728+
①	V4244	Clamp \varnothing 70 mm	1	042444
②	V4245	Clamp \varnothing 85 mm	1	042451
③	V4246	Clamp \varnothing 100 mm	1	042468
④	V4243	Bracket without clamp for V4218	1	042437



V3207, EAN 4047728032070

Set of drawbars, flange nuts and adapters

	VIGOR No.	Designation	mm		EAN 4047728+
①	V3210	Drawbar M10	150	1	032100
②	V3220	Drawbar M12	250	1	032209
③	V3136	Drawbar M14	250	1	031363
④	V3127	Drawbar M18 / M22	250	1	031271
⑤	V3133	Drawbar M22	250	1	031332
⑥	V3209	Adapter M22–M10	–	1	032094
⑦	V3219	Adapter M22–M12	–	1	032193
⑧	V3135	Adapter M22–M14	–	1	031356
⑨	V3275	Flange nut M10	–	1	032759
⑩	V3208	Flange nut M12	–	1	032087
⑪	V3137	Flange nut M14	–	2	031370
⑫	V3126	Flange nut M18	–	1	031264
⑬	V3132	Flange nut M22	–	1	031325

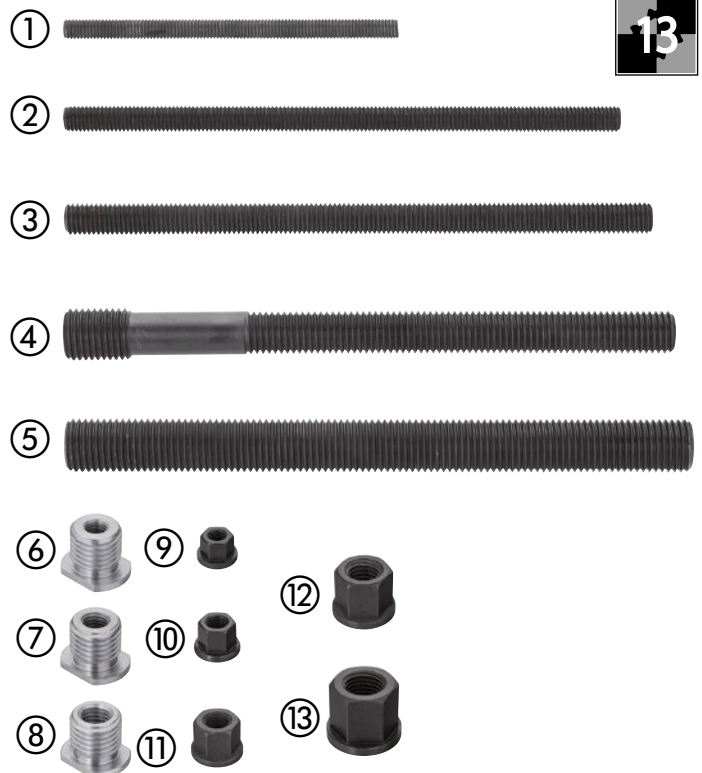

	VIGOR No.	Designation	EAN 4047728+
⑭	V4596	Adapter M18–M22	045964
⑮	V4597	Adapter M27–M22	045971
⑯	V4342	Striker nut M18	043427

* Not included in set



V2850, EAN 4047728028509

Adapter

- Adaptation of Klann hydraulic cylinder 17 tonnes to VIGOR specialty tools
- Adapter 2 1/4" - 14 UNS (Klann thread) on 1 1/2"

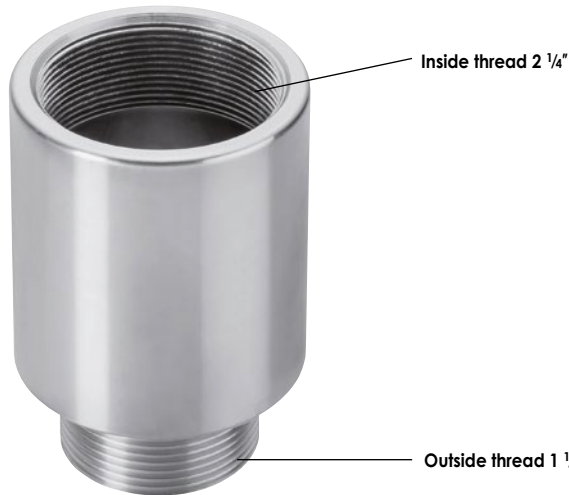

V2851, EAN 4047728028516

Adapter

- Adaptation of VIGOR hydraulic cylinder (8.5 tonnes to 22 tonnes) to KLANN specialty tools
- Adapter 2 1/4" - 14 UNS (Klann thread) on 1 1/2"

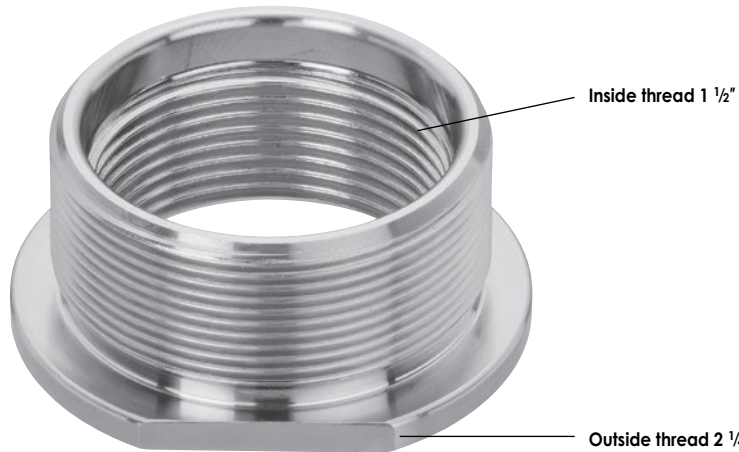

V2910, EAN 4047728029100

Adapter

- Adaptation of hydraulic cylinders 16 tonnes (V2855) and 22 tonnes (V2854) to the VIGOR specialty tool with 1 1/2" thread
- Adapter 1 1/2" to 2 1/2" - 11 UN

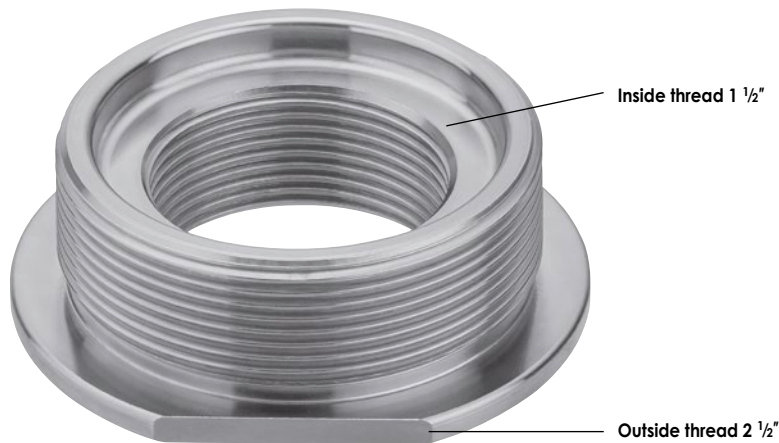

V3869, EAN 4047728**038690**

Adapter

- Adaptation of VIGOR hydraulic cylinder to Paschke Profitec specialty tools
- Adapter M 68x2 mm (Paschke Profitec thread) on 1 1/2"

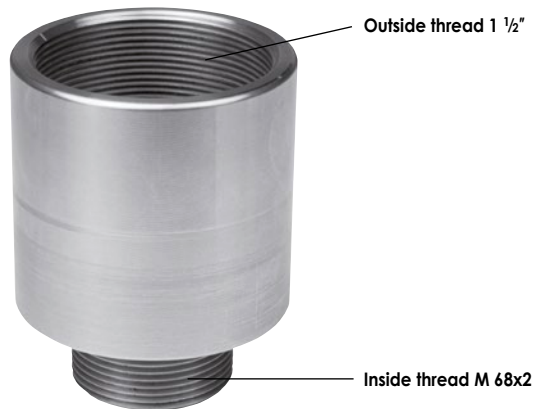

V3870, EAN 4047728**038706**

Adapter

- Adaptation of the Paschke Profitec hydraulic cylinder to the VIGOR specialty tools
- Adapter M 68x2 mm (Paschke Profitec thread) on 1 1/2"-11

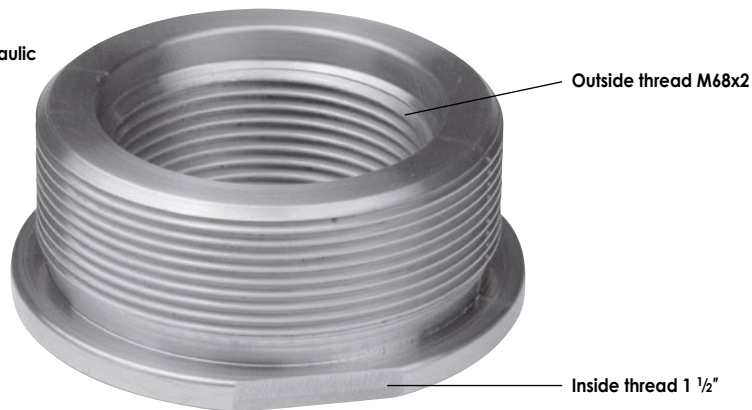

V4220, EAN 4047728**042208**

Adapter

- Adaptation of Klann hydraulic cylinder 28 tonnes to VIGOR specialty tools
- Adapter 2 3/4"-14 UNS (Klann thread) on 2 1/2"

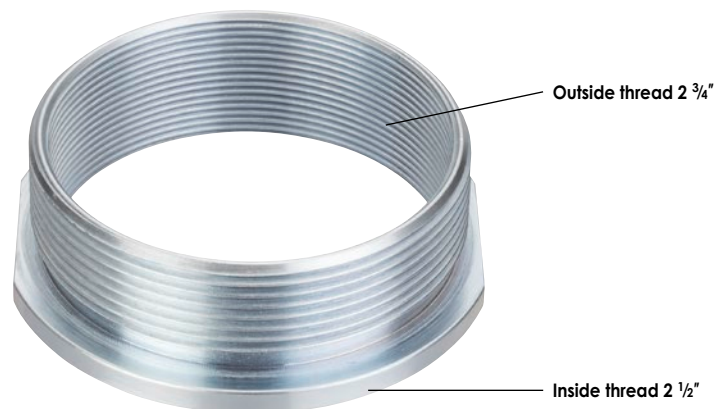

V3582, EAN 4047728**035828**

Protective cover

- Protection while working with hydraulic cylinders together with specialty tools



V3612, EAN 4047728036122

Manometer

- Connecting piece and fitting for direct coupling to all VIGOR hydraulic pumps
- For information concerning the maximum pressure range of the hydraulic cylinders, see the respective operating instructions



V6592, EAN 4047728065924

Adapter 3/8" inside thread, on CEJN / pump

- Adapting e.g. Klann or Sauer hydraulic pumps to the CEJN connection
- Quick, easy connection
- Non-drip, without oil loss
- Protects system against ingress of air
- CEJN connections are smaller than standard connections – for areas with restricted access
- Flexible and easy locking without distortion

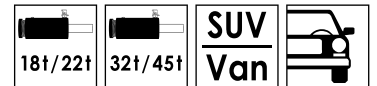

V6591, EAN 4047728065917

Adapter 3/8" outside thread, on CEJN / cylinder

- Adapting e.g. Klann or Sauer hydraulic cylinders to the CEJN connection
- Quick, easy connection
- Non-drip, without oil loss
- Protects system against ingress of air
- CEJN connections are smaller than standard connections – for areas with restricted access
- Flexible and easy locking without distortion

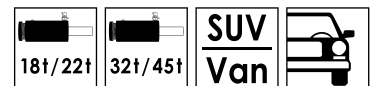

V2853, EAN 4047728028530

Spindle set, mechanical

- Mechanical spindle for tool sets · V2865 · V2845 · V2848 · V2860 · V2870 · V4491 · V4629 · V2860 · V3731 and V3732
- 330 mm length is sufficient for almost all work to be performed

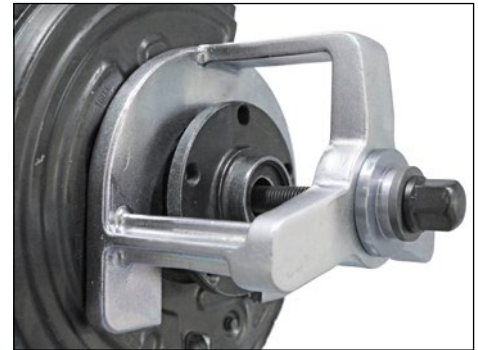
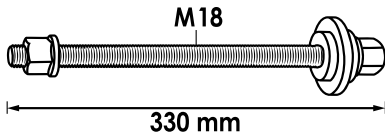

	VIGOR No.	Designation	← L → mm	X	EAN 4047728+
①	V3126	Flange nut M18	-	1	031264
②	V3008	Drawbar with flange nut M18	330	1	030083
③	V3206	Washer	-	1	032063
④	V3205	Thrust washer	-	1	032056



V4699, EAN 4047728046992

Pressure spindle set, manual

- Manual pressure spindle set for mechanical operation of specialty tools
- Included in the set are four thrust rods of varying lengths with which the use of different tools is guaranteed
- Use with V3072 · V2858 · V3147 · V3649 · V3148 · V2885 · V2920 and V2937
- Spindle and adapter are designed especially for pneumatically supported operation, making work with an impact wrench up to a maximum of 1000 Nm tightening torque possible, for example
- Effective transfer of spindle forces is at a maximum of 15 tonnes
- In the case of frequent work with supporting joints, bushes and drive shafts, we recommend using the 8.5–22 tonnes hydraulic cylinder

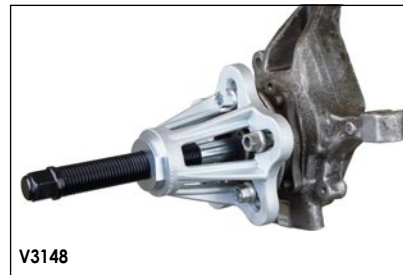
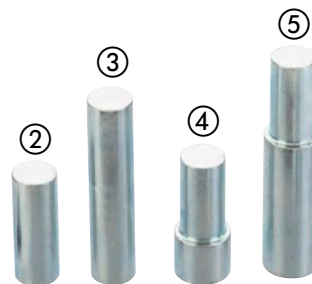

	VIGOR No.	Designation	X	EAN 4047728+
①	V4699-3	Washer Ø 18.8x3 mm (4 pcs)	1	047029
②	V4699-4	Press axle 50xØ 19 mm	1	047036
③	V4699-5	Press axle 85xØ 19 mm	1	047043
④	V4699-6	Press axle 56xØ 24 mm	1	047050
⑤	V4699-7	Press axle 100xØ 24 mm	1	047067
⑥	V4699-1	Pressure spindle M 30 190 mm	1	047005
⑦	V4699-2	Adapter 1 1/2" - M 30	1	047012



V2867, EAN 4047728**028677**

Circlip tool

- Facilitates the removal of frequently rusted circlips located in the inside of wheel bearings
- Maximum force and fast removal due to adjusting screw with recesses for a 6.3 = 1/4" ratchet
- For passenger cars, vans and trucks
- Unique construction always ensures the right angle of the tip regardless of the size of the circlip
- Very simple tip replacement



- 2x Ø 2.5 mm
- 2x Ø 3.0 mm
- 2x Ø 3.5 mm



5 - 95 mm
clamping range



Spare tips for V2867

VIGOR No.	Designation		EAN 4047728+
V2992	Tip Ø 2.5 mm	4	029926
V2993	Tip Ø 3.0 mm	4	029933
V2994	Tip Ø 3.5 mm	4	029940

V2927, EAN 4047728**029278**

Scraper

- Removing rust from the outer edge of the brake discs as well as from the brake calliper lining
- We recommend using crank V2928 to turn the brake disc during the cleaning process



V2928, EAN 4047728**029285**

Crank for brake disc

- Removal of rust from the outer edge
- Turning the brake disc when using scraper V2927



V2846, EAN 4047728**028462**

Hydraulic pump, pneumatic

- For all hydraulic cylinders
- Including oil dipstick

Design including manometer

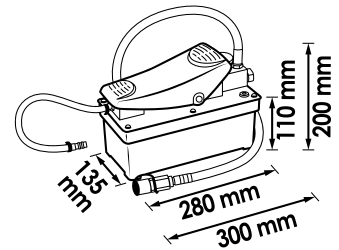
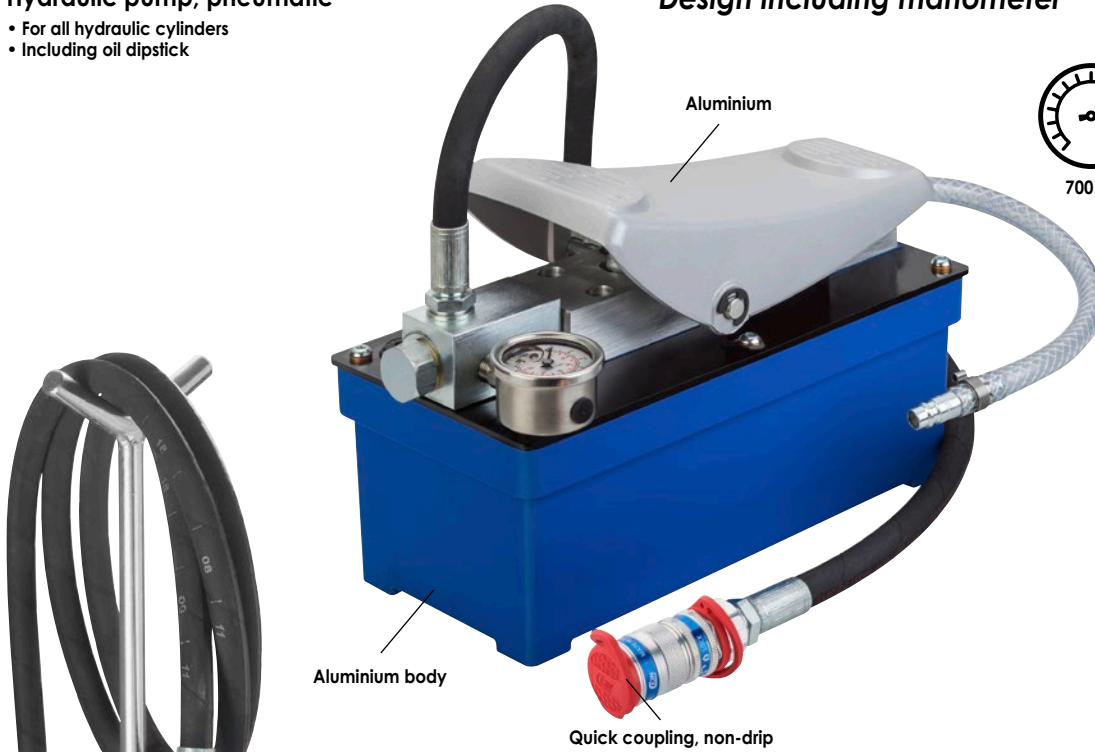

VIGOR No.	Designation		EAN 4047728+
V3120	Hydraulic hose	1	031202
V3141	(CEJN-) quick coupler connection	1	031417
V4255	Manometer	1	042550



V2847, EAN 4047728**028479**

Hydraulic foot pump

- For all hydraulic cylinders

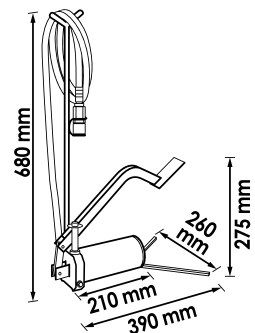
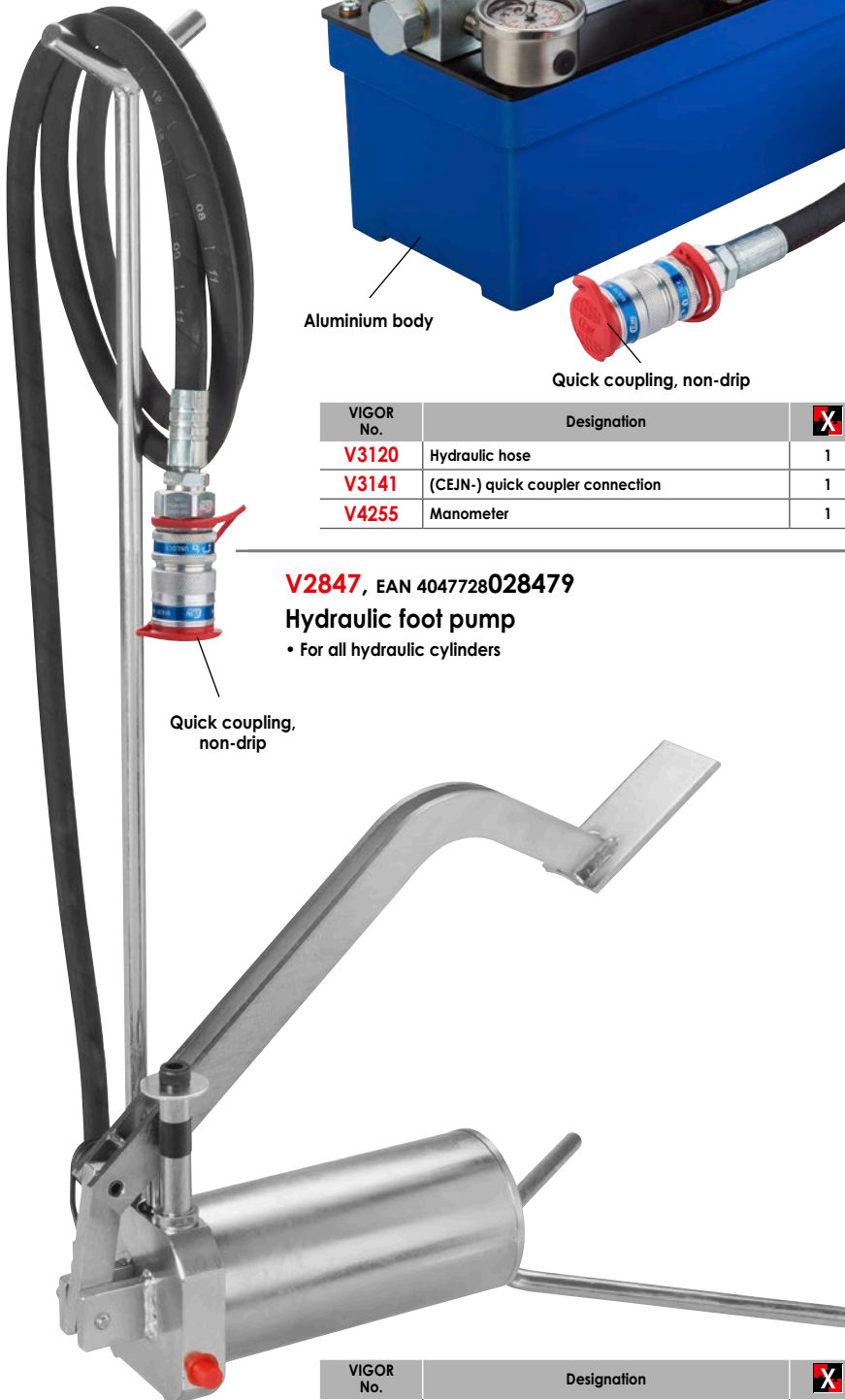

VIGOR No.	Designation		EAN 4047728+
V3120	Hydraulic hose	1	031202
V3614	Gasket set	1	036146
V3141	(CEJN-) quick coupler connection	1	031417



V4629, EAN 4047728046299

Wheel hub removal tool, universal

- Effective method for disassembling wheel hubs.
- Recommendation: Use wheel bearing tool set V4598
- Functions also with steering knuckles with uneven and limited surfaces
- Significant time savings compared to former systems

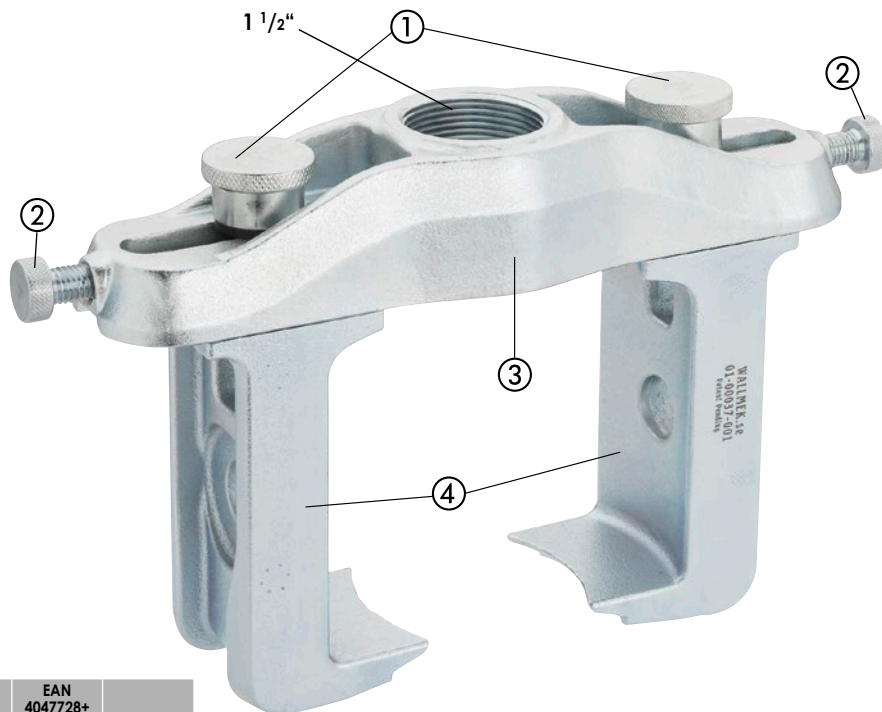
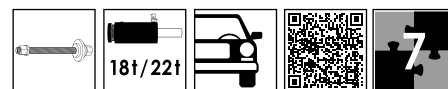

	VIGOR No.	Designation	X	EAN 4047728+
①	V3873	Fixing screw M14	2	038737
②	V3874	Screw M12	2	038744
③	V3871	Crossbar	1	038713
④	V4629-1	Pressure foot set for V4629, 2 pieces	2	046305



V2845, EAN 4047728028455

Hub and bearing shell

- For wheel bearing and hub on e.g.:
 FORD: C-Max
 MAZDA: 3
 Volvo: S40 · V50
 ŠKODA: Octavia 1996 → 2004
 VW: Golf 4 · Bora · Beetle
 AUDI: A3 · S3 · TT 1999 → 2006
 SEAT: León 1 · Toledo 2
- As well as for certain models from CITROËN · PEUGEOT · RENAULT and VAG with separated wheel bearing / hub (Note: Normal press frame is not suitable)
- To be used with V4629



	VIGOR No.	Designation	X	EAN 4047728+
①	V3040	Pressure pipe, large	1	030403
②	V3039	Thrust washer, large	1	030397



V3072, EAN 4047728030724

Press frame

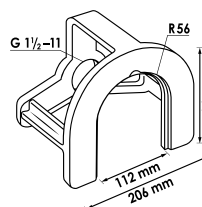

V4598, EAN 4047728**045988**

Wheel bearing / hub tool and drive shaft set, universal

- Allows the wheel bearings to be changed directly on the vehicle with minimum time spent
- Together with hydraulic cylinder or manual spindle
- All parts are adapted for the wheel bearing sizes currently found on the market
- The mounting washers have a guide and are usable on both sides
- Mounting washers with $\varnothing 62-83$ mm and support discs of $34-60$ mm are included, the bearing shell is for wheel bearings of up to $\varnothing 92$ mm
- Removal of the wheel hub with V4629 · V2849 and V3072
- Working time: approx. 20-30 minutes per side
- Wheel alignment and brake bleeding not necessary
- Not necessary to remove the ABS sensor, steering knuckle, strut or steering tie rod

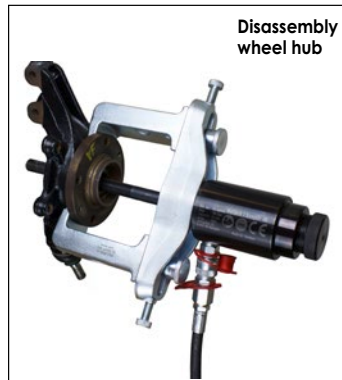

	VIGOR No.	Designation	EAN 4047728+
①	V4598-30	Pressure pipe length 78 mm, inside hole $\varnothing 20.25$ mm, suitable for spindle M 20	046282
②	V4598-22	Bearing shell $\varnothing 82.5$ mm	046275
③	V4598-21	Bearing shell $\varnothing 75.5$ mm	046268
④	V4598-20	Bearing shell $\varnothing 93$ mm	046251
⑤	V4598-10	Bearing washer $\varnothing 61.8-62.8$ mm, inside hole $\varnothing 20.25$ mm, suitable for spindle M 20	046183
⑥	V4598-11	Bearing washer $\varnothing 63.8-64.8$ mm, inside hole $\varnothing 20.25$ mm, suitable for spindle M 20	046190
⑦	V4598-12	Bearing washer $\varnothing 65.8-66.8$ mm, inside hole $\varnothing 20.25$ mm, suitable for spindle M 20	046206
⑧	V4598-13	Bearing washer $\varnothing 68.8-70.8$ mm, inside hole $\varnothing 20.25$ mm, suitable for spindle M 20	046213
⑨	V4598-14	Bearing washer $\varnothing 72.5-74.5$ mm, inside hole $\varnothing 20.25$ mm, suitable for spindle M 20	046220

	VIGOR No.	Designation	EAN 4047728+
⑩	V4598-15	Bearing washer $\varnothing 76.5-78.5$ mm, inside hole $\varnothing 20.25$ mm, suitable for spindle M 20	046237
⑪	V4598-16	Bearing washer $\varnothing 80.8-82.8$ mm, inside hole $\varnothing 20.25$ mm, suitable for spindle M 20	046244
⑫	V3060	Counterholder, inside hole $\varnothing 20.25$ mm, suitable for spindle M 20	030601
⑬	V4614	Support disc, tapered $\varnothing 33.8$ mm, inside hole $\varnothing 20.25$ mm, suitable for spindle M 20	046145
⑭	V4598-2	Support disc, tapered $\varnothing 38.8$ mm, inside hole $\varnothing 20.25$ mm, suitable for spindle M 20	046152
⑮	V4598-3	Support disc, tapered $\varnothing 43.8$ mm, inside hole $\varnothing 20.25$ mm, suitable for spindle M 20	046169
⑯	V4598-4	Support disc, tapered $\varnothing 59.8$ mm, inside hole $\varnothing 20.25$ mm, suitable for spindle M 20	046176



V4599, EAN 4047728045995

Wheel bearing tool set AUDI Q7, VW Touareg, PORSCHE Cayenne

- Wheel bearings change on the front axle
- On AUDI Q7 · VW Touareg · PORSCHE Cayenne
- Changing the wheel bearing on the rear axle on AUDI Q7
- Shape of tool prevents damaging of ABS sensor
- Addition to removal of wheel hub: V4629
- Addition to removal of wheel bearing: V2860
- Reduces the time spent to approx. 30 minutes
- Wheel bearings change directly on the vehicle without time-consuming disassembly

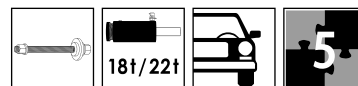

	VIGOR No.	Designation	X	EAN 4047728+
①	V3071	Bearing washer Ø 95 mm, inside hole Ø 20.25 mm, suitable for spindle M 20	1	030717
②	V4598-30	Pressure pipe length 78 mm, inside hole Ø 20.25 mm, suitable for spindle M 20	1	046282
③	V3070	Bearing washer Ø 92 mm	1	030700
④	V4598-12	Bearing washer Ø 65.8–66.8 mm, inside hole Ø 20.25 mm, suitable for spindle M 20	1	046206
⑤	V4598-3	Support disc, tapered Ø 43.8 mm, inside hole Ø 20.25 mm, suitable for spindle M 20	1	046169

V4594, EAN 4047728045940

Adjustable wheel bearing fixation

- Wheel bearings, removed to the inside
- The plate allows optimum adjustment to an inclined or uneven surface on the inside, forming an even pressing surface
- Use with hydraulic cylinder, mechanical spindle or workshop press
- To be used with V4629
- Disassembly of the wheel bearing with V4598
- E.g. on
 - CITROËN: Berlingo (model years 1996 →), Jumpy (model years 1995 →)
 - RENAULT: Clio (model years 1991 → 2012)
 - FIAT: Scudo (model years 1995 →)
 - PEUGEOT: Partner (model years 1996 →), Expert (model years 1995 →)
 - KIA: Rio (2001 → 2005), Ceéd (2006 → 2012)
 - HYUNDAI: i30 (model years 2007 →)

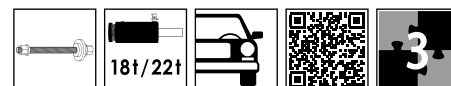

*Universal fixation
for all bearings to
remove backwards*

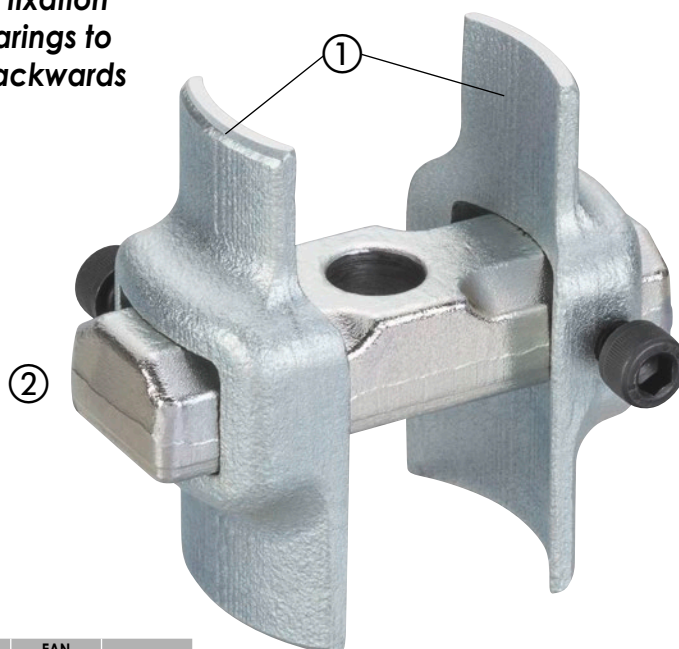

	VIGOR No.	Designation	X	EAN 4047728+
①	V4594-1	Pressure foot set for V4594, 2 pieces	1	045957
②	V3060	Counterholder, inside hole Ø 20.25 mm, suitable for spindle M 20	1	030601

V2860, EAN 4047728028608

Compact wheel bearing removal tool set, universal

• Removing compact wheel bearings with or without circlip

• For e.g.:

- VW: Polo · Lupo · Touareg · Fox · T5 front and rear, Crafter
- AUDI: A2
- SEAT: Ibiza · Córdoba
- ŠKODA: Fabia · Rapid · Roomster
- FORD: Focus · C-Max · Mondeo · S-Max · Kuga
- LAND ROVER: Freelander 2
- MAZDA: 3 · 5 · 6 · CX-7
- MERCEDES-BENZ: Sprinter, Vito, Viano
- MITSUBISHI: Colt
- SMART: Forfour
- Volvo: V50 · S40 · V70 · S80 · XC60
- BMW: 3 F30/F31 (2012 → 2015), 3 E90/E91 SED/TOU (2005 → 2012)
- BMW: 1 F20/F21 (2011 → 2015), 1 E82/E88 Coupé/CAB (2006 → 2015), 1 E87/E81 5D/3D

• Disassembly of the wheel hub on passenger cars
• Can be used in conjunction with mechanical spindle

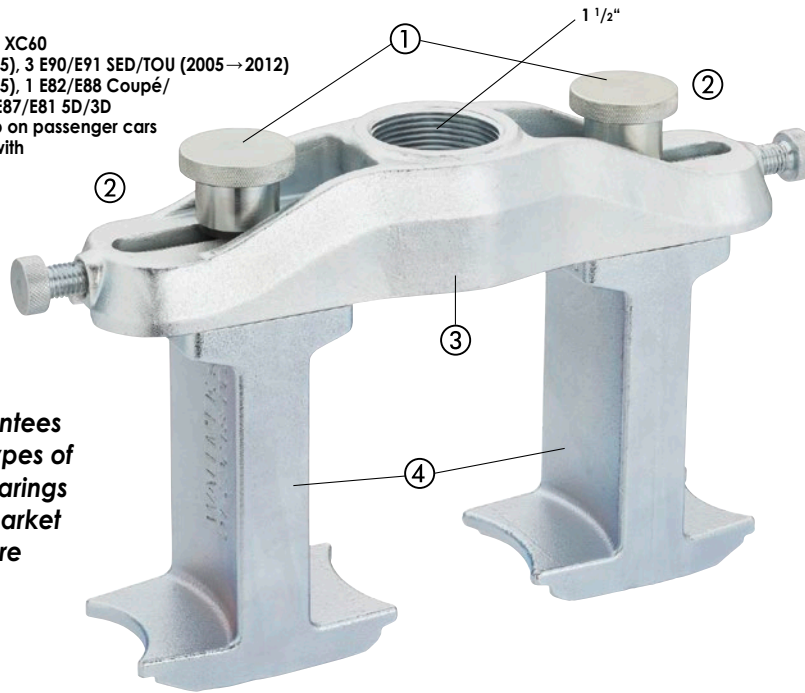

Adjustability guarantees application on all types of compact wheel bearings available on the market now and in future

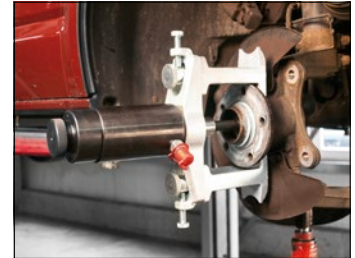

	VIGOR No.	Designation		EAN 4047728+
①	V3873	Fixing screw M14	2	038737
②	V3874	Screw M12	2	038744
③	V3871	Crossbar	1	038713
④	V3755	Pressure foot	2	037556



V2864, EAN 4047728028646

Thrust washer, conical, universal

• Conical washer for the removal of compact wheel bearings



Inside diameter 20.25 mm suitable for M 20 spindle

Suitable for all sizes



V6824, EAN 4047728068246

Half shell set for 92 mm compact wheel bearings

- Changing the wheel bearings directly on the vehicle without removal of the steering knuckle
- Compact wheel bearings become damaged internally due to improper installation and pressure on the wheel hub
- Professional installation is ensured with the help of a special adapter ring
- Removal of the wheel bearing unit also possible together with the tools V2860 · V2864 · V5027
- Installation with tools V4491 and V2862
- Hydraulic or manual drive tools are also required
- For, among others:
 - PEUGEOT Expert · Traveller model years 2016 →
 - CITROËN SpaceTourer model years 2016 →
 - TOYOTA Proace · Proace Verso model years 2016 →



V3731, EAN 4047728037310

Wheel bearing unit, screwed, removal tool set, universal

- Removing screwed wheel bearing units (4 bolts) at the front and rear axle
- Usage of the pressure feet on both sides ensures quick and easy adjustment at the steering knuckle
- Maximum loading capacity: 22 tonnes
- Adjustability guarantees usage with all models of screwed wheel bearing units with 4 bolts currently available on the market
- Can be used directly on the vehicle
- For: VAG · FORD · MAZDA · TOYOTA · MITSUBISHI · AUDI A4 · A6 · VW Passat · SKODA Octavia · SEAT Exeo and many others

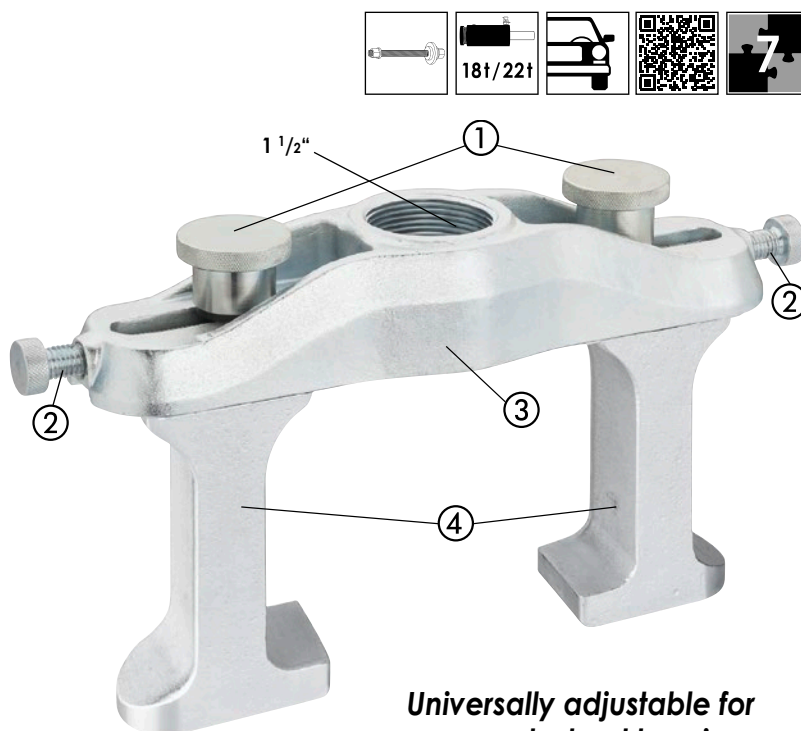
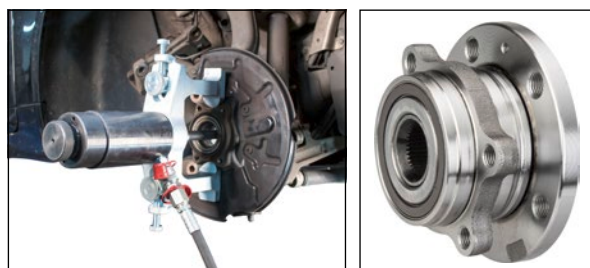

Universally adjustable for screwed wheel bearing units with 4 bolts

	VIGOR No.	Designation	X	EAN 4047728+
①	V3873	Fixing screw M14	2	038737
②	V3874	Screw M12	2	038744
③	V3871	Crossbar	1	038713
④	V3758	Pressure foot set for the removal of screwed wheel bearing units	2	037587

V3732, EAN 4047728037327

Wheel bearing unit, screwed, removal tool set, universal

- Removing screwed wheel bearing units (3 bolts) at the front and rear axle
- Usage of the pressure feet on both sides ensures quick and easy adjustment at the steering knuckle
- Maximum loading capacity: 22 tonnes
- Adjustability guarantees usage with all models of screwed wheel bearing units with 3 bolts currently available on the market
- Can be used directly on the vehicle
- For e.g.:
 - VW Golf 6 Cabrio model years 2013 → · Golf model years → 2012 · Touran model years 2015 → · Tiguan model years 2016 → · Passat model years 2014 →
 - AUDI A3 model years 2012 → · TT model years 2014 → · Q2 model years 2016 →
 - ŠKODA Octavia model years 2012 → · Superb model years 2015 →
 - SEAT León model years 2012 →
 - OPEL/VAUXHALL Insignia · Astra model years 2004 → · Corsa D → 2014
 - CHEVROLET/GMC Malibu
 - SAAB 95 model years 2010 →

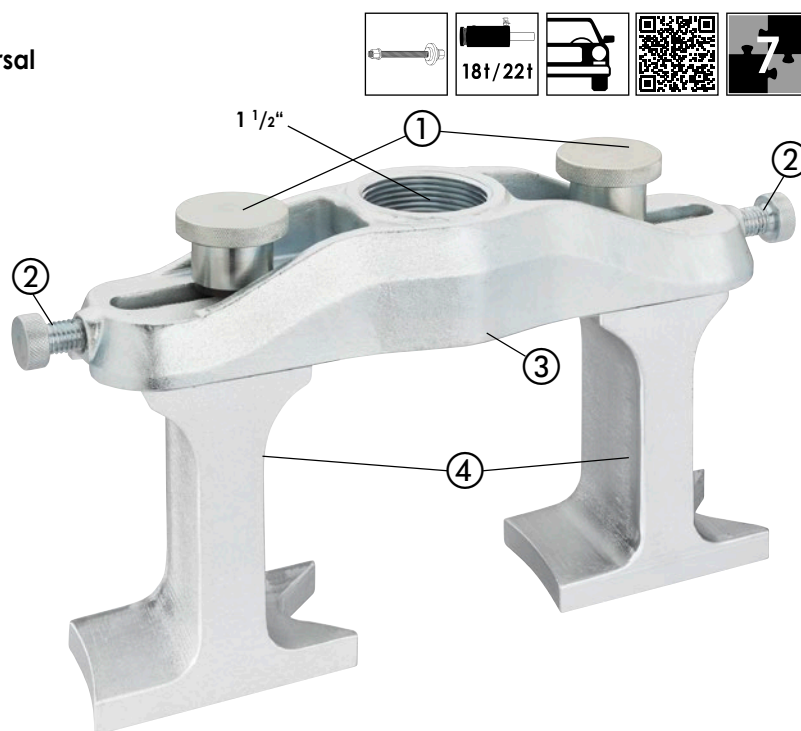
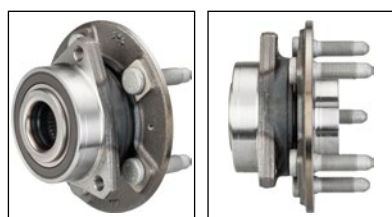

Universally adjustable for screwed wheel bearing units with 3 bolts

	VIGOR No.	Designation	X	EAN 4047728+
①	V3873	Fixing screw M14	2	038737
②	V3874	Screw M12	2	038744
③	V3871	Crossbar	1	038713
④	V3753	Pressure foot set for the removal of screwed wheel bearing units	2	037532

Screwed compact wheel bearing tool sets

V3865, EAN 4047728**038652**

Wheel bearing unit / compact wheel bearing, screwed, removal tool set, universal

- Removal of any types of compact wheel bearings as well as screwed wheel bearing units with 3 and 4 bolts
- Universal set for the removal of all screwed wheel bearing units and compact wheel bearings
- Maximum loading capacity 22 tonnes
- Can be used directly on the vehicle



Can be used directly on the vehicle



Suitable for no. 1



Universal set for installing and removing all screwed wheel bearing units and compact wheel bearings

Suitable for no. 2



Suitable for no. 3



	VIGOR No.	Designation		EAN 4047728+
①	V2860	Removal tool for compact wheel bearings	7	028608
②	V3758	Pressure foot set for the removal of screwed wheel bearing units	2	037587
③	V3753	Pressure foot set for the removal of screwed wheel bearing units	2	037532
④	V2864	Thrust washer, conical, universal	1	028644
⑤	V3033	Support disc Ø 32 mm, inside hole Ø 20.25 mm, suitable for spindle M 20	1	030335

	VIGOR No.	Designation		EAN 4047728+
⑥	V3034	Support disc Ø 40 mm, inside hole Ø 20.25 mm, suitable for spindle M 20	1	030342
⑦	V3035	Support disc Ø 45 mm, inside hole Ø 20.25 mm, suitable for spindle M 20	1	030359
⑧	V3036	Support disc Ø 52 mm, inside hole Ø 20.25 mm, suitable for spindle M 20	1	030366
⑨	V3063	Bearing washer Ø 63 mm, inside hole Ø 20.25 mm, suitable for spindle M 20	1	030632



V3866, EAN 4047728**038669**

Wheel bearing unit and compact wheel bearing, screwed, removal / assembly tool set, universal

- Installation / removal of all screwed wheel bearing units and compact wheel bearings with 3 or 4 bolts
- Maximum loading capacity 22 tonnes
- Can be used directly on the vehicle

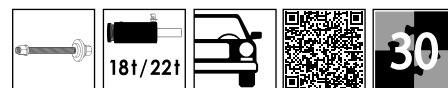

Universal set for the installation and removal of all screwed wheel bearing units and compact wheel bearings



	VIGOR No.	Designation		EAN 4047728+
①	V3865	Removal tool for compact wheel bearings	17	038652

	VIGOR No.	Designation		EAN 4047728+
②	V3680	Universal compact wheel bearing assembly tool set	13	036801



Screwed compact wheel bearing tool sets



V2859, EAN 4047728028592

Thrust washer (installation) FORD · MAZDA · Volvo

- E.g. for:
FORD: Mondeo, Focus, C-Max, S-Max, Kuga
MAZDA: 3 to 6 · 5 · CX7
Volvo: V70 model years 2007→, S40 ·
V50 model years 2004→
LAND ROVER: Freelander 2-14



Inside diameter 20.25 mm
suitable for spindle M 20



V2863, EAN 4047728028639

Mounting ring FORD · MAZDA · Volvo

- Deeper insertion of the compact wheel bearing into the wheel bearing housing
- E.g. for:
FORD: Mondeo · S-Max
MAZDA: 6
Volvo: V70 model year 2007→ ·
S80 · V60 · XC60 · XC70



V2862, EAN 4047728028622

Thrust washer (installation) VW

- E.g. for:
VW: T5 front and rear, Touareg
MERCEDES-BENZ: Vito and Viano rear axle



Inside diameter 20.25 mm
suitable for spindle M 20



V2861, EAN 4047728028615

Thrust washer (installation) VW · AUDI · SEAT · ŠKODA

- E.g. for:
VW: Polo, Lupo, Fox
AUDI: A2
SEAT: Ibiza, Córdoba
ŠKODA: Fabia
SMART: Forfour
MITSUBISHI: Colt



Inside diameter 20.25 mm
suitable for spindle M 20



V7061, EAN 4047728070614

Screw set SUBARU rear wheel bearings

- Removal of rear wheel bearing on the SUBARU using tool V5903 requires longer bearing bolts
- Set consisting of 4 hexagon screws M12x1.25x100 mm for the bearing thread
- Use washers with flat side facing screw head
- For e.g. SUBARU Legacy · Impreza · Forester · Outback · XV



Wheel bearing puller
V5903 optionally available



NEW



V5027, EAN 4047728050272

Wheel hub puller

- Removal of screwed wheel bearing units with closed wheel hub.
- The drive shaft does not have to be removed beforehand anymore
- To be used together with wheel bearing / hub tool V3731 - V3732 as well as hydraulic cylinder 16-22 tonnes
- Bolt circle 4 and 5-hole: 92-131 mm
- Note: Do not load tool with more than 18 tonnes
- For models with closed wheel hub, among others:
 - OPEL/VAUXHALL Insignia model years 2010 → SAAB 9-5 model years 2010 → CITROËN C1 model years 2006 → Jumpy model years 2016 → SpaceTourer model years 2016 → PEUGEOT 108 model years 2015 → Expert model years 2016 → Traveller TOYOTA Aygo model years 2006 → ProAce (Verso) and other models

Wheel hub removal without removing the drive shaft



V5903, EAN 4047728059046

Wheel bearing puller

- Removal of the screwed wheel bearing without removing the drive shaft.
- Removing screwed wheel bearing units (3 or 4 bolts) at the front and rear axle when the wheel hub is removed
- Can be used directly on the vehicle
- Usable only together with V3731 and V3732
- Maximum loading capacity: 18 tonnes
- For e.g.:
 - AUDI: A4, model years 2007 → 2016 · A5, model years 2007 → 2017 · A6, model years 2011 → · A7, model years 2010 → · A8, model years 2010 → · Q5, model years 2008 →

Removal of the screwed wheel bearing without removing the drive shaft

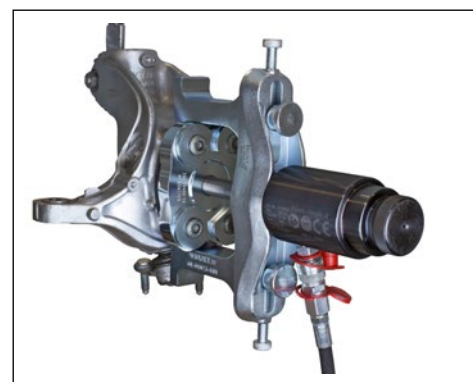

	VIGOR No.	Designation	X	EAN 4047728+
①	V5903-1	Bearing plate	1	059053
②	V5903-2	Washer	4	059060
③	V5903-3	Drawbar M22, 121 mm	1	059077

Screwed compact wheel bearing tool sets



V7050, EAN 4047728**070508**

Removal tool for screwed 4-hole wheel hubs/ wheel bearings with special brake guard

- Flexibly adjustable, especially for models with difficult to access brake guard
- Removal directly on the vehicle
- Owing to the effects of corrosion, these wheel bearing types have a very tight fit and are difficult to remove. The use of the tool prevents damage to the steering knuckle parts or brake guard
- For e.g.: SUBARU Forester · XV · Outback
TOYOTA Aygo 2006 → 2019 · Avensis
CITROËN C1
PEUGEOT 107 · 108
OPEL/VAUXHALL Vectra · Zafira
CHRYSLER Voyager
HYUNDAI i10
SUBARU various models



NEW



V4491, EAN 4047728**044912**

Compact wheel bearing assembly tool set, universal

- Installing compact wheel bearing with or without circlip
- Maximum loading capacity: 22 tonnes
- On e.g.:
VW: Polo · Lupo · Touareg · Fox · T5 front and rear · Crafter
AUDI: A2
SEAT: Ibiza · Córdoba
ŠKODA: Fabia · Rapid · Roomster
FORD: Focus · C-Max · Mondeo · S-Max · Kuga
LAND ROVER: Freelander 2
MAZDA: 3 · 5 · 6 · CX-7
MERCEDES-BENZ: Sprinter · Vito · Viano
MITSUBISHI: Colt
SMART: Forfour
Volvo: V50 · S40 · V70 · S80 · XC60
- Use with hydraulic cylinder, mechanical spindle or workshop press



*Adjustability enables use on all types of
compact wheel bearings currently available
on the market, as well as in the future*

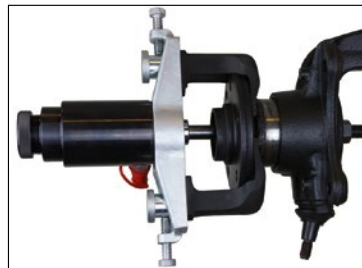
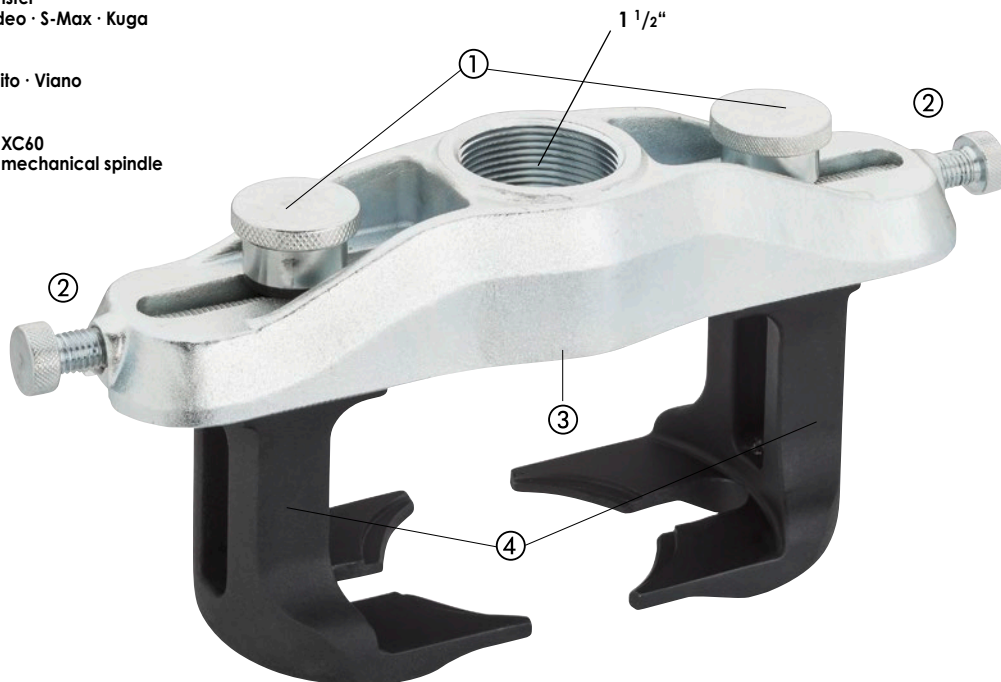

	VIGOR No.	Designation	X	EAN 4047728+
①	V3873	Fixing screw M14	2	038737
②	V3874	Screw M12	2	038744
③	V3871	Crossbar	1	038713
④	V4493	Pressure foot (pair) for universal compact wheel bearing assembly tool set	2	044936



V5906, EAN 4047728059183

Wheel bearing unit, screwed, removal tool set, universal

- Removing screwed wheel bearings with 3 / 4 bolts
- Specially designed pressure feet allow removal of wheel bearings on SUVs and US pickups
- Wheel hubs of sizes up to 180 mm can be removed thanks to the adjustable crossbar
- Heating of components and associated damage is prevented
- Additional use of V5905 does away with the need to remove the drive shaft
- For: DODGE · CHEVROLET/GMC · FORD Ranger model years 2011 →



SUV / van wheel hubs with 6 and 8 stud bolts
Universally adjustable to a diameter of max. 180 mm

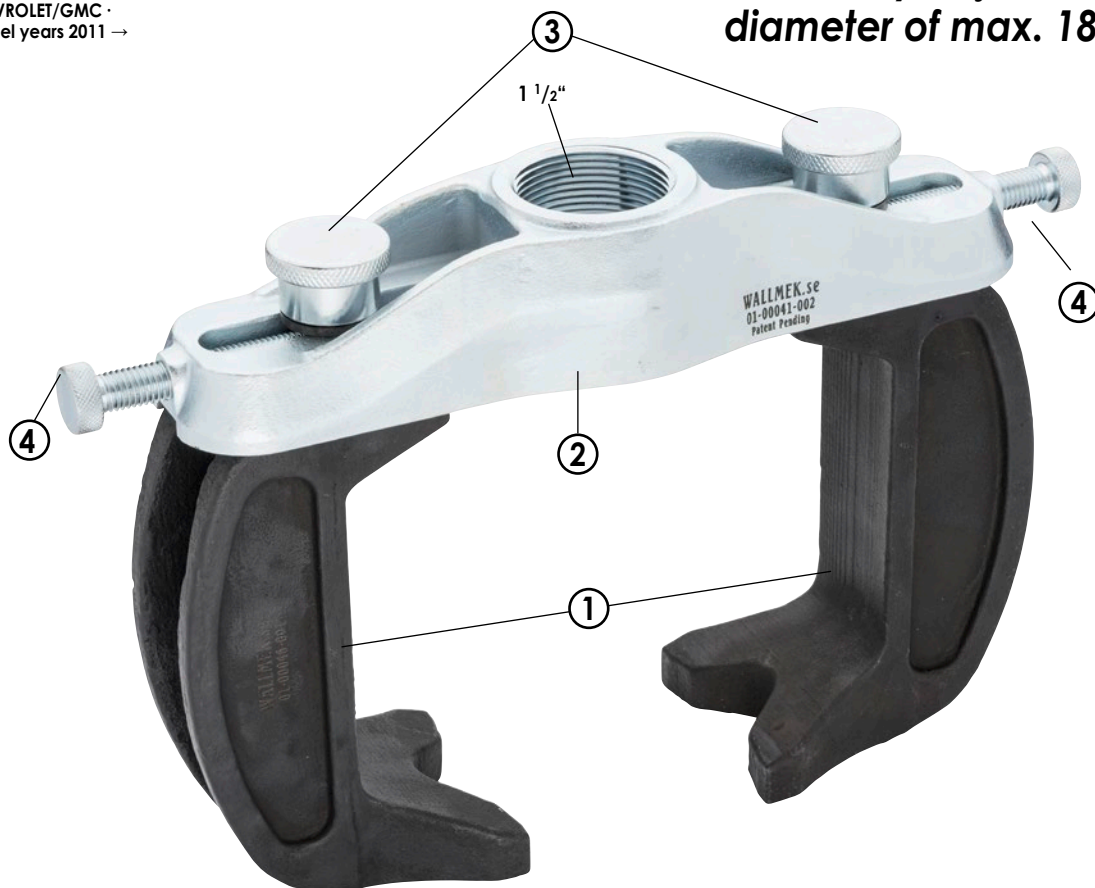

	VIGOR No.	Designation		EAN 4047728+
①	V3873	Fixing screw M14	2	038737
②	V3874	Screw M12	2	038744
③	V5904-2	Fixing plate 1.1/2" thread	1	059121
④	V5906-1	Pressure foot set	2	059190



Wheel hub tool sets with 6 and 8 bolts



V5905, EAN 4047728059152

Wheel hub/wheel bearing puller for 6 and 8 bolts

- Removing screwed wheel bearings and hub units directly on the vehicle
- Only in conjunction with V5906
- No need to remove the drive shaft
- The included M 22 threaded rods connect the tool to one of our hydraulic cylinders
- For bolt circle (6 hole) 111.5 – 142.5 mm, (8 hole) 162.5 – 182.5 mm

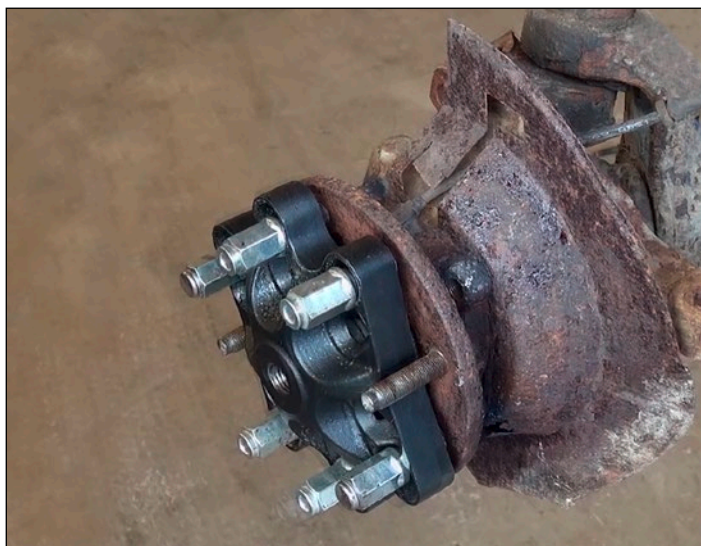

V5904, EAN 4047728059084

Device for the removal of drive shafts, 6- and 8-holes

- For removing rusted and glued drive shafts directly on the vehicle
- For bolt circle (6 hole) 114–140 mm, (8 hole) 165 to 180 mm
- Removal of drive shaft with 22 tonnes hydraulic cylinder (installation of the impact body enables use of additional force by using a hammer)
- Fastening with wheel nuts or wheel bolts on the vehicle



Adjustable, suitable for bolt circle (6 hole) from 114 to 140 mm, (8 hole) from 165 to 180 mm

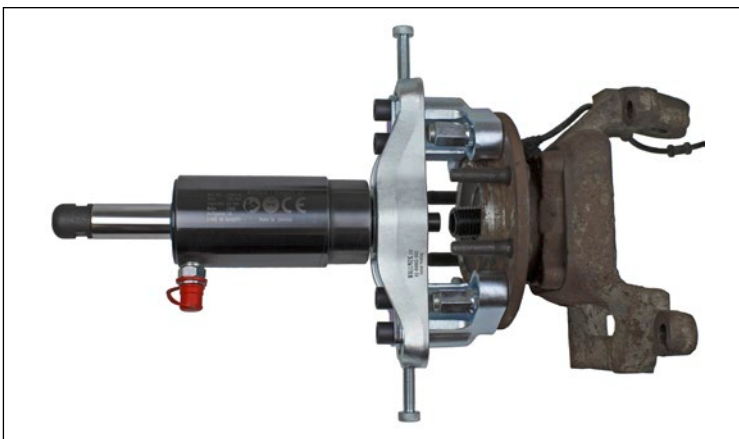
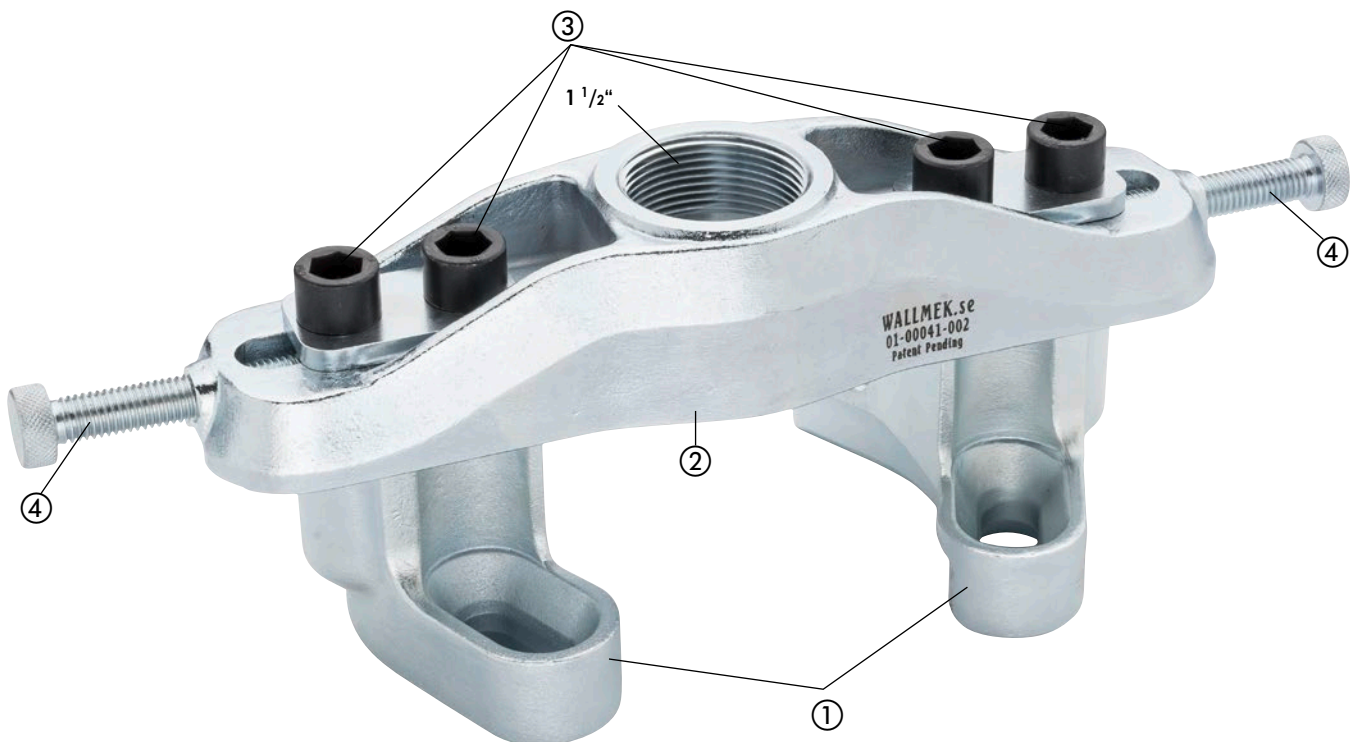

	VIGOR No.	Designation		EAN 4047728+
①	V5904-1	Pressure foot set	2	059114
②	V5904-2	Fixing plate 1.1/2" thread	1	059121
③	V5904-3	Bolt	4	059138
④	V5904-4	Bolt M 14x 45	2	059145



V5128, EAN 4047728**051286**

V4700-XL multibox, wheel hub / wheel bearing removal/assembly tool set, universal

- Click system enables connection and disconnection with associated boxes and mechanic's creeper
- Effective method for disassembling wheel hubs. Recommendation: Use wheel bearing tool set V4598. The set also functions with steering knuckles with uneven and limited surfaces
- Significant time savings compared to earlier systems
- Together with hydraulic cylinder or manual spindle
- Allows the wheel bearings to be changed directly on the vehicle with minimum time spent
- Not necessary to remove the ABS sensor, steering knuckle, strut or steering tie rod
- Wheel alignment and brake bleeding not necessary
- All parts are adapted for the wheel bearing sizes currently found on the market
- Mounting washers have a guide and are usable on both sides
- Mounting washers with \varnothing 62–83 mm and support discs of 34–60 mm are included, the bearing shell is suitable for wheel bearings of up to \varnothing 92 mm



1/2+



V4629

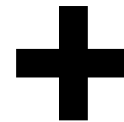

V4598



VIGOR No.	Designation		EAN 4047728+
V4598	Universal wheel bearing / hub and drive shaft set	16	045988
V4629	Universal wheel hub removal tool	7	046299

VIGOR No.	Designation		EAN 4047728+
V4906	Universal wheel hub removal set	23	049061
V4906-L	Soft foam insert, empty	1	049054



V5549, EAN 4047728**055499**

V4700-L multibox, compact wheel bearing / wheel hub expansion set

- Click system enables connection and disconnection with associated boxes and mechanic's creeper
- In combination with the set V4680, all currently known wheel bearings can be assembled and disassembled
- Expansion set adding to e.g. V4680
- Includes pressure feet for disassembling all common wheel hubs
- Additional pressure feet for screwed wheel bearing units (3 and 4 bolts) at the front and rear axle VAG · OPEL/VAUXHALL and many others
- Adjustability guarantees usage with all models of screwed wheel bearing units with 3 and 4 bolts currently available on the market
- E.g. for 4 bolts:
 - AUDI A4, A6
 - VW Passat
 - ŠKODA Octavia
 - SEAT Exeo
- E.g. for 3 bolts:
 - VW Golf 6 Cabrio model years 2013 → · Golf model years → 2012 · Touran model years 2015 → · Tiguan model years 2016 → · Passat model years 2014 →
 - AUDI A3 model years 2012 → · TT model years 2014 → · Q2 model years 2016 →
 - ŠKODA Octavia model years 2012 → · Superb model years 2015 →
 - SEAT León model years 2012 →
 - OPEL/VAUXHALL Insignia, Astra model year 2004 →
 - CHEVROLET/GMC Malibu
 - SAAB 95 model years 2010 →
- Use with crossbar V3871



1/2+



3 bolts screwed wheel bearing units



V3753



4 bolts screwed wheel bearing units



V3758



Two-piece standard wheel bearing



V4629-1



V4598-30

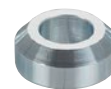
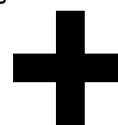

V4598-2

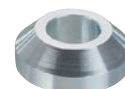

V4598-3

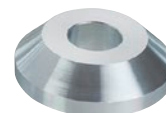

V4598-4

VIGOR No.	Designation		EAN 4047728+
V3753	Pressure foot set for the removal of screwed wheel bearing units	2	037532
V3758	Pressure foot set for the removal of screwed wheel bearing units	2	037587
V4629-1	Pressure foot set for V4629, 2 pieces	2	046305
V4598-30	Pressure pipe length 78 mm, inside hole Ø 20.25 mm, suitable for spindle M 20	1	046282
V4598-2	Support disc, tapered Ø 38.8 mm, inside hole Ø 20.25 mm, suitable for spindle M 20	1	046152

VIGOR No.	Designation		EAN 4047728+
V4598-3	Support disc, tapered Ø 43.8 mm, inside hole Ø 20.25 mm, suitable for spindle M 20	1	046169
V4598-4	Support disc, tapered Ø 59.8 mm, inside hole Ø 20.25 mm, suitable for spindle M 20	1	046176
V5548	Compact wheel bearing / wheel hub expansion set	1	055482
V5548-L	Soft foam insert, empty	1	055475



V5549-1, EAN 4047728070492

V4700-L multibox with compact wheel bearing/wheel hub expansion set

- Click system enables connection and disconnection with associated boxes and mechanic's creeper
- Specially for expanding and completing compact wheel bearing tool sets
- When combined with the base unit V4680, all commercially available compact wheel bearings can be installed and removed
- Set contains 4 expansions:
 1. Disassembly feet for compact wheel bearings screwed with 3 bolts
 2. Disassembly feet for compact wheel bearings screwed with 4 bolts
 3. Disassembly unit of the wheel hub without prior removal of the drive shaft
 4. Disassembly unit of the screwed wheel bearing without prior removal of the drive shaft



14

1/2+

NEW

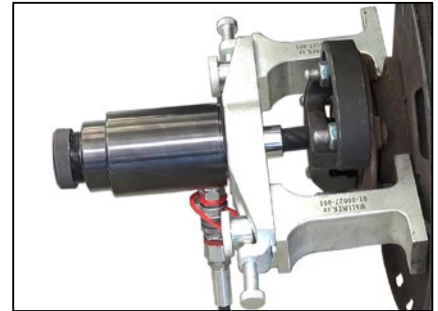
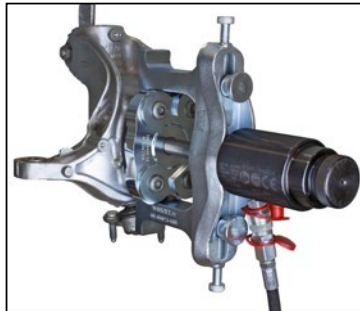
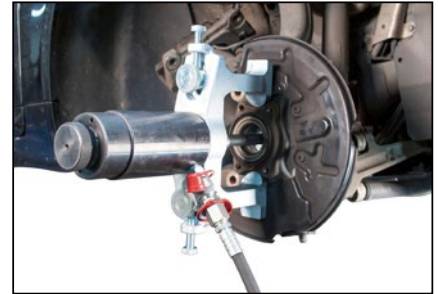

VIGOR No.	Designation	X	EAN 4047728+
V5027	Wheel hub puller	3	050272
V3758	Pressure foot set for the removal of screwed wheel bearing units	2	037587
V3753	Pressure foot set for the removal of screwed wheel bearing units	2	037532

VIGOR No.	Designation	X	EAN 4047728+
V4598-4	Support disc, tapered Ø 59.8 mm, inside hole Ø 20.25 mm, suitable for spindle M 20	1	046176
V5903	Wheel bearing puller	6	059046
V4700-L	Multibox L	-	046794

V5741N, EAN 4047728**070485**

V4700-XL multibox, for FORD, MAZDA, Volvo longitudinal strut and wishbone bushing

- Click system enables connection and disconnection with associated boxes and mechanic's creeper
- Wishbone bushing set, for rear axle bushings
- Changing the bushing (front longitudinal strut in the rear area) and the rear axle bushing
- For e.g.:
 - FORD Focus · Focus Turnier, model years 1999 → · C-Max model years 2003 → · Kuga model years 2008 → · Galaxy model years 2006 → 2015 · Mondeo model years 2007 → 2015 · S-Max model years 2006 → 2014
 - Volvo V50 · S40 · C30, model year 2004 → · C70, model year 2006 → · S40, model year 2002 → 2012 · S60 · S80, model year 2010 → · V50, model year 2005 → 2012 · V60, model year 2010 → · V70, model year 2007 → 2015 · XC60, model year 2008 → · XC70, model year 2002 → 2007
 - MAZDA 3, model year 2003 → 2009 · 5, model year 2005 → 2010



1/2+

NEW

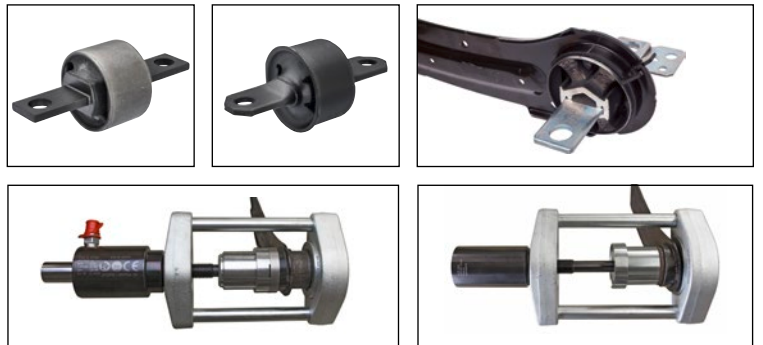

VIGOR No.	Designation	X	EAN 4047728+
V4700-XL	Multibox XL	-	049269
V3056	Screw M16 x 40 mm	4	030564
V5902	Rear axle bushing tool set	1	059022

VIGOR No.	Designation	X	EAN 4047728+
V3649	Bushing set longitudinal strut, FORD / Volvo	4	036498
V3053	Plate with thread	1	030533

V4680, EAN 4047728**046800**

V4700-L multibox, compact wheel bearing removal / assembly tool set, universal

- Maximum loading capacity: 22 tonnes
- On e.g.:
 - VW: Polo · Lupo · Touareg · Fox · T5 front and rear · Crafter
 - AUDI: A2
 - SEAT: Ibiza, Córdoba
 - ŠKODA: Fabia, Rapid, Roomster
 - FORD: Focus, C-Max, Mondeo, S-Max, Kuga
 - LAND ROVER: Freelander 2
 - MAZDA: 3 · 5 · 6 · CX-7
 - MERCEDES-BENZ: Sprinter, Vito, Viano
 - MITSUBISHI: Colt
 - SMART: Forfour
 - Volvo: V50 · S40 · V70 · S80 · XC60 and more models
 - CITROËN: Jumpy (Dispatch), Space Tourer
 - PEUGEOT: Expert, Traveller
 - TOYOTA: ProAce (Verso)
- Use with hydraulic cylinder, mechanical spindle or workshop press



1/2+

Adjustability enables use on all types of compact wheel bearings currently available on the market, as well as in the future

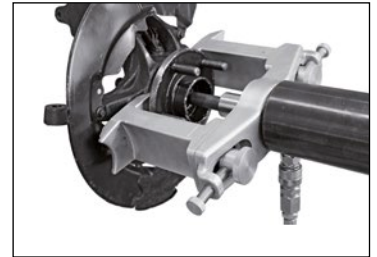

Disassembly

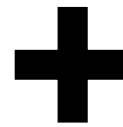

Assembly



VIGOR No.	Designation	X	EAN 4047728+
V2860	Removal tool for compact wheel bearings	7	028608
V2864	Thrust washer, conical, universal	1	028646

VIGOR No.	Designation	X	EAN 4047728+
V3680	Universal compact wheel bearing assembly tool set	13	036801
V4678	Compact wheel bearing removal / assembly tool set, universal	15	046787
V4676	Soft foam insert, empty	1	046763



V5554, EAN 4047728055543

Multibox V4700-L, hydraulic compact wheel bearing, basic set

- Click system enables connection and disconnection with associated boxes and mechanic's creeper
- V4680 Universal tool set for removing and installing compact wheel bearings
- Application on all compact wheel bearings currently available on the market
- Simple adjustment mechanism allows the user to work with bearings of $\varnothing 62 - 96$ mm
- V2854 Tractive and compressive hydraulic cylinder 22 tonnes
- Pressure function - Using this briefly increases the impact when using the impact body. Application e.g. on corroded drive shafts or when working with the press frame
- Automatic piston return function
- V2847 Hydraulic foot pump
- For all VIGOR hydraulic cylinders
- Driving pressure: 700 bar
- Hose length: 2.2 m
- Oil capacity: 0.75 l
- Pump contains a CEJN quick coupler connection
- Set in soft foam insert, with multibox L



1/2+

Universal set for removing and installing all compact wheel bearings



V4680



V2854

Quick coupling, non-drip

V2847



700 bar



0.75 l



2.2 m



VIGOR No.	Designation	X	EAN
V4680	V4700-L multibox with universal compact wheel bearing removal / assembly tool set	15	046800

VIGOR No.	Designation	X	EAN
V2854	Tractive and compressive hydraulic cylinder	10	028547
V2847	Hydraulic foot pump	3	028479

V5554-2, EAN 4047728069021

Multibox V4700-L, hydraulic compact wheel bearing, basic set

- Click system enables connection and disconnection with associated boxes and mechanic's creeper
- V4680 Universal tool set for removing and installing compact wheel bearings
- Application on all compact wheel bearings currently available on the market
- Simple adjustment mechanism allows the user to work with bearings of $\varnothing 62 - 96$ mm
- V2854 Tractive and compressive hydraulic cylinder 22 t
- Using the pressure function greatly increases the impact for a brief period of time when using the impact body
Application e.g. on corroded drive shafts or when working with the press frame
- Automatic piston return function
- V2846 Hydraulic pump, pneumatic
- For all hydraulic cylinders
- Design including manometer

NEW

28
1/2+

Universal set for removing and installing all compact wheel bearings



	VIGOR No.	Designation	X	EAN 4047728+
①	V4680	V4700-L multibox with universal compact wheel bearing removal / assembly tool set	15	046800

	VIGOR No.	Designation	X	EAN 4047728+
②	V2846	Hydraulic pump, pneumatic	3	028462
③	V2854	Tractive and compressive hydraulic cylinder	10	028547



V5169, EAN 4047728051699

Multibox V4700-XL, with pressure sleeve set

- Including 24 pressure sleeves of different sizes
- Sleeves with small diameters are reversible
- Adapter and shaft enable the use of press frame V2885—useful when removing or installing bushings and supporting joints without holes
- Larger sleeves for BMW E 38 / E 39 and MERCEDES-BENZ E-/S-Class, among others
- Set can be mounted on the wall due to the secure fit of the sleeves in foam
- Multibox V4700-L
- Outside dimensions: 464x335x142 mm
- Inside dimensions: 400x300x80 mm

The set therefore covers a total of 61 different inside and outside diameters from 30.5 to 79.7 mm

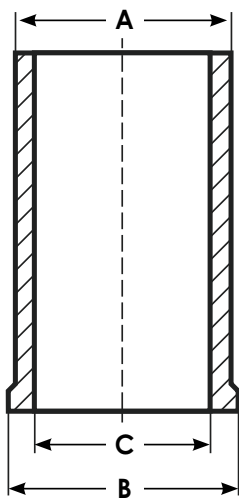
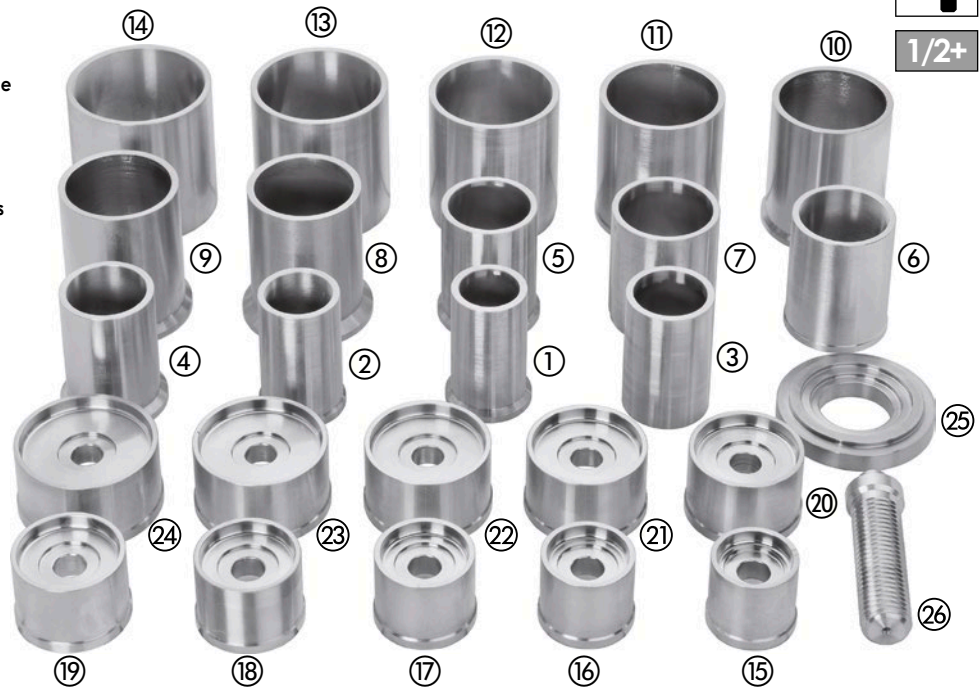

Pressure sleeves, long					
	VIGOR No.	Ø A mm	Ø B mm	Ø C mm	EAN 4047728+
①	V2967	38.7	44.7	30.5	029674
②	V2968	41.7	44.7	34.0	029681
③	V2969	44.7	44.7	37.2	029698
④	V2971	47.7	55.0	40.2	029711
⑤	V2972	50.7	55.0	43.2	029728
⑥	V2973	53.7	55.0	46.2	029735
⑦	V2974	56.7	55.0	49.2	029742
⑧	V2975	59.7	70.0	52.2	029759
⑨	V2976	62.7	70.0	55.2	029766
⑩	V2977	65.7	70.0	58.2	029773
⑪	V2978	68.8	70.0	61.2	029780
⑫	V2979	71.7	70.0	64.2	029797
⑬	V2980	75.7	75.7	68.2	029803
⑭	V2981	79.7	79.7	72.2	029810

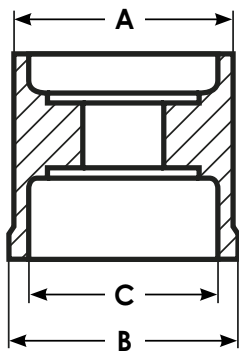

Pressure sleeves, short					
	VIGOR No.	Ø A mm	Ø B mm	Ø C mm	EAN 4047728+
⑮	V2947	40.7	42.5	35.2	029476
⑯	V2948	43.7	45.5	38.2	029483
⑰	V2949	46.7	48.5	41.2	029490
⑱	V2950	49.7	51.5	44.2	029506
⑲	V2961	52.7	54.5	47.2	029612
⑳	V2962	55.7	57.5	50.2	029629
㉑	V2963	58.7	60.5	53.2	029636
㉒	V2964	61.7	63.5	56.2	029643
㉓	V2965	65.7	67.5	60.2	029650
㉔	V2966	69.7	71.5	64.2	029667
㉕	V2945	37	80	-	029452
㉖	V2946	M24 x 90 mm			029469



V5066-L, EAN 4047728050654

Soft foam insert, empty



V5168, EAN 4047728051682

V4700-XL multibox, with drive shaft removal tool set

- Click system enables connection and disconnection with associated boxes and mechanic's creeper
- For removing rusted and glued drive shafts directly on the vehicle
- Working time: approx. 5 minutes only
- For all passenger cars with T4 and 5-hole wheel hubs due to oval holes for wheel bolts
- Prevents heating, splitting of the drive shaft or damage to other parts
- Application: screwing the wheel hub on with the vehicle wheel nuts, removing the drive shaft with a 18 tonnes or 22 tonnes hydraulic cylinder (the installation of the impact body enables additional force by using a hammer), removal of the wheel hub with sliding hammer V2922 and adapter V2872



1/2+



V2849

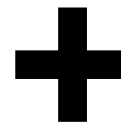

V2854

22 t

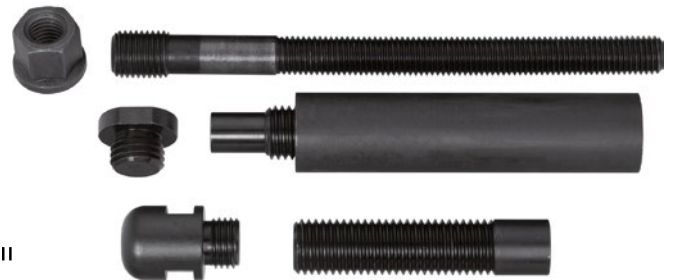

VIGOR No.	Designation	X	EAN 4047728+
V2849	Device for the removal of drive shafts, 4- and 5-holes	2	028493
V2854	Tractive and compressive hydraulic cylinder	10	028547

VIGOR No.	Designation	X	EAN 4047728+
V4904	Set of devices for the removal of drive shafts including 22 tonnes tractive and compressive hydraulic cylinder in soft foam insert	12	049047
V4904-L	Soft foam insert, empty	1	049023



V3740, EAN 4047728037402

Installation tool set for BMW drive shafts (mechanical)

- Manual installation of the drive shaft using the M 22 drawbar and nut
- Adapter made of high-strength steel for drive shafts with M 24x1.5 and M 27 x1.5 threads included
- Installation of the drive shafts in e.g.
 - BMW 5 Series, M 5: 5 GT F07 (model years 2009 → 2015)
 - 5 F10/F11/F18 (model years 2009 → 2015)
 - 5 E60/61 SED/TOU (model years 2002 → 2010)
 - 5 E39 (model years 1995 → 2004)
 - BMW 3 Series, M 3: 3 F30/31 (model years 2012 → 2015)
 - 3 E90/E93 COUPÉ/CAP (model years 2005 → 2015)
 - 3 E92/E93 SED/TOU (model years 2005 → 2012)
 - 3 E46 (model years 1998 → 2005)
 - BMW 7 Series: 7 F01/F02/F03/F04 (model year 2009 → 2015)
 - 7 E65/E66 (model year 2000 → 2008)
 - 7 E38 (model year 1993 → 2001)
 - BMW X5 Series: X5 E70 (model year 2007 → 2015)
 - X5 E53 (model year 1999 → 2001)
 - BMW 1 Series: 1 F20/F21 (model year 2011 → 2015)
 - 1 E82/E88 COUPÉ/CAB (model year 2006 → 2015)
 - 1 E87/E81 5D/3D (model year 2003 → 2011)
 - BMW X3 Series: X3 F25 (model year 2010 → 2015)
 - X3 E83 (model year 2003 → 2010)
 - BMW 6 Series, M 6: 6 F12/F13 (model year 2010 → 2015)
 - 6 E63/64 (model year 2002 → 2010)
 - BMW Z4 Series: Z4 E89 (model year 2009 → 2015)
 - Z4 E85/86 COUPÉ/CAB (model year 2002 → 2008)
 - BMW X6: X6 E71/E72
 - BMW X1: X1 E84 (model year 2010 → 2015)



	VIGOR No.	Designation	mm	X	EAN 4047728+
①	V2969	Pressure pipe A Ø 44.7 mm	-	1	029698
②	V3708	Adapter M24x1.5 mm	-	1	037082
③	V3709	Adapter M27x1.5 mm	-	1	037099
④	V3132	Flange nut M22	-	1	031325
⑤	V3868	Thrust washer (inside diameter 23 mm suitable for spindle M20)	-	1	038683
⑥	V3133	Drawbar M22	250	1	031332



V3751, EAN 4047728037518

Installation tool set for BMW drive shafts (hydraulic)

- Drive shaft installation
- Hydraulic cylinder pulls drive shaft in the correct position without any problems
- E.g. for
 - BMW 5 Series, M 5: 5 GT F07 (model years 2009 → 2015)
 - 5 F10/F11/F18 (model years 2009 → 2015)
 - 5 E60/61 SED/TOU (model years 2002 → 2010)
 - 5 E39 (model years 1995 → 2004)
 - BMW 3 Series, M 3: 3 F30/31 (model year 2012 → 2015)
 - 3 E90/E93 COUPÉ/CAP (model year 2005 → 2015)
 - 3 E92/E93 SED/TOU (model year 2005 → 2012)
 - 3 E46 (model year 1998 → 2005)
 - BMW 7 Series: 7 F01/F02/F03/F04 (model year 2009 → 2015)
 - 7 E65/E66 (model year 2000 → 2008)
 - 7 E38 (model year 1993 → 2001)
 - BMW X5 Series: X5 E70 (model year 2007 → 2015)
 - X5 E53 (model year 1999 → 2001)
 - BMW 1 Series: 1 F20/F21 (model year 2011 → 2015)
 - 1 E82/E88 COUPÉ/CAB (model year 2006 → 2015)
 - 1 E87/E81 5D/3D (model year 2003 → 2011)
 - BMW X3 Series: X3 F25 (model year 2010 → 2015)
 - X3 E83 (model year 2003 → 2010)
 - BMW 6 Series, M 6: 6 F12/F13 (model year 2010 → 2015)
 - 6 E63/64 (model year 2002 → 2010)
 - BMW Z4 Series: Z4 E89 (model year 2009 → 2015)
 - Z4 E85/86 COUPÉ/CAB (model year 2002 → 2008)
 - BMW X6: X6 E71/E72
 - BMW X1: X1 E84 (model year 2010 → 2015)

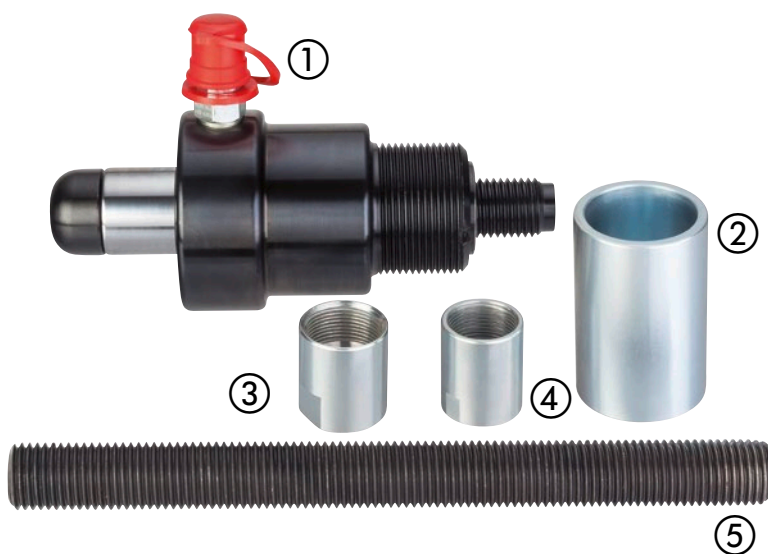

	VIGOR No.	Designation	mm	X	EAN 4047728+
①	V2873	Hydraulic cylinder 8.5 tonnes	-	4	028738
②	V2969	Pressure pipe A Ø 44.7 mm	-	1	029698
③	V3708	Adapter M24x1.5 mm	-	1	037082
④	V3709	Adapter M27x1.5 mm	-	1	037099
⑤	V3133	Drawbar M22	250	1	031332



V2849, EAN 4047728**028493**

Device for the removal of drive shafts, 4- and 5-holes

- For removing rusted and glued drive shafts directly on the vehicle
- For passenger cars with T4 and 5-hole wheel hubs due to oval holes for wheel bolts
- Prevents heating, splitting of the drive shaft or damage to other parts

Application:

- Screw the wheel hub on with the vehicle wheel nuts
- Remove the drive shaft with a 18 tonnes or 22 tonnes hydraulic cylinder.
(The installation of the impact body enables additional force by using a hammer)
- Removal of the wheel hub with sliding hammer V2922 and adapter V2872



Working time: approx. 5 minutes only



	VIGOR No.	Designation		EAN 4047728+
①	V3147	Axle drive shaft, 4-holes, hole circle 92-120 mm	1	031479
②	V3148	Axle drive shaft, 5-holes, hole circle 98-131 mm	1	031486



V2922, EAN 4047728029223

Sliding hammer 5.2 kg

- Removing wheel hub and brake disc
- Used with wheel hub tool set V2871 or adapter V2872 for drive shaft tool V2849
- Sliding hammer, ergonomically shaped



Inside thread: M 18



V2872, EAN 4047728028721

Adapter for sliding hammer V2922

- Adapter to be used with sliding hammer (V2922) and drive shaft tool (V2849) for wheel hub removal



Outside thread: M 18

Outside thread: 1.1/2"



V2871, EAN 4047728028714

Wheel hub removal tool set for V2922

- Removing wheel hubs with sliding hammer V2922

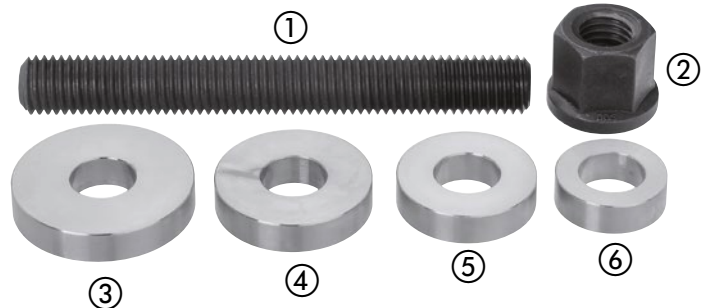

	VIGOR No.	Designation	mm	X	EAN 4047728+
①	V3140	Drawbar M18	150	1	031400
②	V3126	Flange nut M18	-	1	031264
③	V3036	Support disc Ø 52 mm, inside hole Ø 20.25 mm, suitable for spindle M 20	-	1	030366
④	V3035	Support disc Ø 45 mm, inside hole Ø 20.25 mm, suitable for spindle M 20	-	1	030359
⑤	V3034	Support disc Ø 40 mm, inside hole Ø 20.25 mm, suitable for spindle M 20	-	1	030342
⑥	V3033	Support disc Ø 32 mm, inside hole Ø 20.25 mm, suitable for spindle M 20	-	1	030335



V3274, EAN 4047728032742

Wheel bearing tool set, rear MERCEDES-BENZ Vito and Viano

- Changing the wheel bearing on the rear axle on MERCEDES-BENZ Vito and Viano 2003 → 2010 (W639)
- Shape of tool prevents damaging of ABS sensor
- Working time: approx. 30 minutes per side
- Wheel bearings changed directly on the vehicle without time-consuming removal of the strut unit, plus installation of circlip and wheel bearing at the same time

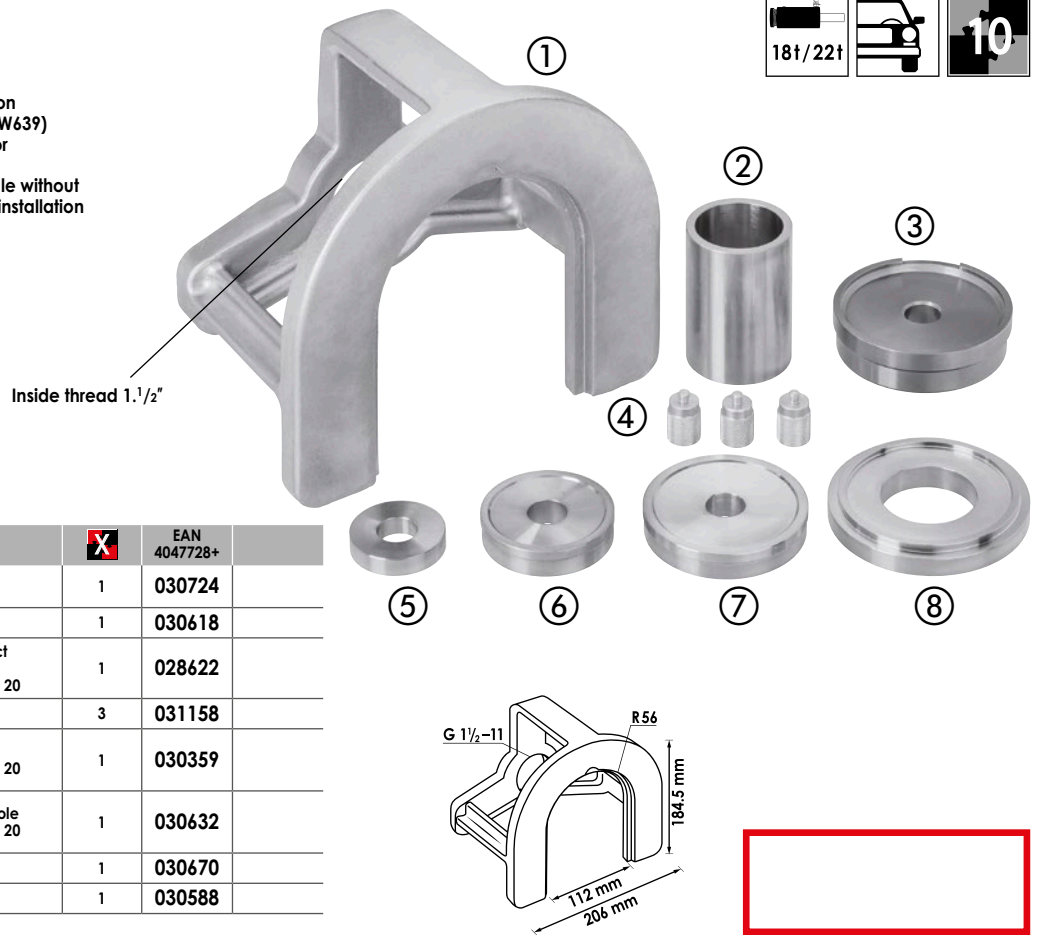

	VIGOR No.	Designation	X	EAN 4047728+
①	V3072	Press frame for drive shaft and hub	1	030724
②	V3061	Pressure pipe	1	030618
③	V2862	Thrust washer for installing compact wheel bearings on VW, inside hole Ø 20.25 mm, suitable for spindle M 20	1	028622
④	V3115	Spacer screw, rear	3	031158
⑤	V3035	Support disc Ø 45 mm, inside hole Ø 20.25 mm, suitable for spindle M 20	1	030359
⑥	V3063	Bearing washer Ø 63 mm, inside hole Ø 20.25 mm, suitable for spindle M 20	1	030632
⑦	V3067	Bearing washer Ø 77.8 mm	1	030670
⑧	V3058	Thrust washer Ø 95 mm	1	030588

V3432, EAN 4047728034326

Wheel bearing tool set, front, RENAULT Master

- Changing the wheel bearings on the front axle RENAULT Master · NISSAN Interstar and OPEL/VAUXHALL Movano, model years 2010 →
- Working time: 40 minutes per side
- Changing of wheel bearings directly on the vehicle in the minimum amount of time

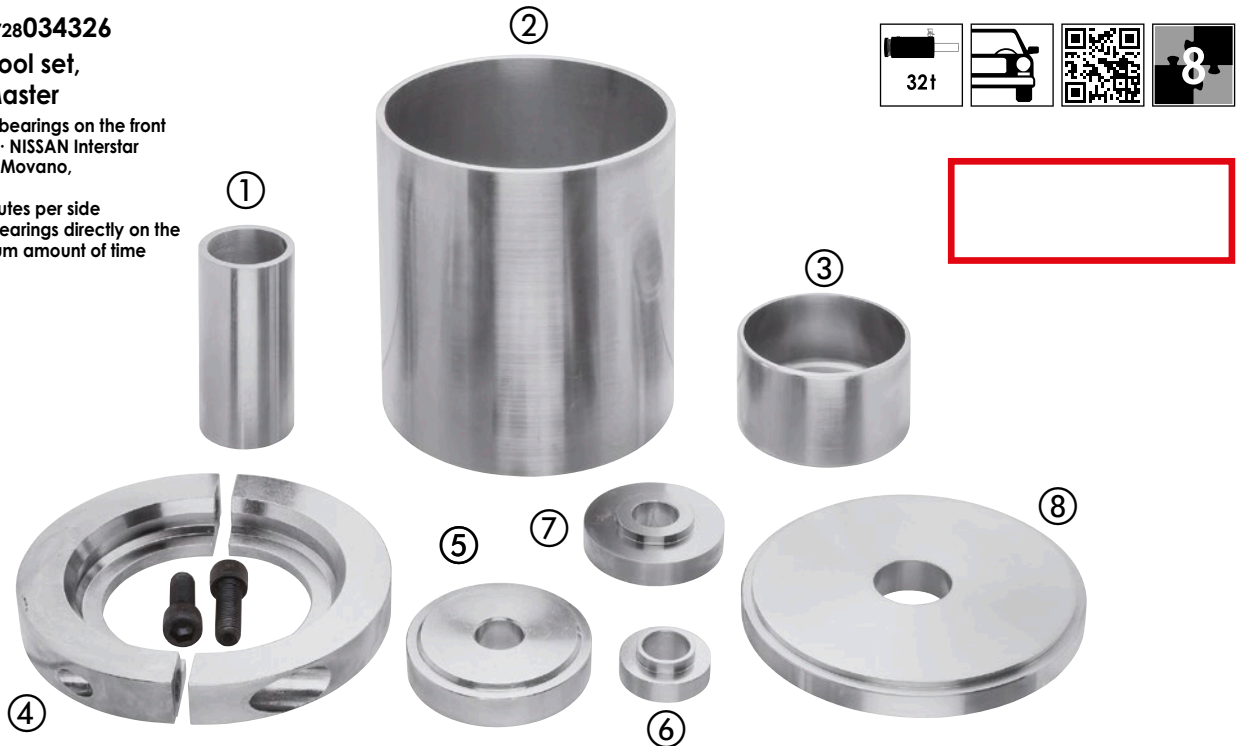

	VIGOR No.	Designation	X	EAN 4047728+
①	V3149	Pressure pipe	1	031493
②	V3107	Pressure pipe	1	031073
③	V3433	Pressure sleeve*	1	034333
④	V2883	Pressure ring set	4	028837

	VIGOR No.	Designation	X	EAN 4047728+
⑤	V3110	Thrust washer Ø 89 mm	1	031103
⑥	V3088	Support disc	1	030885
⑦	V2881	Bearing washer	1	028813
⑧	V3106	Thrust washer Ø 167 mm	1	031066

* Inside diameter 23 mm suitable for M 22 spindle



V2879, EAN 4047728028790

Wheel bearing tool set, front, for FORD

- Changing the wheel bearing on the front axle
- For FORD Transit (Tourneo) model year 2000 →
- Changing the brake disc without damaging the wheel bearing
- For wheel bearings with 78 mm Ø and 87.5 mm Ø
- Working time: approx. 25 minutes per side
- Changing of wheel bearings directly on the vehicle in the minimum amount of time

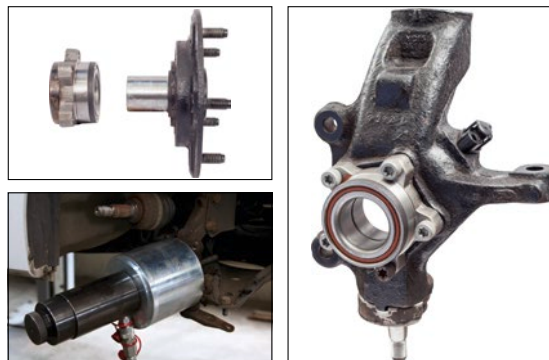

	VIGOR No.	Designation		EAN 4047728+
①	V3087	Wheel hub tool for FORD Transit	1	030878
②	V3040	Pressure pipe, large	1	030403
③	V3149	Pressure pipe	1	031493
④	V2881	Bearing washer*	1	028813
⑤	V3088	Support disc*	1	030885
⑥	V3039	Thrust washer, large	1	030397

* Inside diameter 23 mm suitable for M 22 spindle



V2878, EAN 4047728028783

Wheel bearing tool set, rear, for FORD Transit

- Changing the wheel bearing on the rear axle (presses onto the axle stub)
- Also suitable for the front: for removing rusted and glued drive shafts
- Supplied nuts for M 14x2 thread FORD Transit
- On vans with 5-hole wheel hubs, the wheel hub tool is used with original wheel nuts or wheel bolts
- For bolt circle 119–172 mm

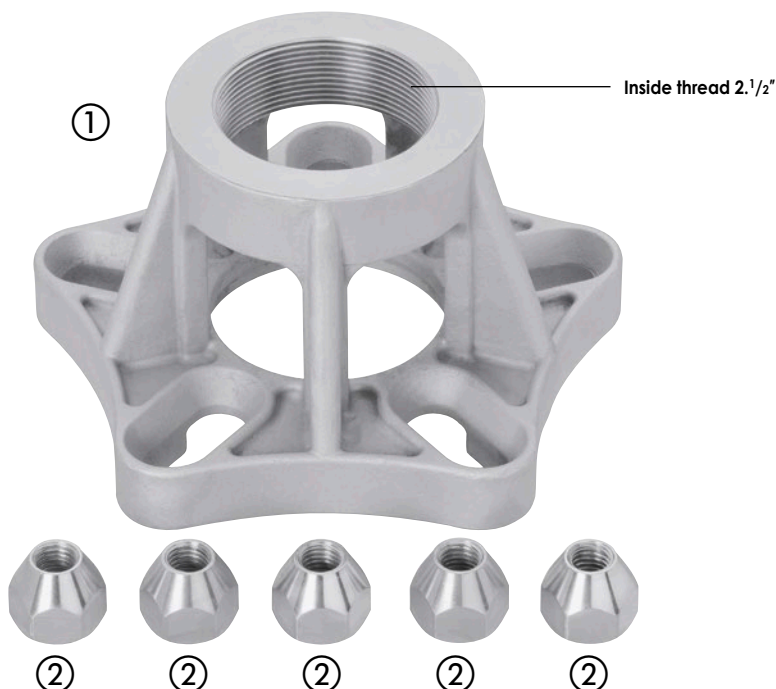

	VIGOR No.	Designation		EAN 4047728+
①	V2890	Drive shaft tool, 5 holes (119–172 mm) for transport vehicles	1	028905
②	V3013	Special nut M14x2 mm	5	030137



V2889, EAN 4047728028899

Wheel bearing tool set, front, for CITROËN · FIAT · PEUGEOT



- E.g. for:
CITROËN: Jumper model years → 2007
FIAT: Ducato model years → 2007
PEUGEOT: Boxer model years → 2007
- Changing of wheel bearings directly on the vehicle in the minimum amount of time
- Disassembly of wheel hubs and bearings on the chassis with the aid of the 32 tonnes hydraulic cylinder (V2874) together with impact force
- Working time: 30–40 minutes per side
- Application only in conjunction with bearing washer (V2881) and support disc (V2882)
- For models since 2007 pressure ring V2883 must be used



	VIGOR No.	Designation	X	EAN 4047728+
①	V3105	Pressure ring	1	031059
②	V3107	Pressure pipe	1	031073
③	V3149	Pressure pipe	1	031493
④	V3091	Support disc*	1	030915
⑤	V3108	Bearing washer*	1	031080
⑥	V3109	Counterholder	1	031097
⑦	V3106	Thrust washer Ø 167 mm	1	031066

* Inside diameter 23 mm suitable for M 22 spindle



V2883, EAN 4047728028837

Pressure ring for wheel bearing tool set, front, for CITROËN · FIAT · PEUGEOT

- Supplementary tool e.g. for
CITROËN Jumper model years 2007 →
FIAT Ducato model years 2007 →
PEUGEOT Boxer model years 2007 →
- For vehicles, model years 2007 → – use with V2889
- This pressure ring set must be used instead of pressure ring set V3105



V2881, EAN 4047728028813

Bearing washer for wheel bearing tool set, front, for CITROËN · FIAT · PEUGEOT

- Required for wheel bearing tool set front (V2889) if wheel bearing tool set rear (V2880) is not to hand

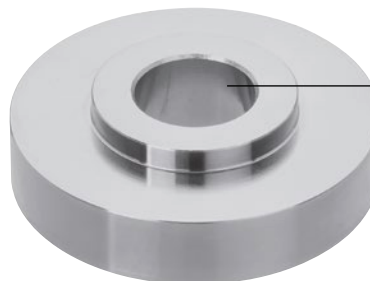

Inside diameter: 23 mm



V2882, EAN 4047728028820

Support disc for wheel bearing tool set, front, for CITROËN · FIAT · PEUGEOT

- Required for wheel bearing tool set front (V2889) if wheel bearing tool set rear (V2880) is not to hand



Inside diameter: 23 mm



V2880, EAN 4047728028806

Wheel bearing tool set, rear, for CITROËN · FIAT · PEUGEOT

- E.g. for:
CITROËN: Jumper
FIAT: Ducato
PEUGEOT: Boxer
- Changing of wheel bearings directly on the vehicle in the minimum amount of time
- Disassembly of wheel hubs and bearings on the chassis with the aid of the 32 tonnes hydraulic cylinder (V2874) together with impact force
- Drive shaft tool for 5-hole van
- For bolt circle 119–172 mm

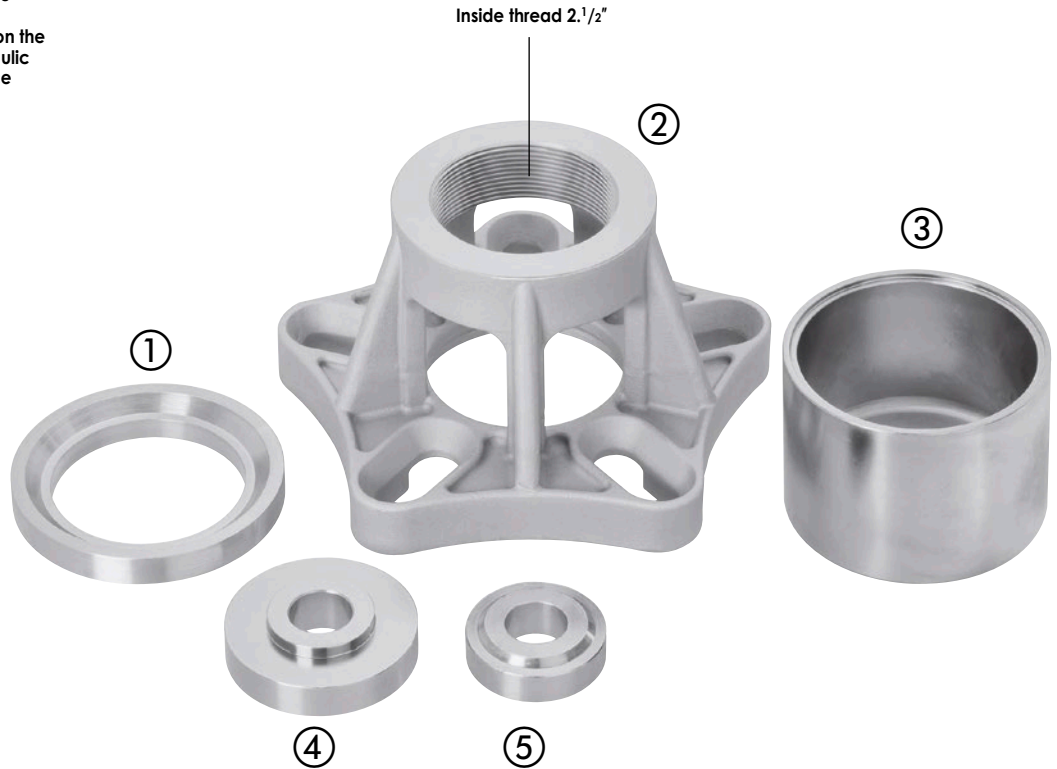

	VIGOR No.	Designation	X	EAN 4047728+
①	V3090	Adapter ring	1	030908
②	V2890	Drive shaft tool, 5 holes (119–172 mm) for transport vehicles	1	028905
③	V3021	Pressure sleeve	1	030212
④	V2881	Bearing washer*	1	028813
⑤	V2882	Support disc CITROËN / FIAT / PEUGEOT wheel bearing tool set, front*	1	028820

* Inside diameter 23 mm suitable for M 22 spindle



V2875, EAN 4047728028752

Wheel bearing tool set, front, for NISSAN · OPEL/VAUXHALL · RENAULT

- E.g. for:
NISSAN: Primastar model year 2002 →
OPEL/VAUXHALL: Vivaro model year 2002 →
RENAULT: Trafic model year 2002 →
- Allows the wheel bearing to be changed directly on the vehicle
- Working time: 20–30 minutes per side



	VIGOR No.	Designation	X	EAN 4047728+
①	V3107	Pressure pipe	1	031073
②	V3061	Pressure pipe	1	030618
③	V3069	Bearing washer Ø 87.8 mm	1	030694
④	V3060	Counterholder, inside hole Ø 20.25 mm, suitable for spindle M 20	1	030601
⑤	V3106	Thrust washer Ø 167 mm	1	031066
⑥	V3068	Bearing washer Ø 82.9 mm*	1	030687
⑦	V3114	Bearing washer Ø 87 mm	1	031141
⑧	V3088	Support disc	1	030885

* Inside diameter 20.25 mm suitable for M 20 spindle



V2888, EAN 4047728028882

Wheel bearing tool set, front, for NISSAN · OPEL/VAUXHALL · RENAULT

- E.g. for (model year 2002→2010):
NISSAN: Interstar
OPEL/VAUXHALL: Movano
RENAULT: Master
- Changing of front wheel bearing directly on the vehicle
- The bearing is removed from the vehicle interior
- Working time: 40 minutes per side



Wheel hub disassembly

Wheel bearing disassembly

Wheel bearing assembly

Wheel hub assembly

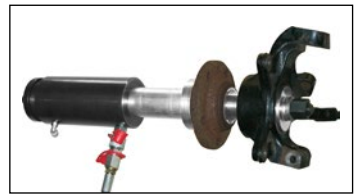
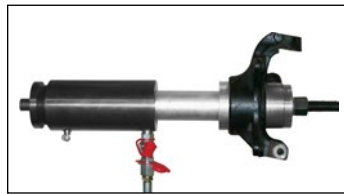
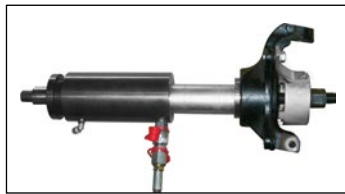
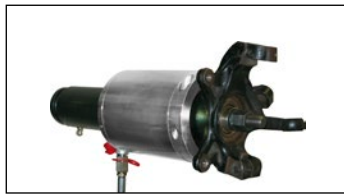

	VIGOR No.	Designation	X	EAN 4047728+
①	V3112	Bearing shell	1	031127
②	V3107	Pressure pipe	1	031073
③	V3149	Pressure pipe	1	031493
④	V3110	Thrust washer Ø 89 mm	1	031103
⑤	V3113	Pressure ring set Ø 89 mm	1	031134

	VIGOR No.	Designation	X	EAN 4047728+
⑥	V3106	Thrust washer Ø 167 mm	1	031066
⑦	V3111	Thrust washer	1	031110
⑧	V2881	Bearing washer	1	028813
⑨	V3088	Support disc	1	030885

V3433, EAN 4047728034333

Pressure sleeve

- Supplementary tool for a/m models 2010 →
- This pressure sleeve must be used instead of bearing shell V3112



V2883, EAN 4047728028837

Pressure ring for wheel bearing tool set, front, for CITROËN · FIAT · PEUGEOT

- Supplementary tool e.g. for
CITROËN Jumper model years 2007 →
FIAT Ducato model years 2007 →
PEUGEOT Boxer model years 2007 →
- For vehicles, model years 2007 → – use with V2889
- This pressure ring set must be used instead of pressure ring set V3105



V2890, EAN 4047728028905

Drive shaft tool, 5 holes, for transport vehicles

- For removing rusted and glued drive shafts directly on the vehicle
- For vans with 5-hole wheel hub due to eccentric holes for wheel bolts
- For bolt circle 119–172 mm
- Prevents heating, splitting of the drive shaft or damage to other parts



Working time: approx. 5 minutes only



V3287, EAN 4047728032872

Special nut M 16x1.5 mm

- Used together with the drive shaft tool V2890 for the removal of wheel bearings (rear) or for pressing out the drive shafts (front)
- For:
 - CITROËN Jumper
 - PEUGEOT Boxer
 - FIAT Ducato
 - RENAULT Master
- 5 nuts required



V3013, EAN 4047728030137

Special nut M 14x2 mm

- Used together with the drive shaft tool V2890 for the removal of wheel bearings (rear) or for pressing out the drive shafts (front)
- For FORD Transit
- 5 nuts required



V5916-XL, EAN 4047728066471

Ball joint ejector, hydraulic 8.8 tonnes

- For the hydraulic removal of the ball joint pivots on tie rods as well as stabilisers, or steering and brake lever for trucks and buses, with a maximum compressive force of 8.8 tonnes
- Height adjustment 81 and 113 mm as well as adjustable diameter to 42 and 56 mm
- The design optimises access to hard-to-reach areas
- The tool can, with the help of the spacer rings provided, be set at various stroke lengths
- Pressure feet installed on both sides to enable work in areas with restricted access
- The safety strap provided prevents the tool from falling down after use
- Operation with hydraulic pump V2846 · V2847 (700 bar)
- Specially for modern aluminium steering knuckles with conically tapered screws installed
- \approx 7.0 kg

NEW



8,8 t

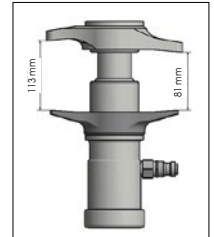

V5916, EAN 4047728059817

Ball joint ejector, hydraulic 4.5 tonnes

- For the hydraulic removal of the ball joint pivots on tie rods as well as stabilisers with a maximum compressive force of 4.5 tonnes
- Height adjustment 60 and 72 mm as well as adjustable diameter to 26 and 32 mm
- The design optimises access to hard-to-reach areas
- The tool can, with the help of the spacer ring provided, be set at various stroke lengths
- Pressure feet installed on both sides to enable work in areas with restricted access
- The safety strap provided prevents the tool from falling down after use
- Operation with hydraulic pump V2846 and V2847 (700 bar)
- Specially for modern aluminium steering knuckles with conically tapered screws installed
- \approx 3.5 kg

NEW

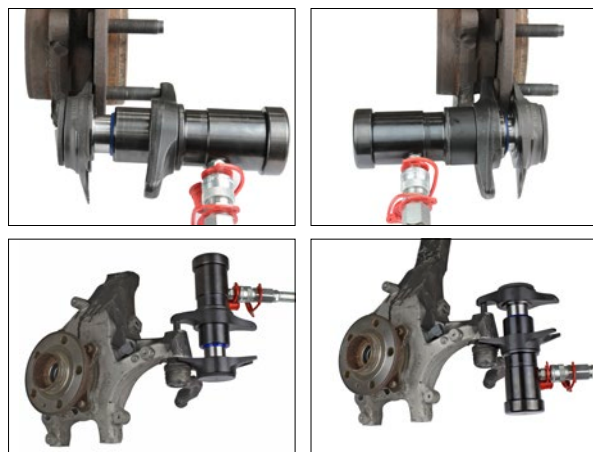

4,5 t

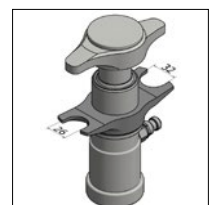
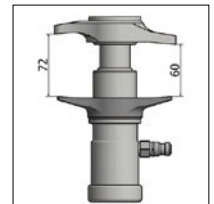

V2885, EAN 4047728028851

Press frame with open plate with adapter to close the plate

- Changing supporting joints and rear axle bushings
- Open press frame plate is closed by the adapter ring
- Inside diameter of both struts at 118 mm

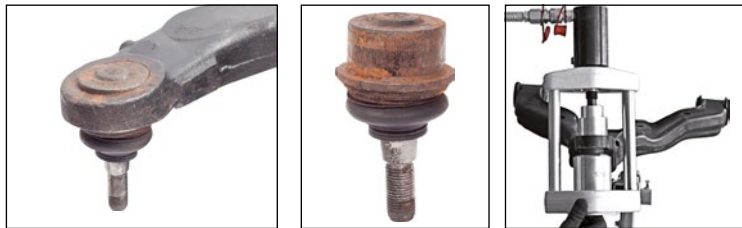

	VIGOR No.	Designation		EAN 4047728+
①	V3053	Plate with thread	1	030533
②	V3055	Support	2	030557
③	V3142	Adapter plate	1	031424
④	V3057	Open plate	1	030571
⑤	V3056	Screw M16x40 mm	4	030564

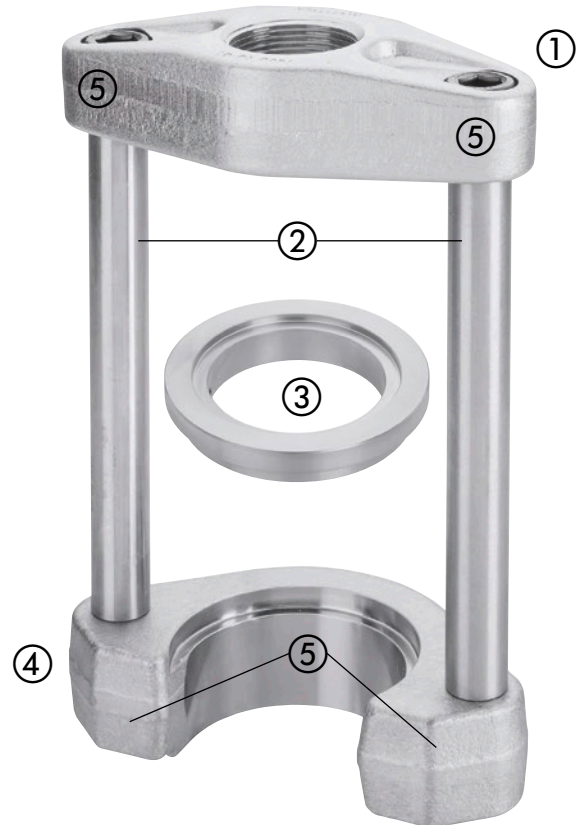

Table of pressure pieces for different passenger cars

Type	Thrust block
BMW E30, E36 (inside)	V2906, V2905, V2904
BMW E36 (outside)	V2909, V2908, V2907
MERCEDES-BENZ type 124	V2906, V2905, V2902
MERCEDES-BENZ Sprinter	V2901, V2900
MERCEDES-BENZ Sprinter 2007 →	V2895, V2894, V2893
DACIA Logan I (model years 2006 → 2013), RENAULT Clio 3 (model years 2006 → 2013), RENAULT Grand Scénic 1 (model years 2003 → 2009), RENAULT Laguna 1, RENAULT Mégane 2, RENAULT Modus (model years 2005 → 2013), RENAULT Scénic 2	V2906, V2892, V2891
NISSAN Interstar, OPEL/ VAUXHALL Movano, RENAULT Master	top: V2899, V2897
	bottom: V2903, V2899, V2898
VW T4	V2901, V2899
VW LT 35	V2901, V2900
VW Crafter	V2895, V2894, V2893
HYUNDAI Trajet, Santa Fé	V2898, V2896, V2892

Table of pressure pieces

VIGOR No.	EAN 4047728+
V2891	028912
V2892	028929
V2893	028936
V2894	028943
V2895	028950
V2896	028967
V2897	028974
V2898	028981
V2899	028998
V2900	029001
V2901	029018
V2902	029025
V2903	029032
V2904	029049
V2905	029056
V2906	029063
V2907	029070
V2908	029087
V2909	029094



V3649, EAN 4047728036498

Bushing set longitudinal strut, FORD · Volvo

- Changing the bushing of the front longitudinal strut in the rear area
- Do not load the bushing and press frame with more than 16 tonnes
- For e.g.:
 FORD: Mondeo · Tourneo model year 2000 → 2007
 FORD: model year 2007 →: Mondeo, S-Max, Galaxy
 Volvo: model year 2007 →: S60 · S80 · V60 · V70 · XC60 · XC70



**Working time:
15 minutes per
change**

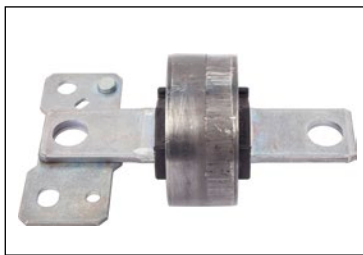

**Use only in
conjunction with
V3053 and V3056**

	VIGOR No.	Designation	X	EAN 4047728+
①	V3650	Press frame	1	036504
②	V3403	Pressure pipe	1	034036
③	V3405	Adapter ring	1	034050
④	V3404	Pressure plate	1	034043



V3053, EAN 4047728030533

Plate with thread

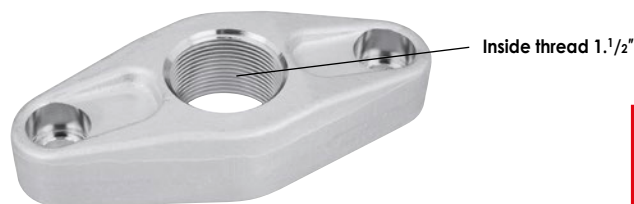

V3056, EAN 4047728030564

Screw M 16 x 40 mm



V2913, EAN 4047728029131

Supporting joint tool set MERCEDES-BENZ

- Changing supporting joint
- MERCEDES-BENZ E-Class, model 211 · 219 · S-Class model 220 · SL-Class model 230
- With supporting joint dismounting bushing V2915, also suitable for MERCEDES-BENZ ML 163
- To be used together with press frame (V2858), only



	VIGOR No.	Designation	mm	X	EAN 4047728+
①	V3047	Pressure sleeve	-	1	030472
②	V3048	Mounting bushing	-	1	030489
③	V3049	Dismounting ring	-	1	030496
④	V3129	Adjustable pressure piece M24	132	1	031295



V2915, EAN 4047728029155

Supporting joint dismounting bushing, MERCEDES-BENZ

- For MERCEDES-BENZ ML 163
- Application in conjunction with V2913
- To be used together with press frame (V2858), only



V2923, EAN 4047728029230

Supporting joint tool set FORD

- For FORD Transit
- Working directly on the vehicle
- Working time: 10 minutes
- To be used together with press frame (V2858), only

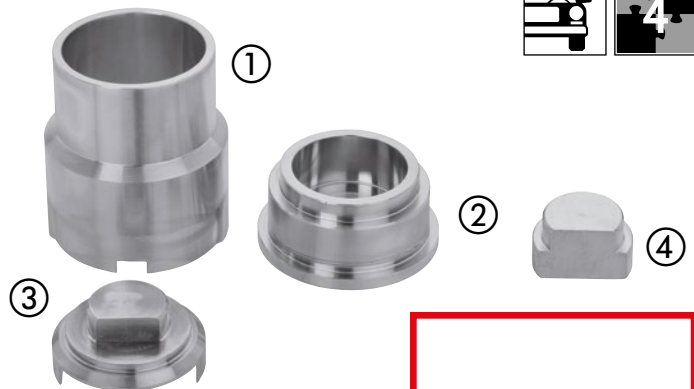

	VIGOR No.	Designation	X	EAN 4047728+
①	V2999	Pressure sleeve	1	029995
②	V3000	Mounting / dismounting cap	1	030007
③	V3001	Mounting bushing	1	030014
④	V3002	Dismounting bushing	1	030021



V2914, EAN 4047728029148

Stabilizer ball joint tool set MERCEDES-BENZ

- For MERCEDES-BENZ: E-Class, model 211 and S-Class model 220
- Only remove the stabiliser – Removing the shock absorbers or the control arm mounting is not necessary
- To be used together with press frame (V2858), only



	VIGOR No.	Designation	X	EAN 4047728+
①	V3045	Pressure sleeve	1	030458
②	V3046	Pressure sleeve	1	030465



V2886, EAN 4047728028868

Rear axle bushing tool set VW · AUDI · SEAT · ŠKODA

- Changing rear axle bushings
- For e.g.:
 - AUDI A3 (8L), model years 1997 → 2003 · TT (8N), model years 1999 → 2006
 - VW Beetle (I), model years 1998 → 2010 · Bora, model years 1998 → 2005 · Golf 4, model years 1997 → 2008 · Polo (4), model years 2002 → 2012
 - SEAT Ibiza (3), model years 2002 → 2009 · León (I), model years 1999 → 2006 · Toledo (2), model years 1999 → 2005
 - ŠKODA: Fabia (I), model years 2000 → 2008 · Octavia (I), model years 1998 → 2010 · Roomster, model years 2006 → · Rapid, model years 2012 →
- Only in conjunction with V2885

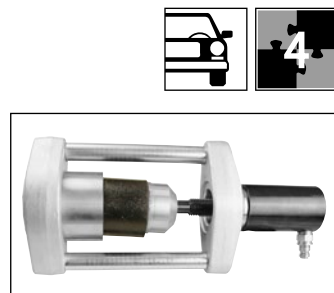

Working time:
approx. 20 minutes

	VIGOR No.	Designation		EAN 4047728+
①	V3214	Mounting bushing	1	032148
②	V3212	Dismounting ring	1	032124
③	V3213	Dismounting bushing	1	032131
④	V3215	Mounting ring	1	032155



V5902, EAN 4047728059022

Rear axle bushing tool set

- For rear axle bushings on e.g.:
 - FORD Focus, model years 1999 → · Focus, model years 2018 → · C-Max, model years 2003 → · Kuga, model years 2008 →
 - MAZDA 3, model years 2003 → · 5, model years 2005 → 2011
 - Volvo V50 · S40 · C30, model years 2004 → · C70, model years 2006 →
- Only in conjunction with V2885



V2884, EAN 4047728028844

Rear axle bushing tool set RENAULT

- For RENAULT Laguna 2
- Working time: approx. 10 minutes per side
- Only in conjunction with V2885

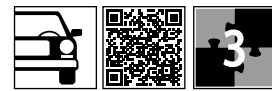

	VIGOR No.	Designation		EAN 4047728+
①	V3094	Pressure sleeve	1	030946
②	V3095	Pressure sleeve	1	030953
③	V3093	Pressure sleeve	1	030939



V2916, EAN 4047728029162

Silent block bushing tool set, rear, BMW

- Changing the rear silent block bushings
- For e.g.:
BMW E53 (X) · E60-65 (5 · 6 · 7 Series), E81 · E82 · E82E, E87 · E87N · E88 (1 Series), E 90 (1 · 3 Series) · E90N · E91 · E91N · E92N · E93 · E93N (3 Series)
- Working time: approx. 45 minutes for all four bushings

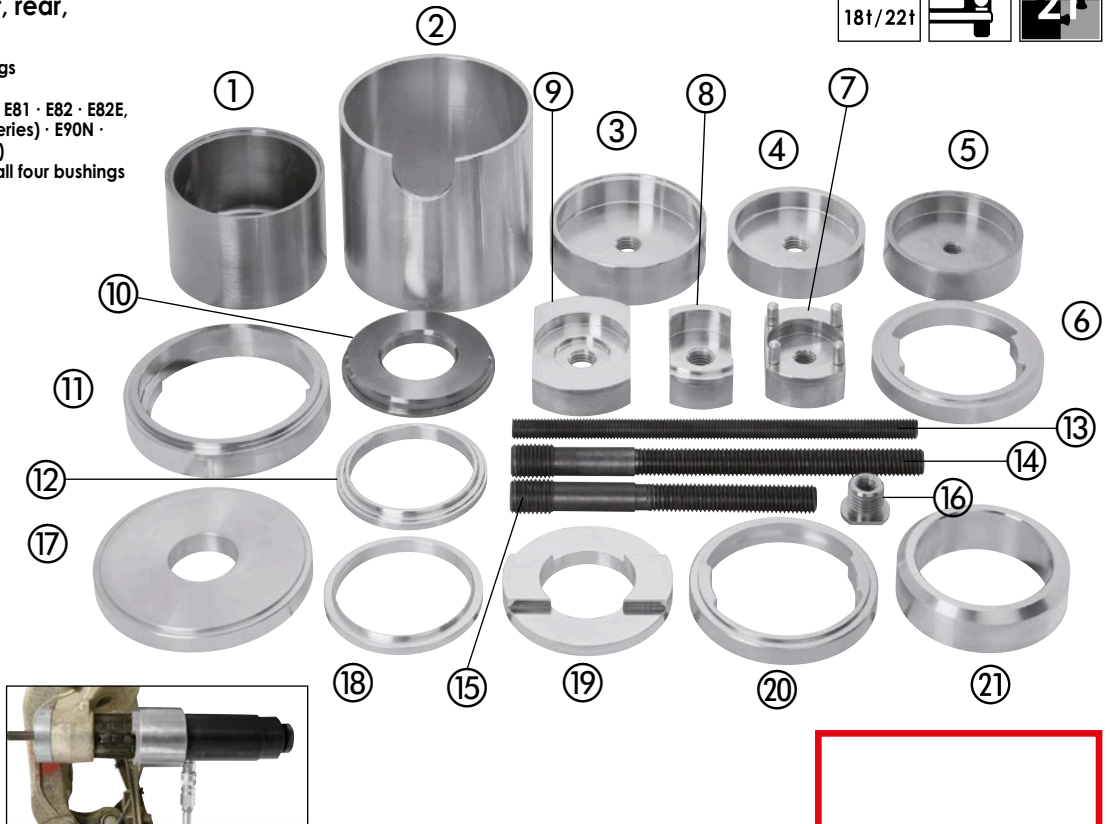

VIGOR No.	Designation	mm	X	EAN 4047728+
①	V3021 Pressure sleeve	-	1	030212
②	V3026 Pressure pipe	-	1	030267
③	V3024 Retaining washer E32/E34	-	1	030243
④	V3020 Mounting washer	-	1	030205
⑤	V3025 Mounting washer	-	1	030250
⑥	V2996 Counterholder	-	1	029964
⑦	V2997 Washer with thread	-	1	029971
⑧	V3028 Washer with thread	-	1	030281
⑨	V3031 Washer with thread	-	1	030311
⑩	V3023 Thrust washer	-	1	030236
⑪	V3019 Retaining ring	-	1	030199

VIGOR No.	Designation	mm	X	EAN 4047728+
⑫	V2995 Mounting ring	-	1	029957
⑬	V3136 Drawbar M14	250	1	031363
⑭	V3127 Drawbar M18 / M22	250	1	031271
⑮	V3139 Drawbar M18 / M22	180	1	031394
⑯	V3135 Adapter M22-M14	-	1	031356
⑰	V3027 Thrust washer	-	1	030274
⑱	V3030 Mounting ring	-	1	030304
⑲	V2998 Thrust washer	-	1	029988
⑳	V3022 Retaining ring E32/E34	-	1	030229
㉑	V3029 Retaining ring	-	1	030298

V3256, EAN 4047728032568

Silent block bushing tool, rear, BMW X5, E53

- Changing the rear silent block bushings
- On BMW X5, E53 rear
- Working time: approx. 45 minutes for all four bushings

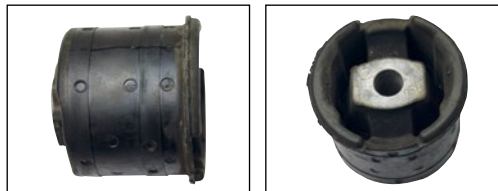

VIGOR No.	Designation	mm	X	EAN 4047728+
①	V3026 Pressure pipe	-	1	030267
②	V3021 Pressure sleeve	-	1	030212
③	V3023 Thrust washer	-	1	030236
④	V3127 Drawbar M18 / M22	250	1	031271
⑤	V3027 Thrust washer	-	1	030274
⑥	V3019 Retaining ring	-	1	030199
⑦	V3020 Mounting washer	-	1	030205
⑧	V3302 Washer with thread*	-	1	033022



* Inside diameter 23 mm suitable for M 22 spindle

V2857, EAN 4047728028578

Tool set for silent blocks VW · AUDI · SEAT · ŠKODA

- Changing the silent block
- VW: Polo 9N, model years 2002 → 2009 · Fox model years 2005 → · Caddy 3 · Eos model years 2006 → · Golf 5 model years 2003 → · Tiguan model years 2007 →
- AUDI: A2, model years 2000 → 2005 · A3 model years 2003 →
- SEAT: Ibiza · Altea · Córdoba, model years 2003 → 2005 · Córdoba · Ibiza model years 2002 → · Altea model years 2004 → · León model years 2005 →
- ŠKODA: Fabia, model years 2000 → 2004 · Roomster model years 2006 → · Octavia 2004 →
- Changing the rear bushing of the triangular control arm
- For manual use

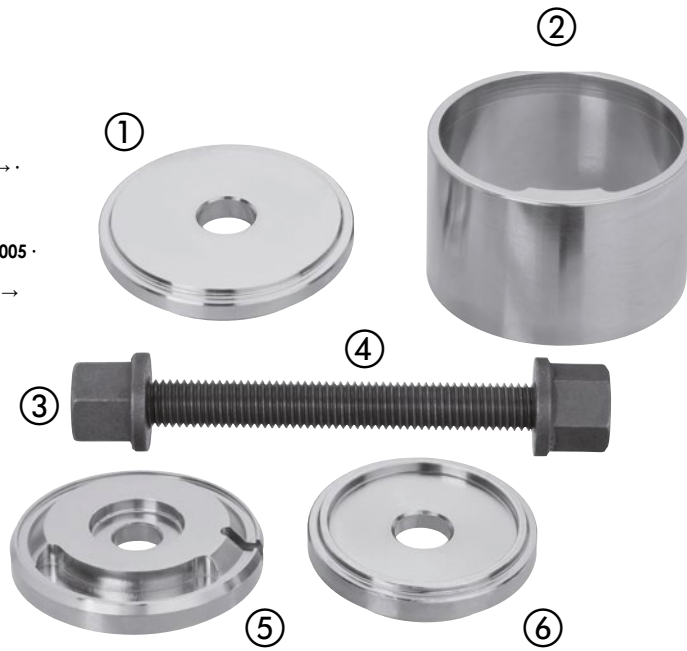

	VIGOR No.	Designation	mm	X	EAN 4047728+
①	V3016	Mounting washer	-	1	030168
②	V3015	Pressure pipe	-	1	030151
③	V3137	Flange nut M14	-	2	031370
④	V3138	Drawbar M14	150	1	031387
⑤	V3014	Dismounting/mounting washer	-	1	030144
⑥	V3017	Dismounting washer	-	1	030175



V3436, EAN 4047728034364

Tool set for double silent blocks VAG

- For:
 - VW: Caddy 3 (2004 → 2010), Eos (2006 →), Golf 5 (2003 → 2009), Golf 6 (2008 →), Golf 7 (2012 →), Scirocco (2005 →), Jetta 3 (2005 → 2010), Passat (2005 → 2010), Tiguan (2007 →), Touran (2003 →)
 - SEAT: Altea (2004 →), León (2005 →), Toledo (2004 → 2009)
 - ŠKODA: Octavia (2004 → 2010)
 - AUDI: A3 (2005 →), TT (2006 → 2010)
- Note: Due to limited space on the vehicle, we recommend replacing the silent block using a workshop press
- Extraction / insertion with only a few parts



	VIGOR No.	Designation	X	EAN 4047728+
①	V3423	Mounting pipe	1	034234
②	V3425	Pressure pipe	1	034258
③	V3424	Thrust washer	1	034241



V3631, EAN 4047728036313

Transverse control arm bushing set, front VW T5

- Changing the rear wishbone bushing on the front wishbone
- VW T5, model years 2004 →
- Working time: approx. 15 minutes

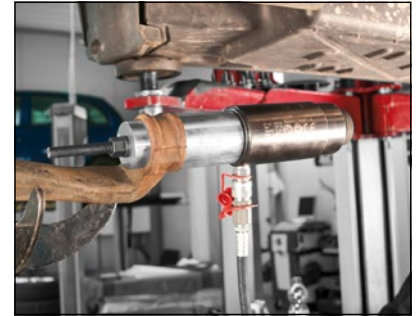

	VIGOR No.	Designation	mm	X	EAN 4047728+
①	V3136	Drawbar M14	250	1	031363
②	V3641	Pressure plate*	-	1	036412
③	V3642	Pressure sleeve	-	1	036429
④	V3137	Flange nut M14	-	2	031370
⑤	V3135	Adapter M22-M14	-	1	031356

* Inside diameter 23 mm suitable for M 22 spindle



V2917, EAN 4047728029179

Bushing set for control arm, rear MERCEDES-BENZ

- Changing the rear/bottom bushings of the longitudinal control arm
- For MERCEDES-BENZ: C-, E-, S-Class



	VIGOR No.	Designation	mm	X	EAN 4047728+
①	V3052	Pressure pipe	-	1	030526
②	V3136	Drawbar M14	250	1	031363
③	V3135	Adapter M22-M14	-	1	031356
④	V3050	Dismounting ring	-	1	030502
⑤	V3051	Mounting bushing	-	1	030519
⑥	V3044	Retaining ring, installation	-	1	030441
⑦	V3137	Flange nut M14	-	2	031370



V4476-1, EAN 4047728060264

Adapter ring for OPEL/VAUXHALL Insignia

- For use with VIGOR safety spring vice V4476
- Additional adapter ring is necessary for work on spring struts of the following vehicles:
- OPEL/VAUXHALL Insignia B model years 2017 → 2019
- Saloon Grand Sport
- Sports Tourer station wagon

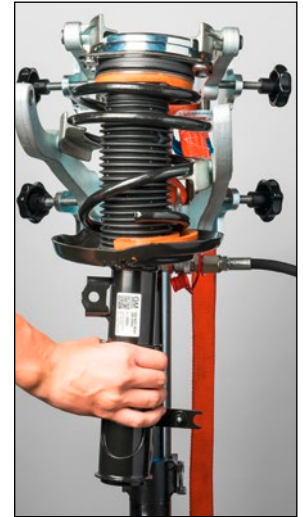
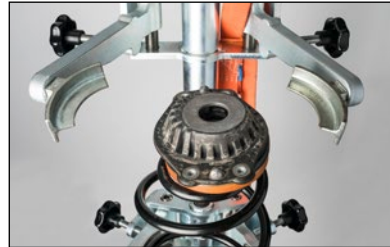

V4352, EAN 4047728043526

Spring plate Ø 70–160 mm

- Individual spring plates (four spring plates are required)
- Can only be used with safety spring vice V4307



V4353, EAN 4047728043533

Spring plate Ø 150–240 mm

- Individual spring plates (four spring plates are required)
- Can only be used with safety spring vice V4307
- 4 spring plates contained in the safety spring vice set V4307



V4354, EAN 4047728043540

Spring plate Ø 150–240 mm with locking element

- Individual spring plates (four spring plates are required)
- Can only be used with safety spring vice V4307
- Especially for CHRYSLER Voyager



V4476N, EAN 4047728068000

Hydraulic safety spring vice including 10 spring plates

- Can be used for almost any spring strut and shock absorber in the field of passenger cars as well as lightweight vans
- Also for MERCEDES-BENZ C-Class (W203), newer BMW and VAG spring struts, with electronic shock absorbers (EDC, DCC)
- By gripping the springs within the spring windings any possible awkward parts on the shock absorber are irrelevant and have no influence on the operation of the safety spring vice
- Can be used both for left and right-hand wound springs
- Precise alignment of spring and shock absorber struts
- Also for separating steering knuckles and spring struts by relieving strain on the spring strut directly on the vehicle without removing the axle shaft, axle alignment possibly no longer required
- Tripod with included rollers enables stowing and mobile work with the safety spring vice – no work bench space needed
- Reverse placement of the supporting frame allows the safety spring vice to be used as an additional hydraulic support and can be used with 2.1 tonnes of force, e.g. for work on control arms or supporting joints
- "Quick pin" mechanism allows quick and easy repositioning of the safety spring vice in order to use the three functions: gripping the spring, separating the steering knuckles from the spring struts and as a hydraulic support

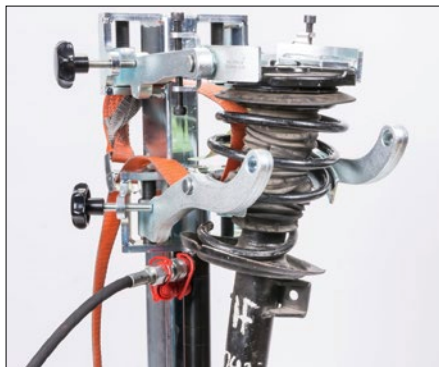

1. Change/tension springs



2. Pre-tension springs directly on the vehicle



3. Aluminium universal support



Safety belt



Quick release lock / Quick pin



2.1 tonnes cylinder



690 mm



Safety spring vice

NEW



16



Height adjustment by turning gripping jaws

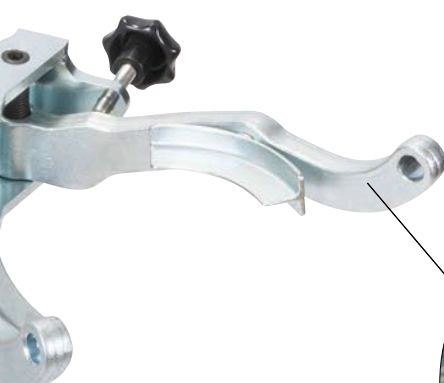
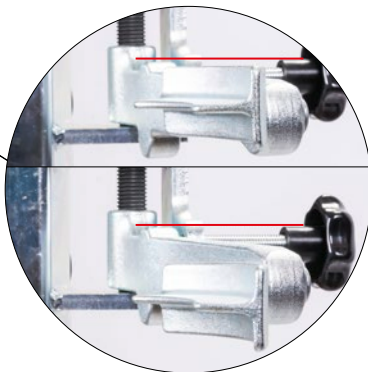

Height adjustment of the arms

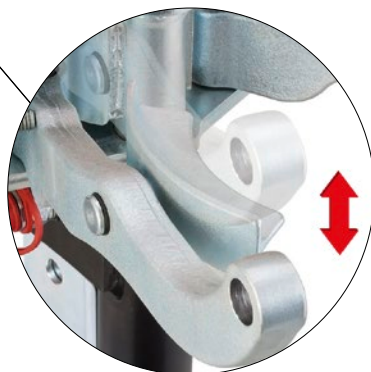

Mobile safety spring vice thanks to castors

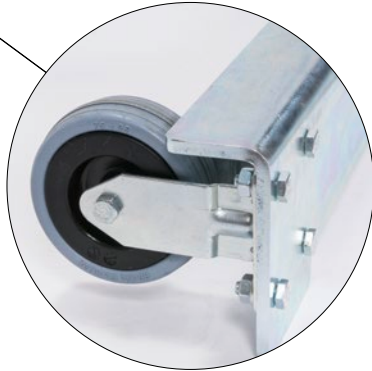

5 – 64 mm

- Sturdy tripod foot with locking element and positioning mechanism for a stable and balanced footing
- When tensioning old springs which are more likely to break, the robust safety belt serves as an additional safety feature
- Including all spring plates (4x V4352, 4x V4353, 2x V4354)
- Hydraulic pump with a working pressure of 700 bar is required for operation (V2846 / V2847)
- Weight: 44 kg
- Capacity: 2.1 tonnes
- Stroke: 430 mm
- Hydraulic universal spring vice V4307
- Spring plate Ø 70–160 mm



V4352



V4353



V4354



VIGOR No.	Designation	EAN 4047728+
V4352	Spring plate Ø 70–160 mm	043526
V4353	Spring plate Ø 150–240 mm	043533
V4354	Spring plate Ø 150–240 mm	043540

V5160, EAN 4047728051606

VIGOR 1000 XL Special

Mobile work bench with specialty tool assortment

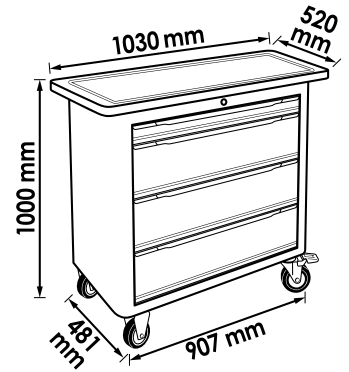
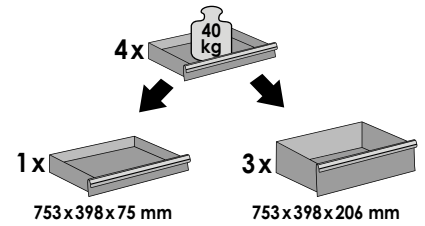
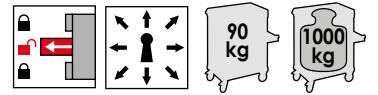

V5058



V5062



V4908



V4921



V4678



V4915



V4906



Drawer 1

Drawer 2

Mobile work benches with specialty tool assortment



V7026, EAN 4047728070263

VIGOR 1000 XL Special

Mobile work bench with specialty tool assortment

NEW

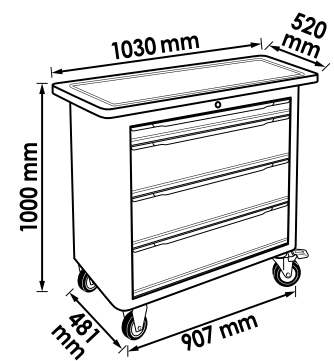
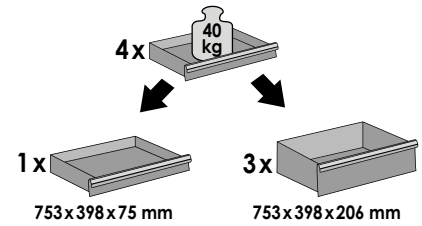
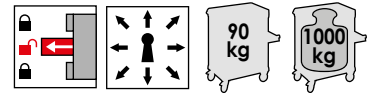

V4678



V4906



V5549-1



V4908



V4921



V4904



V5741N



V5066



V5009



V7026-1, EAN 4047728070386

VIGOR 1000 XL Special

Mobile work bench with specialty tool assortment



NEW

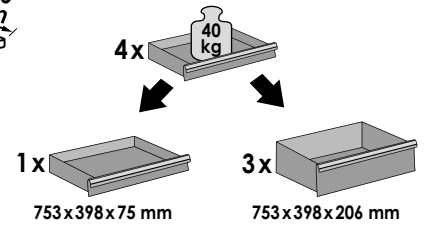
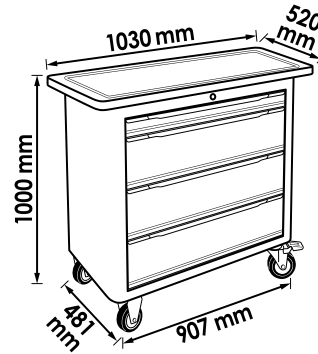
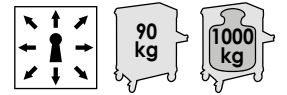

V4678



V4906



V5549-1



V4908



V4921



V4904



V5741N



V5066



V5009



Quick coupling, non-drip

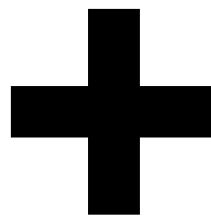

700 bar



0.75 l



2.2 m

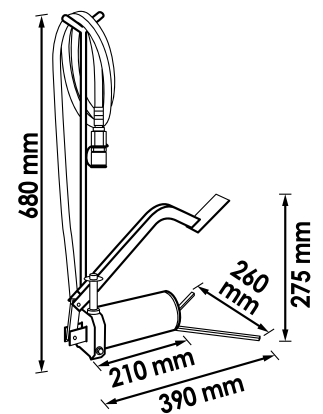

Mobile work benches with specialty tool assortment



V7026-2, EAN 4047728070478

VIGOR 1000 XL Special

Mobile work bench with specialty tool assortment

NEW

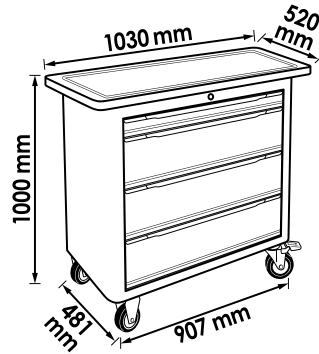

RAL 9005 7005

117

4x 40 kg

1x 753x398x75 mm

3x 753x398x206 mm



V4678



V4906



V5549-1



V4908



V4921



V4904



V5741N



V5066



V5009

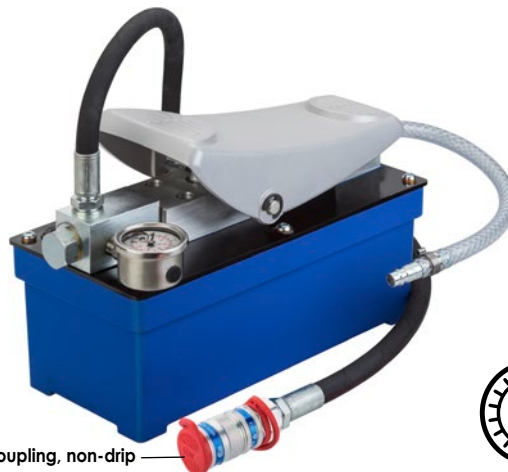
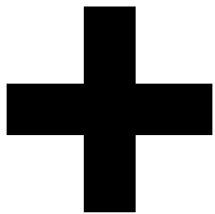

Quick coupling, non-drip

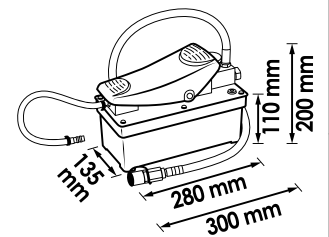

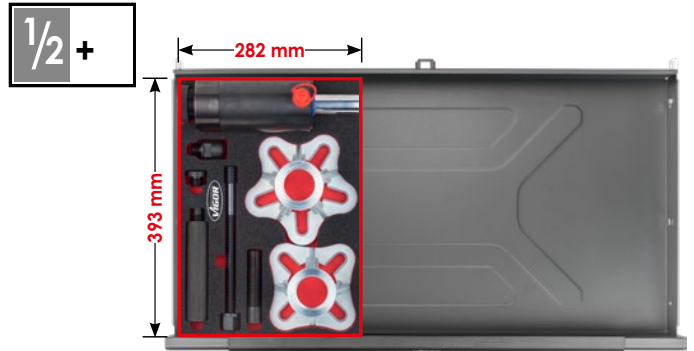

V5064, EAN 4047728050647
 Tractive and compressive hydraulic cylinder 18 tonnes



1/3+
2K

10



V5058-L, EAN 4047728050579
 Soft foam insert, empty



V5058, EAN 4047728050586
 Tractive and compressive hydraulic cylinder 22 tonnes



1/3+
2K

10



V5058-L, EAN 4047728050579
 Soft foam insert, empty



V5060, EAN 4047728050609
 Spindle set, manual



1/3+
2K

10



V5060-L, EAN 4047728050593
 Soft foam insert, empty



V4908, EAN 4047728049085
 Bearing/hub shell set including wheel bearing fixation



1/3+
2K

4



V4908-L, EAN 4047728049078
 Soft foam insert, empty



Special soft foam inserts



V4915, EAN 4047728**049153**
Pressure foot set

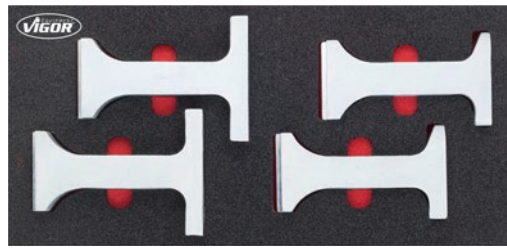

1/3+

2K



V4915-L, EAN 4047728**049146**
Soft foam insert, empty



V5062, EAN 4047728**050623**
Drive shaft tool set

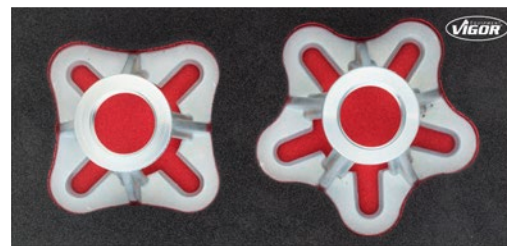

1/3+

2K



V5062-L, EAN 4047728**050616**
Soft foam insert, empty



V4921, EAN 4047728**049214**
Inner bearing ring puller including circlip tool



1/3+

2K



V4921-L, EAN 4047728**049207**
Soft foam insert, empty



V4919, EAN 4047728**049191**
Bushing set longitudinal strut, FORD · Volvo



1/3+

2K



V4919-L, EAN 4047728**049184**
Soft foam insert, empty



V4917, EAN 4047728**049177**
Cardan shaft puller, universal

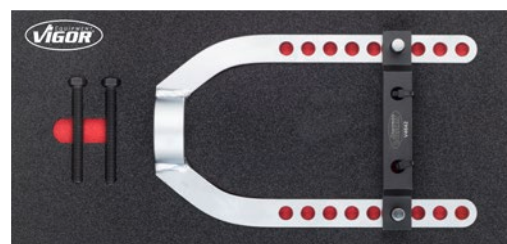

1/3+

2K



V4917-L, EAN 4047728**049160**
Soft foam insert, empty



V4906, EAN 4047728**049061**
Universal wheel hub/bearing installation and removal set



23



V4906-L, EAN 4047728**049054**
 Soft foam insert, empty



V4678, EAN 4047728**046787**
Compact wheel bearing removal / assembly tool set, universal



1/2 +

2K

15



V4676, EAN 4047728**046763**
 Soft foam insert, empty



V5740, EAN 4047728**057400**
Rear axle bearing tool set FORD, MAZDA, Volvo



1/2 +

2K

16



V5740-L, EAN 4047728**057417**
 Soft foam insert, empty



V4904, EAN 4047728**049047**
Set of devices for the removal of drive shafts



1/2 +

2K

12



V4904-L, EAN 4047728**049023**
 Soft foam insert, empty



Special soft foam inserts



V4910, EAN 4047728**049108**
Press frame with open plate with adapter to close the plate



1/2+



V4910-L, EAN 4047728**049092**
Soft foam insert, empty



V4923, EAN 4047728**049238**
Compact wheel bearing removal / assembly tool set, universal



1/2+



V4923-L, EAN 4047728**049221**
Soft foam insert, empty



V5066, EAN 4047728**050661**
Pressure sleeve set



1/2+



V5066-L, EAN 4047728**050654**
Soft foam insert, empty



V4913, EAN 4047728**049139**
Spring plate set

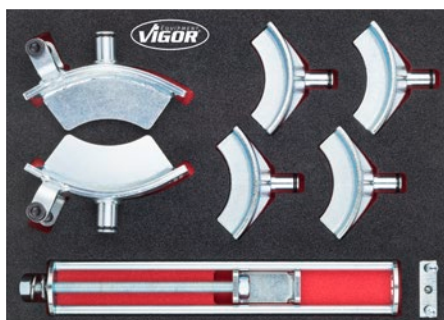

1/2+



V4913-L, EAN 4047728**049115**
Soft foam insert, empty



V2920, EAN 4047728029209

Ball joint puller, universal

- For removing the ball joint pivots from steering arms on vans, trucks and buses

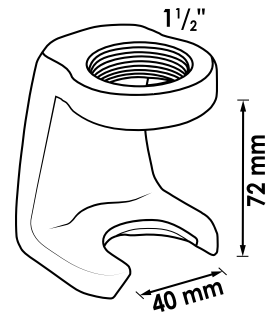

V3678, EAN 4047728036788

Brake disc removal (floating), Volvo, RENAULT, DAF

- Removal of floating brake discs
- Removal of the brake disc by alternately pressing the cylinders
- Two special cylinders and two-way control valves for alternate pressing
- Brake disc removal in just a few minutes

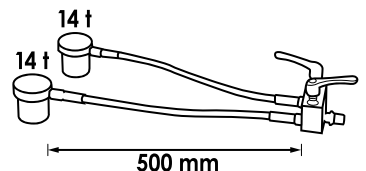
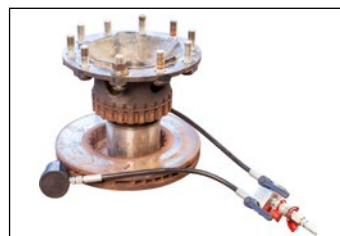
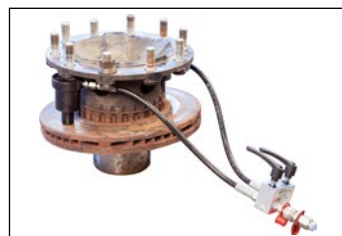

V2858, EAN 4047728028585

Press frame

- Forged press frame for changing supporting joints and ball joints of stabilizers
- Do not load the supporting joints and press frame with more than 16 tonnes
- For e.g.: FORD and MERCEDES-BENZ
- Only together with V2913 · V2915 and V2914



Changing of ball joint or bushing
in approx. 5 – 10 minutes

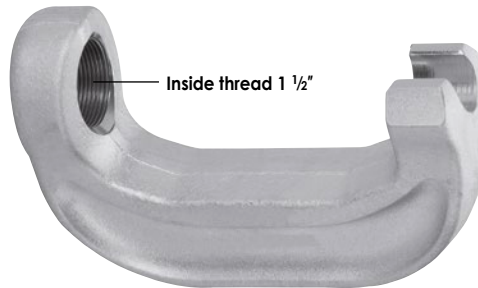

V2943, EAN 4047728029438

Supplementary set for changing the brake anchor bolts

- Quick changing of the brake anchor bolts and its bushings
- Only in conjunction with press frame V2858
- To be used with wheel bolt tool set V2951

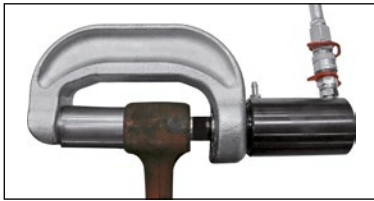

Only in conjunction
with press frame V2858



	VIGOR No.	Designation		EAN 4047728+
①	V3230	Pressure pipe	1	032308
②	V3227	Pressure sleeve (big)	1	032278
③	V3229	Pressure sleeve (small)	1	032292

V2951, EAN 4047728029513

Wheel bolt change tools for trucks, universal

- Changing wheel bolts on trucks and trailers
- Only in conjunction with press frame V2858
- Changing of wheel bolts without a hammer or physical effort
- For DAF · RENAULT · SCANIA · Volvo trucks and most European trailers, e.g. BPW · ROR · SAF · SMB/Frauhof
- Changing of wheel bolts in less than 30 seconds

Only in conjunction with
press frame V2858

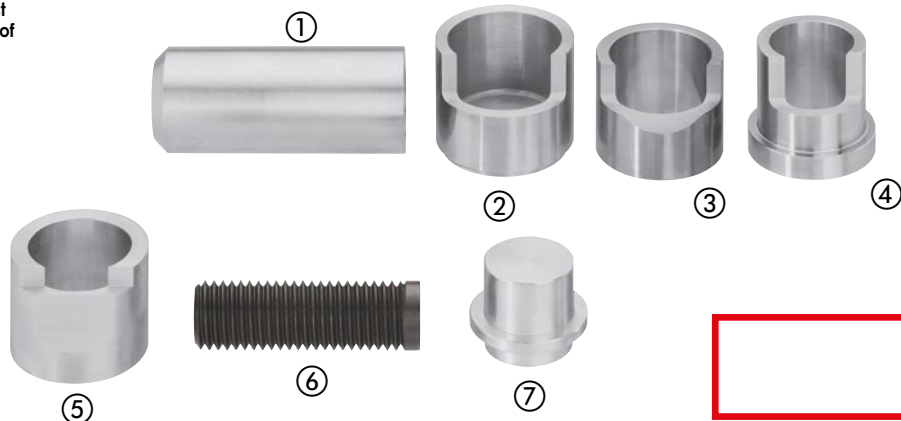

	VIGOR No.	Designation	mm		EAN 4047728+
①	V3246	Mounting bushing	-	1	032469
②	V3242	Dismounting bushing SCANIA	-	1	032421
③	V3239	Dismounting pipe BPW, ROR	-	1	032391
④	V3243	Dismounting pipe small Volvo	-	1	032438

	VIGOR No.	Designation	mm		EAN 4047728+
⑤	V3241	Adjustable thrust rod M24	76	1	032414
⑥	V3245	Counterholder	-	1	032452
⑦	V3244	Dismounting pipe big Volvo, SMB	-	1	032445



V4565, EAN 4047728**045650**

King pin removal tool set 32 tonnes, universal

- For almost all common king pins, also for tapered models
- Unique impact function enables removal with hammer strokes on the cylinder (with mounted impact body) in direction of actuation
- Very effective impact function transmits the vibrations required for successful removal to the material
- Removal of the axle is not necessary
- 32 tonnes-version
- Easy to use, also suitable for buses, where access is often restricted

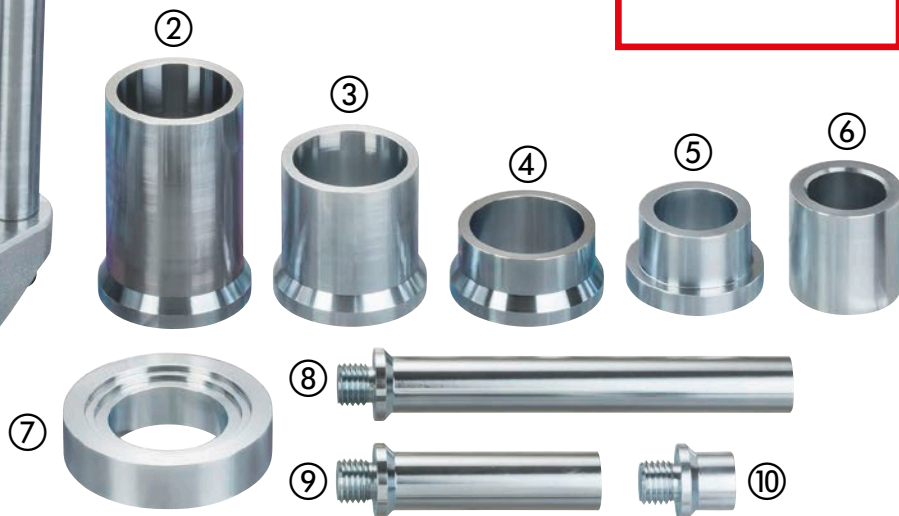
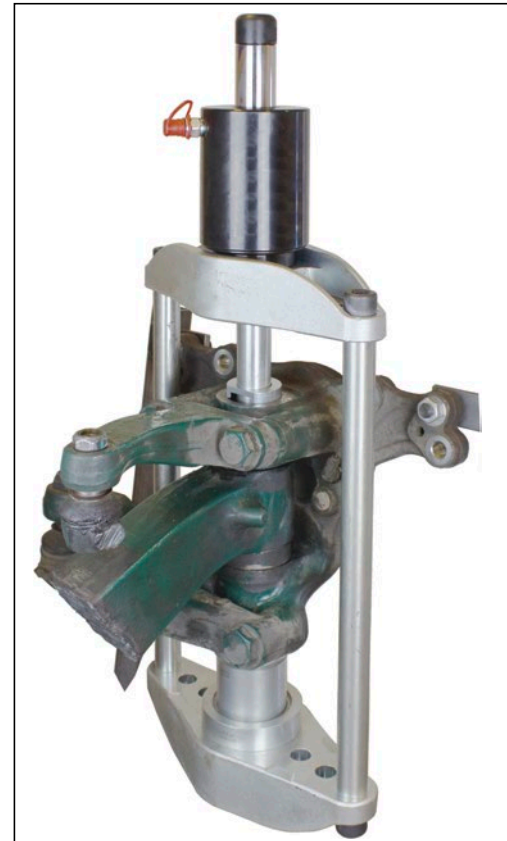

	VIGOR No.	Designation	mm	X	EAN 4047728+		VIGOR No.	Designation	mm	X	EAN 4047728+	
①	V4550	Press frame	-	1	045506		⑥	V4562	Pressure sleeve	-	1	045629
②	V3266	Pressure pipe	130	1	032667		⑦	V4563	Adapter plate	-	1	045636
③	V4564	Pressure pipe 85 mm	85	1	045643		⑧	V3264	Thrust rod Ø 31 mm	250	1	032643
④	V3267	Pressure pipe	42	1	032674		⑨	V3265	Thrust rod Ø 31 mm	140	1	032650
⑤	V4634	Pressure pipe	-	1	046343		⑩	V3232	Thrust rod Ø 31 mm	50	1	032322

V4566, EAN 4047728**045667**

King pin removal tool set 45 tonnes, universal

- For almost all common king pins, also for tapered models
- Unique impact function enables removal with hammer strokes on the cylinder (with mounted impact body) in direction of actuation
- Very effective impact function transmits the vibrations required for successful removal to the material
- Removal of the axle is not necessary
- 45 tonnes-version
- Easy to use, also suitable for buses, where access is often restricted



	VIGOR No.	Designation	mm	X	EAN 4047728+
①	V4550	Press frame	-	1	045506
②	V3266	Pressure pipe	130	1	032667
③	V4564	Pressure pipe 85 mm	85	1	045643
④	V3267	Pressure pipe	42	1	032674
⑤	V4634	Pressure pipe	-	1	046343
⑥	V4562	Pressure sleeve	-	1	045629

	VIGOR No.	Designation	mm	X	EAN 4047728+
⑦	V4563	Adapter plate	-	1	045636
⑧	V4546	Thrust rod M 30, Ø 38 mm	140	1	045469
⑨	V4545	Thrust rod M 30, Ø 38 mm	30	1	045452
⑩	V4549	Thrust rod Ø 38 mm	100	1	045490
⑪	V4548	Thrust rod Ø 38 mm	70	1	045483
⑫	V4547	Thrust rod Ø 38 mm	50	1	045476



V4569, EAN 4047728045698

King pin removal expansion set

- Expansion set for the items V4565 and V4566
- System allows extraction and insertion of king pins on trailers without removing the axle in advance

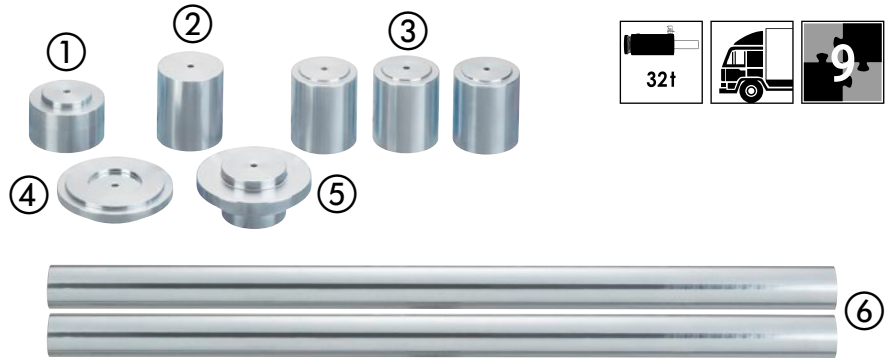

	VIGOR No.	Designation	X	EAN 4047728+
①	V4571	Extension	1	045711
②	V4575	Extension	1	045759
③	V4572	Extension	3	045728
④	V4573	Extension	1	045735
⑤	V4574	Pressure plate	1	045742
⑥	V4570	Support	2	045704



V4605, EAN 4047728046053

King pins removal expansion set MERCEDES-BENZ Actros and Atego

- Expansion set for the items V4565 and V4566
- System allows extraction and insertion of king pins to be carried out directly on the vehicle

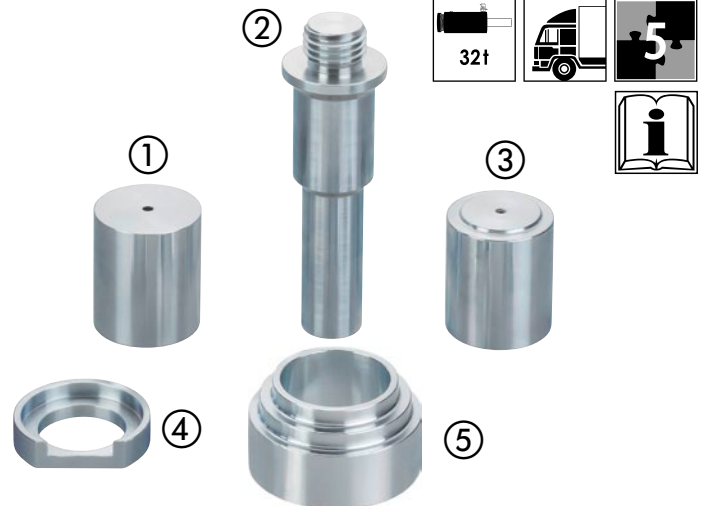

	VIGOR No.	Designation	mm	X	EAN 4047728+
①	V4575	Extension	-	1	045759
②	V4609	Thrust rod M30 length 137 mm Ø 29 mm	137	1	046091
③	V4572	Extension	-	1	045728
④	V4607	Guide ring	-	1	046077
⑤	V4610	Centring thrust block	-	1	046107



V4606, EAN 4047728046060

Steering knuckle removal expansion set MAN TGA · TGX and TGS

- Expansion set for the items V4565 and V4566
- System allows extraction and insertion of king pins to be carried out directly on the vehicle

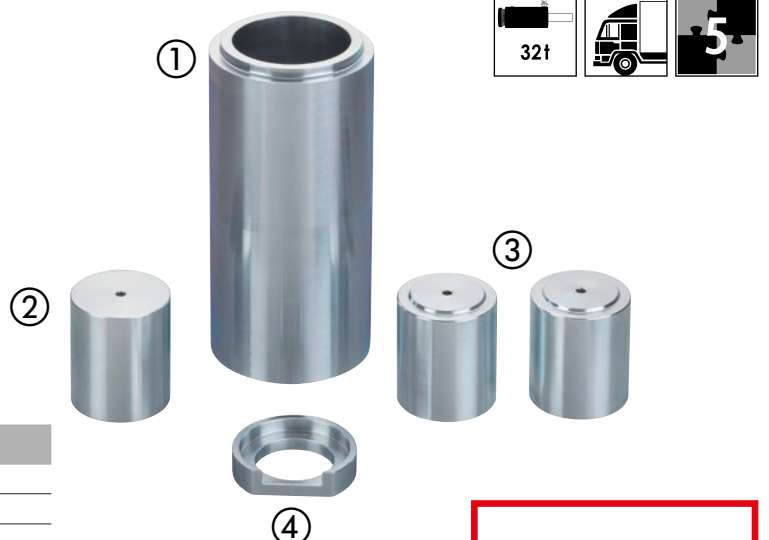

	VIGOR No.	Designation	X	EAN 4047728+
①	V4608	Pressure pipe	1	046084
②	V4575	Extension	1	045759
③	V4572	Extension	1	045728
④	V4607	Guide ring	1	046077





V4554, EAN 4047728045544

Wheel hub puller set for trucks · buses and trailers 32 tonnes

- Wheel hubs of trucks with 8 bolts, 275 mm, or 10 bolts, 335 mm
- Removing wheel hubs with compact bearings, e.g. on SAF axles
- Sturdy construction facilitates the full power of 32 tonnes together with impact force when removing the wheel hub



	VIGOR No.	Designation	mm	X	EAN 4047728+
①	V3263	Screw M22x60 mm, property class: 12.9	-	6	032636
②	V4556	Plate with thread	-	1	045568
③	V3265	Thrust rod Ø 31 mm	140	1	032650
④	V3232	Thrust rod Ø 31 mm	50	1	032322
⑤	V3222	Pressure foot	-	2	032223
⑥	V3231	Pressure plate	-	1	032315
⑦	V3264	Thrust rod Ø 31 mm	250	1	032643

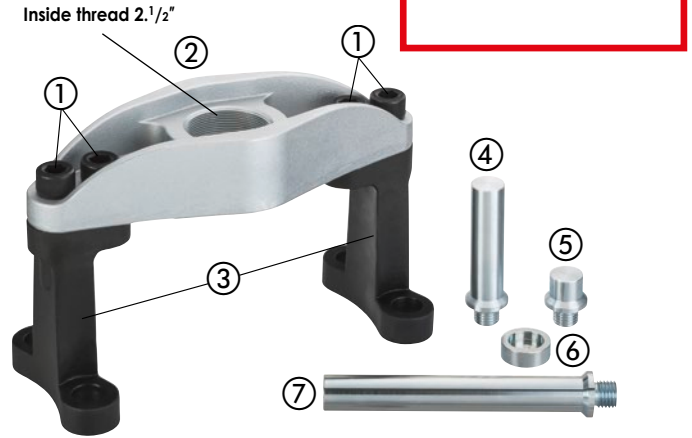

V4555, EAN 4047728045551

Wheel hub puller set for trucks · buses and trailers 45 tonnes

- Wheel hubs of trucks with 8 bolts, 275 mm, or 10 bolts, 335 mm
- Removing wheel hubs with compact bearings, e.g. on SAF axles
- Sturdy construction facilitates the full power of 45 tonnes together with impact force when removing the wheel hub



	VIGOR No.	Designation	mm	X	EAN 4047728+
①	V3263	Screw M22x60 mm, property class: 12.9	-	6	032636
②	V4556	Plate with thread	-	1	045568
③	V3222	Pressure foot	-	2	032223
④	V4546	Thrust rod M 30, Ø 38 mm	140	1	045469
⑤	V4545	Thrust rod M 30, Ø 38 mm	30	1	045452
⑥	V4549	Thrust rod Ø 38 mm	100	1	045490
⑦	V4547	Thrust rod Ø 38 mm	50	1	045476
⑧	V4548	Thrust rod Ø 38 mm	70	1	045483

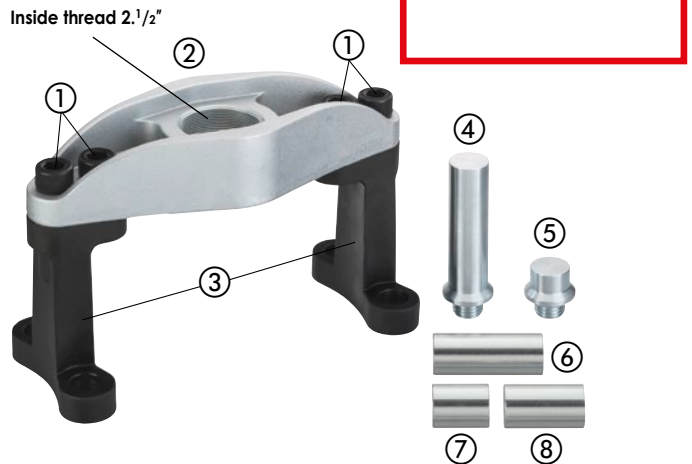

V3634, EAN 4047728036344

Spacer screw M 22

- To be used with wheel hub puller set V2934 on axles with planetary gear in the wheel hub
- Supplied without pictured plate (V2932)
- 4 spacer screws required for use with V2934
- Height: 50 mm



Planetary gear



V3434, EAN 4047728034340

Wheel bearing tool set for SCANIA

- Faster, easier change of the wheel bearing directly on the vehicle
- Only in conjunction with wheel hub puller set V4554
- Striker nut included enables removal using the impact function

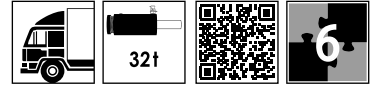

Only in conjunction with wheel hub puller V4554

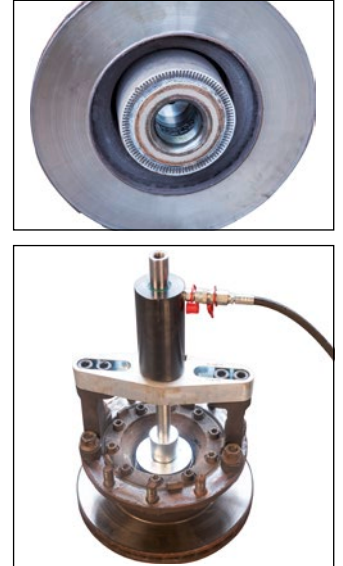
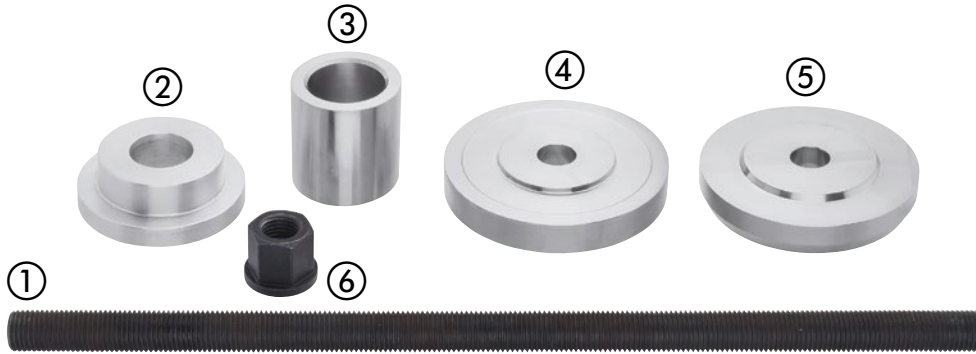

	VIGOR No.	Designation	mm	X	EAN 4047728+
①	V3431	Drawbar M22	500	1	034319
②	V3439	Protective sleeve*	-	1	034395
③	V3440	Pressure sleeve	65	1	034401
④	V3437	Thrust washer Ø 130 mm*	-	1	034371
⑤	V3438	Thrust washer Ø 125 mm*	-	1	034388
⑥	V3132	Flange nut M22	-	1	031325
⑦	V3092	Striker nut M22	-	1	030922

* Inside diameter 23 mm suitable for M 22 spindle

V4499, EAN 4047728044998

Wheel hub puller commercial vehicle, 32 tonnes

- Removal of rusted bearings with outside wheel hubs from straight shafts
- For: Volvo FL · TGS · TGX · MERCEDES-BENZ Atego · Actros · RENAULT Kerax · Magnum · Midlum · Premium
- Can also be used for vehicles with identical construction



	VIGOR No.	Designation	X	EAN 4047728+
①	V3867	Adapter for base component with thread	1	038676
②	V3761	Base component with thread	1	037617
③	V3762	Thrust rod M24	1	037624

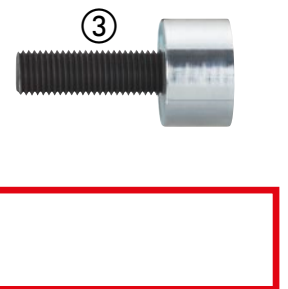
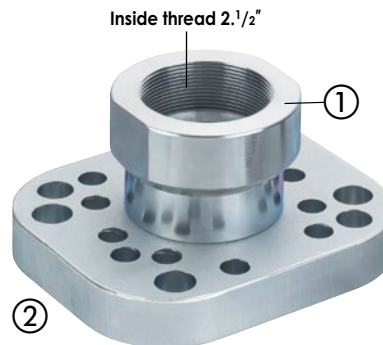

V4500, EAN 4047728045001

Wheel hub puller commercial vehicle, 45 tonnes

- Removal of rusted bearings with outside wheel hubs from straight shafts
- For: Volvo FL · TGS · TGX · MERCEDES-BENZ Atego · Actros · RENAULT Kerax · Magnum · Midlum · Premium
- Can also be used for vehicles with identical construction



	VIGOR No.	Designation	X	EAN 4047728+
①	V3867	Adapter for base component with thread	1	038676
②	V3761	Base component with thread	1	037617
③	V4577	Thrust rod M30	1	045773

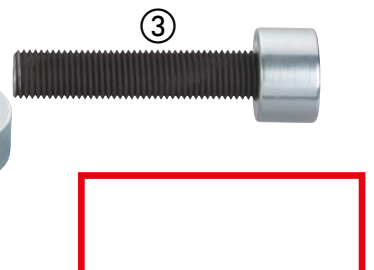
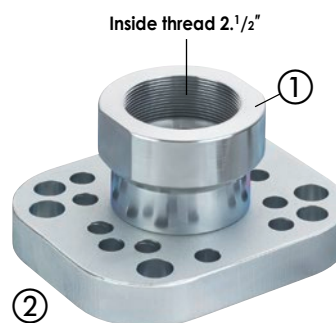

V3750, EAN 4047728**037501**

Wheel hub extractor for low-height trailers

- Removal of 225 mm wheel hub with 10 screws
- Extractor enables loosening of hubs with bearing unit on straight shafts



To be used with threaded plate V4556 (not included), only

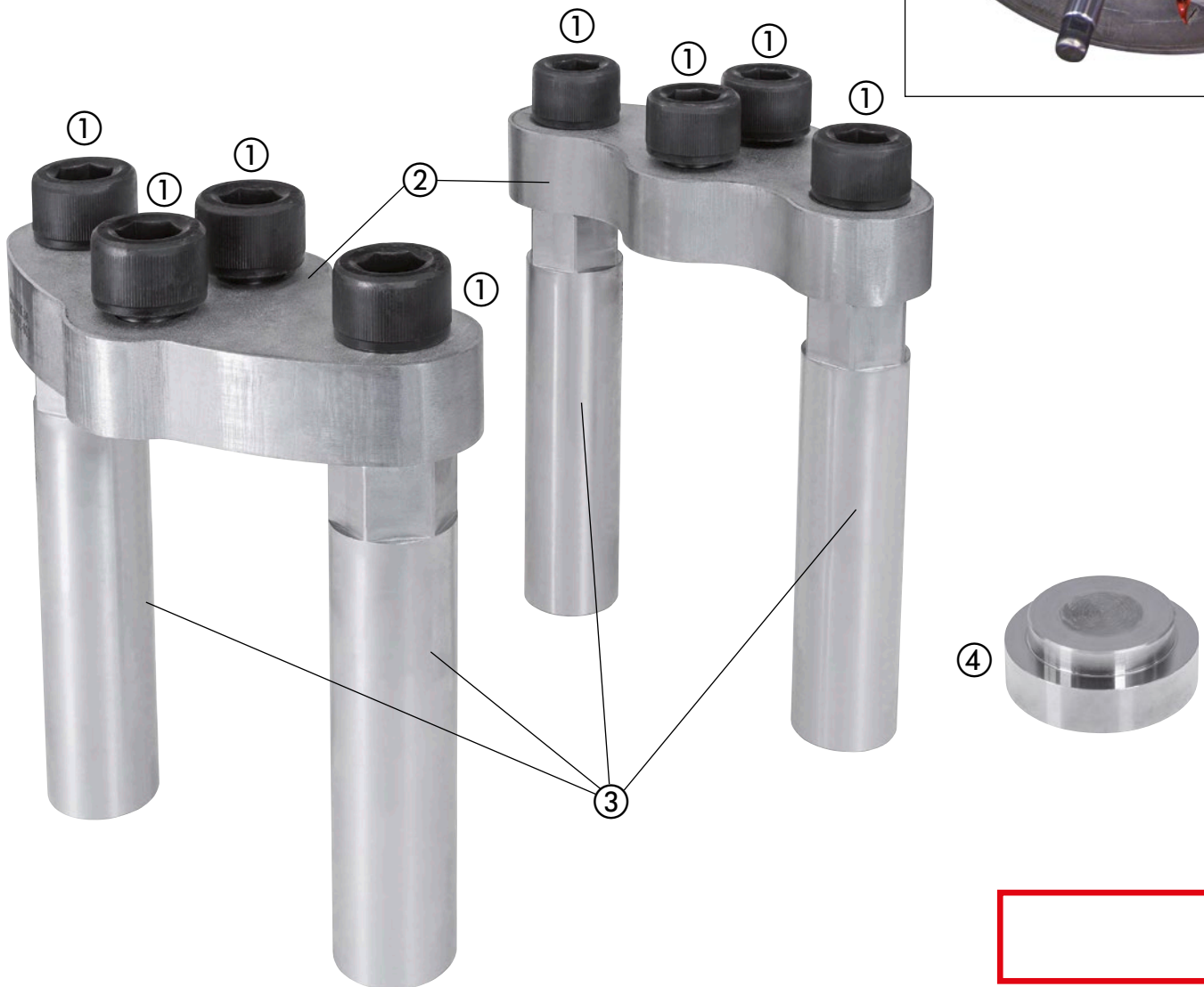

V4556, EAN 4047728**045568**

Plate with thread for V3750 · V4554 · V4555



	VIGOR No.	Designation		EAN 4047728+
①	V3263	Screw M22x60 mm, property class: 12.9	6	032636
②	V3763	Plate	2	037631
③	V3764	Leg	4	037648
④	V3765	Thrust washer SAF Ø 73 mm	1	037655

V4601, EAN 4047728046015

Spring bolt set for SCANIA 32 tonnes

- Removing spring bolts
- To be used with plate V4556 for press frame and 32 tonnes hydraulic cylinder V2874 (not included)
- Use the integrated impact function in the event of rusted bolts (often essential for successful removal)
- Work directly on the vehicle with minimal removal of parts

	VIGOR No.	Designation	mm	X	EAN 4047728+
①	V3262	Press frame	-	1	032629
②	V3259	Thrust washer Ø 54 mm	60	1	032599
③	V3261	Thrust rod Ø 29 mm	115	1	032612
④	V3263	Screw M22x60 mm, property class: 12.9	-	6	032636
⑤	V3260	Thrust rod Ø 29 mm	100	1	032605

V4556, EAN 4047728045568

Plate with thread for V3750 · V4554 · V4555

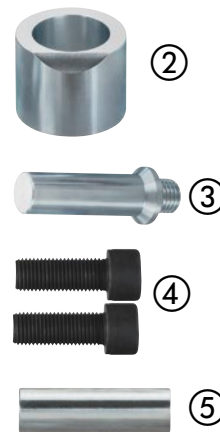
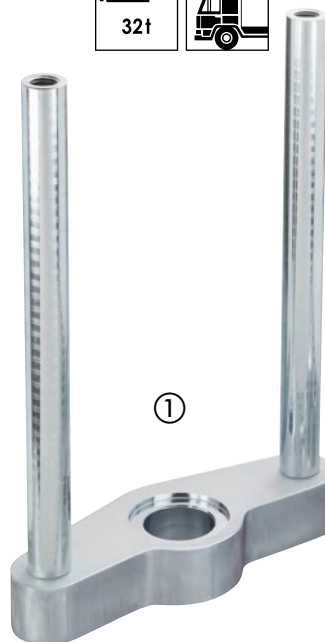
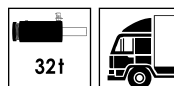

V4602, EAN 4047728046022

Spring bolt set for SCANIA 45 tonnes

- Removing spring bolts
- To be used with plate V4556 for press frame and 45 tonnes hydraulic cylinder V4242 (not included)
- Use the integrated impact function in the event of rusted bolts (often essential for successful removal)
- Work directly on the vehicle with minimal removal of parts

	VIGOR No.	Designation	mm	X	EAN 4047728+
①	V3262	Press frame	-	1	032629
②	V3259	Thrust washer Ø 54 mm	60	1	032599
③	V4609	Thrust rod M30 length 137 mm Ø 29 mm	137	1	046091
④	V3263	Screw M22x60 mm, property class: 12.9	-	6	032636
⑤	V4602-1	Thrust rod, length 64 mm, diameter 29 mm	64	2	046336

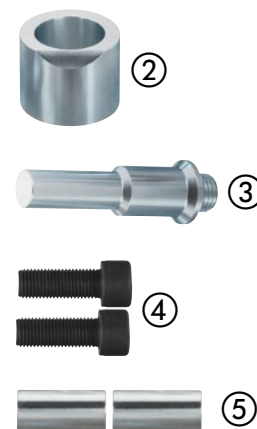
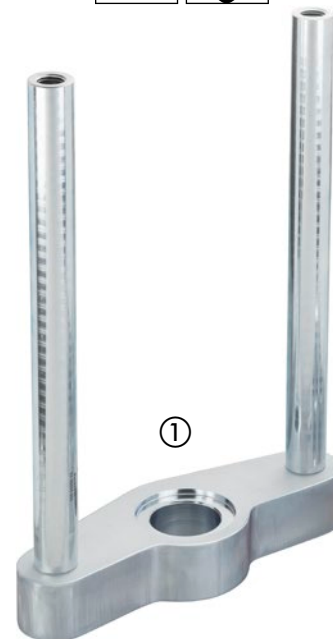
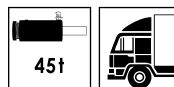

V2937, EAN 4047728029377

Brake adjuster puller

- Removing rusted camshafts of brake adjusters
- Suitable for almost all common lever arms, also Haldex and BPW
- Very compact design guarantees flexible use in areas with restricted access



Inside thread 1 1/2"

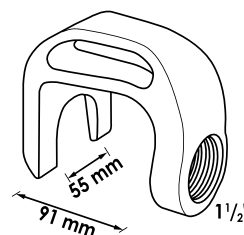
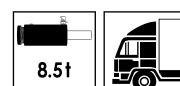

V4635, EAN 4047728046350

Spring bushing set, universal

- Allows changing of spring bushings without unnecessary disassembly
- Tools for removing the joint spring bushings included
- For bushings size 44 to 63 mm
- Easy removal of even rusted bushings due to impact function

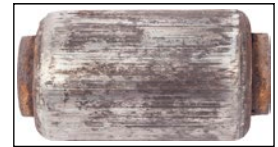
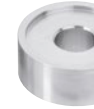

	VIGOR No.	Designation	mm	X	EAN 4047728+
①	V3127	Drawbar M18 / M22	250	1	031271
②	V3126	Flange nut M18	-	1	031264
③	V3266	Pressure pipe	130	1	032667
④	V3267	Pressure pipe	42	1	032674
⑤	V3235	Thrust washer Ø 44 mm*	-	1	032353
⑥	V3236	Thrust washer Ø 50 mm*	-	1	032360
⑦	V3233	Thrust washer Ø 57 mm*	-	1	032339
⑧	V3237	Thrust washer Ø 63 mm*	-	1	032377
⑨	V3234	Thrust washer Ø 63 mm*	-	1	032346

* Inside diameter 23 mm suitable for M 22 spindle

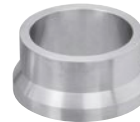

V2936, EAN 4047728029360

Bushing set for SAF axle, 150 mm

- Quick, easy removal / fitting of the large rubber bushings 150 mm on SAF axles



	VIGOR No.	Designation	mm	X	EAN 4047728+
①	V3107	Pressure pipe	-	1	031073
②	V3225	Dismounting/mounting ring Ø 20 mm	-	1	032254
③	V3106	Thrust washer Ø 167 mm*	-	1	031066
④	V3224	Dismounting / mounting washer Ø 137 mm*	-	1	032247
⑤	V3226	Mounting ring Ø 45 mm	-	1	032261
⑥	V3431	Drawbar M22	500	1	034319

* Inside diameter 23 mm suitable for M 22 spindle



⑥



V2942, EAN 4047728029421

Bushing set for drawbars

- Changing bushings with a 32 tonnes hydraulic cylinder V2874 (not included) with impact function directly on the drawbar
- For universal use, especially for VBG bushings and drawbars
- Change bushings without heating or other treatment

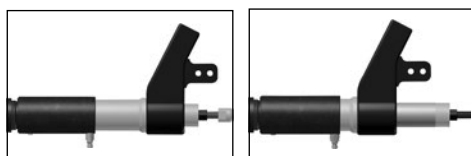

	VIGOR No.	Designation	mm	X	EAN 4047728+
①	V3266	Pressure pipe	130	1	032667
②	V3267	Pressure pipe	42	1	032674
③	V3238	Thrust washer Ø 59 mm*	-	1	032384

* Inside diameter 23 mm suitable for M 22 spindle



①

②

③



V4603, EAN 4047728**046039**

Universal pressure tool set 32 tonnes

- Quick changing of tapered and cylindrical king pins, spring bushings, drawbar bolts as well as large circlips
- Included in the set:
Removal tools for ball joints, brake adjusters, VBG drawbar bolts and tools for removal of wheel hubs, 8.5 tonnes and 32 tonnes hydraulic cylinder with spindle and impact body



	VIGOR No.	Designation	mm	X	EAN 4047728+
①	V3222	Pressure foot	-	2	032223
②	V3263	Screw M22x60 mm, property class: 12.9	-	6	032636
③	V2867	Circlip tool	-	7	028677
④	V2920	Universal ball joint puller	-	1	029209
⑤	V2873	Hydraulic cylinder 8.5 tonnes	-	4	028738
⑥	V2937	Brake adjuster puller	-	1	029377
⑦	V2874	Hydraulic cylinder	-	8	028745
⑧	V3238	Thrust washer Ø 59 mm	-	1	032384

	VIGOR No.	Designation	mm	X	EAN 4047728+
⑨	V3237	Thrust washer Ø 63 mm	-	1	032377
⑩	V3236	Thrust washer Ø 50 mm	-	1	032360
⑪	V3235	Thrust washer Ø 44 mm	-	1	032353
⑫	V3234	Thrust washer Ø 63 mm	-	1	032346
⑬	V3233	Thrust washer Ø 57 mm	-	1	032339
⑭	V3231	Pressure plate	-	1	032315
⑮	V3126	Flange nut M18	-	1	031264
⑯	V3127	Drawbar M18 / M22	250	1	031271
⑰	V4565	Universal set for changing king pins	-	1	045650

V4604, EAN 4047728**046046**

Universal pressure tool set 45 tonnes

- Quick changing of tapered and cylindrical king pins, drawbar bolts as well as large circlips
- Included in the set:
Removal tools for ball joints, brake adjusters, VBG drawbar bolts and tools for removal of wheel hubs, 8.5 tonnes and 45 tonnes hydraulic cylinder with spindle and impact body

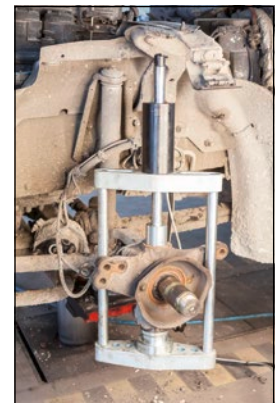
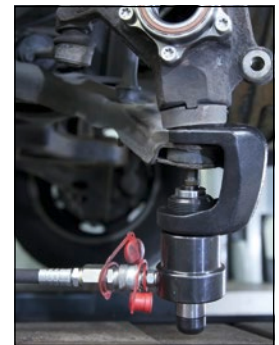

	VIGOR No.	Designation	X	EAN 4047728+
①	V3222	Pressure foot	2	032223
②	V3263	Screw M22x60 mm, property class: 12.9	6	032636
③	V2867	Circlip tool	7	028677
④	V2937	Brake adjuster puller	1	029377
⑤	V2920	Universal ball joint puller	1	029209
⑥	V2873	Hydraulic cylinder 8.5 tonnes	4	028738
⑦	V4229	Tractive and compressive hydraulic cylinder 45 tonnes	7	042291
⑧	V4566	Universal set for changing king pins 45 tonnes	12	045667





Twice a year:
dynamism, strength and quality.



HOT DEALS



NEU

VSS - VIGOR Schrankwand-System
Seite 8-13

Gültig vom 01.09.2019 - 29.02.2020

NEU

GIANT

Seite 24-25

HOT19-2/DE/1 €





www.vigor-equipment.com

Please contact us:



K20/EN/XX/01.11.19/myview HZ-563/PDF

All rights reserved regarding technical modifications. Figures may not always correspond to the original and are thus not binding! We accept no liability for printing errors! Copyright 2020 by VIGOR GmbH

Products available as long as stock lasts!

VIGOR GmbH · Am Langen Siepen 13-15 · D-42857 Remscheid · GERMANY
info@vigor-equipment.com

