

TOOLS THAT MAKE THEIR MARK.



# HOT DEALS 2020/21



Follow us!



VALID FROM 01/09/2020 – 28/02/2021

EINFACH VIGOR.

K1: HOT20-2/EN/NO/9





V6000-3P1

## STARTER KIT

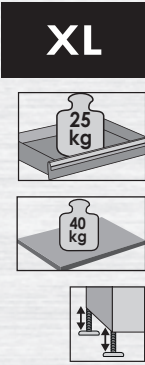
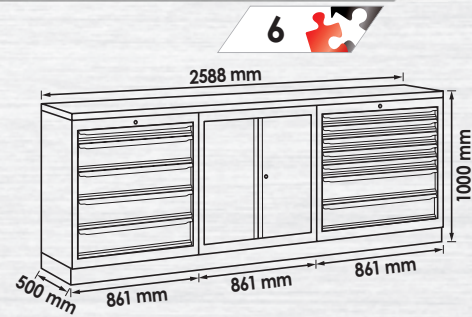

- 3-module combination in wide design
- Available with wooden or stainless steel worktop
- Incl. side veneer

VIGOR No.	Designation	EAN 4047728+	Kr.
V6000-3P1XL	Storage System combination starter kit, wooden	073318	24650,-
V6000-3P1XL-X	Storage System combination starter kit, stainless steel	073271	26975,-

**NEW**

V6000-3P2

## COMPLETE KIT

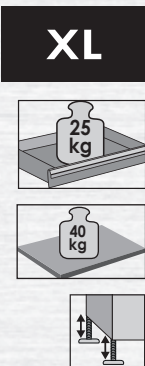
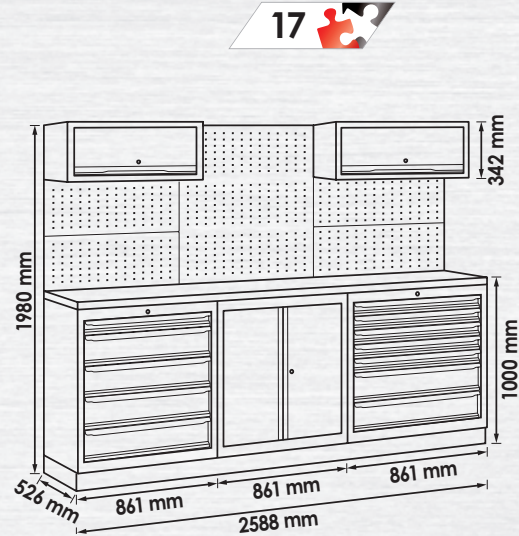

- 3-module combination in wide design with perforated panel structure and wall cabinets
- Available with wooden or stainless steel worktop
- Incl. side veneer

VIGOR No.	Designation	EAN 4047728+	Kr.
V6000-3P2XL	Storage System combination complete kit, wooden	073301	33775,-
V6000-3P2XL-X	Storage System combination complete kit, stainless steel	073295	35975,-

**NEW**



All combinations available with stainless steel and wooden worktops!





V6000-3

# COMPACT KIT

15

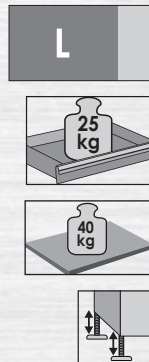
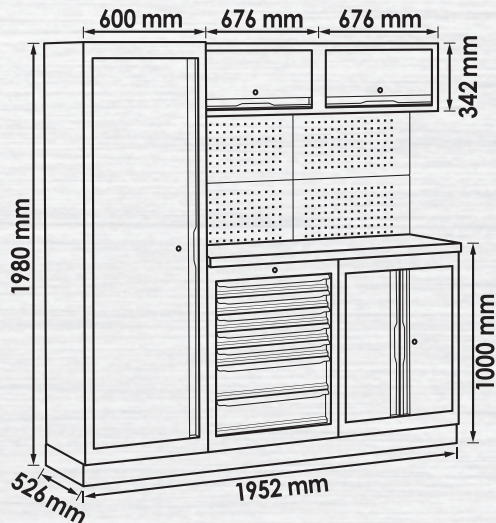

- 3-module combination in slim design with high cabinet, perforated panel structure and wall cabinets
- Available with wooden or stainless steel worktop
- Incl. side veneer

VIGOR No.	Designation	EAN 4047728+	Kr.
V6000-3	Storage System combination compact kit, wooden	048729	25550,-
V6000-3-X	Storage System combination compact kit, stainless steel	073288	27175,-

**NEW**





**V6000-030**

EAN 4047728070140

Drawer lower cabinet  
with 3 drawers

L

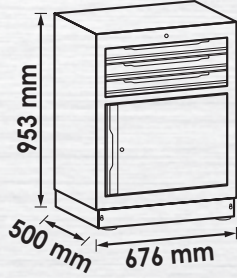
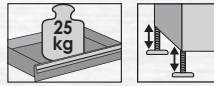

**Kr. 5030**

**V6000-030XL**

EAN 4047728070294

Drawer lower cabinet  
with 3 drawers

XL

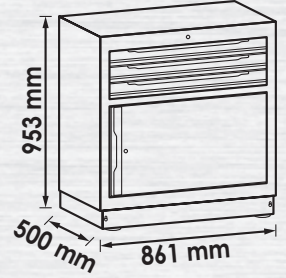
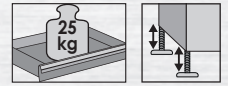

**Kr. 5640**

**V6000-031**

EAN 4047728070157

Drawer lower cabinet  
with 5 drawers

L

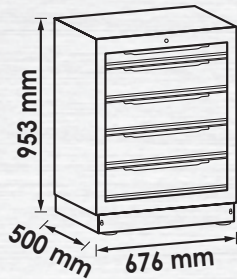
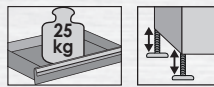

**Kr. 5450**

**V6000-031XL**

EAN 4047728070300

Drawer lower cabinet  
with 5 drawers

XL

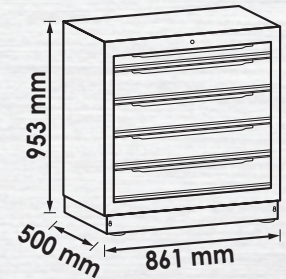
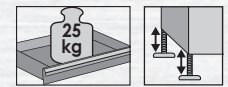

**Kr. 6660**

**V6000-01**

EAN 4047728048248

Drawer lower cabinet  
with 7 drawers

L

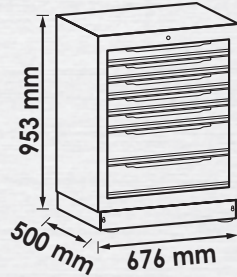
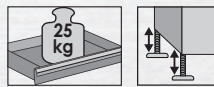

**Kr. 5825**

**V6000-01XL**

EAN 4047728070317

Drawer lower cabinet  
with 7 drawers

XL

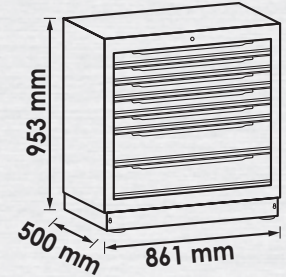
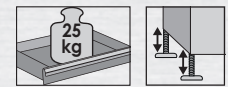

**Kr. 6990**



V6000-032

EAN 4047728070171

Drawer lower cabinet  
with 8 drawers

L

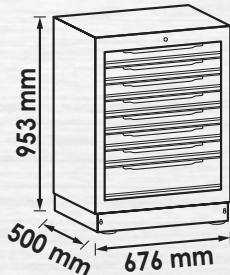

Kr. 6150

V6000-032XL

EAN 4047728070324

Drawer lower cabinet  
with 8 drawers

XL

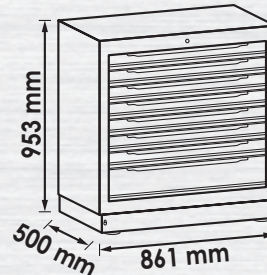
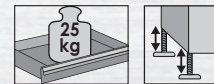

Kr. 7350

V6000-02

EAN 4047728048255

Lower cabinet with  
double-hinged door

- Incl. 1 storage shelf

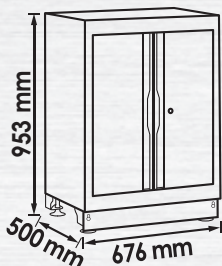

Kr. 4350

V6000-02XL

EAN 4047728070355

Lower cabinet with  
double-hinged door

- Incl. 1 storage shelf

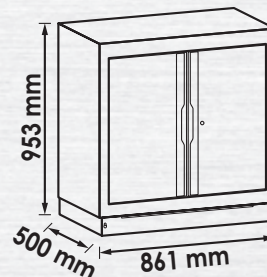

Kr. 4990

V6000-033

EAN 4047728070195

Lower cabinet  
for waste

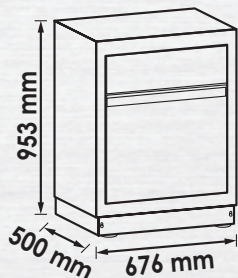

Kr. 4990

V6000-033XL

EAN 4047728070331

Lower cabinet  
for waste

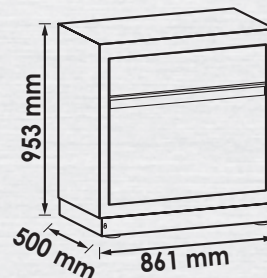

Kr. 5195





## V6000-04

EAN 4047728048279

### Wall cabinet

Optimal storage of tools, containers or motor vehicle parts

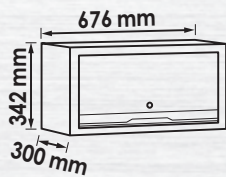

**Kr. 1860**

## V6000-04XL

EAN 4047728070379

### Wall cabinet

Optimal storage of tools, containers or motor vehicle parts

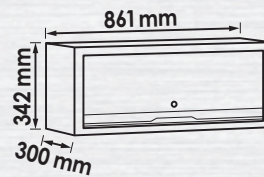

**Kr. 1950**

## V6000-03

EAN 4047728048262

### Cabinet with single-hinged door, high

Optimal storage of tool boxes, work clothes, containers or motor vehicle parts

- Can be extended with additional storage shelves V6000-017
- Incl. 2 storage shelves

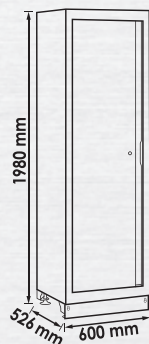

**Kr. 6590**

## V6000-03XL

EAN 4047728070362

### Cabinet with double-hinged door, high

Optimal storage of tool boxes, work clothes, containers or motor vehicle parts

- Can be extended with additional storage shelves V6000-017XL
- Incl. 2 storage shelves

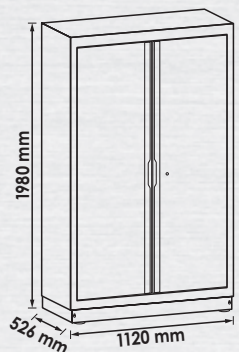

**Kr. 9650**



V6000-019

EAN 4047728063883

Tool trolley for Storage System with 7 drawers

Space-saving storage of the tool trolley under the Storage System worktop  
• Especially for the VIGOR Storage System

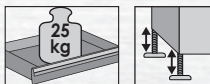

4 swivel castors and 2 front handles!

Kr. 6190

V6000-019XL

EAN 4047728070683

Tool trolley for Storage System with 7 drawers

Space-saving storage of the tool trolley under the Storage System worktop  
• Especially for the VIGOR Storage System

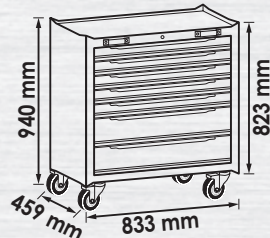
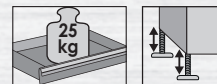

4 swivel castors and 2 front handles!

Kr. 6550

V6000-011

EAN 4047728054904

Corner base cabinet

Corner extension for additional lower cabinet modules

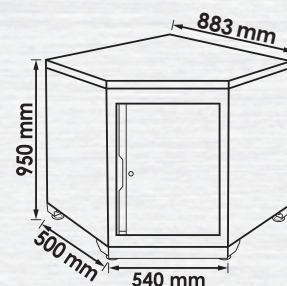

Kr. 7990





# Worktops

The right choice for any combination!

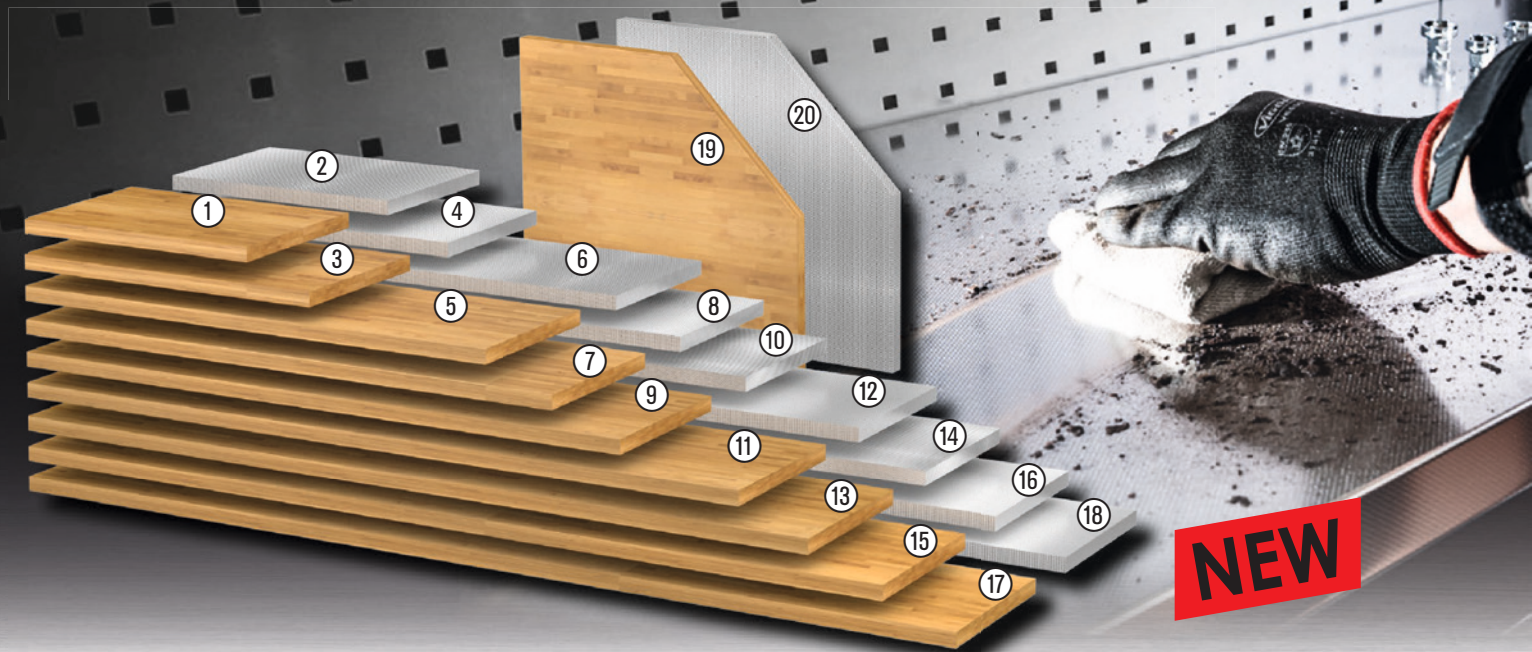

	VIGOR No.	Designation	Dimensions mm	EAN 4047728+	Kr.
①	<b>V6000-0676</b>	Wooden worktop, small	676 x 500 x 40	073028	<b>1895,-</b>
②	<b>V6000-0676-X</b>	Stainless steel worktop, small	676 x 500 x 40	073035	<b>2540,-</b>
③	<b>V6000-0861</b>	Wooden worktop, small	861 x 500 x 40	073042	<b>2160,-</b>
④	<b>V6000-0861-X</b>	Stainless steel worktop, small	861 x 500 x 40	073059	<b>3050,-</b>
⑤	<b>V6000-01357</b>	Wooden worktop, medium	1357 x 500 x 40	073066	<b>3180,-</b>
⑥	<b>V6000-01357-X</b>	Stainless steel worktop, medium	1357 x 500 x 40	073073	<b>4460,-</b>
⑦	<b>V6000-01541</b>	Wooden worktop combined, medium	1541 x 500 x 40	073141	<b>3960,-</b>
⑧	<b>V6000-01541-X</b>	Stainless steel worktop combined, medium	1541 x 500 x 40	073158	<b>4840,-</b>
⑨	<b>V6000-01725</b>	Wooden worktop, medium	1725 x 500 x 40	073080	<b>3825,-</b>
⑩	<b>V6000-01725-X</b>	Stainless steel worktop, medium	1725 x 500 x 40	073097	<b>4990,-</b>
⑪	<b>V6000-02036</b>	Wooden worktop, large	2036 x 500 x 40	073103	<b>4460,-</b>
⑫	<b>V6000-02036-X</b>	Stainless steel worktop, large	2036 x 500 x 40	073110	<b>6380,-</b>
⑬	<b>V6000-02215</b>	Wooden worktop combined, large	2215 x 500 x 40	073165	<b>5090,-</b>
⑭	<b>V6000-02215-X</b>	Stainless steel worktop combined, large	2215 x 500 x 40	073172	<b>6380,-</b>
⑮	<b>V6000-02404</b>	Wooden worktop combined, large	2404 x 500 x 40	073189	<b>5485,-</b>
⑯	<b>V6000-02404-X</b>	Stainless steel worktop combined, large	2404 x 500 x 40	073196	<b>6995,-</b>
⑰	<b>V6000-02588</b>	Wooden worktop, large	2588 x 500 x 40	073127	<b>5480,-</b>
⑱	<b>V6000-02588-X</b>	Stainless steel worktop, large	2588 x 500 x 40	073134	<b>7650,-</b>
⑲	<b>V6000-0860</b>	Wooden worktop, pentagonal	883 x 500 x 40	073202	<b>3715,-</b>
⑳	<b>V6000-0860-X</b>	Stainless steel worktop, pentagonal	883 x 500 x 40	073219	<b>5570,-</b>



**Small - 1 cabinet**

676 mm | 861 mm



① ②

V6000-0676 • V6000-0676-X

**Medium - 2 cabinets**

1357 mm | 1725 mm | 1541 mm



⑤ ⑥

V6000-01357 • V6000-01357-X

**Large - 3 cabinets**

2036 mm | 2588 mm | 2215 mm | 2404 mm



⑪ ⑫

V6000-02036 • V6000-02036-X

Slim design



③ ④

V6000-0861 • V6000-0861-X



⑨ ⑩

V6000-01725 • V6000-01725-X



⑰ ⑱

V6000-02588 • V6000-02588-X

Wide design

**STAINLESS STEEL  
WORKTOPS**

- Extra stable and insensitive material
- Incomparable design and noble down to the smallest detail
- Structured and particularly scratch-resistant surface
- Easy-care and high-gloss, easy to clean in no time



⑦ ⑧

V6000-01541 • V6000-01541-X



⑬ ⑭

V6000-02215 • V6000-02215-X

Combined



⑮ ⑯

V6000-02404 • V6000-02404-X



# Accessories

Slim design  
676 mm

① **V6000-05**  **Kr. 590**  
EAN 4047728048286  
Set of perforated panels,  
676 x 342 mm

② **V6000-05S** **Kr. 3630**  
EAN 4047728073011  
Perforated panel,  
676 x 301 mm **NEW**

③ **V6000-05SXL** **Kr. 725**  
EAN 4047728073004  
Perforated panel,  
676 x 985 mm **NEW**

Wide design  
861 mm

④ **V6000-015**  **Kr. 815**  
EAN 4047728055260  
Set of perforated panels,  
861 x 342 mm

⑤ **V6000-015S** **Kr. 450**  
EAN 4047728072991  
Perforated panel,  
861 x 301 mm **NEW**

⑥ **V6000-015SXL** **Kr. 915**  
EAN 4047728072984  
Perforated panel,  
861 x 985 mm **NEW**

⑦ **V6000-07**  **Kr. 590**  
EAN 4047728048309  
Set of lateral struts

⑧ **V6000-06** **Kr. 350**  
EAN 4047728048293  
Centre strut

⑨ **V6000-010** **Kr. 135**  
EAN 4047728048439  
Side panel for lower cabinets,  
500 mm

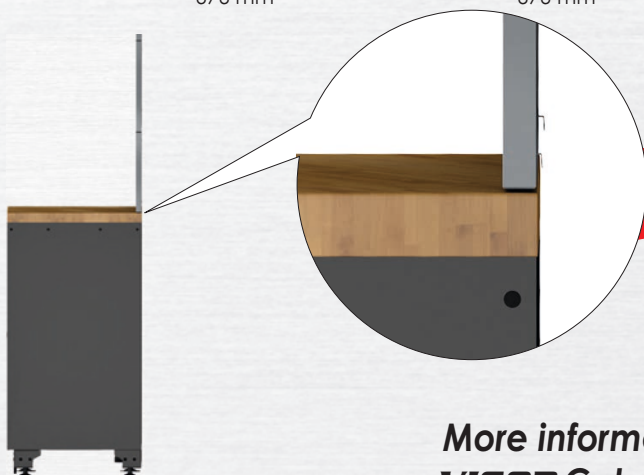
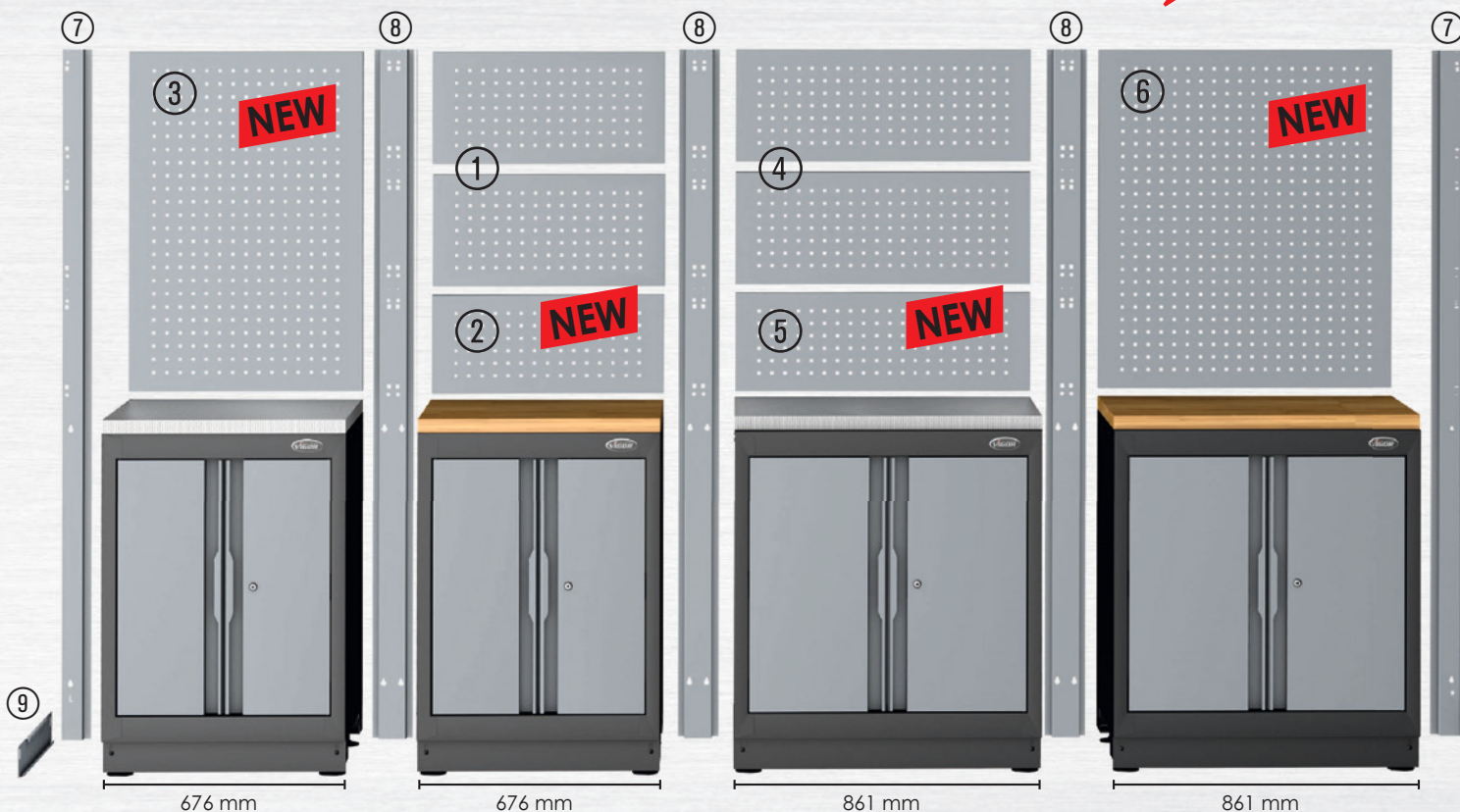

**New design**

⑧ **V6000-040/4**  **Kr. 100**  
EAN 4047728070645  
**Set of connection plates**  
• Additional rear stabilisation of the lower cabinets. Only for structure without perforated panels



More information can be found in the  
**VIGOR Catalogue 2020 from page 70!**





The new LED light strips for your VIGOR STORAGE SYSTEM

# Let there be light - with ViGOR!

EAN 4047728072830

**V7283/2**

**Kr. 540**  
excl. VAT



### Set of LED light strips

- Light strip with 1000 lumen, 600 mm
- Incl. On / Off switch
- Incl. adhesive strips for mounting on non-magnetic surfaces
- Incl. mains adapter

**NEW**



**V7283**

EAN 4047728072847

**NEW**

### LED light strip

- Light strip with 1000 lumen, 600 mm
- Incl. adhesive strips for mounting on non-magnetic surfaces

**Kr. 345**  
excl. VAT







**V4481-XD**

EAN 4047728066488

Tool trolley

**VIGOR**  
SERIES **XD**

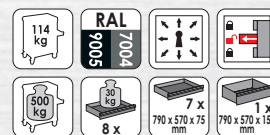
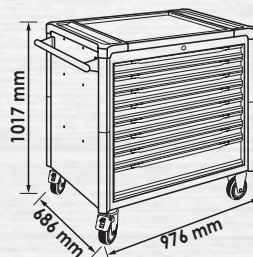

**XD**

Individual price without assortment

**Kr. 13790**

+

**V4481-XD/469**

EAN 4047728068512

**+469**

Tool trolley with 469 expert tools

**V6821**

**V6822**

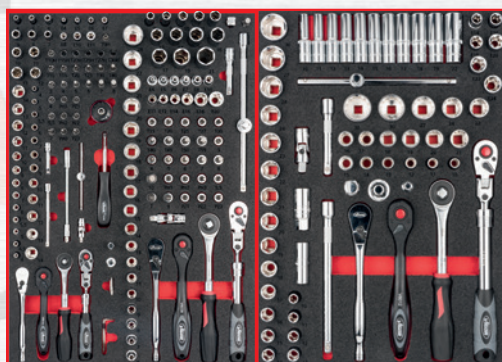

**V6807**

**V6808**

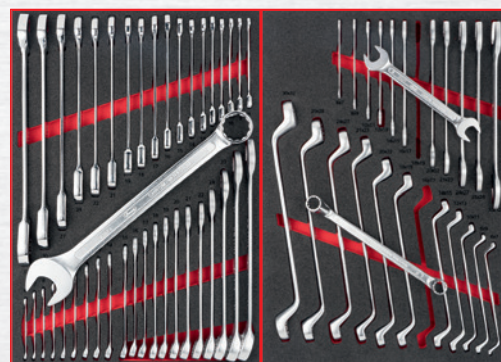

**V6813**

**V6814**



**V6815**

**V6816**



Tool trolley with 469 expert tools

**Kr. 34675**





**V4481-X**

EAN 4047728060721

Tool trolley

**VIGOR SERIES XL**

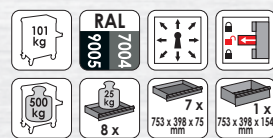
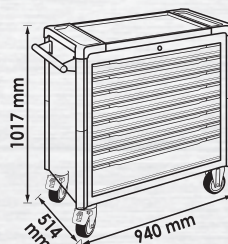

**XL**

Individual price without assortment

**Kr. 11240**



**+**

**V4481-X/375**

EAN 4047728062350

**+375**

Tool trolley with 375 expert tools

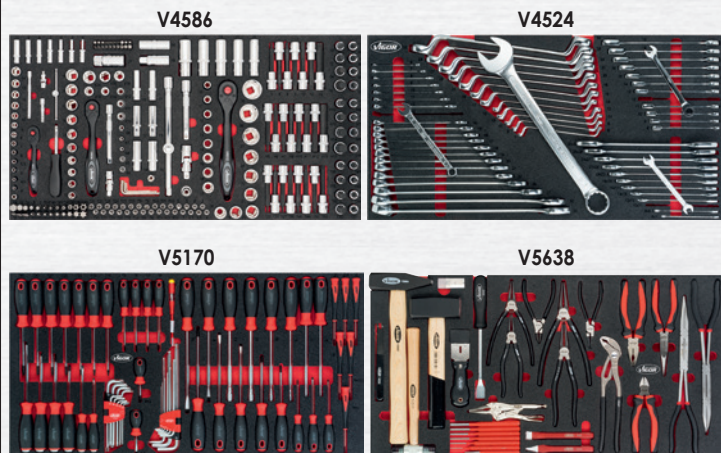

V4586

V4524

V5170

V5638

Tool trolley with 375 expert tools

**Kr. 24880**



**+**

**V4481-X/499**

EAN 4047728062367

**+499**

Tool trolley with 499 expert tools

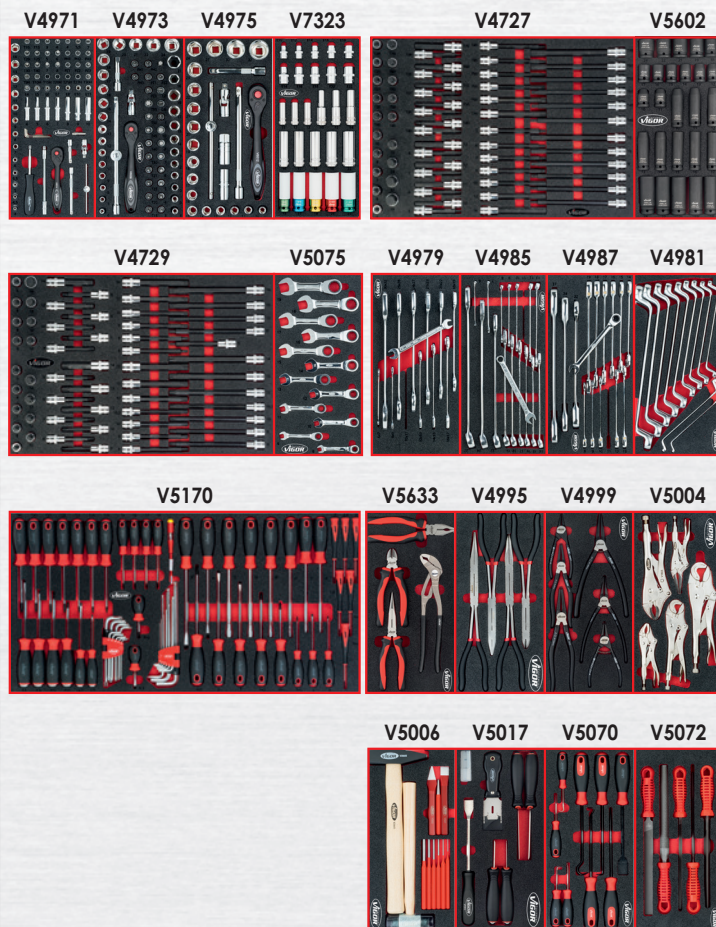

V4971

V4973

V4975

V7323

V4727

V5602

V4729

V5075

V4979

V4985

V4987

V4981

V5170

V5633

V4995

V4999

V5004

V5006

V5017

V5070

V5072

Tool trolley with 499 expert tools

**Kr. 32840**





**V4481**

EAN 4047728044813

Tool trolley

**VIGOR**  
SERIES **XL**

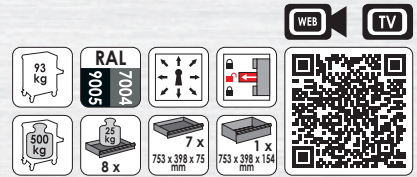
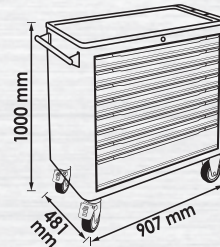

**XL**

Individual price without assortment

**Kr. 9950**



+

**V5434**

EAN 4047728054348

**+499**



Tool trolley with 499 expert tools

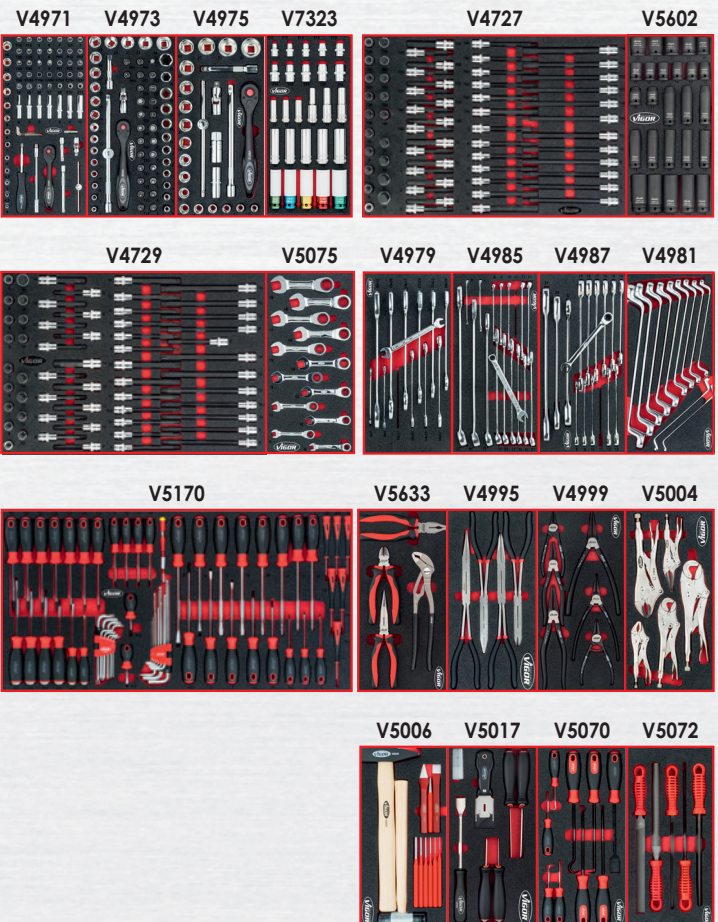

V4971 V4973 V4975 V7323 V4727 V5602

V4729 V5075 V4979 V4985 V4987 V4981

V5170 V5633 V4995 V4999 V5004

V5006 V5017 V5070 V5072

+

**V4542**

EAN 4047728045421

**+375**



Tool trolley with 375 expert tools

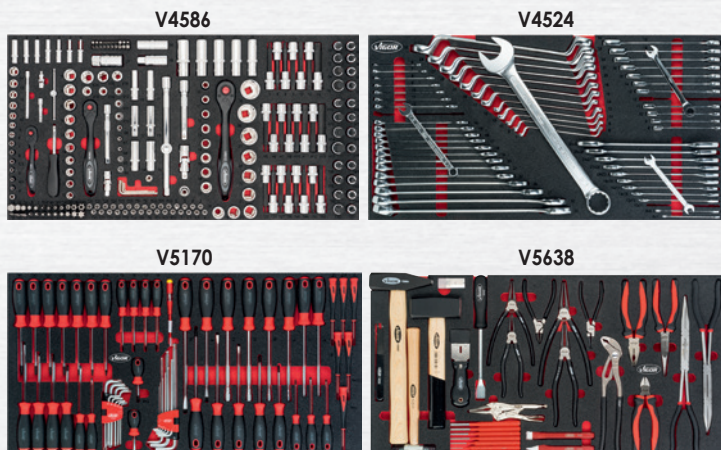

V4586

V4524

V5170

V5638

Tool trolley with 375 expert tools

**Kr. 23350**

Tool trolley with 499 expert tools

**Kr. 32125**





**V1901**

EAN 4047728019019

Tool trolley

**VIGOR**  
SERIES **L**

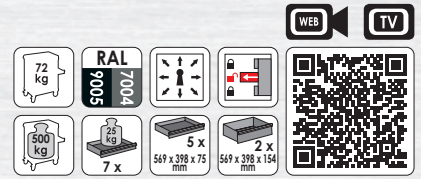
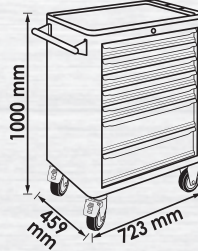

Individual price without assortment

**Kr. 6950**

+

**V4560**

EAN 4047728045605

+344

Tool trolley with 344 expert tools

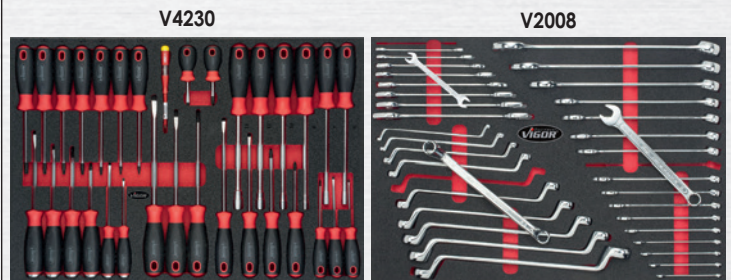
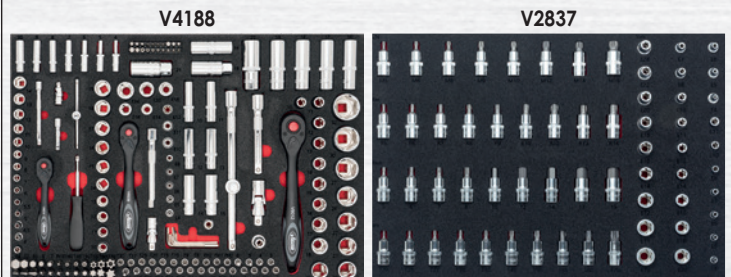

+

**V4219**

EAN 4047728042192

+248

Tool trolley with 248 expert tools

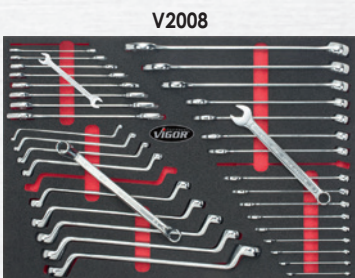
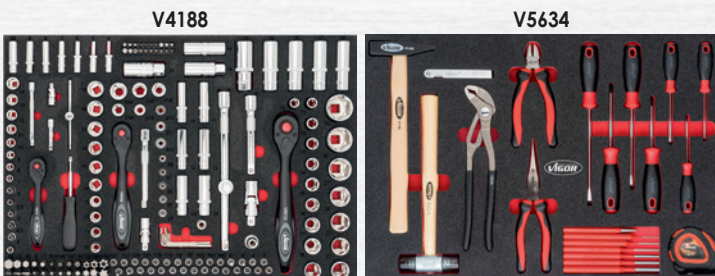

Tool trolley with 248 expert tools

**Kr. 12595**

Tool trolley with 344 expert tools

**Kr. 17495**





**V5489**

EAN 4047728054898

Tool trolley

**VIGOR**  
SERIES **M**

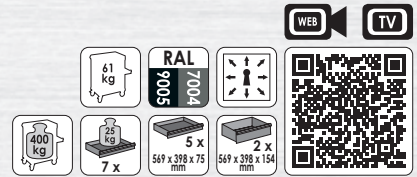
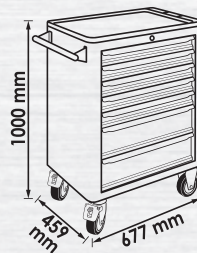

Individual price without assortment

**Kr. 5590**



+

**V2712N**

EAN 4047728055451

+228



Tool trolley with 228 expert tools



Tool trolley with 228 expert tools

**Kr. 9850**

+

**V2379N**

EAN 4047728055444

+164



Tool trolley with 164 expert tools



Tool trolley with 164 expert tools

**Kr. 7850**





**V6394**

EAN 4047728069595

### Impact wrench holder

- Putting an impact wrench down directly on the tool trolley
- Plastic edge protection prevents scratches when inserting the impact wrench
- Suitable for common impact wrenches

**Kr. 245**



The new tool trolley series is equipped with 4 further screw sleeves for installation of the impact wrench holder V6394



**V6398**

EAN 4047728071314

### Laptop holder, rotatable and pivotable

- Pivotable and lockable
- 360° rotation
- Frontal and lateral edging protects the device from falling
- The work surface can be adjusted to the desired inclination
- Four additional holes for passing cables

**Kr. 825**

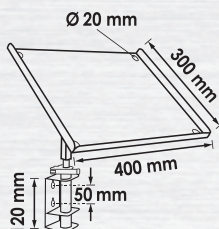

The new tool trolley series is equipped with 4 further screw sleeves for installation of the laptop holder V6398

**V6688**

EAN 4047728070249

Set of separation sheets  
VIGOR Series M and Series L



5

**Kr. 245**

**V6688-XL**

EAN 4047728070096

Set of separation sheets  
VIGOR Series XL

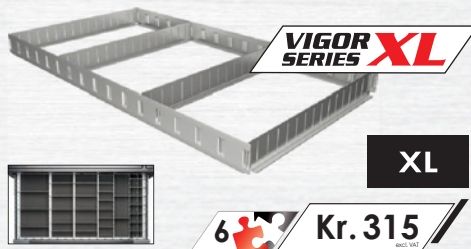

6

**Kr. 315**

**V6688-XD**

EAN 4047728070089

Set of separation sheets  
VIGOR Series XD



6

**Kr. 340**

**V6685**

Set of separation sheets

Compatible with all separation sheet sets and cross members

- Asymmetrical punching allows the separation sheets to be placed side-by-side within a row
- For partitioning within a column

**MADE IN GERMANY**

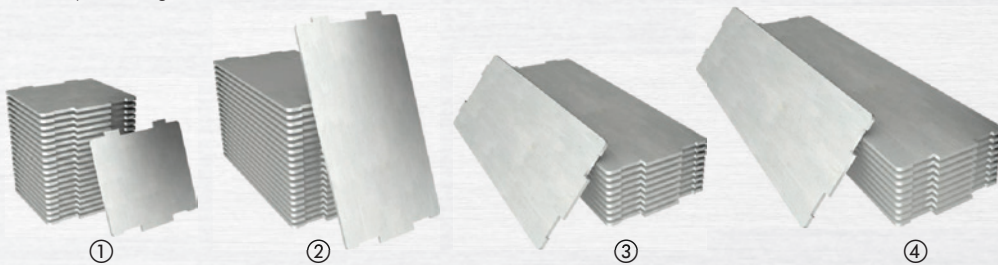

**V6686/5**

EAN 4047728070065

Set of cross members for  
VIGOR Series M, L and XL



5

**Kr. 260**

**V6687/5**

EAN 4047728070072

Set of cross members for  
VIGOR Series XD



5

**Kr. 285**

	VIGOR No.	Designation	mm	X	EAN 4047728+	Kr.
①	<b>V6685-1/20</b>	Separation sheet set, small	45	20	070133	<b>285,-</b>
②	<b>V6685-2/20</b>	Separation sheet set, medium	91	20	070126	<b>335,-</b>
③	<b>V6685-3/10</b>	Separation sheet set, large	137	10	070119	<b>215,-</b>
④	<b>V6685-4/10</b>	Separation sheet set, extra large	183	10	070102	<b>260,-</b>



# VIGOR

## Socket sets

**ONE CASE – ONE HANDLE!  
ONE HANDLE – ONE TOOL!**



**V2414N**

EAN 4047728**056434**



- 4 · 4.5 · 5 · 5.5 · 6 · 7 · 8 · 9 · 10 · 11 · 12 · 13 · 14 mm
- 3 · 4 · 5 · 6 · 7 · 8 mm
- 0.8x4 · 1x5.5 · 1.2x7 mm
- PH 1 · PH 2 · PH 3
- PZ 1 · PZ 2 · PZ 3
- T 10 · T 15 · T 20 · T 25 · T 30 · T 40
- 150 mm

46



**Kr. 460**



**V2305N**

EAN 4047728**056441**



- 6 · 7 · 8 · 9 · 10 · 11 · 12 · 13 · 14 · 15 · 16 · 17 · 18 · 19 · 20 · 21 · 22 · 24 mm
- 8 · 9 · 10 · 11 · 12 · 13 · 14 · 15 · 17 · 19 mm
- 16 · 19 mm
- 3 · 4 · 5 · 6 · 7 · 8 · 10 mm
- 0.8x5.5 · 1x7 · 1.2x8 mm
- PH 1 · PH 2 · PH 3
- PZ 1 · PZ 2 · PZ 3
- T 15 · T 20 · T 25 · T 27 · T 30 · T 40 · T 45 · T 50 · T 55
- 198 mm

61



**Kr. 860**



**V2461N**

EAN 4047728**056472**



- 4 · 4.5 · 5 · 5.5 · 6 · 7 · 8 · 9 · 10 · 11 · 12 · 13 · 14 mm
- 4 · 5 · 6 · 7 · 8 · 9 · 10 mm
- E 4 · E 5 · E 6 · E 7 · E 8
- 3 · 4 · 5 · 6 mm
- 0.8x4 · 1x5 · 1.2x6.5 · 1.2x7 mm
- PH 0 · PH 1 · PH 2
- PZ 0 · PZ 1 · PZ 2
- T 8 · T 9 · T 10 · T 15 · T 20 · T 25 · T 27 · T 30
- T 8 H · T 9 H · T 10 H · T 15 H · T 20 H · T 25 H · T 27 H · T 30 H
- 150 mm
- 10 · 11 · 12 · 13 · 14 · 15 · 16 · 17 · 18 · 19 mm
- 10 · 11 · 12 · 13 · 14 · 15 mm
- E 10 · E 11 · E 12 · E 14 · E 16 · E 18
- 200 mm
- 10 · 11 · 12 · 13 · 14 · 15 · 16 · 17 · 18 · 19 · 20 · 21 · 22 · 24 · 27 · 30 · 32 mm
- 16 · 17 · 18 · 19 · 22 mm
- E 20 · E 24
- 250 mm

172



**Kr. 1450**



**V3277N**

EAN 4047728**056489**



- 8 · 9 · 10 · 11 · 12 · 13 · 14 · 15 · 16 · 17 · 18 · 19 · 22 mm
- 4 · 4.5 · 5 · 5.5 · 6 · 7 · 8 · 9 · 10 · 11 · 12 · 13 · 14 mm
- 4 · 5 · 6 · 7 · 8 · 9 · 10 mm
- 3 · 4 · 5 · 6 mm
- 0.8x4 · 1x5.5 · 1.2x6.5 · 1.2x7 mm
- PH 0 · PH 1 · PH 2
- PZ 0 · PZ 1 · PZ 2
- T 8 · T 9 · T 10 · T 15 · T 20 · T 25 · T 27 · T 30
- T 8 H · T 9 H · T 10 H · T 15 H · T 20 H · T 25 H · T 27 H · T 30 H
- 150 mm
- 10 · 11 · 12 · 13 · 14 · 15 · 16 · 17 · 18 · 19 mm
- 10 · 11 · 12 · 13 · 14 · 15 mm
- 200 mm
- 10 · 11 · 12 · 13 · 14 · 15 · 16 · 17 · 18 · 19 · 20 · 21 · 22 · 24 · 27 · 30 · 32 mm
- 16 · 17 · 18 · 19 · 22 mm
- 250 mm
- T 8 · T 9 · T 10 · T 15 · T 20 · T 25 · T 27 · T 30
- T 8 H · T 9 H · T 10 H · T 15 H · T 20 H · T 25 H · T 27 H · T 30 H

212



**Kr. 2325**





**V7212**

EAN 4047728072120

## Impact socket set, internal serration profile (XZN) and inside hexagon

- Suitable for impact operation
- Output: internal serration profile and inside hexagon
- Surface: burnished and oiled
- For operating common screw joints in VAG vehicles
- Suitable for screw joints in brake carriers, central drive screw joints, shock absorber screw joints or screwed wheel bearing units

**NEW**

Set price:

**Kr. 1175**

VIGOR No.	Size mm	L mm	D mm	L1 mm	EAN 4047728+	Kr.
V7212-M14	14	60	44	30	072137	325,-
V7212-M16	16	60	44	30	072144	325,-
V7212-M18	18	60	44	30	072151	325,-
V7212-H14	14	60	44	30	072168	325,-
V7212-H17	17	60	44	30	072175	325,-
V7212-H19	19	60	44	30	072182	325,-
V7212-H21	21	60	44	30	072199	325,-

20 3/4"



**V7017**

EAN 4047728064705

## Impact screwdriver socket set TORX®

- Suitable for impact operation
- Output: TORX® profile
- Surface: phosphatized



**V7018**

EAN 4047728066846

## Impact screwdriver socket set, internal serration profile (XZN)

- Suitable for impact operation
- Output: internal serration
- Surface: phosphatized



**V7019**

EAN 4047728066372

## Impact screwdriver socket set, inside hexagon

- Suitable for impact operation
- Output: inside hexagon
- Surface: phosphatized



VIGOR No.	Profile	L mm	EAN 4047728+	Kr.
V7017-T30	T30	78	066389	85,-
V7017-T40	T40	78	066396	85,-
V7017-T45	T45	78	066402	85,-
V7017-T50	T50	78	066419	85,-
V7017-T55	T55	78	066426	85,-
V7017-T60	T60	78	066242	85,-
V7017-T70	T70	78	066259	85,-
V7017-T80	T80	78	066266	85,-

Set price:

**Kr. 698**

VIGOR No.	Profile	L mm	EAN 4047728+	Kr.
V7018-M5	M5	78	066273	90,-
V7018-M6	M6	78	066280	90,-
V7018-M8	M8	78	066297	90,-
V7018-M10	M10	78	066303	90,-
V7018-M12	M12	78	066518	90,-
V7018-M14	M14	78	066525	90,-
V7018-M16	M16	78	066532	90,-
V7018-M18	M18	78	066549	90,-

Set price:

**Kr. 698**

VIGOR No.	Profile	L mm	EAN 4047728+	Kr.
V7019-H5	H5	78	066556	85,-
V7019-H6	H6	78	066563	85,-
V7019-H8	H8	78	066570	85,-
V7019-H10	H10	78	066587	85,-
V7019-H12	H12	78	066594	85,-
V7019-H14	H14	78	066600	85,-
V7019-H17	H17	78	066617	85,-
V7019-H19	H19	78	066624	85,-

Set price:

**Kr. 698**



6.3 1/4"

## Fine-tooth reversible ratchets

- Easy to clean
- Closed system
- Robust and service-friendly

6.3 1/4"

Naturally also available in a 10 3/8" and 12 1/2" design.



V4944-XS

**V4944-XS**

EAN 4047728069557

**Kr. 298**

**V4944-S**

EAN 4047728055345

**Kr. 298**

**V4944**

EAN 4047728049443

**Kr. 350**

Extra short design

95 mm



Standard design

150 mm

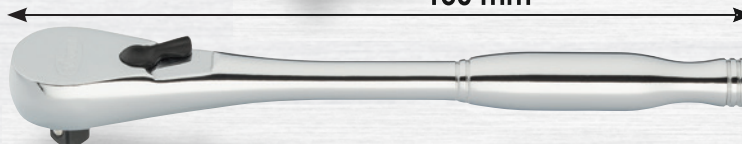

Long design

200 mm



6.3 1/4" 10 3/8" 12 1/2"

### 360° rotary handle reversible ratchet

- Ideally suitable for use in areas with restricted access
- With sliding square for clockwise/anti-clockwise operation
- Standard operation also possible through locking function
- Only clockwise operation

**Loosening and tightening of screw connections only in locked mode!**



Actuator mechanism in the 360° rotary handle

	VIGOR No.	Designation	mm	EAN 4047728+	Kr.
①	<b>V5436</b>	6.3 1/4" Reversible ratchet	136	054362	348,-
②	<b>V6008</b>	10 3/8" Reversible ratchet	237	060080	380,-
③	<b>V5437</b>	12 1/2" Reversible ratchet	288	054379	475,-

6.3 1/4" 10 3/8" 12 1/2"

### Reversible ratchet with hinge joint, extendable

- 180° swivel head with locking mechanism
- With quick-release press-button
- DIN 3122, ISO 3315



**V6614** 6.3 1/4"



**V6638** 10 3/8"



**V6612** 12 1/2"

	VIGOR No.	Designation	mm	EAN 4047728+	Kr.
①	<b>V6614</b>	6.3 1/4" Reversible ratchet	175-225	066440	325,-
②	<b>V6638</b>	10 3/8" Reversible ratchet	250-350	066457	380,-
③	<b>V6612</b>	12 1/2" Reversible ratchet	350-490	066464	530,-



**V1031**

EAN 4047728010313

12

**Kr. 1345**



**Ratcheting combination wrench set, long**

- Tool roll
- 72 teeth
- 5° operating angle

Size 8 · 9 · 10 · 11 · 12 · 13 · 14 · 15 · 16 · 17 · 18 · 19

**V2818**

EAN 4047728028189

12

**Kr. 1798**



180° ratchet head, swivelling

**Ratcheting combination wrench set with hinge**

- Tool roll
- 72 teeth
- 5° operating angle

Size 8 · 9 · 10 · 11 · 12 · 13 · 14 · 15 · 16 · 17 · 18 · 19

**V6752/12**

EAN 4047728068048

12

**Kr. 3495**



**Double joint ratcheting combination wrench set**

- Tool roll
- 72 teeth
- 5° operating angle

Size 8 · 9 · 10 · 11 · 12 · 13 · 14 · 15 · 16 · 17 · 18 · 19

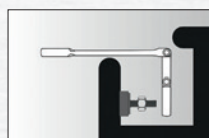
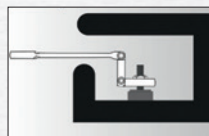

**V6752/5**

EAN 4047728072113

5

**Kr. 1495**



**Double joint ratcheting combination wrench set**

- 72 teeth
- 5° operating angle

Size 8 · 10 · 13 · 17 · 19

Double joint on ratcheting head

**NEW**



**V7099** EAN 4047728**070997**  
Universal jack-knife



**Kr. 98**  
excl. VAT

- Aluminium housing
- Blade lock in open position
- Fast blade change
- Foldable, therefore reduced risk of injury

**V7099-S** EAN 4047728**071000**  
Universal jack-knife, mini



**Kr. 85**  
excl. VAT

**V7099/2** EAN 4047728**071123**  
Universal jack-knife set



**Kr. 175**  
excl. VAT

VIGOR No.	Designation	EAN 4047728+	Kr.
<b>V1446</b>	Trapezoid spare blades for V7099	014465	60,-
<b>V1447</b>	Trapezoid spare blades for V7099-S	070966	35,-

**V7106** EAN 4047728**071062**  
Window pane holder, single

- Loading capacity maximum 50 kg



- Suction cups adapt to smooth, dust-free surfaces
- Release lever for simple operation
- Hold by vacuum build-up of the suction cups
- Sturdy design made of aluminium

**Kr. 175**  
excl. VAT

**V7107** EAN 4047728**071079**  
Window pane holder, double

- Loading capacity maximum 100 kg

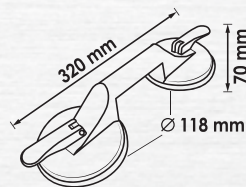

**Kr. 350**  
excl. VAT

**V5485** EAN 4047728**054850**   
Screwdriver set, extra long, flexible

- Working in areas with restricted access
- Extra long, length: 500 mm
- Universal 6.3 mm (1/4") screwdriver bit socket
- Universal 6.3 mm (1/4") square
- 7 mm 6-point output



Only available while stocks last!

**Kr. 298**  
excl. VAT

**V5512** EAN 4047728**055123**  
Gas soldering iron set

- Soldering, melting, shrinking and hot cutting work with seven different adapters
- Device combines three functions into one:  
Soldering iron, maximum temperature: 450 °C  
Burner, maximum temperature: 1300 °C  
Hot air blower, maximum temperature: 600 °C



Level indicator



Stainless steel



**Kr. 545**  
excl. VAT



EAN 4047728072212

**V7221**

**NEW**

**Washing nozzle adjustment tool  
MERCEDES-BENZ**

- For optimal adjustment of window washing system fan nozzles for MERCEDES-BENZ
- Nozzle head profile with fitting accuracy
- Outside hexagon drive: 6 mm
- Suitable for the following models: W204, W207, W212, W218
- Total length: 67 mm



**Kr. 175**  
excl. VAT

**V6952**

EAN 4047728069526

**Mini removal lever set**

- Ideal for replacing the batteries in car keys or working on the dashboard
- Convenient, fine and hence versatile in use



	mm		mm
①	190	④	165
②	185	⑤	170
③	185	⑥	170

**Kr. 185**  
excl. VAT

**V6468**

EAN 4047728064682

**Nozzle adjusting tool  
with magnet**

- Nozzle adjustment of windscreen washing systems
- Additional function as magnetic pick-up tool

*Incl. display for a purchase  
of at least 16 pieces*

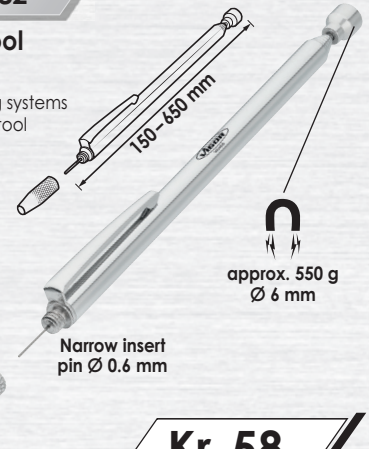

approx. 550 g  
Ø 6 mm

Narrow insert  
pin Ø 0.6 mm

**Kr. 58**  
excl. VAT

**V2338-XL**

EAN 4047728071444

**Mechanic's mat**

- Comfortable work on the ground
- Large lying surface
- Low-impact
- Pliant and heat-retaining foam
- Incl. two handles



**Kr. 360**  
excl. VAT

**V6606**

EAN 4047728066068

**Reusable seat cover**

- Use on seats with or without airbags
- One size fits all, for most passenger cars and common commercial vehicles
- Light nylon, PU-coated
- Water, grease and oil repellent
- Contents: 1 pieces



L 1350 x W 760 mm



**Kr. 160**  
excl. VAT

**V6435**

**Working gloves**

- Light polyester woven gloves with ergonomic fit
- Secure grip and high slip-resistance
- EN 388:2003 (3131A)

*Black PU coating on the palms for good grip!*



VIGOR No.	Size	EAN 4047728+	Kr.
<b>V6435</b>	9	064354	19,-
<b>V6435-XL</b>	10	069984	19,-

**V6605**

EAN 4047728066051

**Fender cover**

- Protection from dents, scratches, oil and dirt
- Does not cover wheels
- Secure hold without magnets on aluminium or plastic car bodies using sand weights
- One size fits all

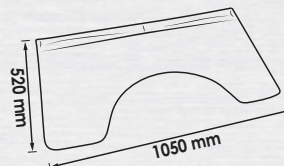

**Kr. 265**  
excl. VAT



## ① **MINI GIANT**

12<sup>5</sup> 1/2"

Max. loosening torque: **1000 Nm**



## ② **ECO GIANT**

12<sup>5</sup> 1/2"

Max. loosening torque: **1200 Nm**



## **GIGA GIANT**

20 3/4"

Max. loosening torque: **1890 Nm**



## ⑤ **QUICK GIANT**



## **SPEED GIANT**

⑥



## ⑧ **FILL GIANT**



## ⑨ **DRILL GIANT**



⑦



### Your **VIGOR GIANTS!**

	VIGOR No.	Designation	EAN 4047728+	Kr.
①	<b>V5671</b>	12 <sup>5</sup> 1/2" Impact wrench, mini, 1000 Nm	056717	<b>1390,-</b>
②	<b>V4800</b>	12 <sup>5</sup> 1/2" Impact wrench, 1200 Nm	047104	<b>1140,-</b>
③	<b>V6899</b>	20 3/4" Impact wrench, 1890 Nm	068994	<b>2975,-</b>
④	<b>V3653</b>	12 <sup>5</sup> 1/2" Impact wrench, 1890 Nm	036535	<b>2475,-</b>
⑤	<b>V5674</b>	Air ratchet	056748	<b>545,-</b>
⑥	<b>V5673</b>	Die grinder, angled	056731	<b>690,-</b>
⑦	<b>V5672</b>	Die grinder, straight design	056724	<b>450,-</b>
⑧	<b>V6905</b>	Tyre inflator	069052	<b>190,-</b>
⑨	<b>V6904</b>	Drilling machine	069045	<b>695,-</b>





Incl. connecting nipple:  
nominal size 7.2

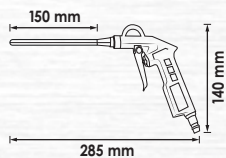

**V7135**

EAN 4047728071352

**Air blow gun, short**

- Air inlet: inside thread 12.91 mm (1/4")
- Working pressure (bar): 6.3 bar
- Hose diameter (recommended): 10 mm
- Sound pressure level (at working pressure): 102 dB(A) Lp A



**V7135-150**

EAN 4047728071369

**Air blow gun, long**

**Kr. 180**  
excl. VAT

**Kr. 210**  
excl. VAT

Long-life aluminium housing | Cold-insulated handle | Suspension device incorporated



**V7143-10**

EAN 4047728071437

**Hose reel, 15 m**

- Reduced risk of accident, as there is no hose lying around
- Compact housing including opening flap for the removal of dirt or to straighten the hose
- Wall holder: 180° swivelling range
- Automatic roll up through guided feed
- Compressed air adapter pre-installed
- Hybrid polymer hose
- Auto stop function
- Impact-resistant polypropylene housing
- Adapted pull-in force
- Maximum working pressure 12 bar
- Including coupler plug and coupler bushing

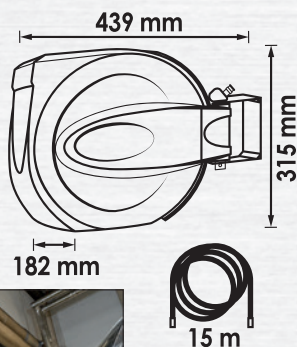

Hose length: 15 m  
Connection element: 1 m

Hose diameter 10 mm,  
7.2 mm coupling

**Kr. 1290**  
excl. VAT

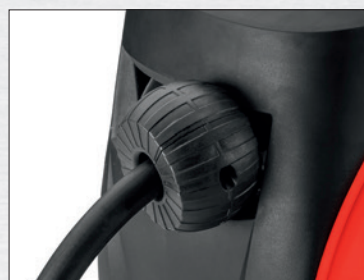



**V7244**

EAN 4047728072441

**Brake line aligning tool Ø 4.75 mm**

- Replaces conventional and imprecise shaping of lines

**NEW**



**Kr. 1175**

**V7259**

EAN 4047728072595

**Brake line bending tool Ø 4.75**

- Easy bending and reshaping of Ø 4.75 mm lines
- The design of the tool allows cables to be bent using 5 different radii
- Exact duplicates can be created by the double shaping per radius

**NEW**

*Bending device for easy duplication of brake lines that keep their shape!*



- mm
- Ø 25
- Ø 35
- Ø 50
- Ø 65
- Ø 80

**Kr. 345**

**V6917**

EAN 4047728069175

**Brake line ratcheting tube cutter Ø 4.75 mm**

- No annoying retightening of the cutting wheel thanks to self-adjustment
- Faster cutting result than conventional line cutters
- Adjustment of the self-adjusting cutting force possible

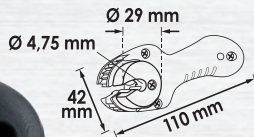

Replacement cutting wheel V6917-REP in the VIGOR Catalogue 2020 on page 228!

**Kr. 315**

**V4416**

EAN 4047728044165

**Tube flaring tool for Ø 4.75 mm**

*Particularly suited for direct use on the vehicle!*

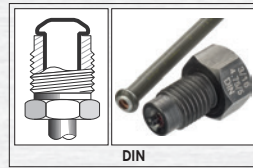

For DIN "F" flares!

**Kr. 565**

EAN 4047728071246

**V7124**

**Kr. 795**

**8**

**Impact screwdriver set**

- Operation of severely corroded screw connections, e.g. centring screws on brake discs
- A hammer strike causes a quarter turn in release direction at the screwdriver head



	VIGOR No.	●	Size mm	←→ mm	EAN 4047728+	Kr.
①	V7124-PH3	+	PH3 x 125	210	071277	125,-
②	V7124-PH2	+	PH2 x 100	185	071260	125,-
③	V7124-PH1	+	PH1 x 75	160	071253	125,-
④	V7124-PZ2	+	PZ2 x 100	185	071291	125,-

	VIGOR No.	●	Size mm	←→ mm	EAN 4047728+	Kr.
⑤	V7124-PZ1	+	PZ1 x 100	185	071284	125,-
⑥	V7124-T30	+	T30 x 125	210	071420	125,-
⑦	V7124-T25	+	T25 x 100	185	071413	125,-
⑧	V7124-T20	+	T20 x 75	160	071307	125,-



EAN 4047728060738

V1711N

Kr. 2055



**Pneumatic brake piston readjusting tool set**

- Efficient and damage-free working on brake systems
- For clockwise and anti-clockwise brake pistons
- In addition to pneumatic support, controlled rewinding by hand is also possible



**NOW EVEN GREATER MARKET COVERAGE!**

All adapters available individually in the VIGOR Catalogue 2020 from page 300!



V7132

EAN 4047728071321

**Hydraulic brake piston readjuster**

- Uniform resetting of the brake piston, without damage to piston and sealing
- Pressing jaws 360° adjustable – optimal adjustment
- Hydraulic support reduces expenditure of force
- Suitable for twin piston brake systems



Kr. 2045

For multiple piston brake systems!

Replaceable press jaws for clamping range 30 – 70 mm!

Maximum power transmission: 1500 kg  
2 pieces 90 mm press plates, width: 2 mm  
2 pieces 90 mm press plates, width: 4 mm  
2 pieces 150 mm press plates, width: 4 mm

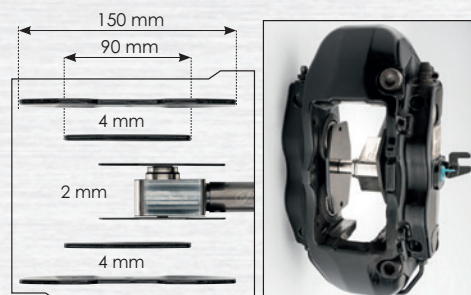

EAN 4047728071581

V7158

Kr. 775



**Brake calliper screw connection set**

- Brake calliper screw connection on, for example, VW · AUDI · PORSCHE · MERCEDES-BENZ · BMW · FORD · MAZDA and Volvo
- Including all common profile sizes for assembly and and removal of brake callipers
- Special profiles for loosening the screw connections of separated brake callipers



Special profiles



Ideal for floating and fixed callipers!

	VIGOR No.	□	Size mm	l mm	EAN 4047728+	Kr.		VIGOR No.	□	Size mm	l mm	EAN 4047728+	Kr.
①	V6632	10 3/8	9	-	066327	140,-	⑦	V7158-2	10 3/8	8	24	071604	95,-
②	V6633	12 1/2	22	-	066334	140,-	⑧	V7158-3	6.3 1/4	9	20	071611	95,-
③	V6634	10 3/8	20	-	066341	140,-	⑨	V7158-4	10 3/8	9	50	071628	95,-
④	V6635	12 1/2	11.5	-	066358	140,-	⑩	V7158-5	10 3/8	7	65	071635	95,-
⑤	V6636	12 1/2	14	-	071406	175,-	⑪	V7158-6	10 3/8	7	92	071642	95,-
⑥	V7158-1	10 3/8	7	24	071598	95,-	⑫	V7158-7	10 3/8	11	100	071659	95,-





EAN 4047728056779

**V5677**

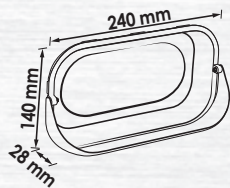

**Magnetic cup with plastic frame**

- Plastic frame offers a storage space for plastic screws etc. and also serves as a catch tray
- Magnetic cup magnetic on both sides – magnetic small parts adhere to back panel

**Kr. 150**  
incl. VAT

EAN 4047728070539

**V5678**

**Kr. 85**  
incl. VAT

*Magnetic cup magnetic on both sides – magnetic small parts adhere to back panel!*



**Magnetic half shell**

- For the workshop, production facilities or hobby room
- Solid plastic housing with optimised magnets
- Additional stabilisation below the magnets for straight laying of the half shells

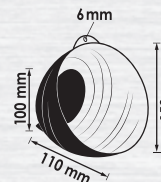

**approx. 2.5 kg**

**V6742**

EAN 4047728067423

**Kr. 240**  
incl. VAT

**Magnetic tool holder**

- Strong magnets (each with Ø 80 mm) guarantee a good hold on car lifts, tool trolleys or other magnetic substrates
- Magnetic holding force: approx. 20 kg

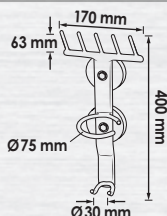

*Storage of impact sockets, impact wrenches, torque wrenches or hoses directly on site!*

**V2257**

EAN 4047728022576

**Impact socket set**

- Sizes 15 · 17 · 19 · 21 · 22 mm



With plastic sleeve

**5** **Kr. 390**  
incl. VAT

VIGOR No.	Ø	Size mm	l mm	EAN 4047728+	€
V2471	15	85	024716	90,-	
V2472	17	85	024723	90,-	
V2473	19	85	024730	95,-	
V2474	21	85	024747	105,-	
V2475	22	85	024754	115,-	

**V6031**

EAN 4047728071109

**Hydraulic service jack 2 t, extra long**

- Especially suited for use on commercial vehicles since the service jack sockets are often positioned deeper on these vehicles
- Extra long projection (940 mm) with ultra-flat build height
- Solid rubber pad for firm hold
- Robust steel body - guarantees high quality
- Foot pedal enables quick attachment to the service jack socket
- 42 kg

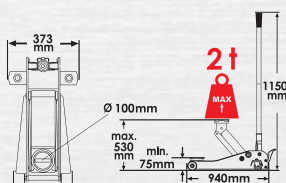

**Kr. 5370**

**Torque wrench**

- Torque release: palpable and audible
- Release accuracy tolerance ± 4% of scale value (in direction of actuation)
- With serial number and certificate
- DIN EN ISO 6789-2:2017, square according to DIN 3120, ISO 1174-1A



12.5 1/2 72 5°

	VIGOR No.	□	Nm	Scale graduation Nm	l mm	EAN 4047728+	Kr.
①	V3441	12.5 1/2	40-200	1	545	034418	1190,-
②	V3899	12.5 1/2	60-320	2	610	038997	1375,-

**Fine-tooth reversible ratchet!**

12.5 1/2

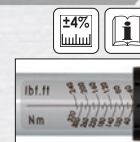



**V7181**

EAN 4047728071819

**Thread repair set for wheel bolts and wheel nuts**

Perfect for repairing and cleaning of wheel bolts and wheel nuts with inside or outside thread

- Not for impact operation
- Can be used directly on the vehicle
- TiN-HSS coated surface
- Suitable for the thread sizes::  
M12 x 1.25 mm  
M12 x 1.50 mm  
M14 x 1.50 mm

13



**Kr. 1090**

**NEW**

**Damaged or rusty threads can result in incorrect torque values!**

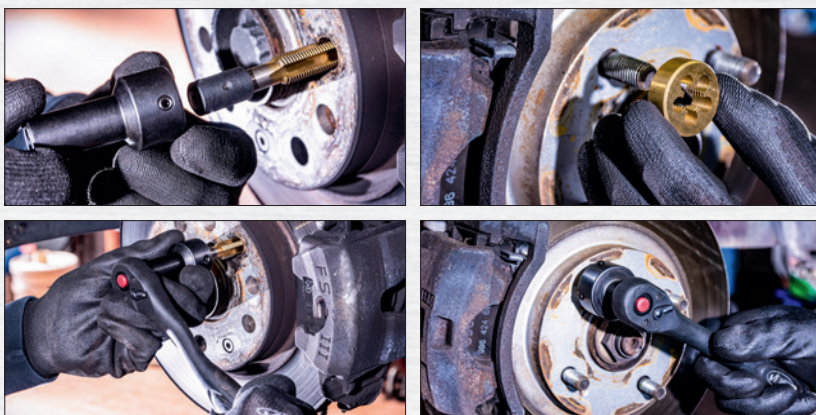

	VIGOR No.		EAN 4047728+	Kr.
①	<b>V7181-1</b>	M12 X 1,25 mm	071840	<b>245,-</b>
②	<b>V7181-2</b>	M12 X 1,50 mm	071833	<b>245,-</b>
③	<b>V7181-3</b>	M14 X 1,50 mm	071826	<b>245,-</b>
④	<b>V7181-4</b>	M12 X 1,25 mm	071864	<b>295,-</b>
⑤	<b>V7181-5</b>	M12 X 1,50 mm	071857	<b>295,-</b>
⑥	<b>V7181-6</b>	M14 X 1,50 mm	071871	<b>295,-</b>

EAN 4047728072601

**V4385N**

**Kr. 3490**

18

**Oil filling device with adapter set**

- Filling gearboxes and differentials with oil
- Incl. oil pan and 16 adapters for vehicles with limited installation space

**New improved set content!**

**NEW**



	VIGOR No.		EAN 4047728+	Kr.
①	<b>V7285</b>		072854	<b>230,-</b>
②	<b>V7286</b>		072861	<b>230,-</b>
③	<b>V7287</b>		072878	<b>230,-</b>
④	<b>V7288</b>		072885	<b>230,-</b>



V4891

EAN 4047728048910

**Induction heater, 1.5 kW**

- Quick, simple removal of parts on vehicles by heating
- Extremely versatile in the car body and commercial vehicle sector due to extensive standard accessories
- Accurately positioned heating within a few seconds due to cutting-edge microprocessor technology
- Easy to transport thanks to plastic case
- Prevention of overheating with a simultaneously high degree of efficiency due to two fans
- Connection cable: 700 mm
- Controlled fan cooling
- Tube coils: heating pipes, bolts, profiles of various diameters
- Flexible coil: for loosening parts that are difficult to access due to the use of a special winding wire
- Flat coil for heating the car body and sheet metal, makes it easier to remove stickers, sealants etc.
- Robust IGBT transistor technology
- Short circuit and idling test
- Automatic adaptation to resonance frequency
- Frequency: 25 kHz – 60 kHz
- 1.5 kW output

**Extremely versatile in the car body and commercial vehicle sector due to extensive standard accessories!**

You can find more coils in the VIGOR Catalogue 2020 on page 328!



5 **Kr. 8495**  
incl. VAT





**V4891-3.5**

EAN 4047728072779

**Induction heater, 3.5 kW**

- Powerful 3.5 kW variant for passenger car and commercial vehicle applications
- Efficient method of heating, without damaging surrounding components
- Water-cooled
- Portable, despite high performance
- Output power can be precisely adjusted for the application field
- Force can be output in increments between 10-100%
- Delivery includes cooling fluid
- Precise heating of components and elements
- Operating information via LED on the coil head
- Additional fan in the housing provides overheating protection for the hardware components
- Precise heating in just a few seconds with cutting-edge microprocessor technology

**NEW**



**2** **Kr. 31480**

**Accessories**

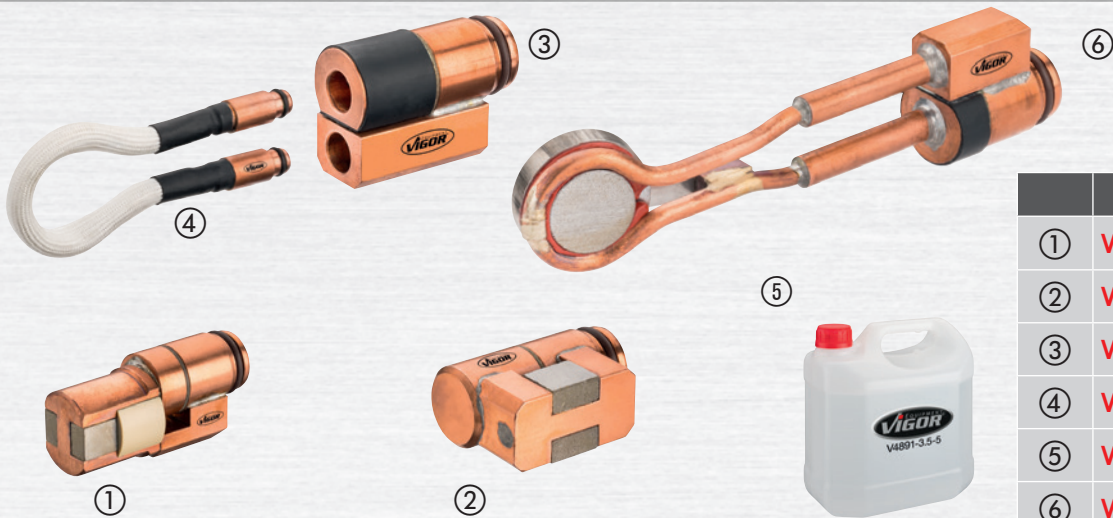

	VIGOR No.	EAN 4047728+	Kr.
①	<b>V4891-3.5-1</b>	072786	<b>4095,-</b>
②	<b>V4891-3.5-2</b>	072793	<b>4095,-</b>
③	<b>V4891-3.5-3</b>	072809	<b>2095,-</b>
④	<b>V4891-3.5-4</b>	072816	<b>4095,-</b>
⑤	<b>V4891-3.5-5</b>	072823	<b>545,-</b>
⑥	<b>V4891-3.5-6</b>	072892	<b>4095,-</b>

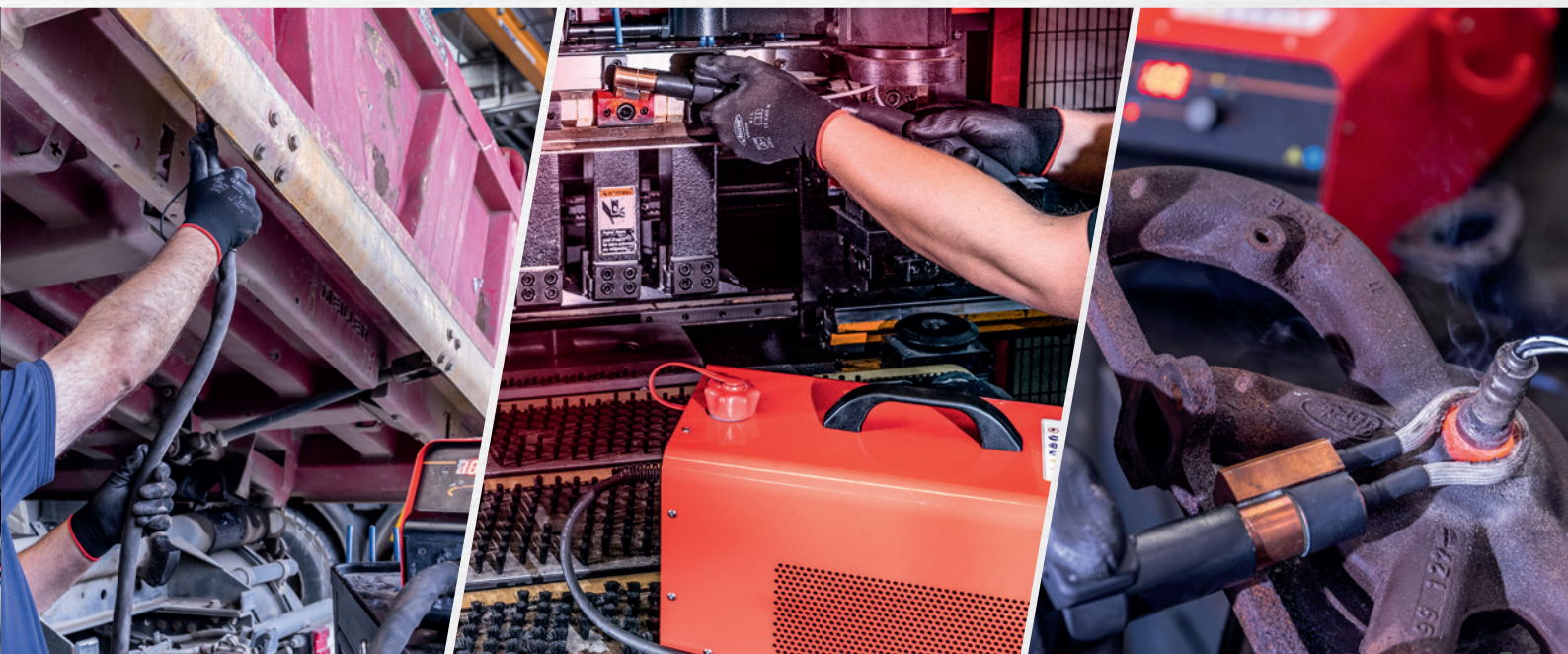



# EXTRA GREAT business incentive package!

Valid from 01/09 – 28/02/2021

**V4481-XD/948**

EAN 4047728072946

# FREE!



h x w x d  
1017 x 976 x 686 mm  
**V4481-XD/775**

Socket set, 172 pieces

**Incl. 947 expert tools!**

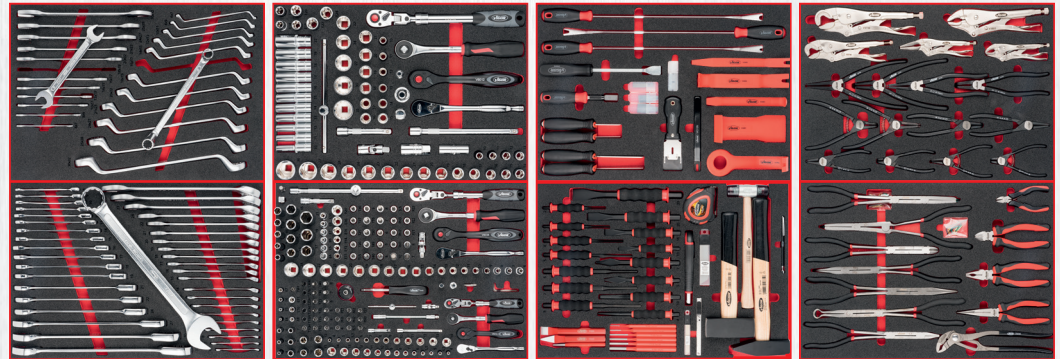

V5489

**+**  
**EXTRA DEEP**



h x w x d  
1000 x 677 x 495 mm  
**VIGOR 500N**

**FREE!**  
V2461N



**Offer has been extended!**



**SPECIAL PRICE**  
V4481-XD/948 COMPLETE, ONLY  
EAN 4047728072946

**Kr. 59990**  
excl. VAT

Non-binding recommended list price (RRP): 93073

**YOU SAVE: Kr. 33073**

VIGOR GmbH · Am Langen Siepen 13-15 · 42857 Remscheid · GERMANY  
www.vigor-equipment.com · info@vigor-equipment.com

Recommended retail prices (RRPs) without VAT; during the sale period, these prices replace all other RRP's. As long as stock lasts!



Valid until: 28/02/2021