



Lighting



Electrical
Components



Workshop
Consumables

ACCESSORIES

Lighting, Electrical Components & Workshop Consumables 2018/2019



HC-CARGO Always Online

The products you require are only a few clicks away!

www.hc-cargo.com





ACCESSORIES

LIGHTING, ELECTRICAL COMPONENTS & WORKSHOP CONSUMABLES



For full program overview visit
www.hc-cargo.com

Edition 2018/2019



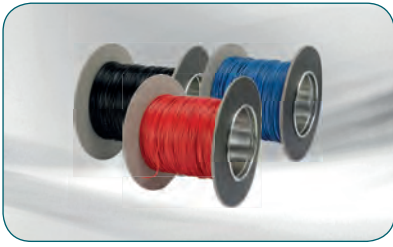

This new HC-CARGO Accessories catalogue covers these product groups:



Lighting

HC-CARGO offers a wide range of bright, long-lasting and economical lighting products for interior and exterior vehicle lighting. They meet the strictest mandatory safety regulations. Regular product testing and supplier audits ensure the quality and durability of HC-CARGO lighting products. The range is continuously developed with innovative products, with a special focus on LED technology:

- Rotating beacons
- Rear multi-function lamps
- Bulbs
- Work lamps
- Reflectors
- LED lamps



Electrical Components

Electrical components required at the auto electrical workshop or by the specialist who has excelled in building complete electrical systems for the automotive customer:

- CCTV rear observation systems for professional and private use
- Fans and blowers
- Wiper motors & FlexFit wiper blades
- Main Switches
- Power management products such as Inverters and Converters
...and many more electrical related products

Other Accessories and Tools

We offer many more parts for your daily business:

Electrical pumps. Horns. Blowers. Ignition switches. Gauges. Battery isolators. Universal lambda sensors. Parking assistants. Reverse alarms. Glow plugs. Shutdown solenoids. Wiring. Fuses. Relays. Plugs. Sockets. Multifunction testers. Extractors. Switches. Sensors. Contacts.



Workshop Consumables

We offer a comprehensive range of the components most commonly used in the automotive workshop.

These include cables, wiring and installation materials specifically for fitting electrical components and accessories.

We also offer a wide range of:

- Universal relays
- Specific relays for diesel applications
- Crimping tools and special tools for the purpose of dismantling and assembling starters and alternators
- Other electrical tools, including multi-meters and trailer connector testers.

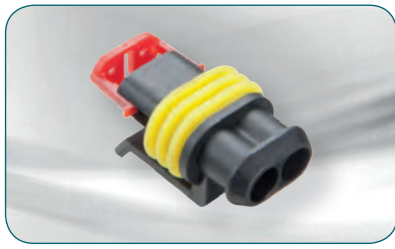

In addition to the extended product program, the catalogue provides a new and easy overview of each individual product range.

Moreover, you can also find more precise product information and detailed drawings on a larger number of products than before.

As we continuously are extending our portfolio to offer our customers the most comprehensive program you can always see an up-to-date- and complete program by using our web catalogue at www.hc-cargo.com

NEW retail packaging

For these product categories we are developing appealing packaging suitable for retail use.

- FlexFit wiper blades
- Bulbs
- Work lamps
- Warning lights
- Cameras & monitors
- Fuses, relays, connectors
- Inverters, converters

And more will follow as we develop our range. This makes the products stand out on shelf and are easier to find.



ACCESSORIES

<u>Acoustic Warning</u>	194
Buzzers.....	195
Horns.....	195
Reversing Alarms.....	194
<u>Adhesive</u>	539
Silicone Compound.....	539
<u>Assembly Parts</u>	548
Brass Olives.....	552
Eye Union.....	551
Fork Heads.....	550
Hollow Screws.....	551
Hose Nipples.....	550
Joints.....	549
Pipe Nipples.....	551
Retaining Rings for Shaft and Bores.....	551
Seals & Wire.....	548
Spring Pins.....	552
Valves.....	548
<u>Assortments</u>	179, 327, 595
ABS Connectors & Tools.....	597
ATO Blade Fuses.....	596
ATO/Mini/Maxi Fuses.....	606
ATO/Mini/PAL Fuses.....	606
Batteries.....	603
Battery Terminals II.....	604
Blue Crimp Terminals - Insulated.....	599
Boxes.....	601
Butt Splices.....	601
Cable Clips.....	601
Cable Joints.....	600
Cable Lugs.....	608
Cable Ties.....	598
Connectors & Insulators.....	596
Cord End Terminals.....	603
Crimp Seal Terminals.....	600
Crimp Terminals - Non-insulated.....	596
DT Connectors.....	606
DTM Connectors.....	607
Festoon Bulbs.....	180
Fuses - Micro / Mini Low Profile / PAL - Assortment.....	608
Glow Plugs.....	328
Heat Shrink Pipes I.....	602
Heat Shrink Pipes II.....	606
Hollow Screws & Hose Nipples.....	328
Hose Nipples.....	608
HSS Drills.....	610
Insulated Crimp Terminals.....	605
Insulated Terminals.....	596
Insulated Terminals w/ Tool.....	605
Junior-Timer/Junior-Power-Timer II.....	603
Lock Washer.....	601
Machine Screws & Nuts.....	5989
Maxi Blade Fuses II.....	607
Mega Blade Fuses.....	603
Micro Relays.....	609
Midi Blade Fuses.....	605

<u>Assortments</u>	179, 327, 595
Mini Blade Fuses.....	605
Mini Clamps.....	599
Mini Relays 12 V.....	609
Mini Rocker Switches.....	609
PAL Fuses II.....	602
PG Cable Glands.....	604
Pin Terminals - Non-insulated I.....	604
Pin Terminals - Non-insulated II.....	607
Protection Caps.....	600
PVC Caps.....	599
Red Crimp Terminals - Insulated.....	599
Ring Crimp Terminals - Insulated.....	597
Ring Nipples & Hose Sleeves.....	328
Rubber Clamps.....	597
Rubber Grommets & Blankings.....	598
Sealing Rings I.....	597
Single Core Cables.....	602
Strip Fuses.....	604
Strip Fuses - Closed Type.....	607
Super Seal Connectors.....	602
Tapping Screws I.....	601
Thermal Washers.....	328
Thin Wall Cables.....	608
Toggle Switches.....	609
Torpedo & Glass Fuses.....	598
Wedge-Base Bulbs 12 V I.....	180
Wedge-base Bulbs 12 V II.....	180
Wedge-base Bulbs 12 V III.....	180
Wedge-Base Bulbs 24 V.....	181
Yellow Crimp Terminals - Insulated.....	600
<u>Battery Terminals</u>	383
Brass Casting.....	383
For French Applications.....	389
Formpressed.....	388
Leads and Earth Straps.....	389
Quick release terminal.....	392
<u>Beacon Sockets</u>	40
Spare Parts.....	42
<u>Bulb Holders</u>	156
<u>Bulbs</u>	163
Conventional.....	174
Electric Vehicles and Forklifts.....	176
Festoon.....	173
Flash and Penlight.....	177
H1 Halogen.....	164
H2 Halogen.....	164
H3 Halogen.....	164
H4 Halogen.....	165
H6W Halogen.....	166
H7 Halogen.....	166
H8 American Types.....	168
H9 American Types.....	168
H10 American Types.....	168
H11 American Types.....	168
H13 Halogen.....	166

Care is taken to ensure the accuracy of descriptions and applications of each item, but **CAR GO** assumes no responsibility for possible errors. O.E.M. names and numbers are used for reference purposes only.
 Printed in Italy. Copyright © 2018 Holger Christiansen A/S, A Bosch Group Company

	PAGE
<u>Bulbs</u>	163
H15 Halogen	166
H21W Halogen.....	167
H27W/1 American Types	168
H27W/2 American Types.....	168
Halogen	176
HB1 American Types.....	167
HB3 A American Types.....	167
HB3 American Types.....	167
HB4 A American Types.....	167
HB4 American Types.....	167
HB5 American Types.....	167
High Intensity Discharge.....	169
Instrument Panel.....	174
LED.....	177
MH6 Halogen	165
Parking and Flasher - Position	171
Spare Lamp Kits.....	178
Stop and Flasher - Position.....	170
Stop and Tail Lamps	169
Wedge Base.....	172
Wedge Base - Covers.....	173
<u>Cabin Heaters</u>	280
Accessories	282
Connectors.....	282
Heater Motors	281
<u>Cable & Wiring</u>	512
Alligator & Universal Clips	532
Cable Clips.....	512
Cable Coils.....	533
Cable Eyelets.....	534
Cable Ties.....	514
Cables	521
Charging Clips	529
Chassis Clips.....	513
Connectors.....	515
End Plug.....	518
Flexible Convoluted Split Tubing	516
Flexible Convoluted Tubing	516
Glands	516
Grommet.....	517
Heat Shrink Tubing.....	518
Ignition	534
Pipe Clips	513
Polyurethan Wire Sleeving	518
PVC Sleeveings.....	518
Spiral Bindings	518
Tie Mount	514
Tools	520
<u>Camera & Parking Sensors</u>	184
CCTV Rear Observation System.....	184
Parking Sensors.....	193
<u>Circuit Breakers</u>	447
ATO Blade Fuse Type	447

	PAGE
<u>Circuit Breakers</u>	447
Panel Mount Type	447
<u>Clamps</u>	537
Ear Clips.....	538
Hose	537
Mini	537
Pipe.....	538
Tools	537
<u>Crimp Terminals</u>	330
Insulated	330
Non Insulated.....	333
Single Wire Seal.....	345
Terminal Cover	346
Tools	343
<u>Dashboard Gauges</u>	300
Ammeter	300
Fuel Gauges	302
Hour Meter.....	301
Oil Pressure Gauges	302
Voltmeter	300
Water Temp. Gauges	302
<u>Diesel Parts</u>	253
Bearings	253
Diesel Pump Parts	253
Feed Pumps.....	257
Filter Parts.....	264
Glow Plug Relays.....	270
Glow Plugs.....	268
Governor Parts	264
Injection Pipe Holders	264
Injection Pipes	264
Nozzle Holder Parts	265
Nozzles	265
Sealing Rings	266
VE Pump Parts.....	267
VE Throttle Shafts	267
<u>Dry Batteries</u>	541
Alkaline	542
Battery Charger.....	546
Button	543
Carbon-Zinc.....	541
Lithium	543
Rechargeable	545
<u>Fans & Blowers</u>	275
Axial Fans	275
Blowers.....	271
Fan/Heater Motors	273
<u>Fastening Parts</u>	579
Bushings.....	590
Cotter Pins.....	590
Flame Arresters	586
Hex Screws	580
Machine Screws	582

ABBREVIATIONS:

A/C=Air Condition, Alu=Aluminium, Amp=Ampere, AT=Automatic Transmission, Cat.=Catalyzer, Cyl.=Cylinder, CW=Clockwise rotation, Eur.=European application, FWD.=Front Wheel Drive, H=Hight, HD=Heavy Duty construction, HP=Horse Power, ID=Inner Diameter, kW.=Kilowatt, L=Length, LHD=Left Hand Drive, LL.=Lead Length, M=Minimum supply, MT=Manual Transmission, m=Metre, OD=Outer Diameter, OE=Original Equipment, PS=Power Steering, RHD=Right Hand Drive, Th.=Thickness, V=Volt, w/=With, w/o=Without, W.=Width, 4WD.=Four Wheel Drive.

PAGE

<u>Fastening Parts</u>	579
Nuts	584
Rivets	590
Tapping Screws	579
Washers	587
<u>Filters & Filter Parts</u>	248
Fuel Filters	248
Fuel Heaters	250
Spare Parts	251
Water Separator	250
<u>Forward Lighting</u>	65
Driving Lamp Conventional	70
Driving Lamp LED	71
Flasher-Position Lamps Conventional	76
Flasher-Position Lamps LED	77
Fog Lamps	69
Headlight Inserts	68
Position Lamps Conventional	72
Position Lamps LED	73
Sealed Beams	68
Tractor Head Lamps	65
<u>Fuses</u>	427
ATO Blade	428
Car Radio Fuses	427
Compact	432
Fuse Boxes	434
Fuse Cards	433
Fuse Holders	436
Glass	427
HSB	429
Maxi Blade	428
Mega	429
Micro 3 Blade Fuse	427
Micro Blade	427
Midi	428
Mini Blade	428
Mini Blade Low Profile	428
PAL 283	430
PAL 293	430
PAL 2935	430
PAL 2938	430
PAL 294	430
PAL 295	430
PAL JCase	431
PAL Low Profile	431
Smart Glow	429
Strip	431
Tester/Extractors	433
Torpedo	427
Various	434
<u>Hand Lamps Conventional</u>	154, 558
Spare Parts/Accessories	155, 558
<u>Hand Lamps LED</u>	155, 558
Spare Parts	156, 558
<u>Hoses</u>	534
Armoured Plastic	535
Heater	535
Non-woven	534
Overflow	535
Plastic	534

PAGE

<u>Hoses</u>	534
Polyamid	535
Synthetic Rubber Steel Wire	535
Vacuum	536
Woven	534
<u>Ignition Components</u>	303
Electronic Kits	311
Ignition Coils	303
Modules	306
<u>Indicator Lights</u>	444
LED	445
<u>Industrial Battery Connectors</u>	393
50 Ampere	393
80 Ampere	394
100 Ampere	394
160 Ampere	394
175 Ampere	395
250 Ampere	396
300 Ampere	397
320 Ampere	397
350 Ampere	397
<u>Interior Lamps Conventional</u>	137
<u>Interior Lamps Flourescent</u>	142
Spare Parts	143
<u>Interior Lamps LED</u>	138
<u>Junction Boxes</u>	507
Accessories	510
<u>Multiple Connectors</u>	348
3 Pole	379
4 Pole	379
Cables	380
Deutsch-Connector Accessories	368
Deutsch-Connector DT	354
Deutsch-Connector DTM	360
Deutsch-Connector DTP	367
Deutsch-Connector HD	369
Deutsch-Connector HDP	369
Holders	350
Insulators	348
Junior-Power-Timer Accessories	375
Junior-Power-Timer Connector	374
Junior-Timer Connector	373
Power	379
Superseal	370
Tools	376
<u>Oil & Grease</u>	540
Bearing Grease	540
Heat Transfer Compound	541
Multi Purpose Grease	541
<u>Pen/Torch Lights</u>	153
Pen-/Torch Lights LED	154
Torch Light LED/UV	153
<u>Pipes</u>	536
Hose Sleeves	536
Nuts	536
<u>Plugs & Sockets</u>	398
Accessories	420

	PAGE
<u>Plugs & Sockets</u>	398
Adapters - 12/24 V	402
Adapters 12 V	403
Cable kits 12 V	417
DIN and Cigarette Lighter	398
Distributor Box	406
ISOBUS	417
NATO Cable Connectors	421
Trailer Coils 12 V	418
Trailer Coils 24 V	419
Trailer Plugs - 12 V	412
Trailer Plugs - 24 V	414
Trailer Plugs - 6/24 V	416
Trailer Sockets - 12 V	406
Trailer Sockets - 24 V	409
Trailer Sockets - 6/24 V	412
<u>Power Management Components</u>	199
Battery Isolators	214
Chargers	212
Load Resistors	212
Power Guard	214
Relay Boxes	203
Voltage Converters	199
Voltage Inverters	203
Voltage Reducer	211
<u>Powr-Bloks</u>	483
Accessories	485
Bridge	485
<u>Protecting Caps, Tubes & Plugs</u>	546
Protecting Caps	546
Protecting Tubes	547
Rubber Boots	547
Rubber Caps	547
Threaded Plug	547
Threaded protection cap	547
<u>Pumps & Pump Parts</u>	238
Electrical Bilge Pumps	238
Electrical Fluid Pumps	240
Electrical Fuel Pumps	242
Electrical Water Pumps	239
Fuel Injection Pumps	248
<u>Radio Accessories</u>	297
Aerials	297
Capacitors	298
Loudspeaker Built-in	299
Loudspeaker in Cabinet	299
Radio Mounting Kits	299
<u>Reflectors</u>	143
Accessories	146
Container Marking	152
Hazard Warning Lights	153
Miscellaneous Rear Marking	146
Rear Marking Trailers	148
Rear Marking Trucks	149
Triangles	152
Warning Triangles	152
<u>Relays</u>	448
Acoustic Warning	448
Boxes	482

	PAGE
<u>Relays</u>	448
Change Over - 12 V	459
Change Over - 24 V	461
Charge Relays	473
Daytime Running Lights	448
Flasher Units - 12 V	468
Flasher Units - 24 V	472
Flasher Units - 6 V	468
Flip Flop	463
Fuel Pumps	466
Glow Plug Relays	474
Hazard Warning Light System	468
Multi Plugs	480
Multitimer	465
Radiator Fans	465
Time Delay - 12 V	464
Time Delay - 24 V	464
Timing Devices	465
Trailer Switch Boxes	482
Work Relays	449
<u>Search Lights</u>	64
Conventional	64
<u>Side Indicators Conventional</u>	77
Spare Parts	78
<u>Side Indicators LED</u>	79
<u>Side Marker Lamps Conventional</u>	79
Spare Parts	80
<u>Side Marker Lamps LED</u>	80
Accessories	83
<u>Solenoids</u>	227
Advance Solenoids	235
Solenoid Shutdown	230
Solenoid Shutdown-Kits	227
Solenoid Stop	236
<u>Surface Cleaning</u>	539
Abrasive Cloths	540
<u>Switches</u>	216
Battery Switches	216
Control Boxes	224
Diesel Starter	226
Door & Burglar Alarm	506
Emergency Stop Switches	223
Ignition Starter	225
Ignition/Light	224
Mini Rocker	487
Multi Purpose	504
Push Button	502
Push-Pull	501
Push-Push	503
Rocker	489
Rotating	486
Spare Parts	226
Toggle	497
<u>Switches & Sensors - Engine Management</u>	312
Sensors	321
Switches	312
Thermo Sensor Switches	318

PAGE

<u>Tail Lights</u>	83
Multi Function Lamps	86
Numberplate Lamps Conventional	130
Numberplate Lamps LED	131
Rear Fog Lamps Conventional	85
Rear Fog Lamps LED	85
Reversing Lamps Conventional	83
Reversing Lamps LED	84
Tail Lamps Conventional	121
Tail Lamps LED	121
Tail Position Lamps Conventional	124
Tail Position Lamps LED	126
Tail-Lift Lamps Conventional	133
Tail-Lift Lamps LED	133
Trailer Lighting Sets	133
<u>Tapes</u>	538
Field Coil Tape	538
Insulation Tape	538
Masking	539
Textile Tape	538
Thread Seal Tape	539
<u>Tools</u>	552
A/C Parts	577
Adjustment Tools	567
Bits 1/4"	577
Bits 5/16"	579
Combi Tools	559
Dies and Taps	559
Drive Tools	566
Hand Lamps Conventional	558
Hand Lamps LED	558
Hose Clamp Screwdrivers	559
HSS Drills	552
Lambda Sensor Tool	564
Protecting Masks	557
Remove/Install	565
Safety Glasses	557
Soldering	553
Solenoid Coil	566
Solenoid Tools	566
Special Tools	567
Test Injection Pipes	567
Threaded Inserts	559
TPMS	568
Work Gloves	556
Works and Test Equipment	570
<u>Warning Lights</u>	10
Flash Lights LED	24
Light Bars Conventional	33
Light Bars LED	33
Rotating Beacons Conventional	10
Rotating Beacons LED	16
Rotating Beacons Xenon	22
Spot Lights	40
<u>Wiper Systems</u>	296
Windscreen Washers	296
Wiper Arms	285
Wiper Blades	283
Wiper Motors	287

PAGE

<u>Work Lamps Conventional</u>	43
Accessories	48
<u>Work Lamps LED</u>	48
Accessories	57
Spot Lights LED	63
Work Light Bars LED	58
<u>Cross Referece List</u>	611
<u>Index</u>	665



Lighting

Edition 2018/2019



WARNING LIGHTS

ROTATING BEACONS CONVENTIONAL

170295 Rotating Beacon Std pkg 1

Dome: HC-CARGO 170308, 170366. Motor: HC-CARGO 170505. Base Plate: HC-CARGO 170309.

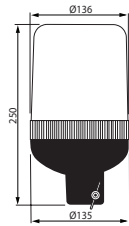

Bulb incl.: Yes
Voltage: 12

OD: 136 mm
Height: 250 mm

Bulb type: H1
Lens type: PMMA/ACRYL
Colour: Orange
Model: AEB TYPE 590
Mount.: Standard ISO A - Rod
E-approval: Yes
Alternativ no.: 171399

170296 Rotating Beacon Std pkg 1

Dome: HC-CARGO 170308, 170366. Motor: HC-CARGO 170506. Base Plate: HC-CARGO 170309.

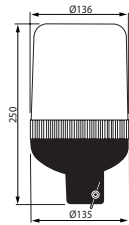

Bulb incl.: Yes
Voltage: 24

OD: 136 mm
Height: 250 mm

Bulb type: H1
Lens type: PMMA/ACRYL
Colour: Orange
Model: AEB TYPE 590
Mount.: Standard ISO A - Rod
E-approval: Yes
Alternativ no.: 171399

170435 Rotating Beacon Std pkg 1

Dome: HC-CARGO 170308, 170366. Motor: HC-CARGO 170505. Base Plate: HC-CARGO 170309.

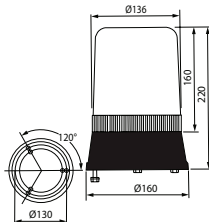

Bulb incl.: Yes
Voltage: 12

OD: 160 mm
Height: 220 mm

Bulb type: H1
Lens type: PMMA/ACRYL
Colour: Orange
Model: AEB TYPE 595
Mount.: Standard ISO B2 (and B1) - Base
E-approval: Yes

170436 Rotating Beacon Std pkg 1

Dome: HC-CARGO 170308, 170366. Motor: HC-CARGO 170506. Base Plate: HC-CARGO 170309.

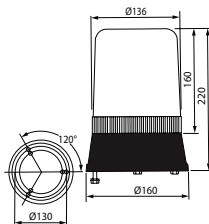

Bulb incl.: Yes
Voltage: 24

OD: 160 mm
Height: 220 mm

Bulb type: H1
Lens type: PMMA/ACRYL
Colour: Orange
Model: AEB TYPE 595
Mount.: Standard ISO B2 (and B1) - Base
E-approval: Yes

170437 Rotating Beacon Std pkg 1

Dome: HC-CARGO 170308, 170366. Motor: HC-CARGO 170505. Base Plate: HC-CARGO 170309. Coil cable: lenght 2 m.

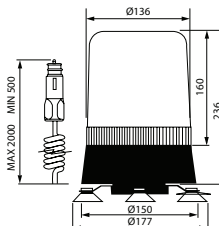

Bulb incl.: Yes
Voltage: 12

OD: 177 mm
Height: 236 mm

Bulb type: H1
Lens type: PMMA/ACRYL
Colour: Orange
Model: AEB TYPE 595 M
Mount.: 3 magnets
Base: Magnetic
Coiled cable incl.: Yes
E-approval: Yes

170438 Rotating Beacon Std pkg 1



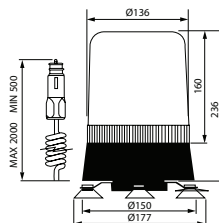





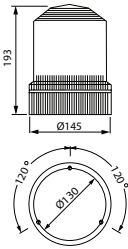

Dome: HC-CARGO 170308, 170366. Motor: HC-CARGO 170505. Base Plate: HC-CARGO 170309. Coil cable: lenght 2 m.

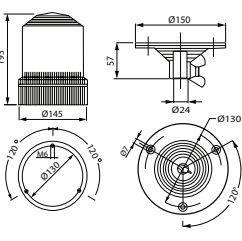

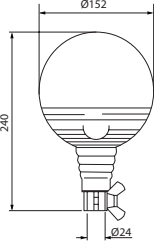
Bulb incl.: Yes
Voltage: 24

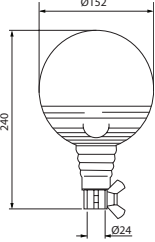
OD: 177 mm
Height: 236 mm

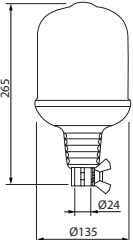
Bulb type: H1
Lens type: PMMA/ACRYL
Colour: Orange
Model: AEB TYPE 595 M
Mount.: 3 magnets
Base: Magnetic
Coiled cable incl.: Yes
E-approval: Yes

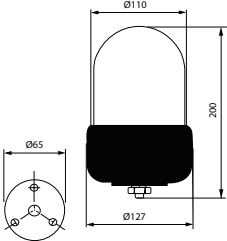
170490 Rotating Beacon		Std pkg 1			
Dome: HC-CARGO 170492. Beacon Socket: HC-CARGO 170525. Base Plate: HC-CARGO 170528.					
		Bulb incl.: No Voltage: 12/24	OD: 145 mm Height: 193 mm	Bulb type: H1 Lens type: PMMA/ACRYL Colour: Orange Model: TYPE FT 6 Mount.: Standard ISO B2 (and B1) - Base Tightness norm: IP 55 E-approval: Yes	
170491 Rotating Beacon		Std pkg 1			
Dome: HC-CARGO 170492. Base Plate: HC-CARGO 170528.					
		Bulb incl.: No Voltage: 12/24	OD: 150 mm Height: 250 mm	Bulb type: H1 Lens type: PMMA/ACRYL Colour: Orange Model: TYPE FT 6 Mount.: Standard ISO-DIN A or B fixing Base: Rigid Tightness norm: IP 55 E-approval: Yes	
170540 Rotating Beacon		Std pkg 1			
Dome: HC-CARGO 170543.					
		Bulb incl.: Yes Voltage: 12	OD: 152 mm Height: 240 mm	Bulb type: H1 Lens type: Polycarbonate Colour: Orange Model: Boule Mount.: Standard ISO A - Rod Base: Flexible Hi impact: Yes Waterproof: Yes Tightness norm: IP 66 E-approval: Yes	
170541 Rotating Beacon		Std pkg 1			
Dome: HC-CARGO 170543.					
		Bulb incl.: Yes Voltage: 24	OD: 152 mm Height: 240 mm	Bulb type: H1 Lens type: Polycarbonate Colour: Orange Model: Boule Mount.: Rod (ISO-DIN A) Base: Flexible Hi impact: Yes Tightness norm: IP 66 E-approval: Yes	
170551 Rotating Beacon		Std pkg 1			
		Bulb incl.: Yes Voltage: 12	OD: 135 mm Height: 265 mm	Bulb type: H1 Lens type: Polycarbonate Colour: Orange Model: TYPE GF 8.8 FLX Mount.: Standard ISO A - Rod Base: Flexible Hi impact: Yes Tightness norm: IP 54 E-approval: Yes	
170598 Rotating Beacon		Std pkg 1			
Dome: HC-CARGO 170691.					
		Bulb incl.: No Voltage: 12/24	OD: 127 mm Height: 200 mm	Bulb type: H1 Lens type: PMMA/ACRYL Colour: Orange Model: AEB TYPE 525 Mount.: Single bolt E-approval: Yes	

170599 Rotating Beacon Std pkg 1

Dome: HC-CARGO 170691.

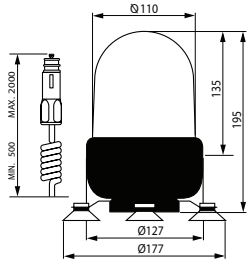
 Bulb incl.: No
Voltage: 12/24

 OD: 127 mm
Cable length: 2000 mm
Height: 195 mm

 Bulb type: H1
Lens type: PMMA/ACRYL
Colour: Orange
Model: AEB TYPE 525 M
Mount.: 3 magnets
Base: Magnetic
Coiled cable incl.: Yes
E-approval: Yes

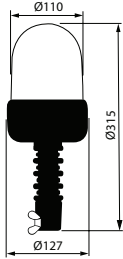
170601 Rotating Beacon Std pkg 1

 Bulb incl.: No
Voltage: 12/24

 OD: 127 mm
Height: 315 mm

 Bulb type: H1
Lens type: Polycarbonate
Colour: Orange
Model: AEB TYPE 530 B
Mount.: Standard ISO A - Rod
Base: Flexible
Hi impact: Yes
E-approval: Yes

170798 Rotating Beacon Std pkg 1

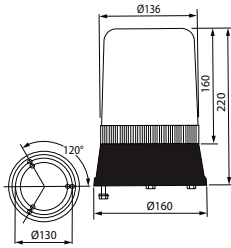
Dome: HC-CARGO 170308, 170366. Motor: HC-CARGO 170505, 170506. Base Plate: HC-CARGO 170309.



 Bulb incl.: No
Voltage: 12/24

 OD: 160 mm
Height: 220 mm

 Bulb type: H1
Lens type: PMMA/ACRYL
Colour: Blue
Model: AEB TYPE 595
Mount.: Standard ISO B2 (and B1) - Base
E-approval: Yes

170830 Rotating Beacon Std pkg 1

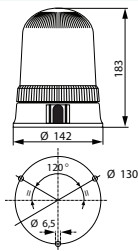
Dome: HC-CARGO 170945.

 Bulb incl.: No
Voltage: 12/24

 OD: 142 mm
Height: 183 mm

 Bulb type: H1
Lens type: PMMA/ACRYL
Colour: Orange
Mount.: Standard ISO B2 (and B1) - Base
E-approval: Yes

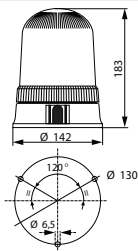
171019 Rotating Beacon Std pkg 1

 Bulb incl.: No
Voltage: 12/24



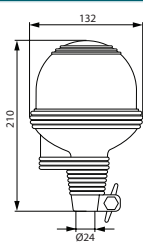





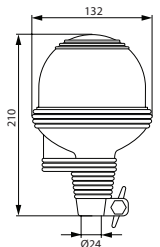

 OD: 142 mm
Height: 183 mm

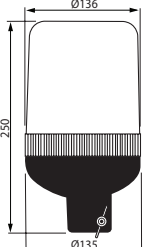
 Bulb type: H1
Lens type: PMMA/ACRYL
Colour: Blue
Model: Astral
Mount.: Standard ISO B2 (and B1) - Base
E-approval: Yes

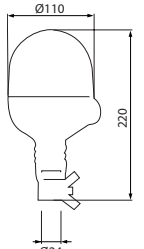
171060 Rotating Beacon Std pkg 1

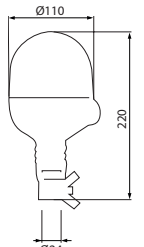
 Bulb incl.: Yes
Voltage: 12

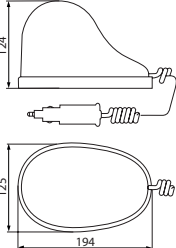
 OD: 132 mm
Height: 210 mm

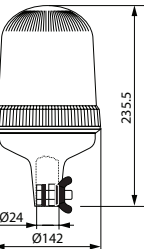
 Bulb type: H1
Lens type: Polycarbonate
Colour: Orange
Model: Megalux
Mount.: Standard ISO A - Rod
Base: Flexible
Hi impact: Yes
E-approval: Yes

		EL. SPECIFICATIONS	DIMENSIONS	ADDITIONAL SPECIFICATIONS
171061 Rotating Beacon Std pkg 1				
		Bulb incl.: Yes Voltage: 24	OD: 132 mm Height: 210 mm	Bulb type: H1 Lens type: Polycarbonate Colour: Orange Model: Megalux Mount.: Standard ISO A - Rod Base: Flexible Hi impact: Yes E-approval: Yes
171399 Rotating Beacon Std pkg 1				
<i>Dome: HC-CARGO 170308, 170366. Motor: HC-CARGO 170505, 170506. Base Plate: HC-CARGO 170309.</i>				
		Bulb incl.: No Voltage: 12/24	OD: 136 mm Height: 250 mm	Bulb type: H1 Lens type: PMMA/ACRYL Colour: Orange Model: 590 DVO Mount.: Standard ISO A - Rod E-approval: Yes
171423 Rotating Beacon Std pkg 1				
		Bulb incl.: Yes Voltage: 12 Watt: 55	OD: 110 mm Height: 220 mm	Bulb type: H1 Lens type: Polycarbonate Colour: Orange Model: Microboule Mount.: Standard ISO A - Rod Base: Flexible Hi impact: Yes Tightness norm: IP 55 Approval: CE E-approval: Yes
171424 Rotating Beacon Std pkg 1				
		Bulb incl.: Yes Voltage: 24 Watt: 55	OD: 110 mm Height: 220 mm	Bulb type: H1 Lens type: Polycarbonate Colour: Orange Model: Microboule Mount.: Rod (ISO-DIN A) Base: Flexible Hi impact: Yes Tightness norm: IP 55 Approval: CE E-approval: Yes
171494 Rotating Beacon Std pkg 1				
<i>Tested for 200 kmh. Lens: HC-CARGO 171512. 2 mtr. coiled cable. Rubber base. Coiled Cable: HC-CARGO 171562.</i>				
		Bulb incl.: Yes Voltage: 12	OD: 125 mm Length: 194 mm Height: 124 mm	Bulb type: H1 Lens type: Polycarbonate Colour: Orange Model: GDO Mount.: 1 magnet Base: Magnetic Hi impact: Yes Coiled cable incl.: Yes Tightness norm: IP 55 E-approval: Yes
171577 Rotating Beacon Std pkg 1				
<i>Dome: HC-CARGO 170945.</i>				
		Bulb incl.: Yes Voltage: 12	OD: 142 mm Height: 235.5 mm	Bulb type: H1 Colour: Orange Model: Astral Mount.: Standard ISO A - Rod Base: Rigid E-approval: Yes

171587 Rotating Beacon Std pkg 1

Dome: HC-CARGO 170945.

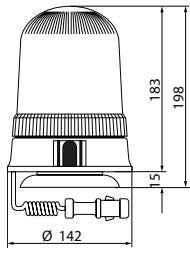

 Bulb incl.: No
Voltage: 12/24

 OD: 142 mm
Height: 198 mm

 Bulb type: H1
Colour: Orange
Model: Astral
Mount.: 1 magnet
Coiled cable incl.: Yes
E-approval: Yes

171588 Rotating Beacon Std pkg 1

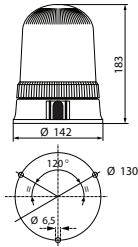
Dome: HC-CARGO 170945.



 Bulb incl.: No
Voltage: 12/24

 OD: 142 mm
Height: 183 mm

 Bulb type: H1
Colour: Orange
Model: Astral
Mount.: Single bolt
E-approval: Yes

171705 Rotating Beacon Std pkg 1

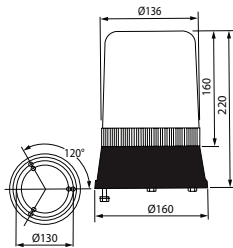
Dome: HC-CARGO 170308. Motor: HC-CARGO 170505, 170506.



 Bulb incl.: No
Voltage: 12/24

 OD: 160 mm
Height: 220 mm

 Bulb type: H1
Lens type: PMMA/ACRYL
Colour: Orange
Model: AEB TYPE 595
Mount.: Plan (ISO-DIN B)
E-approval: Yes

171793 Rotating Beacon Std pkg 1

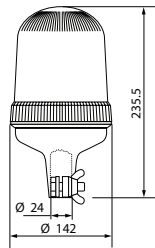
Dome: HC-CARGO 170945.



 Bulb incl.: No
Voltage: 12/24

 OD: 142 mm
Height: 235.5 mm

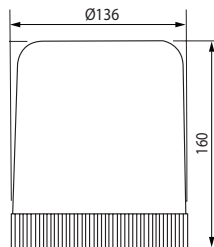
 Bulb type: H1
Lens type: Polycarbonate
Colour: Orange
Model: Astral flex
Mount.: Standard ISO A - Rod
Base: Flexible
Hi impact: Yes
E-approval: Yes

SPARE PARTS
170308 Dome Std pkg 1 Servicing: HC-CARGO 170295, 170296, 170435, 170436, 170437, 170438, 170798, 171399, 171705

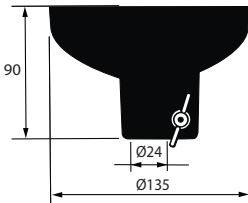
 OD: 136 mm
Height: 160 mm

 Lens type: PMMA/ACRYL
Colour: Orange
Model: TYPE 590/595/595M

170309 Base Plate Std pkg 1 Servicing: HC-CARGO 170295, 170296, 170435, 170436, 170437, 170438, 170798, 171399

 OD: 135 mm
Height: 90 mm

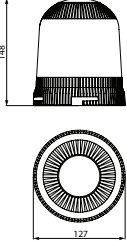
Model: TYPE 590/595/595M

EL. SPECIFICATIONS		DIMENSIONS		ADDITIONAL SPECIFICATIONS	
170366 Dome	Std pkg 1	Servicing: HC-CARGO 170295, 170296, 170435, 170436, 170437, 170438, 170798, 171399		OD: 136 mm Height: 160 mm	Lens type: PMMA/ACRYL Colour: Blue Model: TYPE 590/595/595M
					
170492 Dome	Std pkg 1	Servicing: HC-CARGO 170490, 170491		OD: 134 mm Height: 151 mm	Lens type: PMMA/ACRYL Colour: Orange Model: TYPE FT 6 Hi impact: No
					
170505 Beacon Motor	Std pkg 1	Servicing: HC-CARGO 170295, 170435, 170437, 170438, 170798, 171399, 171705		Voltage: 12 Height: 65 mm Width: 30 mm	Model: TYPE 590/595/595M
					
170506 Beacon Motor	Std pkg 1	Servicing: HC-CARGO 170296, 170436, 170798, 171399, 171705		Voltage: 24 Height: 65 mm Width: 30 mm	Model: TYPE 590/595/595M
					
170528 Base Plate	Std pkg 1	Servicing: HC-CARGO 170491, 170490, 170650, 170651, 171498, 170680		OD: 150 mm Height: 58 mm	Model: TYPE FT 6 Mount.: Standard ISO A - Rod
					
170543 Dome	Std pkg 1	Servicing: HC-CARGO 170540, 170541		OD: 152.5 mm Height: 120.5 mm	Lens type: Polycarbonate Colour: Orange Model: Boule Hi impact: Yes
					
170691 Lens	Std pkg 1	Servicing: HC-CARGO 170598, 170599			Lens type: PMMA/ACRYL Colour: Orange Model: TYPE 525/525 M Hi impact: No
					

170945 Dome		Std pkg 1	Servicing: HC-CARGO 170830, 171019, 171577, 171587, 171588, 171793, 172027, 172028, 172029, 172030, 172075	
			OD: 127 mm Height: 148 mm	Lens type: PMMA/ACRYL Colour: Orange Model: Astral E-approval: Yes Alternativ no.: 171463

171518 Coiled Cable		Std pkg 1	Servicing: HC-CARGO 170292, 170387, 170405, 170788, 170406, 170562, 170789, 170537, 171576, 170419, 170460	
			Working length: 2 m	Plug type: Cigar plug Plug 1: 2 ISO norm: 4165

171562 Coiled Cable		Std pkg 1	Servicing: HC-CARGO 171494, 171495	
			Working length: 3 m	Plug type: Cigar plug

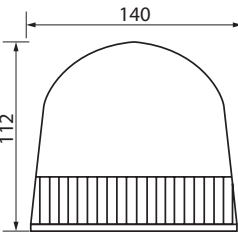
172110 Dome		Std pkg 1	Servicing: HC-CARGO 172099, 172100, 172101	
			OD: 140 mm	Lens type: PMMA/ACRYL Colour: Orange E-approval: Yes

ACCESSORIES

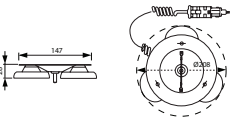
170525 Beacon Socket		Std pkg 1	Servicing: HC-CARGO 170490, 171017	
			Cable length: 2000 mm Height: 28 mm Width: 147 mm	Model: TYPE FT 6 Mount.: 3 magnets Base: Magnetic Coiled cable incl.: Yes Tightness norm: IP 55

ROTATING BEACONS LED

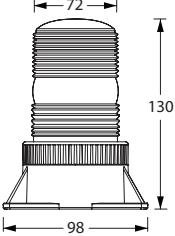
171673 LED Beacon		Std pkg 1	Voltage: 11-110 Amp: 0.7 Watt: 6	
			OD: 98 mm Length: 98 mm Cable length: 300 mm Height: 130 mm	Bulb type: 6 LED Lens type: Polycarbonate Flash rate: 45 min. Colour: Orange Mount.: Plan Flash patterns: 1 Hi impact: Yes Coiled cable incl.: No Waterproof: Yes Tightness norm: IP 66 Approval: SAE/CE E-approval: No

<p>171674 LED Beacon Std pkg 1</p>	<p>Voltage: 11-110 Amp: 0.7 Watt: 6</p>	<p>OD: 130 mm Cable length: 300 mm Height: 98 mm</p>	<p>Bulb type: 6 LED Lens type: Polycarbonate Flash rate: 45 min. Colour: Orange Mount.: Plan Flash patterns: 5 Hi impact: Yes Coiled cable incl.: No Waterproof: Yes Tightness norm: IP 68 Approval: SAE/CE E-approval: No Alternativ no.: 172145</p>
<p>171763 LED Beacon Std pkg 1</p>	<p>Voltage: 12/24 Amp: 1.7/0.8 Watt: 45</p>	<p>OD: 120 mm Height: 121 mm</p>	<p>Bulb type: 8 LED Lens type: Polycarbonate Flash rate: 130 min. Colour: Orange Material: Aluminium Mount.: Standard ISO A - Rod Base: Rigid Flash patterns: 2 Hi impact: Yes Waterproof: Yes Tightness norm: IP 66 Approval: ECE-R65 E-approval: Yes</p>
<p>171764 LED Beacon Std pkg 1</p>	<p>Voltage: 12/24 Amp: 1.7/0.8 Watt: 45</p>	<p>OD: 148 mm Height: 74 mm Dist. mount. holes: 130 mm</p>	<p>Bulb type: 8 LED Lens type: Polycarbonate Flash rate: 130 min. Colour: Orange Material: Aluminium Mount.: Plan Flash patterns: 2 Hi impact: Yes Waterproof: Yes Tightness norm: IP 66 Approval: ECE-R65 E-approval: Yes</p>
<p>171918 LED Beacon Std pkg 1</p> <p>Dome: HC-CARGO 171941.</p>	<p>Voltage: 12-24 Amp: 1.2/2.9 Watt: 37</p>	<p>OD: 142 mm Cable length: 400 mm Height: 128 mm</p>	<p>Bulb type: 10 LED Lens type: Polycarbonate Colour: Orange Material: Aluminium Mount.: Plan Flash patterns: 11 Hi impact: Yes Coiled cable incl.: No Waterproof: Yes Tightness norm: IP 65 Approval: SAE/ECE-R65, CISPR 25 Class 5 E-approval: Yes</p>
<p>171919 LED Beacon Std pkg 1</p> <p>Dome: HC-CARGO 171941.</p>	<p>Voltage: 12-24 Amp: 1.2/2.9 Watt: 37</p>	<p>OD: 142 mm Cable length: 3000 mm Height: 128 mm</p>	<p>Bulb type: 10 LED Lens type: Polycarbonate Colour: Orange Material: Aluminium Mount.: Lighter Socket Base: Magnetic Flash patterns: 11 Hi impact: Yes Waterproof: Yes Tightness norm: IP 65 Approval: SAE/ECE-R65, CISPR 25 Class 5 E-approval: Yes</p>

171920 LED Beacon Std pkg 1

Dome: HC-CARGO 171941.

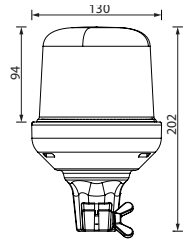

Voltage: 12-24
Amp: 1.2/2.9
Watt: 37

OD: 130 mm
Height: 202 mm

Bulb type: 10 LED
Lens type: Polycarbonate
Colour: Orange
Material: Aluminium
Mount.: Standard ISO A - Rod
Flash patterns: 11
Hi impact: Yes
Waterproof: Yes
Tightness norm: IP 65
Approval: SAE/ECE-R65, CISPR 25 Class 5
E-approval: Yes

171921 LED Beacon Std pkg 1

Dome: HC-CARGO 171942.

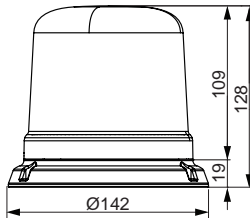

Voltage: 12-24
Amp: 1.2/2.9
Watt: 37

OD: 142 mm
Height: 128 mm

Bulb type: LED
Lens type: Polycarbonate
Colour: Blue
Material: Aluminium
Mount.: Plan
Flash patterns: 11
Hi impact: Yes
Coiled cable incl.: No
Waterproof: Yes
Tightness norm: IP 65
Approval: SAE/ECE-R65, CISPR 25 Class 5
E-approval: Yes

171922 LED Beacon Std pkg 1

Dome: HC-CARGO 171942.

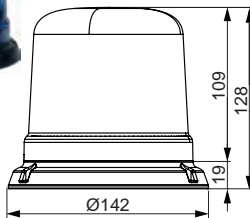

Voltage: 12-24
Amp: 1.2/2.9
Watt: 37

OD: 142 mm
Height: 128 mm

Bulb type: 10 LED
Lens type: Polycarbonate
Colour: Blue
Material: Aluminium
Mount.: 3 magnets
Flash patterns: 11
Hi impact: Yes
Coiled cable incl.: Yes
Waterproof: Yes
Tightness norm: IP 65
Approval: SAE/ECE-R65, CISPR 25 Class 5
E-approval: Yes

171923 LED Beacon Std pkg 1

Dome: HC-CARGO 171942.

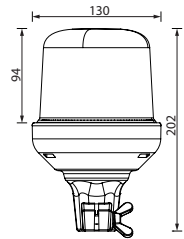

Voltage: 12-24
Amp: 1.2/2.9
Watt: 37

OD: 130 mm
Cable length: 400 mm
Height: 202 mm

Bulb type: 10 LED
Lens type: Polycarbonate
Colour: Blue
Material: Aluminium
Mount.: Standard ISO A - Rod
Flash patterns: 11
Hi impact: Yes
Waterproof: Yes
Tightness norm: IP 65
Approval: SAE/ECE-R65, CISPR 25 Class 5
E-approval: Yes

171931 LED Beacon Std pkg 1

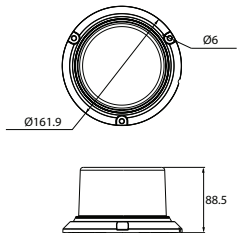

Voltage: 12-36
Amp: 2.9/1.8
Watt: 35/44

OD: 161.9 mm
Cable length: 340 mm
Height: 88.5 mm

Bulb type: 12 LED
Colour: Orange
Mount.: Plan
Flash patterns: 5
Waterproof: Yes
Tightness norm: IP 67
Approval: EMC-R10/ECE-R65
E-approval: Yes



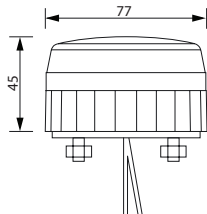





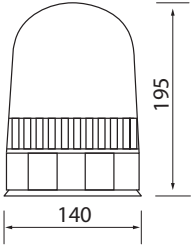

171957 LED Beacon Std pkg 1

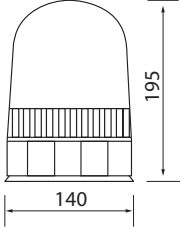

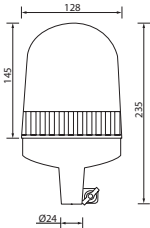
Voltage: 10-100
Amp: 0.1
Watt: 1.2

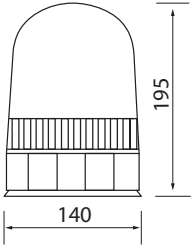
OD: 77 mm
Cable length: 410 mm
Height: 45 mm
Dist. mount. holes: 45 mm

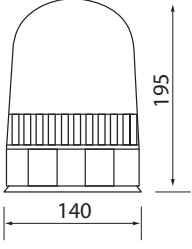
Bulb type: 12 LED
Lens type: Polycarbonate
Colour: Orange
Material: Polycarbonate
Mount.: Plan
Flash patterns: 4
Hi impact: Yes
Tightness norm: IP 67
Approval: CE/EMC
E-approval: No

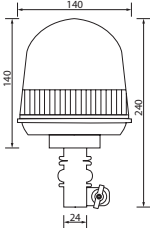
172027 LED Beacon		Std pkg 1		Dome: HC-CARGO 170945.	
		Voltage: 10-30 Amp: 1.5 Watt: 18	OD: 140 mm Cable length: 200 mm Height: 195 mm Dist. mount. holes: 107 mm	Bulb type: 80 LED Lens type: Polycarbonate Colour: Orange Material: Plastic/nylon/rubber Mount.: Lighter Socket Base: Magnetic/vacuum Flash patterns: 3 Hi impact: Yes Coiled cable incl.: Yes Tightness norm: IP 65 Approval: ECE-R65 E-approval: Yes	
172028 LED Beacon Std pkg 1 Dome: HC-CARGO 170945.					
		Voltage: 10-30 Amp: 1.5 Watt: 18	OD: 140 mm Cable length: 95 mm Height: 195 mm Dist. mount. holes: 107 mm	Bulb type: 80 LED Lens type: Polycarbonate Colour: Orange Material: Plastic/nylon/rubber Mount.: Plan Base: Vacuum Flash patterns: 3 Hi impact: Yes Tightness norm: IP 65 Approval: ECE-R65 E-approval: Yes	
172029 LED Beacon Std pkg 1 Dome: HC-CARGO 170945.					
		Voltage: 10-30 Amp: 1.5 Watt: 18	OD: 128 mm Height: 235 mm	Bulb type: 80 LED Lens type: Polycarbonate Colour: Orange Material: Plastic/nylon/rubber Mount.: Standard ISO A - Rod Base: Rigid Flash patterns: 3 Hi impact: Yes Tightness norm: IP 65 Approval: ECE-R65 E-approval: Yes	
172030 LED Beacon Std pkg 1 Dome: HC-CARGO 170945. w/ battery. For rotating pattern: 2 hrs, For triple flash pattern: 2.5 ~ 3 hrs, For single flash pattern: 7-8 hrs.					
		Voltage: 12 Amp: 1.5 Watt: 18	OD: 140 mm Height: 195 mm Dist. mount. holes: 107 mm	Bulb type: 80 LED Lens type: Polycarbonate Colour: Orange Material: Plastic/nylon/rubber Mount.: Plan Base: Magnetic/vacuum Flash patterns: 3 Hi impact: Yes Wall charger 230 V: Yes Tightness norm: IP 65 Approval: ECE-R65 E-approval: Yes	
172075 LED Beacon UK Version Std pkg 1		Servicing: UK - Visit our web catalogue for further information			
Dome: HC-CARGO 170945. w/ battery.					
		Voltage: 10-30 Amp: 1.5 Watt: 18	OD: 140 mm Height: 195 mm Dist. mount. holes: 107 mm	Bulb type: 80 LED Lens type: Polycarbonate Colour: Orange Material: Plastic/nylon/rubber Mount.: Plan Base: Magnetic/vacuum Flash patterns: 3 Hi impact: Yes Tightness norm: IP 65 Approval: ECE-R65 E-approval: Yes Alternativ no.: 172030UK	
172099 LED Beacon Std pkg 1		Dome: HC-CARGO 172110.			
		Voltage: 10-30 Amp: 0.4-1.4 Watt: 9	OD: 140 mm Height: 240 mm	Bulb type: 40 LED Lens type: Polycarbonate Colour: Orange Material: Plastic/nylon/rubber Mount.: Standard ISO A - Rod Base: Flexible Flash patterns: 3 Tightness norm: IP 65 Approval: ECE-R65 E-approval: Yes	

172100 LED Beacon Std pkg 1

Dome: HC-CARGO 172110.

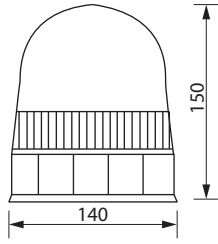

Voltage: 10-30
Amp: 0.4-1.4
Watt: 9

OD: 140 mm
Cable length: 95 mm
Height: 150 mm
Dist. mount. holes:
107 mm

Bulb type: 40 LED
Lens type: Polycarbonate
Colour: Orange
Material: Plastic/nylon/rubber
Mount.: Plan
Flash patterns: 3
Tightness norm: IP 65
Approval: ECE-R65
E-approval: Yes

172101 LED Beacon Std pkg 1

Max. 120 kph. Dome: HC-CARGO 172110.

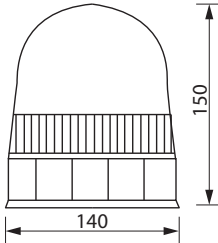

Voltage: 10-30
Amp: 0.4-1.4
Watt: 9

OD: 140 mm
Cable length: 180 mm
Height: 150 mm
Dist. mount. holes:
107 mm

Bulb type: 40 LED
Lens type: Polycarbonate
Colour: Orange
Material: Plastic/nylon/rubber
Mount.: Plan
Base: Magnetic/vacuum
Flash patterns: 3
Coiled cable incl.: Yes
Tightness norm: IP 65
Approval: ECE-R65
E-approval: Yes

172114 LED Beacon Std pkg 1

Dome: HC-CARGO 171590.

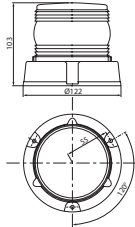

Voltage: 10-100
Amp: 0.3
Watt: 5.5

OD: 122 mm
Height: 103 mm
Temp.: -20 - +55 °C

Bulb type: 9 LED
Lens type: PMMA
Colour: Orange
Mount.: Standard ISO B2 (and B1) - Base
Flash patterns: 1
Tightness norm: IP 54
Approval: CE/EMC
E-approval: No

172145 LED Beacon Std pkg 1

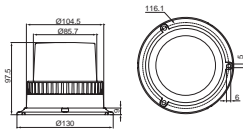

Voltage: 11-110
Amp: 0.4
Watt: 3

OD: 130 mm
Cable length: 400 mm
Height: 97.5 mm

Bulb type: 3 LED
Lens type: Polycarbonate
Colour: Orange
Mount.: Plan
Flash patterns: 5
Hi impact: Yes
Coiled cable incl.: No
Approval: SAE/ECE
E-approval: No
Alternativ no.: 171674

172183 LED Beacon Std pkg 1

Turn on and off on yellow wire to change the flashing pattern.

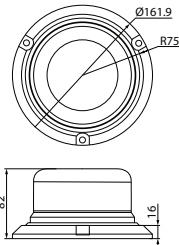

Voltage: 12-36
Watt: 70

OD: 161.9 mm
Cable length: 340 mm
Height: 82 mm
Temp.: -30 - +50 °C

Bulb type: 12 LED
Lens type: Polycarbonate
Colour: Orange
Material: Aluminium
Mount.: Plan
Flash patterns: 5
Hi impact: Yes
Waterproof: Yes
Tightness norm: IP 69K
Approval: EMC-R10/ECE-R65
E-approval: Yes

172184 LED Beacon Std pkg 1



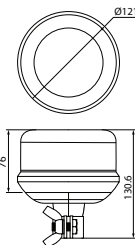





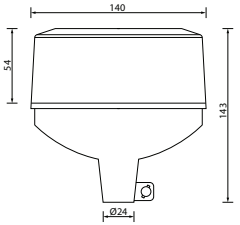

Turn on and off within 5 seconds to change the flashing pattern.

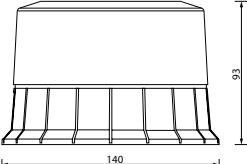

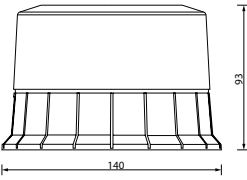
Voltage: 12-36
Watt: 70

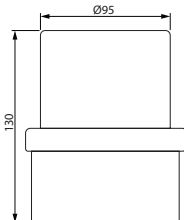
OD: 121.7 mm
Height: 130.6 mm
Temp.: -30 - +50 °C

Bulb type: 12 LED
Lens type: Polycarbonate
Colour: Orange
Material: Aluminium
Mount.: Standard ISO A - Rod
Flash patterns: 2
Hi impact: Yes
Waterproof: Yes
Tightness norm: IP 69K
Approval: EMC-R10/ECE-R65
E-approval: Yes

		EL. SPECIFICATIONS	DIMENSIONS	ADDITIONAL SPECIFICATIONS
172209 LED Beacon	Std pkg 1	  <p>Voltage: 10-30 Amp: 0.9 Watt: 24</p>	<p>OD: 140 mm Height: 143 mm Temp.: -30 - +60 °C</p>	<p>Bulb type: 8 LED Lens type: Polycarbonate Colour: Orange Mount.: Standard ISO A - Rod Base: Flexible Flash patterns: 3 Tightness norm: IP 65 Approval: CE/EMC/ECE-R65 E-approval: Yes</p>
172210 LED Beacon	Std pkg 1	  <p>Voltage: 10-30 Amp: 0.9 Watt: 24</p>	<p>OD: 140 mm Cable length: 200 mm Height: 93 mm Temp.: -30 - +60 °C</p>	<p>Bulb type: 8 LED Lens type: Polycarbonate Colour: Orange Mount.: Plan Base: Magnetic Flash patterns: 3 Tightness norm: IP 65 Approval: ECE-R10/ECE-R65 E-approval: Yes</p>
172211 LED Beacon	Std pkg 1	  <p>Voltage: 10-30 Amp: 0.9 Watt: 24</p>	<p>OD: 140 mm Height: 93 mm Temp.: -30 - +60 °C</p>	<p>Bulb type: 8 LED Lens type: Polycarbonate Colour: Orange Mount.: Plan Base: Magnetic Flash patterns: 3 Tightness norm: IP 65 Approval: ECE-R10/ECE-R65 E-approval: Yes</p>
172221 LED Beacon	Std pkg 1	<p>2xD batteries: HC-CARGO 200741.</p>  	<p>OD: 95 mm Height: 130 mm</p>	<p>Bulb type: 8 LED Colour: Orange Material: PC/ABS Mount.: Plan Base: Magnetic Flash patterns: 1 Waterproof: Yes Tightness norm: IP 65 E-approval: No</p>
SPARE PARTS				
170945 Dome	Std pkg 1	 	<p>OD: 127 mm Height: 148 mm</p>	<p>Service: HC-CARGO 170830, 171019, 171577, 171587, 171588, 171793, 172027, 172028, 172029, 172030, 172075</p> <p>Lens type: PMMA/ACRYL Colour: Orange Model: Astral E-approval: Yes Alternativ no.: 171463</p>
171941 Dome	Std pkg 1		<p>OD: 130 mm Height: 94 mm</p>	<p>Service: HC-CARGO 171918, 171919, 171920</p> <p>Lens type: Polycarbonate Colour: Orange</p>
171942 Dome	Std pkg 1		<p>OD: 130 mm Height: 94 mm</p>	<p>Service: HC-CARGO 171921, 171922, 171923</p> <p>Lens type: Polycarbonate Colour: Blue</p>

ROTATING BEACONS XENON
170650 Xenon Beacon Std pkg 1

Beacon Socket: HC-CARGO 170653. Base Plate: HC-CARGO 170528. Xenon Bulb: HC-CARGO 170654.

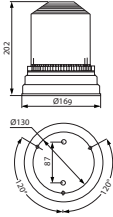

 Bulb incl.: Yes
 Voltage: 12
 Amp: 1.5

 OD: 169 mm
 Height: 202 mm

 Bulb type: LX10J
 Lens type: Polycarbonate
 Colour: Orange
 Model: XENON FT6 AG ELECTRONIC
 Mount.: Standard ISO B2 (and B1) - Base
 Hi impact: Yes
 Tightness norm: IP 55
 E-approval: Yes

170651 Xenon Beacon Std pkg 1

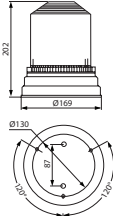
Beacon Socket: HC-CARGO 170653. Base Plate: HC-CARGO 170528. Xenon Bulb: HC-CARGO 170654.



 Bulb incl.: Yes
 Voltage: 24
 Amp: 1.5

 OD: 169 mm
 Height: 202 mm

 Bulb type: LX10J
 Lens type: PMMA/ACRYL
 Colour: Orange
 Model: XENON FT6 AG ELECTRONIC
 Mount.: Standard ISO B2 (and B1) - Base
 Tightness norm: IP 55
 E-approval: Yes

170680 Xenon Beacon Std pkg 1

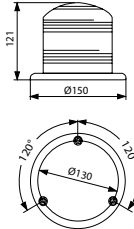
Xenon Bulb: HC-CARGO 171376. Base Plate: HC-CARGO 170528.



 Bulb incl.: Yes
 Voltage: 10-100
 Amp: 200/50
 mAmpere

 OD: 150 mm
 Height: 121 mm

 Bulb type: LX1J
 Lens type: Polycarbonate
 Colour: Orange
 Material: Polycarbonate
 Model: FLASH ELEV
 Mount.: Standard ISO B2 (and B1) - Base
 Base: Rigid
 Hi impact: Yes
 Tightness norm: IP 54
 Approval: CE/EMC
 Alternativ no.: 171005

171005 Xenon Beacon Std pkg 1

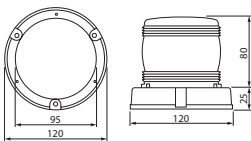
w/ Xenon tube. Dome: HC-CARGO 171590. Xenon Bulb: HC-CARGO 170654.



 Bulb incl.: Yes
 Voltage: 10-100

 OD: 120 mm
 Height: 105 mm

 Bulb type: LX10J
 Lens type: PMMA/ACRYL
 Colour: Orange
 Model: TYPE TRASPOT XENON
 Mount.: Standard ISO B2 (and B1) - Base
 Approval: CE/EMC
 Alternativ no.: 170680

171495 Xenon Beacon Std pkg 1

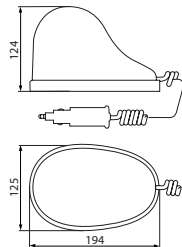
Tested for 200 kmh. Dome: HC-CARGO 171512. Coiled Cable: HC-CARGO 171562.



 Bulb incl.: Yes
 Voltage: 12
 Amp: 1.5

 OD: 125 mm
 Length: 194 mm
 Height: 124 mm

 Bulb type: LX8J
 Lens type: Polycarbonate
 Colour: Orange
 Material: Rubber
 Model: GDO FLASH
 Mount.: 1 magnet
 Base: Magnetic
 Hi impact: Yes
 Coiled cable incl.: Yes
 Tightness norm: IP 55
 Approval: CE
 E-approval: Yes

171497 Xenon Beacon Std pkg 1

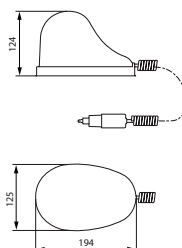
Tested for 200 kmh.

 Bulb incl.: Yes
 Voltage: 12
 Amp: 1.5

 OD: 125 mm
 Length: 194 mm
 Height: 124 mm

 Bulb type: LX8J
 Lens type: Polycarbonate
 Colour: Blue
 Material: Rubber
 Model: GDO FLASH
 Mount.: 1 magnet
 Base: Magnetic
 Hi impact: Yes
 Coiled cable incl.: Yes
 Tightness norm: IP 55
 Approval: CE
 E-approval: Yes

		EL. SPECIFICATIONS	DIMENSIONS	ADDITIONAL SPECIFICATIONS
171540	Xenon Beacon	Std pkg 1		
		Bulb incl.: Yes Voltage: 12 Amp: 1.5	OD: 152 mm Height: 240 mm	Bulb type: LX8J Lens type: Polycarbonate Colour: Orange Model: BOULE FLASH Mount.: Standard ISO A - Rod Base: Flexible Hi impact: Yes Tightness norm: IP 66 E-approval: Yes
171561	Xenon Beacon	Std pkg 1		
w/ Xenon tube. Dome: HC-CARGO 171590.				
		Bulb incl.: Yes Voltage: 10-100	OD: 120 mm Height: 112 mm	Lens type: PMMA/ACRYL Colour: Orange Model: Type TRASPOT Mount.: Standard ISO B2 (and B1) - Base Base: Magnetic Coiled cable incl.: Yes Approval: CE/EMC Alternativ no.: 170680
171614	Xenon Beacon	Std pkg 1		
		Bulb incl.: Yes Voltage: 10-30	OD: 132 mm Height: 210 mm	Bulb type: LX10J Lens type: Polycarbonate Colour: Orange Model: Xenon Mount.: Standard ISO A - Rod Hi impact: Yes E-approval: Yes
171798	Xenon Beacon	Std pkg 1		
		Voltage: 10-100 Watt: 5	OD: 77 mm Height: 45 mm Dist. mount. holes: 45 mm	Bulb type: Xenon Lens type: Polycarbonate Flash rate: 75 min. Colour: Orange Material: Polycarbonate Mount.: Plan Hi impact: Yes Tightness norm: IP 67 Approval: CE
SPARE PARTS				
170654	Xenon Bulb	Std pkg 1	Servicing: HC-CARGO 170650, 170651, 171505, 171005	
		Bulb incl.: Yes Voltage: 12/24 Watt: 16		Bulb type: LX10J Model: XENON FT6 /FLX ELECTRONIC
171376	Xenon Bulb	Std pkg 1	Servicing: HC-CARGO 171498, 170680	
				Bulb type: LX1J Model: FLASH ELEV
171590	Dome	Std pkg 1	Servicing: HC-CARGO 171005, 171561, 172114	
			OD: 95 mm Height: 80 mm	Lens type: PMMA/ACRYL Colour: Orange Model: TRANSPORT XENON Alternativ no.: 170680

ACCESSORIES
170525 Beacon Socket

Std pkg 1

Servicing: HC-CARGO 170490, 171017



 Cable length: 2000 mm
 Height: 28 mm
 Width: 147 mm

 Model: TYPE FT 6
 Mount.: 3 magnets
 Base: Magnetic
 Coiled cable incl.: Yes
 Tightness norm: IP 55

170528 Base Plate

Std pkg 1

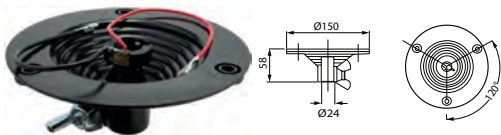
Servicing: HC-CARGO 170491, 170490, 170650, 170651, 171498, 170680

 OD: 150 mm
 Height: 58 mm

 Model: TYPE FT 6
 Mount.: Standard ISO A - Rod

170653 Beacon Socket

Std pkg 1

Servicing: HC-CARGO 170650, 170651, 171466



 Cable length: 2000 mm
 Height: 30 mm
 Width: 168 mm

 Mount.: 3 magnets
 Base: Magnetic
 Coiled cable incl.: Yes
 Tightness norm: IP 55
 E-approval: Yes

FLASH LIGHTS LED
171642 LED Flash, white

Std pkg 1

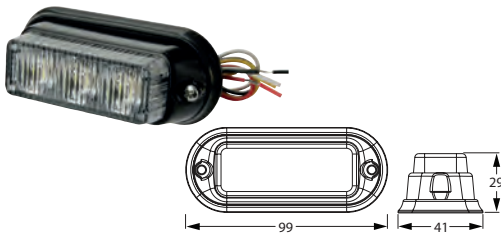
Multi-module synchronization. Bracket: HC-CARGO 171657. Rubber adapter for flush mount: HC-CARGO 171728.

 Voltage: 12/24
 Amp: 0.32/0.17
 Watt: 6

 Length: 99 mm
 Cable length: 200 mm
 Height: 29 mm
 Width: 41 mm

 Bulb type: 3 LED
 Lens type: Polycarbonate
 Colour: White
 Material: Aluminium
 Flash patterns: 12
 Waterproof: Yes
 Tightness norm: IP 67
 Approval: CE/EMC

171644 LED Flash, blue

Std pkg 1

Multi-module synchronization. Bracket: HC-CARGO 171657. Rubber adapter for flush mount: HC-CARGO 171728.

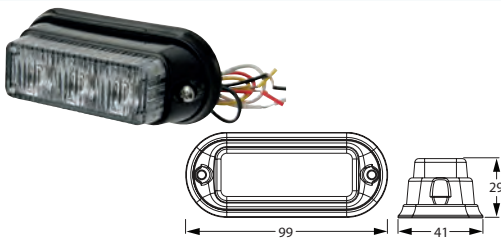
 Voltage: 12/24
 Amp: 0.32/0.17
 Watt: 6

 Length: 99 mm
 Cable length: 200 mm
 Height: 29 mm
 Width: 41 mm

 Bulb type: 3 LED
 Lens type: Polycarbonate
 Colour: Blue
 Material: Aluminium
 Flash patterns: 12
 Waterproof: Yes
 Tightness norm: IP 67
 Approval: CE/EMC

171646 LED Flash, white

Std pkg 1

Multi-module synchronization. Bracket: HC-CARGO 171658. Rubber adapter for flush mount: HC-CARGO 171675.

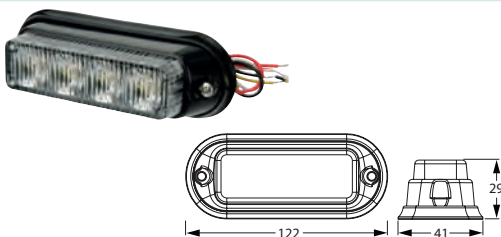
 Voltage: 12/24
 Amp: 0.64/0.32
 Watt: 8

 Length: 122 mm
 Cable length: 200 mm
 Height: 29 mm
 Width: 41 mm

 Bulb type: 4 LED
 Lens type: Polycarbonate
 Colour: White
 Material: Aluminium
 Flash patterns: 19
 Waterproof: Yes
 Tightness norm: IP 67
 Approval: CE/EMC

171648 LED Flash, blue Std pkg 1 <i>Multi-module synchronization. Bracket: HC-CARGO 171658. Rubber adapter for flush mount: HC-CARGO 171675.</i>		
	Voltage: 12/24 Amp: 0.64/0.32 Watt: 8	Length: 122 mm Cable length: 200 mm Height: 29 mm Width: 41 mm
Bulb type: 4 LED Lens type: Polycarbonate Colour: Blue Material: Aluminium Flash patterns: 19 Waterproof: Yes Tightness norm: IP 67 Approval: CE/EMC		
171661 LED Flash, amber Std pkg 1 <i>Multi-module synchronization. Bracket: HC-CARGO 171663.</i>		
	Voltage: 12/24 Amp: 0.52 Watt: 6	Length: 116 mm Cable length: 200 mm Height: 23.8 mm Width: 47 mm
Bulb type: 4 LED Lens type: Polycarbonate Colour: Orange Material: Aluminium Flash patterns: 12 Waterproof: Yes Tightness norm: IP 67 Approval: SAE/CE		
171662 LED Flash, amber Std pkg 1 <i>Multi-module synchronization. Bracket: HC-CARGO 171664.</i>		
	Voltage: 12/24 Amp: 0.46/0.24 Watt: 6	Length: 148 mm Cable length: 200 mm Height: 23 mm Width: 47 mm
Bulb type: 6 LED Lens type: Polycarbonate Colour: Orange Material: Aluminium Flash patterns: 19 Waterproof: Yes Tightness norm: IP 67 Approval: SAE/CE		
171813 LED Flash, blue Std pkg 1 <i>Fits w/ rubber adapter for flush mount: HC-CARGO 171817.</i>		
	Voltage: 12/24 Amp: 0.39/0.2 Watt: 0.48	Length: 127.5 mm Cable length: 200 mm Height: 17.2 mm Width: 27.8 mm
Bulb type: 6 LED Lens type: Polycarbonate Colour: Blue Material: Aluminium Flash patterns: 5 Waterproof: Yes Tightness norm: IP 67 Approval: SAE/ECE-R65 E-approval: Yes		
171814 LED Flash, amber Std pkg 1 <i>Fits w/ rubber adapter for flush mount: HC-CARGO 171817.</i>		
	Voltage: 12/24 Amp: 0.39/0.2 Watt: 0.48	Length: 127.5 mm Cable length: 970 mm Height: 17.2 mm Width: 27.8 mm
Bulb type: 6 LED Lens type: Polycarbonate Colour: Orange Material: Aluminium Flash patterns: 5 Waterproof: Yes Tightness norm: IP 67 Approval: SAE/ECE-R65 E-approval: Yes		
171904 LED Flash, amber Std pkg 1 <i>Multi-module synchronization. Bracket: HC-CARGO 171658. Rubber adapter for flush mount: HC-CARGO 171675.</i>		
	Voltage: 12-24 Amp: 0.32/0.17 Watt: 4.1	Length: 122 mm Cable length: 200 mm Height: 29.4 mm Width: 41 mm
Bulb type: 4 LED Lens type: Polycarbonate Colour: Orange Material: Aluminium Flash patterns: 23 Waterproof: Yes Tightness norm: IP 67 Approval: SAE/ECE-R65 E-approval: Yes		

171905 LED Flash, amber Std pkg 1

Multi-module synchronization. Bracket: HC-CARGO 171657. Rubber adapter for flush mount: HC-CARGO 171728.

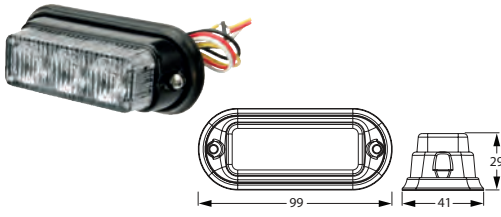

Voltage: 12-24
Amp: 0.32/0.16
Watt: 4.1

Length: 99 mm
Cable length: 200 mm
Height: 29 mm
Width: 41 mm

Bulb type: 3 LED
Lens type: Polycarbonate
Colour: Orange
Material: Aluminium
Flash patterns: 12
Waterproof: Yes
Tightness norm: IP 67
Approval: SAE/ECE-R65
E-approval: Yes

171906 LED Flash, amber Std pkg 1

Multi-module synchronization. Bracket: HC-CARGO 171908. Rubber adapter for flush mount: HC-CARGO 171907.

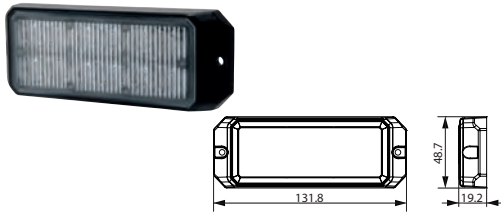

Voltage: 12-24
Amp: 0.75/0.38
Watt: 9

Length: 131.8 mm
Cable length: 200 mm
Height: 48.7 mm
Width: 19.2 mm

Bulb type: 12 LED
Lens type: Polycarbonate
Colour: Orange
Material: Aluminium
Flash patterns: 25
Waterproof: Yes
Tightness norm: IP 67
Approval: SAE/ECE-R65
E-approval: Yes

171926 LED Flash, amber Std pkg 1

Fits w/ rubber adapter for flush mount: HC-CARGO 171817.

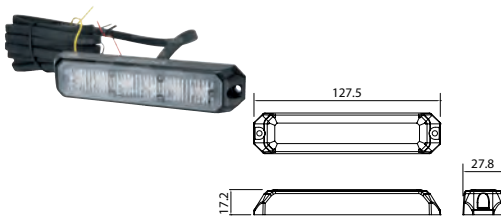

Voltage: 12-24
Amp: 0.39/0.2
Watt: 9.6

Length: 127.5 mm
Cable length: 3000 mm
Height: 17.2 mm
Width: 27.8 mm

Bulb type: 6 LED
Lens type: Polycarbonate
Colour: Orange
Material: Aluminium
Mount.: 3 m ADR Cable
Flash patterns: 5
Waterproof: Yes
Tightness norm: IP 67
Approval: SAE/ECE-R65
E-approval: Yes

171933 LED Flash, amber Std pkg 1

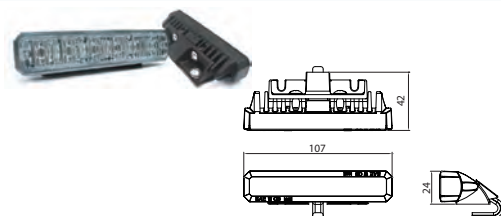

Voltage: 12-24
Amp: 0.55/0.26
Watt: 9.6

Length: 107 mm
Cable length: 970 mm
Height: 24 mm
Width: 42 mm

Bulb type: 6 LED
Lens type: Polycarbonate
Colour: Orange
Material: Aluminium
Flash patterns: 19
Waterproof: Yes
Tightness norm: IP 67
Approval: SAE/ECE-R65
E-approval: Yes
Alternativ no.: 171814

171943 LED Flash, white Std pkg 1

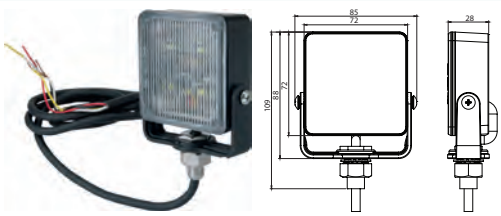

Voltage: 12/24
Amp: 0.27-0.13
Watt: 3.5

Length: 109 mm
Cable length: 1200 mm
Height: 28 mm
Width: 72 mm

Bulb type: LED
Lens type: Polycarbonate
Colour: White
Material: Aluminium
Flash patterns: 19
Hi impact: Yes
Coiled cable incl.: No
Waterproof: Yes
Approval: SAE/CE

172011 LED Flash, amber Std pkg 1

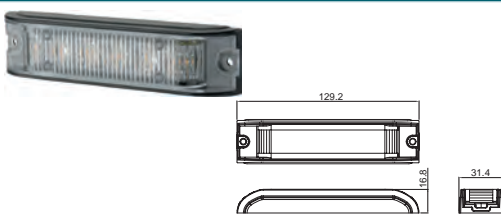

Voltage: 12/24
Amp: 0.5/0.25
Watt: 6

Length: 129.2 mm
Cable length: 250 mm
Height: 31.4 mm
Width: 16.8 mm

Bulb type: 6 LED
Lens type: Polycarbonate
Colour: Orange
Material: Aluminium
Flash patterns: 15
Waterproof: Yes
Tightness norm: IP 67
Approval: ECE-R65
E-approval: Yes



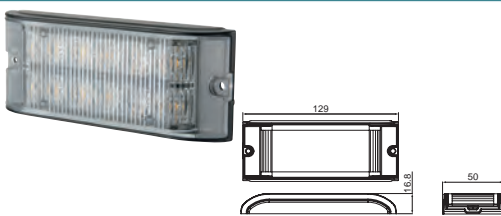





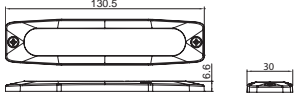

172012 LED Flash, amber Std pkg 1

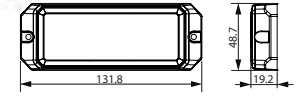

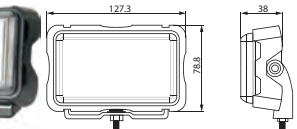
Voltage: 12/24
Amp: 0.88/0.44
Watt: 10.5

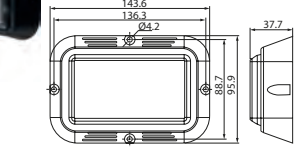
Length: 129 mm
Cable length: 250 mm
Height: 16.8 mm
Width: 50 mm

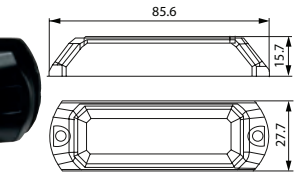
Bulb type: 12 LED
Lens type: Polycarbonate
Colour: Orange
Material: Aluminium
Flash patterns: 15
Waterproof: Yes
Tightness norm: IP 67
Approval: ECE-R65
E-approval: Yes

EL. SPECIFICATIONS		DIMENSIONS	ADDITIONAL SPECIFICATIONS
172013 LED Flash, amber	Std pkg 1		
	Voltage: 12/24 Amp: 0.25/0.125 Watt: 3	Length: 130.5 mm Cable length: 200 mm Height: 6.6 mm Width: 30 mm	Bulb type: 6 LED Lens type: Polycarbonate Colour: Orange Material: Aluminium Flash patterns: 23 Waterproof: Yes Tightness norm: IP 67 Approval: SAE/CE E-approval: Yes
			
172076 LED Flash, amber	Std pkg 1		
<i>Multi-module synchronization. Bracket: HC-CARGO 171908. Rubber adapter for flush mount: HC-CARGO 171907.</i>			
	Voltage: 12-24 Amp: 0.75/0.38 Watt: 9	Length: 131.8 mm Cable length: 2000 mm Height: 48.7 mm Width: 19.2 mm	Bulb type: 12 LED Lens type: Polycarbonate Colour: Orange Material: Aluminium Flash patterns: 25 Waterproof: Yes Tightness norm: IP 67 Approval: SAE/ECE-R65 E-approval: Yes
			
172085 LED Flash, amber	Std pkg 1		
	Voltage: 12-36 Amp: 1.5/0.8	Length: 127.3 mm Cable length: 1800 mm Height: 78.8 mm Width: 38 mm	Bulb type: 6 LED Lens type: Polycarbonate Colour: Orange Material: Aluminium Flash patterns: 1 Tightness norm: IP 67 Approval: ECE-R10/ECE-R65 E-approval: Yes
			
172086 LED Flash, amber	Std pkg 1		
	Voltage: 12-36 Amp: 1.5/0.8	Length: 143.6 mm Cable length: 1800 mm Height: 95.9 mm Width: 37.7 mm	Bulb type: 6 LED Lens type: Polycarbonate Colour: Orange Material: Aluminium Mount.: Plan Flash patterns: 1 Tightness norm: IP 67 Approval: ECE-R10/ECE-R65 E-approval: Yes
			
172087 LED Flash, amber	Std pkg 1		
<i>Rubber Adapter for Flush Mount: HC-CARGO 171816.</i>			
	Voltage: 12-24 Amp: 1	Length: 85.6 mm Cable length: 970 mm Height: 15.7 mm Width: 27.7 mm	Bulb type: 3 LED Lens type: Polycarbonate Colour: Orange Material: Aluminium Flash patterns: 5 Waterproof: Yes Tightness norm: IP 67 Approval: SAE/ECE-R65 E-approval: Yes Alternativ no.: 171815
			
172089 LED Safety Flash	Std pkg 1		
<i>w/ hook. Battery: 3x HC-CARGO 200738.</i>			
		OD: 105 mm Height: 35 mm	Bulb type: 12 LED Colour: Orange Mount.: 1 magnet Flash patterns: 9 Tightness norm: IP 67 Approval: CE/EMC
172090 LED Safety Flash	Std pkg 1		
<i>Rechargeable.</i>			
	Voltage: 12/24 Amp: 1.5	OD: 120 mm Height: 35 mm Temp.: -40 - +60 °C	Bulb type: 16 LED Colour: Orange Mount.: 1 magnet Flash patterns: 9 Wall charger 230 V: Yes Charger 12 V: Yes Tightness norm: IP 67 Approval: CE/EMC

172091 LED Safety Flash Std pkg 1

Rechargeable. Suitcase w/ 6 pcs.

 Voltage: 12/24
Amp: 1.5

 OD: 120 mm
Height: 35 mm
Temp.: -40 - +60 °C

 Bulb type: 16 LED
Colour: Orange
Mount.: 1 magnet
Flash patterns: 9
Wall charger 230 V: Yes
Charger 12 V: Yes
Tightness norm: IP 67
Approval: CE/EMC

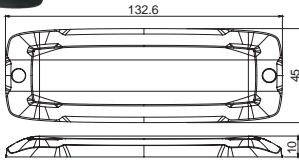
172108 LED Flash, blue/orange Std pkg 1

 Voltage: 12-24
Amp: 0.88/0.44
Watt: 10.5

 Length: 132.6 mm
Cable length: 250 mm
Height: 45 mm
Width: 10 mm

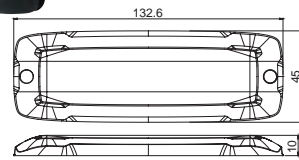
 Bulb type: 12 LED
Lens type: Polycarbonate
Colour: Blue/Orange
Material: Aluminium
Mount.: Plan
Flash patterns: 16
Waterproof: Yes
Tightness norm: IP 67
Approval: EMC/ECE-R65
E-approval: Yes

172109 LED Flash, amber Std pkg 1

 Voltage: 12-24
Amp: 0.88/0.44
Watt: 10.5

 Length: 132.6 mm
Cable length: 250 mm
Height: 45 mm
Width: 10 mm

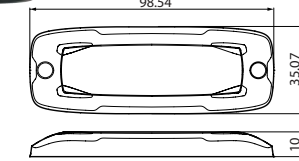
 Bulb type: 12 LED
Lens type: Polycarbonate
Colour: Orange
Material: Aluminium
Mount.: Plan
Flash patterns: 16
Waterproof: Yes
Tightness norm: IP 67
Approval: EMC/ECE-R65
E-approval: Yes

172112 LED Flash, amber Std pkg 1

 Voltage: 12-24
Amp: 0.88/0.44
Watt: 10.5

 Length: 98.54 mm
Cable length: 250 mm
Height: 35.07 mm
Width: 10 mm

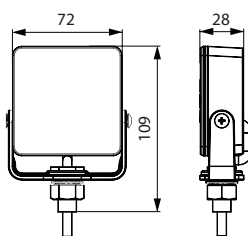
 Bulb type: 6 LED
Lens type: Polycarbonate
Colour: Orange
Material: Aluminium
Mount.: Plan
Flash patterns: 16
Waterproof: Yes
Tightness norm: IP 68
Approval: EMC/ECE-R65
E-approval: Yes

172113 LED Flash, amber Std pkg 1

 Voltage: 12/24
Amp: 0.27-0.13
Watt: 3.5

 Length: 109 mm
Cable length: 1200 mm
Height: 28 mm
Width: 72 mm

 Bulb type: LED
Lens type: Polycarbonate
Colour: Orange
Material: Aluminium
Flash patterns: 19
Coiled cable incl.: No
Waterproof: Yes
Tightness norm: IP 67
Approval: SAE/ECE-R65

172118 LED Safety Flash UK Std pkg 1

UK version. Rechargeable. Suitcase w/ 6 pcs.

 Voltage: 12/24
Amp: 1.5

 OD: 120 mm
Height: 35 mm
Temp.: -40 - +60 °C

 Bulb type: 16 LED
Colour: Orange
Mount.: 1 magnet
Flash patterns: 9
Wall charger 230 V: Yes
Charger 12 V: Yes
Tightness norm: IP 67
Approval: CE/EMC

		EL. SPECIFICATIONS	DIMENSIONS	ADDITIONAL SPECIFICATIONS
172121 LED Safety Flash UK UK version. Rechargeable.		Voltage: 12/24 Amp: 1.5	OD: 120 mm Height: 35 mm Temp.: -40 - +60 °C	Bulb type: 16 LED Colour: Orange Mount.: 1 magnet Flash patterns: 9 Wall charger 230 V: Yes Charger 12 V: Yes Tightness norm: IP 67 Approval: CE/EMC
172122 LED Flash, amber Std pkg 1		Voltage: 12/24 Amp: 0.24/0.12 Watt: 2.82	Cable length: 200 mm Height: 17 mm Dist. mount. holes: 32.5 mm Width: 46.7 mm	Bulb type: 3 LED Colour: Orange Mount.: Plan Flash patterns: 12 Tightness norm: IP 67 Approval: SAE/CE
172123 LED Flash, blue Mounting Bracket: HC-CARGO 172125.		Voltage: 12/24 Amp: 0.24/0.12 Watt: 2.85	Cable length: 200 mm Height: 39 mm Width: 36 mm	Bulb type: 3 LED Colour: Blue Mount.: Built-in Flash patterns: 16 Tightness norm: IP 67 Approval: SAE/ECE-R65 E-approval: Yes
172124 LED Flash, amber Mounting Bracket: HC-CARGO 172125.		Voltage: 12/24 Amp: 0.24/0.12 Watt: 2.85	Cable length: 200 mm Height: 39 mm Width: 36 mm	Bulb type: 3 LED Colour: Orange Mount.: Built-in Flash patterns: 16 Tightness norm: IP 67 Approval: SAE/ECE-R65 E-approval: Yes
172137 LED Flash, amber Multi-module synchronization.		Voltage: 12-24 Amp: 1.14/0.57 Watt: 13	Length: 129.2 mm Cable length: 250 mm Height: 15.79 mm Width: 27.2 mm	Bulb type: 6 LED Colour: Orange Material: Aluminium Flash patterns: 23 Tightness norm: IP 67 Approval: SAE/ECE E-approval: Yes
172139 LED Flash, amber Multi-module synchronization.		Voltage: 12-24 Amp: 1.14/0.57 Watt: 13	Length: 96.8 mm Cable length: 200 mm Height: 34.5 mm Width: 35.9 mm	Bulb type: 6 LED Colour: Orange Material: Aluminium Flash patterns: 16 Tightness norm: IP 67 Approval: SAE/ECE E-approval: Yes

172140 LED Flash, blue Std pkg 1

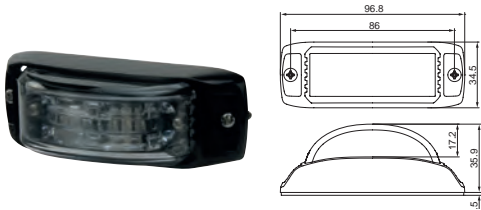
Multi-module synchronization.

 Voltage: 12-24
 Amp: 1.14/0.57
 Watt: 13

 Length: 96.8 mm
 Cable length: 200 mm
 Height: 34.5 mm
 Width: 35.9 mm

 Bulb type: 6 LED
 Colour: Blue
 Material: Aluminium
 Flash patterns: 16
 Tightness norm: IP 67
 Approval: SAE/ECE
 E-approval: Yes

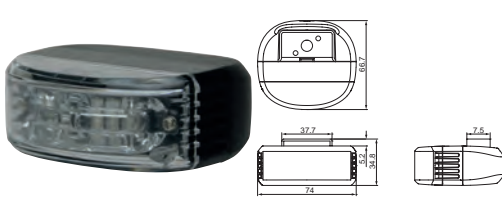
172141 LED Flash, blue Std pkg 1

Multi-module synchronization.

 Voltage: 12-24
 Amp: 1.14/0.57
 Watt: 13

 Length: 66.7 mm
 Cable length: 200 mm
 Height: 34.8 mm
 Width: 7.5 mm

 Bulb type: 6 LED
 Colour: Blue
 Material: Aluminium
 Flash patterns: 16
 Tightness norm: IP 67
 Approval: SAE/ECE
 E-approval: Yes

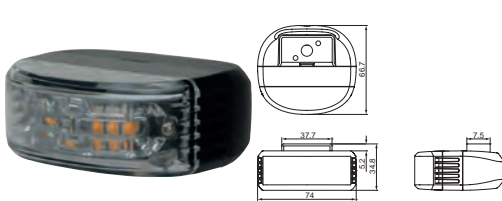
172142 LED Flash, amber Std pkg 1

Multi-module synchronization.

 Voltage: 12-24
 Amp: 1.14/0.57
 Watt: 13

 Length: 66.7 mm
 Cable length: 200 mm
 Height: 34.8 mm
 Width: 7.5 mm

 Bulb type: 6 LED
 Colour: Orange
 Material: Aluminium
 Flash patterns: 16
 Tightness norm: IP 67
 Approval: SAE/ECE
 E-approval: Yes

172203 LED Flash, amber Std pkg 1

 Voltage: 12/24
 Amp: 1.35/0.75
 Watt: 18

 Length: 132 mm
 Cable length: 250 mm
 Height: 18.8 mm
 Width: 50 mm

 Bulb type: 24 LED
 Colour: Amber/Amber
 Mount.: Plan
 Flash patterns: 14
 Tightness norm: IP 68
 Approval: ECE-R65
 E-approval: Yes

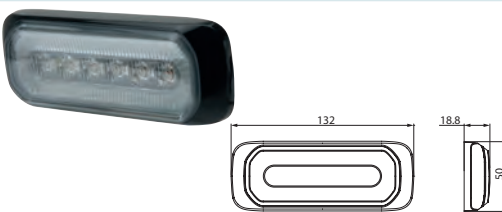
172204 LED Flash, amber/red Std pkg 1

 Voltage: 12/24
 Amp: 1.35/0.75
 Watt: 18

 Length: 132 mm
 Cable length: 250 mm
 Height: 18.8 mm
 Width: 50 mm

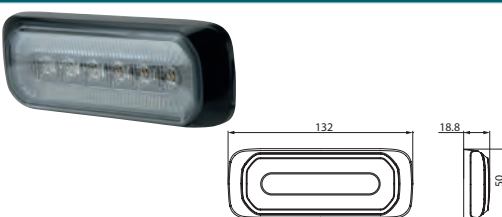
 Bulb type: 24 LED
 Colour: Amber/Red
 Mount.: Plan
 Flash patterns: 14
 Tightness norm: IP 68
 Approval: ECE-R65
 E-approval: Yes

172205 LED Flash, amber/white Std pkg 1

 Voltage: 12/24
 Amp: 1.35/0.75
 Watt: 18

 Length: 132 mm
 Cable length: 250 mm
 Height: 18.8 mm
 Width: 50 mm

 Bulb type: 24 LED
 Colour: Orange/white
 Mount.: Plan
 Flash patterns: 14
 Tightness norm: IP 68
 Approval: ECE-R65
 E-approval: Yes



172223 LED Flash Std pkg 1

 Voltage: 12/24
 Amp: 1.35/0.75
 Watt: 18

 Length: 132 mm
 Cable length: 250 mm
 Height: 18.8 mm
 Width: 50 mm

 Bulb type: 24 LED
 Colour: Blue/Orange
 Mount.: Plan
 Flash patterns: 14
 Tightness norm: IP 68
 Approval: ECE-R65
 E-approval: Yes

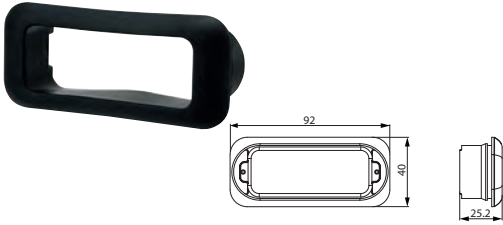
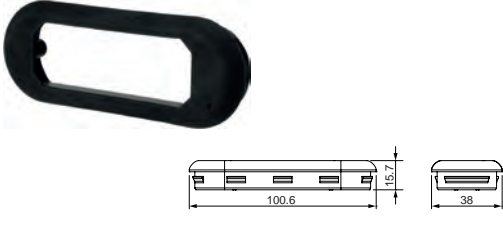
EL. SPECIFICATIONS		DIMENSIONS	ADDITIONAL SPECIFICATIONS
172224 LED Flash Std pkg 1			
 	Voltage: 12/24 Amp: 1.35/0.75 Watt: 18	Length: 132 mm Cable length: 250 mm Height: 18.8 mm Width: 50 mm	Bulb type: 24 LED Colour: Blue/white Mount.: Plan Flash patterns: 14 Tightness norm: IP 68 Approval: ECE-R65 E-approval: Yes
172225 LED Flash Std pkg 1			
 	Voltage: 12/24 Amp: 1.35/0.75 Watt: 18	Length: 132 mm Cable length: 250 mm Height: 18.8 mm Width: 50 mm	Bulb type: 24 LED Colour: Blue/red Mount.: Plan Flash patterns: 14 Tightness norm: IP 68 Approval: ECE-R65 E-approval: Yes
ACCESSORIES			
171657 Mounting Bracket Std pkg 1 Servicing: HC-CARGO 171642, 171644, 171905			
<i>Angled. For single head.</i>			
		Length: 100 mm Thickness: 24 mm Width: 55 mm	
171658 Mounting Bracket Std pkg 1 Servicing: HC-CARGO 171646, 171648, 171904			
<i>Angled. For single head.</i>			
		Length: 123 mm Thickness: 55 mm Width: 24 mm	
171663 Mounting Bracket Std pkg 1 Servicing: HC-CARGO 171661			
<i>Angled 100°.</i>			
		Length: 153 mm Thickness: 55 mm Width: 25 mm	
171664 Mounting Bracket Std pkg 1 Servicing: HC-CARGO 171662			
<i>Adjustable.</i>			
		Length: 156 mm Thickness: 42 mm Width: 30 mm	
171675 Rubber Adapter for Flush Mount Std pkg 1 Servicing: HC-CARGO 171646, 171648, 171904			
 		Length: 114.4 mm Height: 24.9 mm Width: 40 mm	Colour: Black Material: Rubber

EL. SPECIFICATIONS		DIMENSIONS	ADDITIONAL SPECIFICATIONS
171728 Rubber Adapter for Flush Mount	Std pkg 1	Servicing: HC-CARGO 171641, 171642, 171644, 171905	
		Length: 92 mm Height: 25.2 mm Width: 40 mm	Colour: Black Material: Rubber
171816 Rubber Adapter for Flush Mount	Std pkg 1	Servicing: HC-CARGO 171815, 172087	
		Length: 100.6 mm Height: 15.7 mm Width: 38 mm	Colour: Black Material: Rubber
171817 Rubber Adapter for Flush Mount	Std pkg 1	Servicing: HC-CARGO 171813, 171814, 171926	
		Length: 142 mm Height: 17.5 mm Width: 41 mm	Colour: Black Material: Rubber
171907 Rubber Adapter for Flush Mount	Std pkg 1	Servicing: HC-CARGO 171906, 172076	
		Length: 144 mm Height: 20 mm Width: 61 mm	Colour: Black Material: Rubber
171908 Mounting Bracket	Std pkg 1	Servicing: HC-CARGO 171906, 172076	
<i>Angled. For single head.</i>		Height: 55 mm Width: 135 mm	
			
172125 Mounting Bracket	Std pkg 1	Servicing: HC-CARGO 172123, 172124	
			
172219 Adapter for Flush Mount	Std pkg 1	Servicing: HC-CARGO 172203, 172204, 172205, 172223, 172224, 172225	
		Dist. mount. holes: 120 mm	Colour: Chrome Material: ABS plastic

172220 Rubber Adapter for Flush Mount Std pkg 1 Servicing: HC-CARGO 172203, 172204, 172205, 172223, 172224, 172225

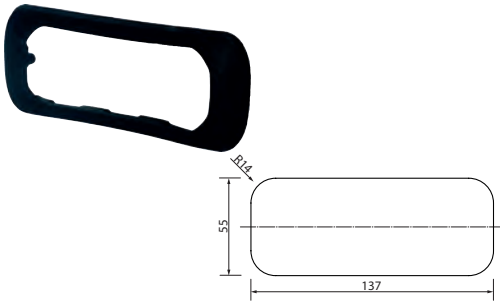

Length: 137 mm
Height: 55 mm
Dist. mount. holes: 120 mm

Colour: Black
Material: Rubber

172222 Adapter for Flush Mount Std pkg 1 Servicing: HC-CARGO 172203, 172204, 172205, 172223, 172224, 172225



Dist. mount. holes: 120 mm

Colour: White
Material: ABS plastic

LIGHT BARS CONVENTIONAL

171681 Mini Light Bar Std pkg 1

Belt for Mini Light Bar: HC-CARGO 171820.



Bulb incl.: Yes
Voltage: 12/24

Length: 400 mm
Height: 134 mm
Width: 180 mm

Bulb type: H1 12 V
Lens type: Polycarbonate
Colour: Orange
Material: ABS plastic
Mount.: Plan
Base: Rigid
Hi impact: Yes
Coiled cable incl.: No
Waterproof: Yes
Tightness norm: IP 56
Approval: CE
E-approval: Yes

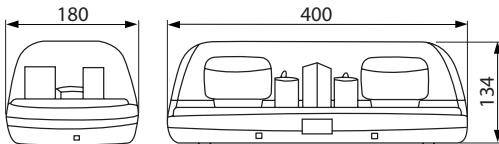

SPARE PARTS

171820 Belt for Mini Light Bar Std pkg 1 Servicing: HC-CARGO 171681

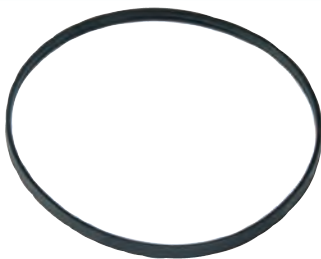

Colour: Black

LIGHT BARS LED

171680 LED Mini Light Bar Std pkg 1

Bracket for permanent mounting: HC-CARGO 171682. Change flash pattern on cigarplug. Can also be connected permanently.



Voltage: 12/24
Amp: 2.6/1.36
Watt: 33.3

Length: 422 mm
Cable length: 4570 mm
Height: 65 mm
Width: 278 mm

Bulb type: 40x1W LED
Lens type: Polycarbonate
Colour: Orange
Model: FALCON
Mount.: Plan
Base: Magnetic/vacuum
Flash patterns: 26
Hi impact: Yes
Waterproof: Yes
Tightness norm: IP 64K
Approval: SAE/CE
E-approval: No

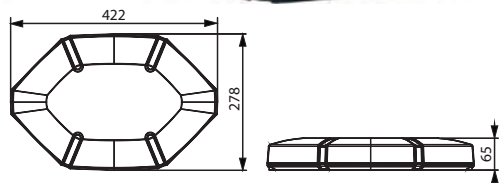

171849 LED Light bar Std pkg 1

Spare Parts: HC-CARGO 171856, 171858. Accessories: HC-CARGO 171781, 171762. Recommended fuse 15 A.

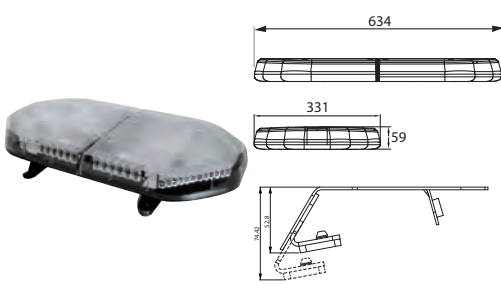

Voltage: 12
Amp: 5.2

Length: 634 mm
Cable length: 5750 mm
Height: 59 mm
Width: 331 mm

Lens type: Polycarbonate
Colour: Orange
Material: Aluminium
Model: 65 cm/24"
Mount.: Plan
Base: Flexible
Flash patterns: 6
Hi impact: Yes
Waterproof: Yes
Tightness norm: IP 66
Approval: SAE/ECE-R65
E-approval: Yes

171850 LED Light bar Std pkg 1

Spare Parts: HC-CARGO 171856, 171858. Accessories: HC-CARGO 171781, 171762. Recommended fuse 20 A.

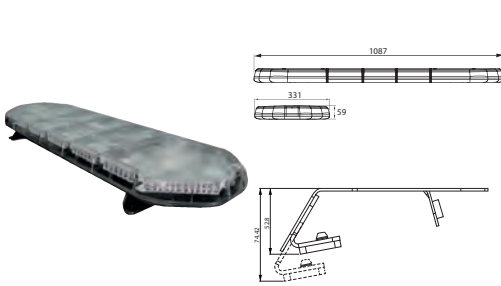

Voltage: 12
Amp: 15

Length: 1087 mm
Cable length: 5750 mm
Height: 59 mm
Width: 331 mm

Lens type: Polycarbonate
Colour: Orange
Material: Aluminium
Model: 110 cm/43"
Mount.: Plan
Base: Flexible
Flash patterns: 21
Hi impact: Yes
Waterproof: Yes
Tightness norm: IP 66
Approval: SAE/ECE-R65
E-approval: Yes
Alternativ no.: 172195

171851 LED Light bar Std pkg 1

Spare Parts: HC-CARGO 171857, 171859. Accessories: HC-CARGO 171865, 171762. Recommended fuse 15 A.

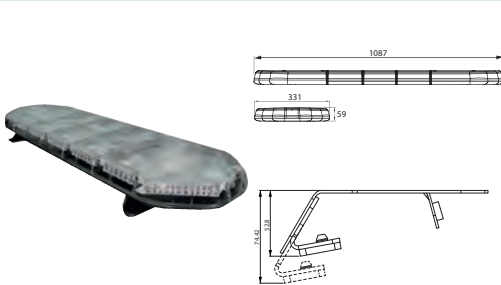

Voltage: 24
Amp: 15

Length: 1087 mm
Cable length: 5750 mm
Height: 59 mm
Width: 331 mm

Lens type: Polycarbonate
Colour: Orange
Material: Aluminium
Model: 110 cm/43"
Mount.: Plan
Base: Flexible
Flash patterns: 21
Hi impact: Yes
Waterproof: Yes
Tightness norm: IP 66
Approval: SAE/ECE-R65
E-approval: Yes
Alternativ no.: 172195

171852 LED Light bar Std pkg 1 Servicing: HC-CARGO 172200

Spare Parts: HC-CARGO 171856, 171858. Accessories: HC-CARGO 171781, 171762. Recommended fuse 25 A.

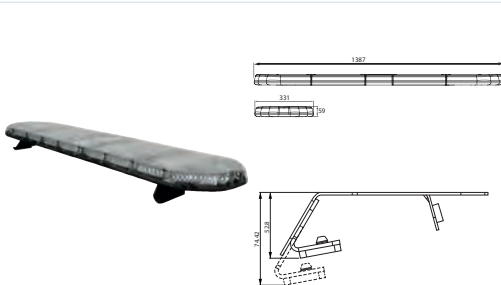

Voltage: 12
Amp: 17

Length: 1387 mm
Cable length: 5750 mm
Height: 59 mm
Width: 331 mm

Lens type: Polycarbonate
Colour: Orange
Material: Aluminium
Model: 140 cm/54"
Mount.: Plan
Base: Flexible
Flash patterns: 21
Hi impact: Yes
Waterproof: Yes
Tightness norm: IP 66
Approval: SAE/ECE-R65
E-approval: Yes
Alternativ no.: 172196

171853 LED Light bar Std pkg 1

Spare Parts: HC-CARGO 171857, 171859. Accessories: HC-CARGO 171865, 171762. Recommended fuse 15 A.

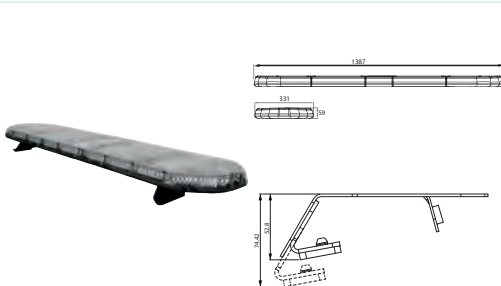

Voltage: 24
Amp: 17

Length: 1387 mm
Cable length: 5750 mm
Height: 59 mm
Width: 331 mm

Lens type: Polycarbonate
Colour: Orange
Material: Aluminium
Model: 140 cm/54"
Mount.: Plan
Base: Flexible
Flash patterns: 21
Hi impact: Yes
Waterproof: Yes
Tightness norm: IP 66
Approval: SAE/ECE-R65
E-approval: Yes
Alternativ no.: 172196

171854 LED Micro Light Bar Std pkg 1

Bracket for permanent mounting: HC-CARGO 171855. Change flash pattern on cigarplug. Can also be connected permanently.

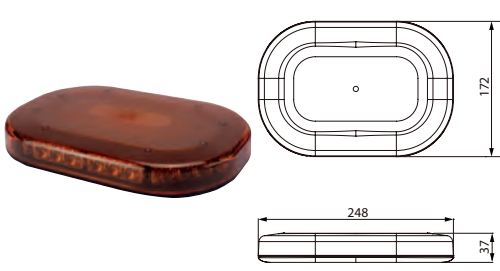

Voltage: 12/24
Amp: 4.2/1.05

OD: 172 mm
Length: 248 mm
Cable length: 3000 mm
Height: 37 mm

Bulb type: 30x1 W LED
Lens type: Polycarbonate
Colour: Orange
Mount.: Plan
Base: Magnetic
Flash patterns: 23
Hi impact: Yes
Waterproof: Yes
Tightness norm: IP 64K
Approval: SAE/ECE-R65
E-approval: Yes

171909 LED Light bar Std pkg 1

Spare Parts: HC-CARGO 171915, 171916. Accessories: HC-CARGO 171781, 171762. Recommended fuse 25 A.

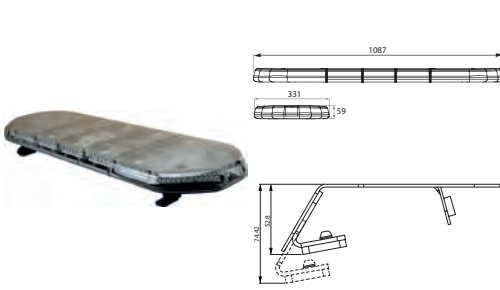

Voltage: 12
Amp: 16.4

Length: 1087 mm
Cable length: 5750 mm
Height: 59 mm
Width: 331 mm

Lens type: Polycarbonate
Colour: Blue
Material: Aluminium
Model: 110 cm/43"
Mount.: Plan
Base: Flexible
Flash patterns: 21
Hi impact: Yes
Waterproof: Yes
Tightness norm: IP 66
Approval: SAE/ECE-R65
E-approval: Yes

171910 LED Light bar Std pkg 1

Spare Parts: HC-CARGO 171856, 171858. Accessories: HC-CARGO 171781, 171762. Recommended fuse 20 A.

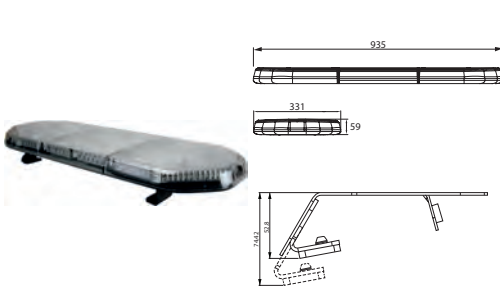

Voltage: 12
Amp: 8

Length: 935 mm
Cable length: 5750 mm
Height: 59 mm
Width: 331 mm

Lens type: Polycarbonate
Colour: Orange
Material: Aluminium
Model: 91.4 cm - 36"
Mount.: Plan
Base: Flexible
Flash patterns: 21
Hi impact: Yes
Waterproof: Yes
Tightness norm: IP 66
Approval: SAE/ECE-R65
E-approval: Yes
Alternativ no.: 172197

171912 LED Light bar Std pkg 1

Spare Parts: HC-CARGO 171856, 171858. Accessories: HC-CARGO 171781, 171762. Recommended fuse 25 A.

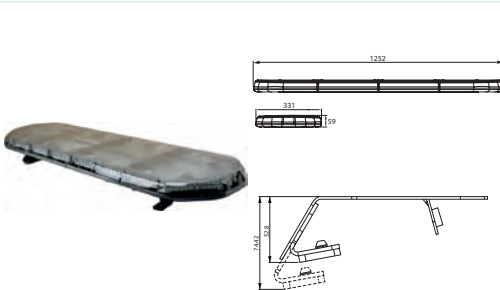

Voltage: 12
Amp: 16

Length: 1252 mm
Cable length: 5750 mm
Height: 59 mm
Width: 331 mm

Lens type: Polycarbonate
Colour: Orange
Material: Aluminium
Model: 124.5 cm/49"
Mount.: Plan
Base: Flexible
Flash patterns: 21
Hi impact: Yes
Waterproof: Yes
Tightness norm: IP 66
Approval: SAE/ECE-R65
E-approval: Yes
Alternativ no.: 172198

171913 LED Light bar Std pkg 1

Spare Parts: HC-CARGO 171857, 171859. Accessories: HC-CARGO 171865, 171762. Recommended fuse 15 A.



Voltage: 24
Amp: 16

Length: 1252 mm
Cable length: 5750 mm
Height: 59 mm
Width: 331 mm

Lens type: Polycarbonate
Colour: Orange
Material: Aluminium
Model: 124.5 cm/49"
Mount.: Plan
Base: Flexible
Flash patterns: 21
Hi impact: Yes
Waterproof: Yes
Tightness norm: IP 66
Approval: SAE/ECE-R65
E-approval: Yes
Alternativ no.: 172198

171914 LED Light bar Std pkg 1

Spare Parts: HC-CARGO 171857, 171859. Accessories: HC-CARGO 171865, 171762. Recommended fuse 20 A.

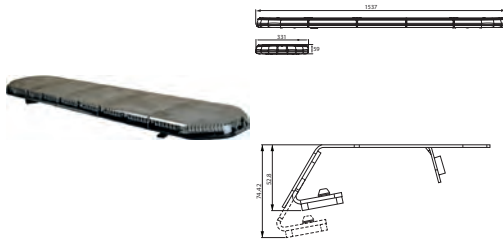

Voltage: 24
Amp: 18

Length: 1524 mm
Cable length: 5750 mm
Height: 59 mm
Width: 331 mm

Lens type: Polycarbonate
Colour: Orange
Material: Aluminium
Model: 152.4 cm/60"
Mount.: Plan
Base: Flexible
Flash patterns: 21
Hi impact: Yes
Waterproof: Yes
Tightness norm: IP 66
Approval: SAE/ECE-R66
E-approval: Yes
Alternativ no.: 172199

172094 LED Mini Light Bar Std pkg 1

Switch Panel: HC-CARGO 171762.

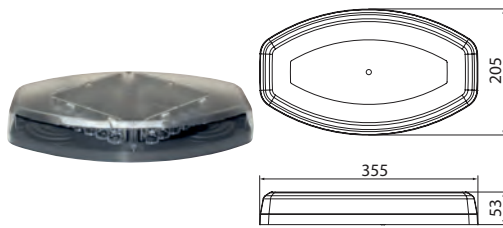

Voltage: 12/24
Amp: 2.88/1.44
Watt: 34.5

Length: 355 mm
Cable length: 3000 mm
Height: 53 mm
Dist. mount. holes: 204 mm
Width: 205 mm

Bulb type: 24 LED
Lens type: Polycarbonate
Colour: Orange
Material: Shockproof plastic
Mount.: Screw
Flash patterns: 23
Waterproof: Yes
Tightness norm: IP 64K
Approval: EMC-R10/ECE-R65
E-approval: Yes

172115 LED Mini Light Bar Std pkg 1

Switch Panel: HC-CARGO 171762.

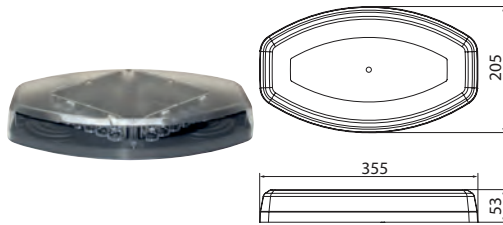

Voltage: 12/24
Amp: 2.88/1.44
Watt: 34.5

Length: 355 mm
Cable length: 3000 mm
Height: 53 mm
Dist. mount. holes: 204 mm
Width: 205 mm

Bulb type: 24 LED
Lens type: Polycarbonate
Colour: Blue
Material: Shockproof plastic
Mount.: Screw
Flash patterns: 23
Waterproof: Yes
Tightness norm: IP 64K
Approval: ECE-R10/ECE-R65
E-approval: Yes

172195 LED Light bar Std pkg 1

Switch Panel: HC-CARGO 172200. LED Flash: HC-CARGO 172207. LED Corner Flash: HC-CARGO 172208.

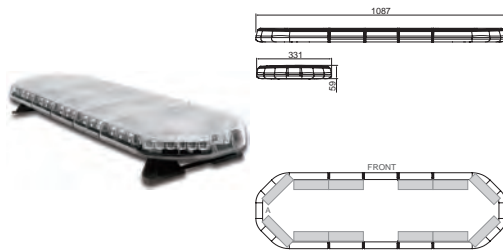

Voltage: 12/24
Amp: 10/7.5

Length: 1087 mm
Cable length: 5750 mm
Height: 59 mm
Width: 331 mm

Colour: Orange
Model: 110 43"
Mount.: Plan
Base: Flexible
Flash patterns: 7
Tightness norm: IP 66
Approval: SAE/ECE-R66
E-approval: Yes
Alternativ no.: 171850, 171851

172196 LED Light bar Std pkg 1



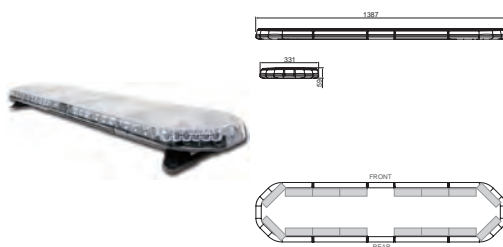





Switch Panel: HC-CARGO 172200. LED Flash: HC-CARGO 172207. LED Corner Flash: HC-CARGO 172208.

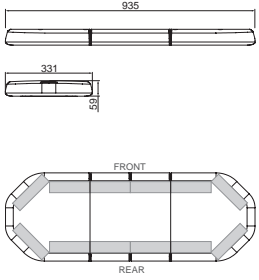
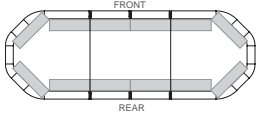

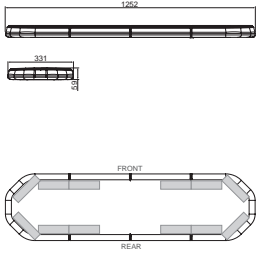
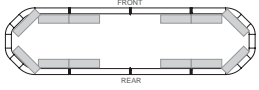
Voltage: 12/24
Amp: 15/7.5

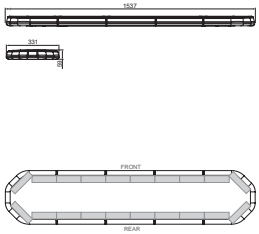
Length: 1387 mm
Cable length: 5750 mm
Height: 59 mm
Width: 331 mm

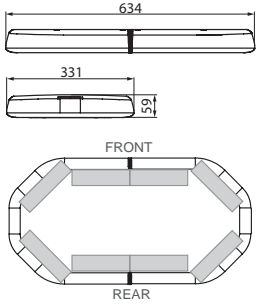
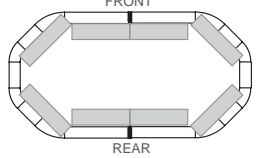
Colour: Orange
Model: 54"
Mount.: Plan
Base: Flexible
Flash patterns: 7
Tightness norm: IP 66
Approval: SAE/ECE-R66
E-approval: Yes
Alternativ no.: 171852, 171853

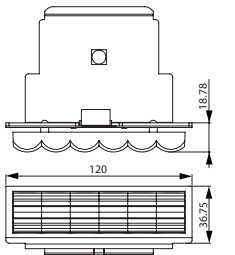
EL. SPECIFICATIONS		DIMENSIONS		ADDITIONAL SPECIFICATIONS	
172197 LED Light bar Std pkg 1 Switch Panel: HC-CARGO 172200. LED Flash: HC-CARGO 172207. LED Corner Flash: HC-CARGO 172208.					
		Voltage: 12/24 Amp: 10/5	Length: 935 mm Cable length: 5750 mm Height: 59 mm Width: 331 mm	Colour: Orange Model: 36" Mount.: Plan Base: Flexible Flash patterns: 7 Tightness norm: IP 66 Approval: SAE/ECE-R65 E-approval: Yes Alternativ no.: 171910	
					
172198 LED Light bar Std pkg 1 Switch Panel: HC-CARGO 172200. LED Flash: HC-CARGO 172207. LED Corner Flash: HC-CARGO 172208.					
		Voltage: 12/24 Amp: 15/7.5	Length: 1252 mm Cable length: 5750 mm Height: 59 mm Width: 331 mm	Colour: Orange Model: 49" Mount.: Plan Base: Flexible Flash patterns: 7 Tightness norm: IP 66 Approval: SAE/ECE-R65 E-approval: Yes Alternativ no.: 171912, 171913	
					
172199 LED Light bar Std pkg 1 Switch Panel: HC-CARGO 172200. LED Flash: HC-CARGO 172207. LED Corner Flash: HC-CARGO 172208.					
		Voltage: 12/24 Amp: 15/7.5	Length: 1537 mm Cable length: 5750 mm Height: 59 mm Width: 331 mm	Colour: Orange Model: 60" Mount.: Plan Base: Flexible Flash patterns: 7 Tightness norm: IP 66 Approval: SAE/ECE-R65 E-approval: Yes Alternativ no.: 171914	
					
172206 LED Light bar Std pkg 1 Switch Panel: HC-CARGO 172200. LED Flash: HC-CARGO 172207. LED Corner Flash: HC-CARGO 172208.					
		Voltage: 12/24 Amp: 7.5/5	Length: 634 mm Cable length: 5750 mm Height: 59 mm Width: 331 mm	Colour: Orange Model: 65 24" Mount.: Plan Base: Flexible Flash patterns: 7 Tightness norm: IP 66 Approval: SAE/ECE-R65 E-approval: Yes	
					
172207 LED Flash, amber Std pkg 1 Servicing: HC-CARGO 172195, 172196, 172197, 172198, 172199, 172206					
		Voltage: 12/24	Length: 120 mm Height: 36.75 mm Width: 18.78 mm	Bulb type: 3 LED Colour: Orange Approval: SAE/ECE-R65 E-approval: Yes	

ACCESSORIES
171682 Mounting Bracket for LED Mini Light Bar
Std pkg 1

Servicing: HC-CARGO 171680

 Thickness: 3 mm
Dist. mount. holes:
212 mm

171762 Switch Panel

Std pkg 1

Servicing: HC-CARGO 171760, 171761, 171849, 171850, 171851, 171852, 171853, 171909, 171910, 171911, 171912, 171913, 171914, 172094



Voltage: 12/24

 Mount. hole size:
4 mm

 Type/terminal: Flat
Colour: Black
Button colour: Black
Material: Metal
Switch combination: S1-S4 On/Off, S5 Shift

171777 LED Flash, amber

Std pkg 1

Servicing: HC-CARGO 171760, 171761

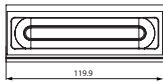

Voltage: 12

 Length: 119.9 mm
Height: 39.9 mm
Width: 18.8 mm

 Bulb type: 6 LED
Colour: Orange

171778 LED Corner Flash, orange

Std pkg 1

Servicing: HC-CARGO 171760, 171761

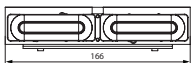

Voltage: 12

 Length: 166 mm
Height: 37 mm
Width: 18.8 mm

 Bulb type: 12 LED
Colour: Orange

171781 LED Alley light

Std pkg 1

Servicing: HC-CARGO 171760, 171761, 171849, 171850, 171852, 171909, 171910, 171912

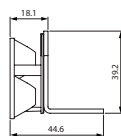
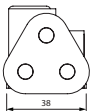

Voltage: 12

 Length: 38 mm
Height: 39.2 mm
Width: 18.1 mm

 Bulb type: 3 LED
Colour: Transparent
Approval: SAE/ECE-R65
E-approval: Yes

171855 Mounting Bracket for LED Micro Light Bar
Std pkg 1

Servicing: HC-CARGO 171854

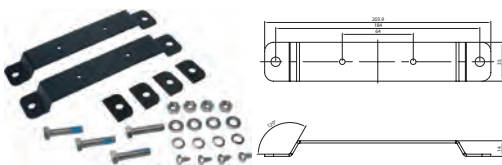
 Total length: 203.9 mm
Height: 14 mm
Dist. mount. holes:
64/184 mm
Width: 35 mm

171856 LED Flash, amber

Std pkg 1



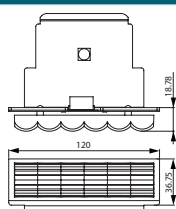







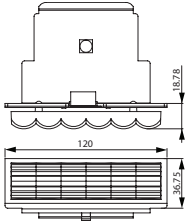

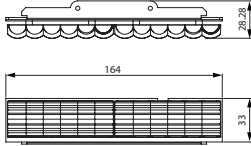
Servicing: HC-CARGO 171849, 171850, 171852, 171910, 171912

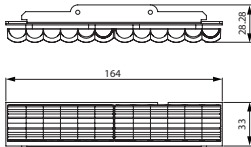

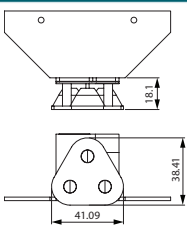
Voltage: 12

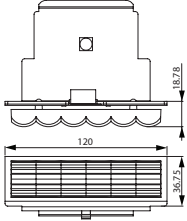
 Length: 120 mm
Height: 36.75 mm
Width: 18.78 mm

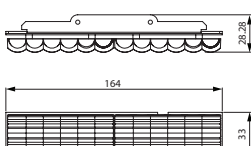
 Bulb type: 6 LED
Colour: Orange
Approval: SAE/ECE-R65
E-approval: Yes

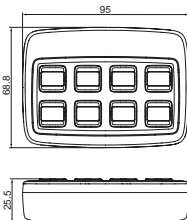
		EL. SPECIFICATIONS	DIMENSIONS	ADDITIONAL SPECIFICATIONS
171857	LED Flash, amber	Std pkg 1	Servicing: HC-CARGO 171851, 171853, 171911, 171913, 171914	
		Voltage: 24	Length: 120 mm Height: 36.75 mm Width: 18.78 mm	Bulb type: 6 LED Colour: Orange Approval: SAE/ECE-R65 E-approval: Yes
171858	LED Corner Flash, orange	Std pkg 1	Servicing: HC-CARGO 171849, 171850, 171852, 171910, 171912	
		Voltage: 12	Length: 164 mm Height: 33 mm Width: 28.28 mm	Bulb type: 12 LED Colour: Orange Approval: SAE/ECE-R65 E-approval: Yes
171859	LED Corner Flash, orange	Std pkg 1	Servicing: HC-CARGO 171851, 171853, 171911, 171913, 171914	
		Voltage: 24	Length: 164 mm Height: 33 mm Width: 28.28 mm	Bulb type: 12 LED Colour: Orange Approval: SAE/ECE-R65 E-approval: Yes
171865	LED Alley light	Std pkg 1	Servicing: HC-CARGO 171851, 171853, 171911, 171913, 171914	
		Voltage: 24	Height: 38.41 mm	Bulb type: 3 LED Approval: SAE/ECE-R65 E-approval: Yes
171915	LED Flash, blue	Std pkg 1	Servicing: HC-CARGO 171909	
		Voltage: 12	Length: 120 mm Height: 36.75 mm Width: 18.78 mm	Bulb type: 6 LED Colour: Blue Approval: SAE/ECE-R65 E-approval: Yes
171916	LED Corner Flash	Std pkg 1	Servicing: HC-CARGO 171909	
		Voltage: 12	Length: 164 mm Height: 33 mm Width: 28.28 mm	Bulb type: 12 LED Colour: Blue Approval: SAE/ECE-R65 E-approval: Yes
172200	Switch Panel w/ suction cup holder.	Std pkg 1	Servicing: HC-CARGO 171849, 171850, 171851, 171852, 171853, 171909, 171910, 171912, 171913, 171914, 172195, 172196, 172197, 172198	
		Voltage: 10-24 Amp: 1.2		Colour: Black Button colour: Grey Switch combination: On/Off Approval: ECE R10

172208 LED Corner Flash, orange Std pkg 1 Servicing: HC-CARGO 172195, 172196, 172197, 172198, 172199, 172206

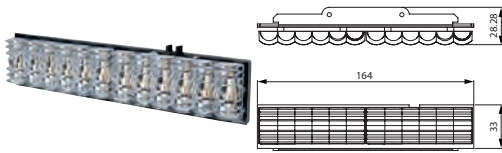

Voltage: 12/24

Length: 164 mm
Height: 33 mm
Width: 28.28 mm

Bulb type: 6 LED
Colour: Orange
Approval: SAE/ECE-R65
E-approval: Yes

172229 Switch Panel Std pkg 1 Servicing: HC-CARGO 171849, 171850, 171851, 171852, 171853, 171909, 171910, 171912, 171913, 171914, 172195, 172196, 172197, 172198
w/ suction cup holder.



Voltage: 10-24
Amp: 32

Colour: Black
Button colour: Grey
Switch combination: On/Off
Approval: ECE R10

SPOT LIGHTS

LED

172228 LED Blue Light Std pkg 1



Voltage: 10-80
Watt: 8

Type: 2 LED
Colour: Blue
Material/ bracket: Stainless steel
Material/dome: Polycarbonate
Material/house: Cast aluminum
Shape: Oval
Mount. bracket: U-bracket w/ 1 bolt
2 poles: w/
Tightness norm: IP 67
E-approval: Yes

BEACON SOCKETS

170292 Beacon Socket Std pkg 1

Rubber Body: HC-CARGO 171513. Coiled Cable: HC-CARGO 171518. Socket: HC-CARGO 180376.



Length: 100 mm

Material: Steel
Mount.: Weld
Bracket: Straight
Socket: DIN 72591 1 terminal

170387 Beacon Socket Std pkg 1

Rubber Body: HC-CARGO 171513. Coiled Cable: HC-CARGO 171518. Socket: HC-CARGO 180376.



Material: Electro galvanized
Mount.: w/ nuts
Bracket: Straight
Socket: DIN 72591 1 terminal

170405 Beacon Socket Std pkg 1

Rubber Body: HC-CARGO 171513. Coiled Cable: HC-CARGO 171518. Socket: HC-CARGO 180377.



Length: 108 mm
Mount. hole size:
10 mm

Material: Galvanized steel
Mount.: Flat
Bracket: Angled 90°
Socket: DIN 72591 2 terminal

EL. SPECIFICATIONS		DIMENSIONS	ADDITIONAL SPECIFICATIONS
170406 Beacon Socket Std pkg 1 <i>Rubber Body: HC-CARGO 171513. Coiled Cable: HC-CARGO 171518. Socket: HC-CARGO 180377.</i>			
		Length: 100 mm	Material: Galvanized steel Mount.: 2 screws Bracket: Adjustable Socket: DIN 72591 2 terminal
170419 Beacon Socket Std pkg 1 <i>Rubber Body: HC-CARGO 171513. Coiled Cable: HC-CARGO 171518. Socket: HC-CARGO 180377.</i>			
		Length: 170 mm	Material: Galvanized steel Mount.: Vertical Bracket: Angled 90° Socket: DIN 72591 2 terminal
170460 Beacon Socket Std pkg 1 Servicing: John Deere tractor etc - Visit our web catalogue for further information <i>Rubber Body: HC-CARGO 171513. Coiled Cable: HC-CARGO 171518. Socket: HC-CARGO 180377.</i>			
		Length: 100 mm	Material: Galvanized steel Mount.: 1 bolt Bracket: Angled Socket: DIN 72591 2 terminal
170531 Extension Std pkg 1 Servicing: Mercedes-Benz - Visit our web catalogue for further information <i>Rubber Body: HC-CARGO 171513. Coiled Cable: HC-CARGO 171518. Socket: HC-CARGO 180377.</i>			
		Length: 500 mm Mount. hole size: 24 mm	Material: Galvanized steel Bracket: Straight Socket: DIN 72591 2 terminal
170537 Beacon Socket Std pkg 1 <i>Rubber Body: HC-CARGO 171513. Coiled Cable: HC-CARGO 171518. Socket: HC-CARGO 180377.</i>			
		Length: 100 mm	Material: Electro galvanized Mount.: Vertical Bracket: Straight Socket: DIN 72591 2 terminal
170562 Beacon Socket Std pkg 1 <i>Rubber Body: HC-CARGO 171513. Coiled Cable: HC-CARGO 171518. Socket: HC-CARGO 180376, 180377.</i>			
		Length: 100 mm	Material: Galvanized steel Mount.: 2 screws Bracket: Angled 90° Socket: DIN 72591 2 terminal
170788 Beacon Socket Std pkg 1 <i>Rubber Body: HC-CARGO 171513. Coiled Cable: HC-CARGO 171518. Socket: HC-CARGO 180376.</i>			
		Length: 102 mm Mount. hole size: 10 mm	Material: Electro galvanized Mount.: Flat Bracket: Angled Socket: DIN 72591 1 terminal

170789 Beacon Socket Std pkg 1

Rubber Body: HC-CARGO 171513. Coiled Cable: HC-CARGO 171518. Socket: HC-CARGO 180376.



Length: 136 mm

Material: Electro galvanized
Bracket: Adjustable
Socket: DIN 72591 1 terminal

171576 Beacon Socket Std pkg 1 Servicing: IH/CASE - Visit our web catalogue for further information

Rubber Body: HC-CARGO 171513. Coiled Cable: HC-CARGO 171518. Socket: HC-CARGO 180377.



Length: 190 mm

Material: Steel
Mount.: Vertical
Bracket: Straight
Socket: DIN 72591 2 terminal

SPARE PARTS

171513 Rubber Body for Beacon Socket Std pkg 10 Servicing: HC-CARGO 170292, 170387, 170405, 170788, 170406, 170562, 170789, 170537, 171576, 170419, 170460



Material: Rubber

171518 Coiled Cable Std pkg 1 Servicing: HC-CARGO 170292, 170387, 170405, 170788, 170406, 170562, 170789, 170537, 171576, 170419, 170460



Working length: 2 m

Plug type: Cigar plug
Plug 1: 2
ISO norm: 4165

171562 Coiled Cable Std pkg 1 Servicing: HC-CARGO 171494, 171495



Working length: 3 m

Plug type: Cigar plug

180376 DIN Socket Std pkg 5 Servicing: HC-CARGO 170292, 170387, 170788, 170789

Also used in sockets for beacons.



ID/mount. hole:
18.5 mm

Material: Brass
No./poles: 1
Male/female: Female
DIN norm: 72591

180377 DIN Socket Std pkg 5 Servicing: HC-CARGO 170405, 170406, 170419, 170460, 170531, 170537, 170562, 171576

Also used in sockets for beacons.



ID/mount. hole:
18.5 mm

Material: Brass
No./poles: 2
Male/female: Female
DIN norm: 72591

WORK LAMPS CONVENTIONAL

170093 Work Lamp

Std pkg 1

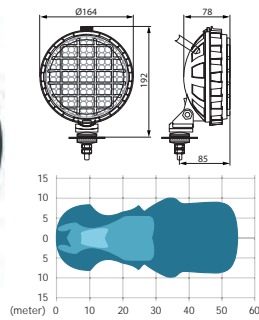

Bulb incl.: No

 Dim.: 164x192x85 mm
 Light aperture:
 136 mm

 Type: H3
 Socket type: PK22s
 Colour: Black
 Material/dome: Glass
 Material/house: Plastic
Reflector system: Single
 Shape: Round
 Switch: w/
 Mount. bracket: Single bolt fixing
 Grill: w/
 Handle: w/

170237 Work Lamp

Std pkg 1

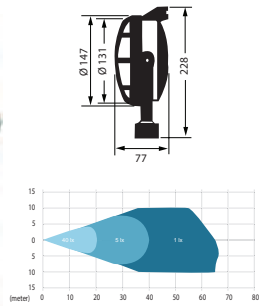

Bulb incl.: No

 Dim.: 228x77 mm
 Light aperture:
 131 mm

 Type: H3
 Socket type: PK22s
 Colour: Black
 Material/dome: Glass
 Material/house: Shockproof plastic
Reflector system: Single
 Shape: Round
 Switch: w/
 Mount. bracket: U-bracket w/ 2 holes
 Grill: w/
 Handle: w/

170313 Work Lamp

Std pkg 1

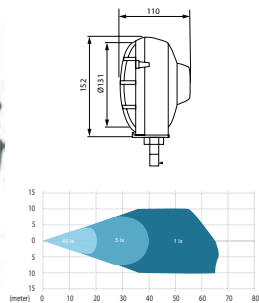

Bulb incl.: No

 Dim.: 152x110 mm
 Light aperture:
 131 mm

 Type: H3
 Socket type: PK22s
 Colour: Black
 Material/dome: Glass
 Material/house: Shockproof plastic
Reflector system: Single
 Shape: Round
 Switch: w/o
 Mount. bracket: Single bolt fixing
 Grill: w/
 Handle: w/o

170488 Work Lamp

Std pkg 1

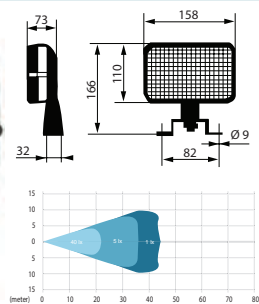

Bulb incl.: No

 Dim.: 166x158x73 mm
 Light aperture:
 155x104 mm

 Type: H3
 Socket type: PK22s
 Colour: Black
 Material/dome: Glass
 Material/house: Shockproof plastic
Reflector system: Single
 Shape: Rectangular
 Switch: w/o
 Mount. bracket: U-bracket w/ 4 holes
 Grill: w/
 Handle: w/o

170489 Work Lamp

Std pkg 1

w/o U-bracket.

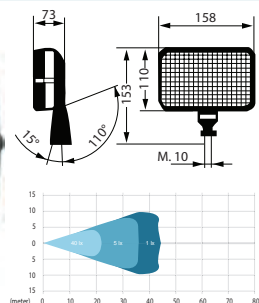

Bulb incl.: No

 Dim.: 158x153x73 mm
 Light aperture:
 155x104 mm

 Type: H3
 Socket type: PK22s
 Colour: Black
 Material/dome: Glass
 Material/house: Shockproof plastic
Reflector system: Single
 Shape: Rectangular
 Switch: w/o
 Mount. bracket: Single bolt fixing
 Grill: w/
 Handle: w/o

170534 Work Lamp Std pkg 1

Bracket: HC-CARGO 171936.

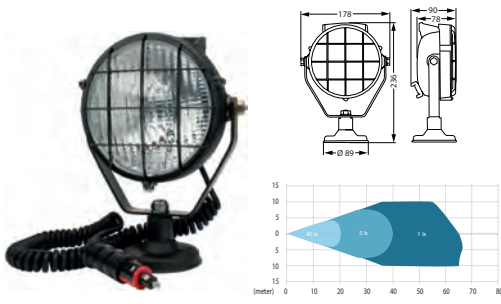

Bulb incl.: No

Dim.: 178x236x90 mm
Coiled cable: 2000 mm
Light aperture:
130 mm

Type: H3
Socket type: PK22s
Colour: Black
Material/dome: Glass
Material/house: Polyamid
Shape: Round
Switch: w/
Grill: w/
Magnet base: w/
Lighter plug incl.: Yes
Handle: w/
Coiled cable incl.: Yes

170857 Work Lamp Std pkg 1

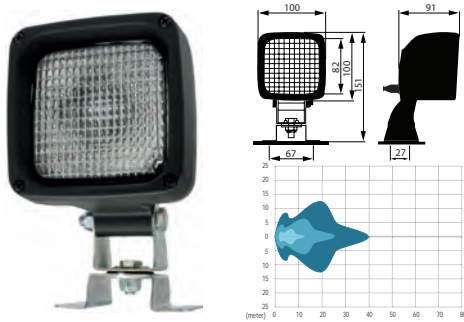

Bulb incl.: No

Dim.: 100x151x91 mm
Light aperture:
73x73 mm

Type: H3
Socket type: PK22s
Colour: Black
Material/dome: Glass
Material/house: Shockproof plastic
Reflector system: Free form
Shape: Square
Mount.: Upright/pendant
Switch: w/o
Mount. bracket: U-bracket w/ 4 holes
Grill: w/o
Handle: w/o
2 poles: w/
Tightness norm: IP 66
Alternativ no.: 170982

170859 Work Lamp Std pkg 1

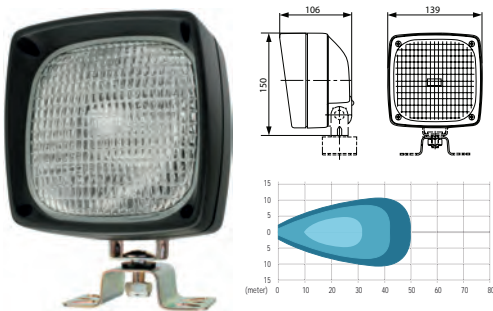

Bulb incl.: No

Dim.: 139x150x106 mm
Light aperture:
123x123 mm

Type: H3
Socket type: PK22s
Colour: Black
Material/dome: Glass
Material/house: Shockproof plastic
Reflector system: Free form
Shape: Square
Switch: w/o
Mount. bracket: U-bracket w/ 6 holes
Handle: w/o

170970 Work Lamp Std pkg 1

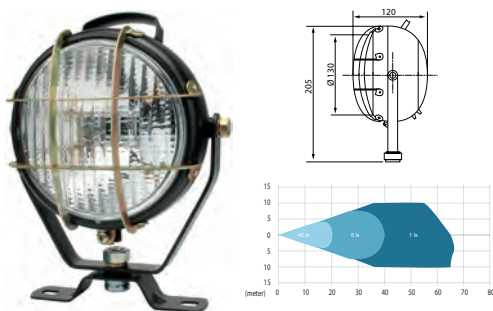

Bulb incl.: No

Dim.: 205x120 mm
Light aperture:
130 mm

Type: H3
Socket type: PK22s
Colour: Black
Material/dome: Glass
Material/house: Metal
Shape: Round
Switch: w/
Mount. bracket: U-bracket w/ 2 holes
Grill: w/
Handle: w/

170979 Work Lamp Std pkg 1

External plug for flat plug connection.



Bulb incl.: No

Dim.: 160x145x50 mm
Light aperture:
123x72 mm

Type: H3
Socket type: PK22s
Colour: Black
Material/dome: Glass
Material/house: Shockproof plastic
Shape: Rectangular
Mount.: Flat
Switch: w/o
Mount. bracket: U-bracket w/ 4 holes
Grill: w/o
Handle: w/o

170980 Work Lamp

Std pkg 1

Servicing: Universal - Visit our web catalogue for further information

External plug for flat plug connection.

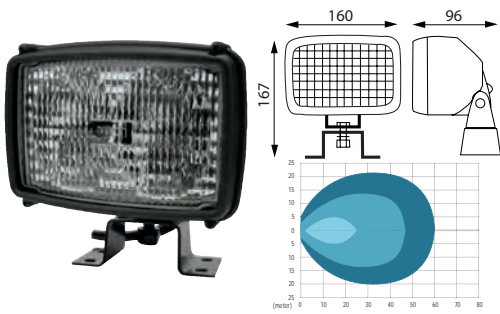

Bulb incl.: No

Dim.: 160x167x96 mm
Light aperture:
123x78 mm

Type: H3
Socket type: PK22s
Colour: Black
Material/dome: Glass
Material/house: Shockproof plastic
Reflector system: Dual
Shape: Rectangular
Mount.: Flat
Switch: w/o
Mount. bracket: U-bracket w/ 4 holes
Grill: w/o
Handle: w/o
2 poles: w/o
Tightness norm: IP 65
Alternativ no.: 170851

170981 Work Lamp

Std pkg 1

External plug for flat plug connection.

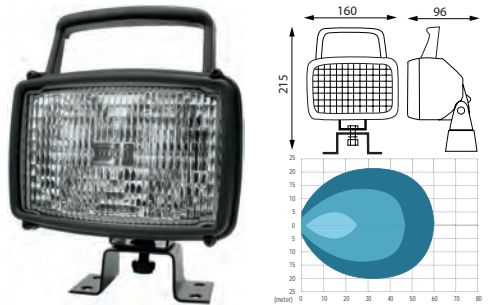

Bulb incl.: No

Dim.: 160x215x96 mm
Light aperture:
123x78 mm

Type: H3
Socket type: PK22s
Colour: Black
Material/dome: Glass
Material/house: Shockproof plastic
Reflector system: Dual
Shape: Rectangular
Mount.: Flat
Switch: w/
Mount. bracket: U-bracket w/ 4 holes
Handle: w/
2 poles: w/o
Tightness norm: IP 65

170982 Work Lamp

Std pkg 1

External plug for 6.3 mm flat plug connection.

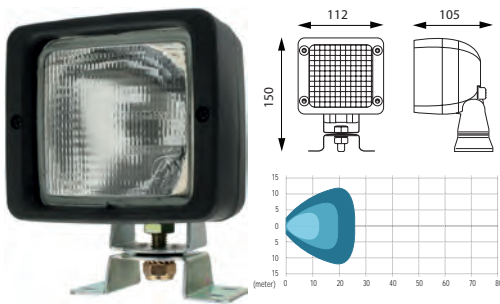

Bulb incl.: No

Dim.: 112x150x105 mm
Light aperture:
73x73 mm

Type: H3
Socket type: PK22s
Colour: Black
Material/dome: Glass
Material/house: Shockproof plastic
Reflector system: Single
Shape: Square
Mount.: Flat
Switch: w/o
Mount. bracket: U-bracket w/ 4 holes
Grill: w/o
Handle: w/o
Tightness norm: IP 67
Alternativ no.: 170857

170983 Work Lamp

Std pkg 1

External plug for 6.3 mm flat plug connection.



Bulb incl.: No

Dim.: 112x200x105 mm
Light aperture:
73x73 mm

Type: H3
Socket type: PK22s
Colour: Black
Material/dome: Glass
Material/house: Shockproof plastic
Reflector system: Single
Shape: Square
Mount.: Flat
Switch: w/
Mount. bracket: U-bracket w/ 4 holes
Handle: w/
Tightness norm: IP 65

170984 Work Lamp

Std pkg 1

External plug for 6.3 mm flat plug connection.

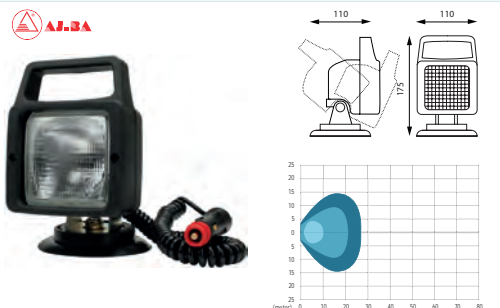

Bulb incl.: No

Dim.: 110x175x110 mm
Coiled cable: 2000 mm
Light aperture:
73x73 mm

Type: H3
Socket type: PK22s
Colour: Black
Material/dome: Glass
Material/house: Shockproof plastic
Reflector system: Single
Shape: Square
Switch: w/
Magnet base: w/
Lighter plug incl.: Yes
Handle: w/
2 poles: w/
Coiled cable incl.: Yes

171347 Work Lamp

Std pkg 1

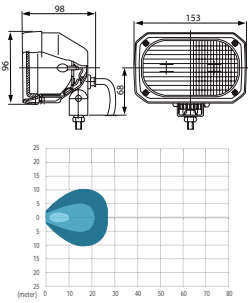

Bulb incl.: No

Dim.: 153x96x98 mm
Light aperture:
124x72 mm

Type: H3
Socket type: PK22s
Colour: Black
Material/dome: Glass
Material/house: Shockproof plastic
Reflector system: Single
Shape: Rectangular
Mount.: Upright/pendant
Switch: w/o
Mount. bracket: Single bolt fixing
Grill: w/o
Handle: w/o

171449 Work Lamp

Std pkg 1

External plug for multiplug connection.

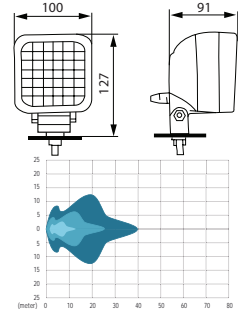

Bulb incl.: No
Watt: 55

Dim.: 100x127x91 mm
Light aperture:
73x73 mm

Type: H3
Socket type: PK22s
Colour: Black
Material/dome: Shockproof plastic
Material/house: Glass
Reflector system: Single
Shape: Square
Mount.: Upright/pendant
Switch: w/o
Mount. bracket: Single bolt fixing
Grill: w/o
Handle: w/o
2 poles: w/
Tightness norm: IP 66

171564 Work Lamp

Std pkg 1

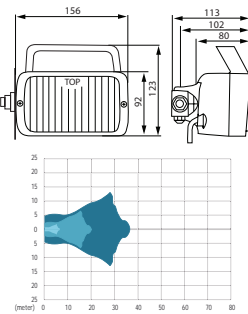

Bulb incl.: No

Dim.: 156x117x85 mm
Light aperture:
120x68 mm

Type: H3
Socket type: PK22s
Material/dome: Shockproof plastic
Material/house: Glass
Shape: Rectangular
Switch: w/
Grill: w/o
Handle: w/
Tightness norm: IP 55

171566 Work Lamp

Std pkg 1

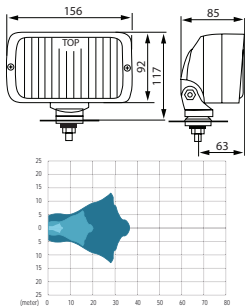

Bulb incl.: No

Dim.: 156x123x113 mm
Light aperture:
123x70 mm

Type: H3
Socket type: PK22s
Inclination/downwards: 180°
Inclination/upwards: 180°
Inclination/sideways: 105°
Colour: Black
Material/dome: Glass
Material/house: Shockproof plastic
Shape: Rectangular
Mount.: Sidemounted
Switch: w/o
Grill: w/o
Handle: w/o
Tightness norm: IP 55

171619 Work Lamp



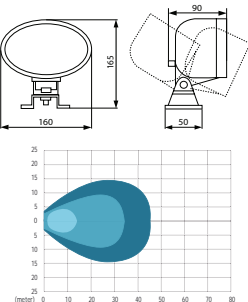





Std pkg 1

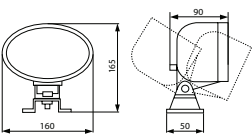

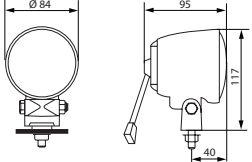
Bulb incl.: No
Watt: 70

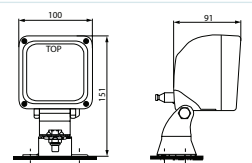
Dim.: 160x165x90 mm
Light aperture:
77x130 mm

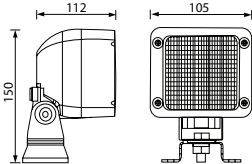
Type: H3
Socket type: PK22s
Colour: Black
Material/dome: Glass
Material/house: Shockproof plastic
Reflector system: Single
Model: Compact 5000
Shape: Oval
Switch: w/o
Mount. bracket: 4 holes
2 poles: w/

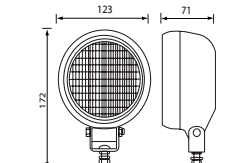
171620 Work Lamp		Std pkg 1			
		<p>Bulb incl.: No</p>	<p>Dim.: 160x165x90 mm Light aperture: 77x130 mm</p>	<p>Type: H3 Socket type: PK22s Colour: Black Material/dome: Shockproof plastic Reflector system: Dual Model: Twin beam 5000 Shape: Oval Switch: w/o Mount. bracket: 4 holes 2 poles: w/</p>	
171745 Work Lamp		Std pkg 1			
		<p>Bulb incl.: No</p>	<p>Dim.: 117x84x95 mm Light aperture: 69 mm</p>	<p>Type: H3 Socket type: PK22s Colour: Black Material/dome: Glass Material/house: ABS plastic Reflector system: Single Shape: Round Switch: w/o Mount. bracket: U-bracket w/ 1 bolt Handle: w/o 2 poles: w/ Tightness norm: IP 66</p>	
171782 Work Lamp		Std pkg 1			
w/ Deutsch multiconnection.					
		<p>Bulb incl.: No</p>	<p>Dim.: 100x151x91 mm Light aperture: 73x73 mm</p>	<p>Type: H3 Socket type: PK22s Colour: Black Material/dome: Glass Material/house: Shockproof plastic Reflector system: Single Shape: Square Mount.: Upright/pendant Switch: w/ Mount. bracket: Single bolt fixing Handle: w/o 2 poles: w/ Tightness norm: IP 66</p>	
171845 Work Lamp		Std pkg 1		Servicing: Marine - Visit our web catalogue for further information	
		<p>Bulb incl.: No Voltage: 12 Watt: 55</p>	<p>Dim.: 105x150x112 mm</p>	<p>Type: H3 Socket type: PK22s Colour: White Material/dome: Glass Shape: Square Mount.: Single bolt fixing Switch: w/o Mount. bracket: Mounting bracket Tightness norm: IP 65</p>	
171848 Work Lamp		Std pkg 1			
		<p>Bulb incl.: No</p>	<p>Dim.: 123x172x71 mm</p>	<p>Type: H3 Socket type: PK22s Colour: Black Material/dome: Glass Material/house: PVC Shape: Round Switch: w/o Mount. bracket: Single bolt fixing</p>	

ACCESSORIES

171936 Magnetic base for Lamps Std pkg 1 Servicing: HC-CARGO 170534



Coiled cable: 2000 mm

Colour: Black
Mount.: Magnetic
Mount. bracket: U-bracket w/ 2 holes
Magnet base: w/
Lighter plug incl.: Yes
Coiled cable incl.: Yes

WORK LAMPS LED

171671 LED Work Lamp Std pkg 1

4 diodes. Black cable negative.

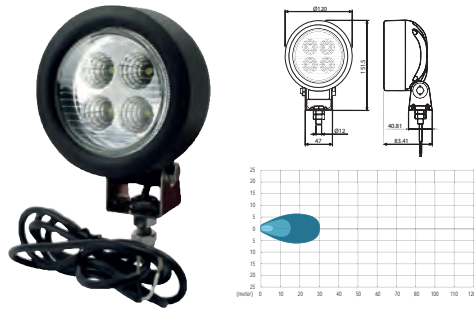

Voltage: 10-64
Watt: 8.5
Candela: 800
Kelvin: 5000-6500
Lumen: 450

Dim.:
151.5x120x83.41 mm
Cable length: 2000 mm
Light aperture:
100 mm

Type: 4 LED
Colour: Black
Material/dome: Shockproof plastic
Material/house: Shock thermo plastic
Reflector system: Spot
Shape: Round
Switch: w/o
Mount. bracket: 1 nut
Magnet base: w/o
Handle: w/o
Tightness norm: IP 66
Approval: CE

171672 LED Work Lamp Std pkg 1

4 diodes.

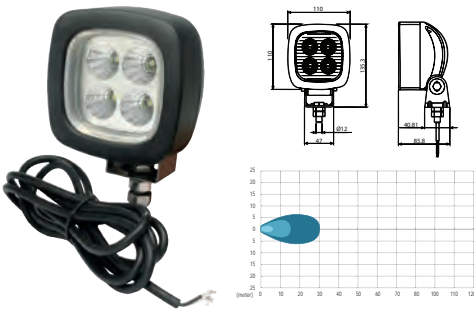

Voltage: 10-64
Watt: 8.5
Candela: 800
Kelvin: 5000-6500
Lumen: 450

Dim.:
135.5x110x85.8 mm
Cable length: 2000 mm
Light aperture:
100 mm

Type: 4 LED
Colour: Black
Material/dome: Shockproof plastic
Material/house: Shockproof plastic
Reflector system: Spot
Shape: Square
Switch: w/o
Mount. bracket: 1 nut
Tightness norm: IP 66
Approval: CE

171727 LED Work Lamp Std pkg 1

Grey lead +, white lead -.

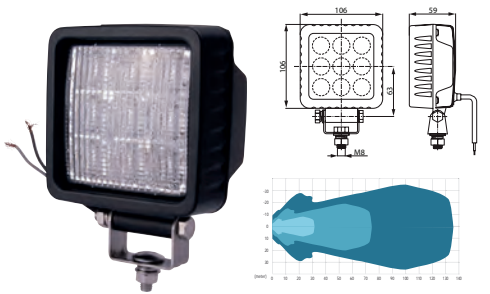

Voltage: 9-33
Watt: 9
Kelvin: 5000-5500
Lumen: 900

Dim.: 106x106x59 mm
Cable length: 450 mm
Light aperture:
85x85 mm

Type: 9 LED
Colour: Black
Material/dome: Shockproof plastic
Material/house: Cast aluminum
Reflector system: Flood
Shape: Square
Switch: w/o
Mount. bracket: U-bracket w/ 1 bolt
Handle: w/o
Tightness norm: IP 67
Approval: CE/EMC

171751 LED Work Lamp Std pkg 1

White cable to ground. Black cable to +12/36 V.

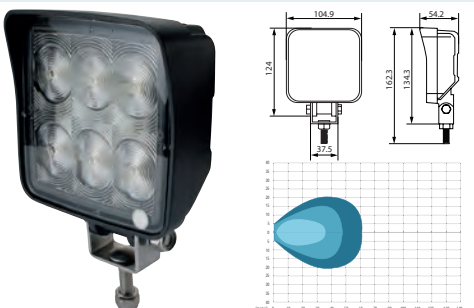

Voltage: 9-36
Watt: 19
Candela: 2210
Lumen: 1200

Dim.:
104.9x162.3x54.2 mm
Cable length: 280 mm
Light aperture:
100x100 mm

Type: 6 LED
Colour: Black
Material/dome: Polycarbonate
Material/house: Cast aluminum
Reflector system: Flood
Shape: Square
Switch: w/o
Mount. bracket: U-bracket w/ 1 bolt
Handle: w/o
Tightness norm: IP 69K
Approval: CE/EMC
Alternativ no.: 172126

171752 LED Work Lamp		Std pkg 1	
<i>White cable to ground. Black cable to +12/36 V.</i>			
	<p> Voltage: 12-36 Watt: 20 Candela: 3600 Lumen: 1800 </p>	<p> Dim.: 125x176x60.1 mm Cable length: 280 mm Light aperture: 93x83 mm </p>	<p> Type: 9 LED Colour: Black Material/ bracket: Stainless steel Material/dome: Polycarbonate Material/house: Aluminium Reflector system: Flood Shape: Square Switch: w/o Mount. bracket: U-bracket w/ 1 bolt Tightness norm: IP 69K Approval: CE/EMC Alternativ no.: 172129 </p>
171753 LED Work Lamp		Std pkg 1	
	<p> Voltage: 11-70 Watt: 22 Lumen: 1000 </p>	<p> Dim.: 110.4x184x67 mm Cable length: 1200 mm Light aperture: 88x88 mm </p>	<p> Type: 6 LED Colour: Black Material/house: Cast aluminum Reflector system: Flood Shape: Square Switch: w/o Mount. bracket: Single bolt fixing Tightness norm: IP 67 Approval: EMC </p>
171755 LED Work Lamp		Std pkg 1	
	<p> Voltage: 11-70 Watt: 27 Lumen: 1900 </p>	<p> Dim.: 110.4x184x67 mm Cable length: 1200 mm Light aperture: 88x88 mm </p>	<p> Type: 6 LED Colour: Black Material/house: Cast aluminum Reflector system: Flood Shape: Square Switch: w/o Mount. bracket: Single bolt fixing Tightness norm: IP 67 Approval: EMC E-approval: No </p>
171811 LED Work Lamp		Std pkg 1	
	<p> Voltage: 10-80 Watt: 5 Candela: 2000 Kelvin: 5000-6500 Lumen: 600 </p>	<p> Dim.: 72.3x52x51.87 mm Cable length: 300 mm Light aperture: 35 mm </p>	<p> Type: 1 LED Inclination/downwards: Yes Inclination/upwards: Yes Colour: Black Material/dome: Plastic Material/house: Aluminium Reflector system: Spot Shape: Round Switch: w/o Mount. bracket: U-bracket w/ 1 bolt Tightness norm: IP 66 Approval: CE </p>
171838 LED Work Lamp		Std pkg 1	
	<p> Voltage: 9-36 Amp: 1.2/2.5 Watt: 28-30 Lumen: 3000 </p>	<p> Dim.: 132x108x76 mm Cable length: 150 mm </p>	<p> Type: 20 LED Colour: Black Material/dome: Polycarbonate Material/house: Aluminium Reflector system: Flood Shape: Square Switch: w/o Mount. bracket: Single bolt fixing 2 poles: w/ Tightness norm: IP 67 Approval: CE </p>

171846 LED Work Lamp Std pkg 1

2 pin AMP connector.



Voltage: 9-36
Amp: 6/3
Watt: 67.5
Lumen: 5400

Dim.: 170x206x87 mm
Cable length: 450 mm

Type: 30 LED
Inclination/downwards: 45°
Inclination/upwards: 45°
Colour: Black
Material/dome: Polycarbonate
Material/house: Aluminium
Reflector system: Spot
Shape: Round
Switch: w/o
Mount. bracket: U-bracket w/ 1 bolt
2 poles: w/
Tightness norm: IP 67
Approval: CE

171847 LED Work Lamp Std pkg 1

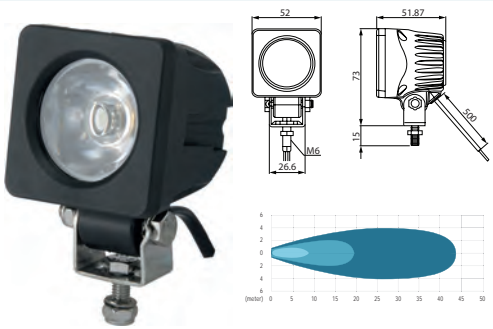

Voltage: 10-80
Amp: 0.3
Watt: 5
Candela: 2000
Kelvin: 5000-6500
Lumen: 600

Dim.: 52x51.9x72.3 mm
Cable length: 500 mm

Type: 1 LED
Inclination/downwards: Yes
Inclination/upwards: Yes
Colour: Black
Reflector system: Spot
Shape: Square
Switch: w/o
Tightness norm: IP 67
Approval: CE

171938 LED Work Lamp Std pkg 1

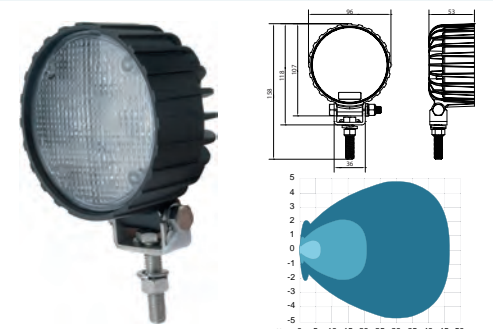

Voltage: 9-50
Amp: <0.55
Watt: 10.8
Lumen: 900

Dim.: 96x118x53 mm
Cable length: 380 mm
Light aperture: 90 mm

Type: 4 LED
Colour: Black
Material/dome: Polycarbonate
Material/house: Aluminium
Reflector system: Flood
Shape: Round
Switch: w/o
Mount. bracket: 1 bolt
Tightness norm: IP 68
Approval: CE/EMC

171939 LED Work Lamp Std pkg 1

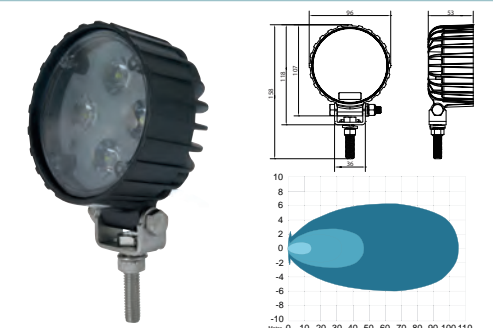

Voltage: 9-50
Amp: <0.65
Watt: 11
Lumen: 900

Dim.: 96x118 mm
Cable length: 380 mm
Light aperture: 90 mm

Type: 4 LED
Colour: Black
Material/dome: Polycarbonate
Material/house: Aluminium
Reflector system: Spot
Shape: Round
Switch: w/o
Mount. bracket: 1 bolt
Tightness norm: IP 68
Approval: CE/EMC



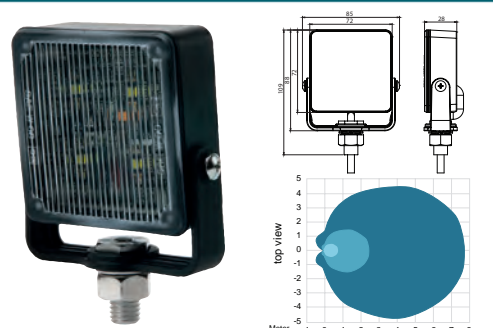





171940 LED Work Lamp Std pkg 1

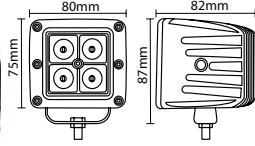
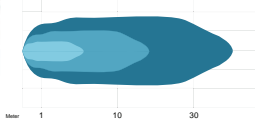

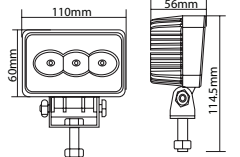
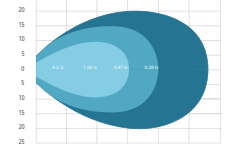
Voltage: 12-24
Amp: 0.37
Watt: 7.5
Lumen: 300

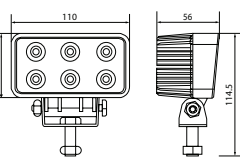
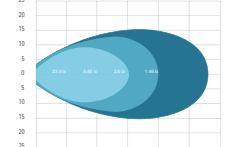
Dim.: 88x85 mm
Cable length: 380 mm
Light aperture: 72 mm

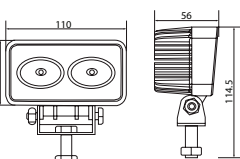
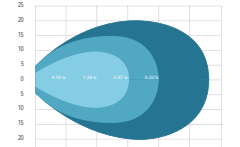
Type: 4 LED
Material/dome: Polycarbonate
Material/house: Aluminium
Reflector system: Flood
Shape: Square
Switch: w/o
Mount. bracket: U-bracket w/ 1 bolt
Tightness norm: IP 67
Approval: CE

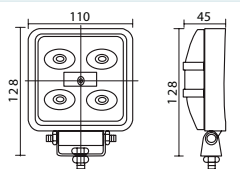
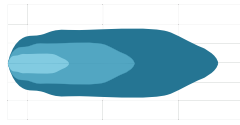
		EL. SPECIFICATIONS	DIMENSIONS	ADDITIONAL SPECIFICATIONS
171944 LED Work Lamp		Std pkg 1		
  	<p>Voltage: 10-30 Watt: 16 Kelvin: 6000 Lumen: 800</p>	<p>Dim.: 87x80x75 mm Cable length: 400 mm</p>	<p>Type: 4 LED Colour: Black Material/ bracket: Stainless steel Material/dome: Polycarbonate Material/house: Cast aluminum Reflector system: Flood Shape: Square Mount.: Cable Switch: w/o Tightness norm: IP 67 Approval: CE/EMC</p>	
171945 LED Work Lamp		Std pkg 1		
  	<p>Voltage: 10-30 Watt: 9 Kelvin: 6000 Lumen: 600</p>	<p>Dim.: 60x110x56 mm Cable length: 400 mm</p>	<p>Type: 3 LED Colour: Black Material/ bracket: Stainless steel Material/dome: Polycarbonate Material/house: Cast aluminum Reflector system: Flood Shape: Rectangular Mount.: Cable Switch: w/o Tightness norm: IP 67 Approval: CE/EMC</p>	
171946 LED Work Lamp		Std pkg 1		
  	<p>Voltage: 10-30 Watt: 18 Kelvin: 6000 Lumen: 1200</p>	<p>Dim.: 60x110x56 mm Cable length: 400 mm</p>	<p>Type: 6 LED Colour: Black Material/ bracket: Stainless steel Material/dome: Polycarbonate Material/house: Cast aluminum Reflector system: Flood Shape: Rectangular Mount.: Cable Switch: w/o Tightness norm: IP 67 Approval: CE/EMC</p>	
171947 LED Work Lamp		Std pkg 1		
  	<p>Voltage: 10-30 Watt: 20 Kelvin: 6000 Lumen: 1600</p>	<p>Dim.: 60x110x56 mm Cable length: 400 mm</p>	<p>Type: 2 LED Colour: Black Material/ bracket: Stainless steel Material/dome: Polycarbonate Material/house: Cast aluminum Reflector system: Flood Shape: Rectangular Mount.: Cable Switch: w/o Tightness norm: IP 67 Approval: CE/EMC</p>	
171948 LED Work Lamp		Std pkg 1		
Handle: HC-CARGO 172008.				
  	<p>Voltage: 10-30 Watt: 15 Kelvin: 6000 Lumen: 1100</p>	<p>Dim.: 128x110x45 mm Cable length: 400 mm</p>	<p>Type: 5 LED Colour: Black Material/ bracket: Stainless steel Material/dome: Polycarbonate Material/house: Cast aluminum Reflector system: Flood Shape: Square Mount.: Cable Switch: w/o Tightness norm: IP 67 Approval: CE/EMC Alternativ no.: 172119</p>	

171949 LED Work Lamp Std pkg 1

Handle: HC-CARGO 172008.

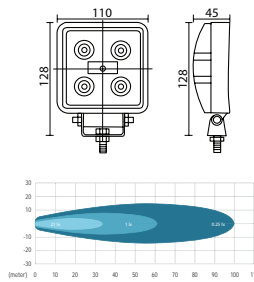

Voltage: 10-30
Watt: 15
Kelvin: 6000
Lumen: 1100

Dim.: 128x110x45 mm
Cable length: 400 mm

Type: 5 LED
Colour: Black
Material/ bracket: Stainless steel
Material/dome: Polycarbonate
Material/house: Cast aluminum
Reflector system: Spot
Shape: Square
Mount.: Cable
Switch: w/o
Tightness norm: IP 67
Approval: CE/EMC

171950 LED Work Lamp Std pkg 1

Handle: HC-CARGO 172008.

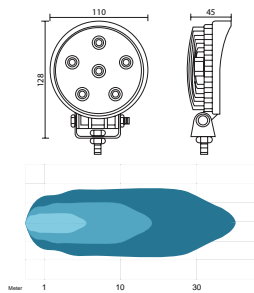

Voltage: 10-30
Watt: 18
Kelvin: 6000
Lumen: 1200

Dim.: 128x110x45 mm
Cable length: 400 mm

Type: 6 LED
Colour: Black
Material/ bracket: Stainless steel
Material/dome: Polycarbonate
Material/house: Cast aluminum
Reflector system: Flood
Shape: Round
Mount.: Cable
Switch: w/o
Tightness norm: IP 67
Approval: CE/EMC
Alternativ no.: 172120

171951 LED Work Lamp Std pkg 1

Handle: HC-CARGO 172008.

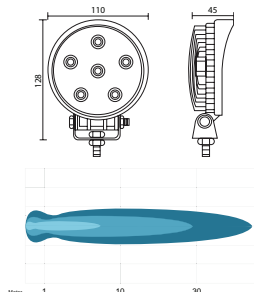

Voltage: 10-30
Watt: 18
Kelvin: 6000
Lumen: 1200

Dim.: 128x110x45 mm
Cable length: 400 mm

Type: 6 LED
Colour: Black
Material/ bracket: Stainless steel
Material/dome: Polycarbonate
Material/house: Cast aluminum
Reflector system: Spot
Shape: Round
Mount.: Cable
Switch: w/o
Tightness norm: IP 67
Approval: CE/EMC

171955 LED Work Lamp Std pkg 1

Accessories: HC-CARGO 190252, 190261, 191029, 193010. Bracket: HC-CARGO 172005.

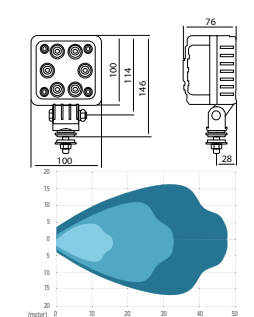

Voltage: 12-24
Watt: 24
Kelvin: 5000-7000
Lumen: 1500

Dim.: 100x100x76 mm

Type: 6 LED
Inclination/downwards: 80°
Inclination/upwards: 90°
Inclination/sideways: 180°
Colour: Black
Material/dome: Plastic
Material/house: ABS plastic/aluminium
Reflector system: Flood
Shape: Square
Switch: w/o
2 poles: w/
Tightness norm: IP 69K
Approval: CE/EMC

172001 LED Work Lamp Std pkg 1

Handle: HC-CARGO 172008.

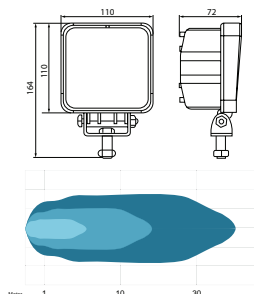

Voltage: 10-80
Watt: 48
Kelvin: 6000
Lumen: 3500

Dim.: 164x110x72 mm
Cable length: 400 mm

Type: 16 LED
Colour: Black
Material/ bracket: Stainless steel
Material/dome: Polycarbonate
Material/house: Cast aluminum
Reflector system: Flood
Shape: Square
Mount.: Cable
Switch: w/o
2 poles: w/
Tightness norm: IP 67
Approval: CE/EMC

172003 LED Work Lamp Std pkg 1

Bracket: HC-CARGO 172005.

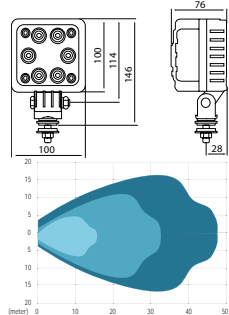

Voltage: 12-24
Watt: 24
Kelvin: 5000-7000
Lumen: 1500

Dim.: 100x100x76 mm
Cable length: 500 mm

Type: 6 LED
Inclination/downwards: 80°
Inclination/upwards: 90°
Inclination/sideways: 180°
Colour: Black
Material/dome: Plastic
Material/house: ABS plastic/aluminium
Reflector system: Flood
Shape: Square
Switch: w/
Tightness norm: IP 69K
Approval: CE/EMC

172004 LED Work Lamp Std pkg 1

Bracket: HC-CARGO 172005.

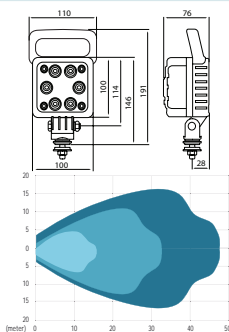

Voltage: 12-24
Watt: 24
Kelvin: 5000-7000
Lumen: 1500

Dim.: 205x110x76 mm
Cable length: 500 mm

Type: 6 LED
Inclination/downwards: 80°
Inclination/upwards: 90°
Inclination/sideways: 180°
Colour: Black
Material/dome: Plastic
Material/house: ABS plastic/aluminium
Reflector system: Flood
Shape: Square
Switch: w/
Handle: w/
Tightness norm: IP 69K
Approval: CE/EMC

172010 LED Work Lamp Std pkg 1

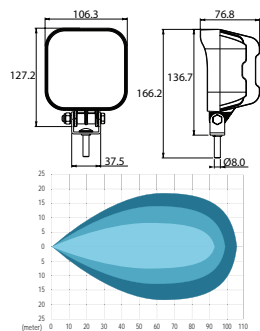

Voltage: 12-36
Watt: 40
Lumen: 3200

Dim.: 127.2x106.3x76.8 mm
Cable length: 280 mm

Type: 4 LED
Colour: Black
Material/house: Aluminium
Reflector system: Flood
Shape: Square
Switch: w/o
Mount. bracket: U-bracket w/ 1 bolt
Tightness norm: IP 69K
Approval: CE/EMC
Alternativ no.: 171932, 172129

172031 LED Work Lamp Std pkg 1

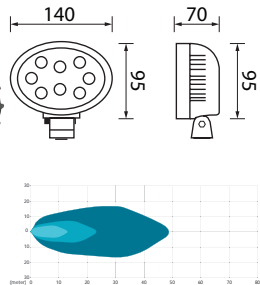

Voltage: 10-80
Watt: 24
Kelvin: 6000
Lumen: 1920

Dim.: 140x95x70 mm
Cable length: 400 mm

Type: 8 LED
Material/dome: Acrylic
Material/house: Cast aluminum
Reflector system: Flood
Shape: Oval
Switch: w/o
2 poles: w/
Tightness norm: IP 69K
Approval: CE/EMC

172032 LED Work Lamp Std pkg 1

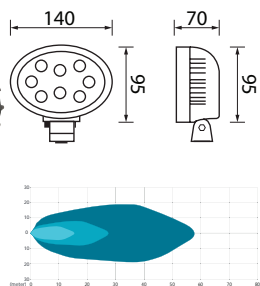

Voltage: 10-80
Watt: 36
Kelvin: 6000
Lumen: 2880

Dim.: 140x95x70 mm
Cable length: 400 mm

Type: 12 LED
Material/dome: Acrylic
Material/house: Cast aluminum
Reflector system: Flood
Shape: Oval
Switch: w/o
2 poles: w/
Tightness norm: IP 69K
Approval: CE/EMC

172045 LED Work Lamp

Std pkg 1

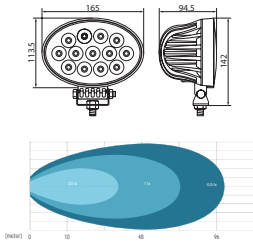

Voltage: 10-80
Watt: 65
Kelvin: 6000
Lumen: 5850

Dim.: 165x142x94.5 mm
Cable length: 500 mm

Type: 13 LED
Colour: Black
Material/ bracket: Stainless steel
Material/dome: Polycarbonate
Material/house: Aluminium
Reflector system: Flood
Shape: Oval
Switch: w/o
2 poles: w/
Tightness norm: IP 69K
Approval: CE/EMC

172046 LED Work Lamp

Std pkg 1

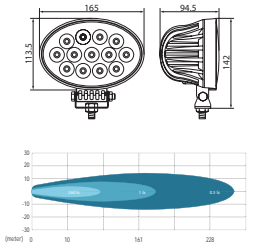

Voltage: 10-80
Watt: 65
Kelvin: 6000
Lumen: 5850

Dim.: 165x142x94.5 mm
Cable length: 500 mm

Type: 13 LED
Colour: Black
Material/ bracket: Stainless steel
Material/dome: Polycarbonate
Material/house: Aluminium
Reflector system: Spot
Shape: Oval
Switch: w/o
2 poles: w/
Tightness norm: IP 69K
Approval: CE/EMC

172055 LED Work Lamp

Std pkg 1

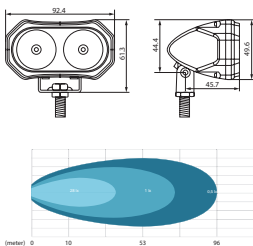

Voltage: 10-80
Amp: 0.83/0.42
Watt: 10
Kelvin: 6000
Lumen: 900

Dim.: 92.4x49.6x45.7 mm
Cable length: 500 mm

Type: 2 LED
Material/ bracket: Stainless steel
Material/dome: Polycarbonate
Material/house: Cast aluminum
Reflector system: Flood
Shape: Rectangular
Switch: w/o
Mount. bracket: U-bracket w/ 1 bolt
2 poles: w/
Tightness norm: IP 69K
Approval: CE

172056 LED Work Lamp

Std pkg 1

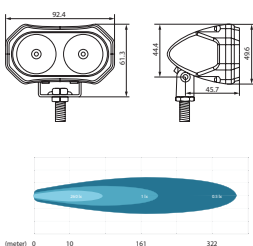

Voltage: 10-80
Amp: 0.83/0.42
Watt: 10
Kelvin: 6000
Lumen: 900

Dim.: 92.4x49.6x45.7 mm
Cable length: 500 mm

Type: 2 LED
Material/ bracket: Stainless steel
Material/dome: Polycarbonate
Material/house: Cast aluminum
Reflector system: Spot
Shape: Rectangular
Switch: w/o
Mount. bracket: U-bracket w/ 1 bolt
2 poles: w/
Tightness norm: IP 69K
Approval: CE

172088 LED Work Lamp

Std pkg 1

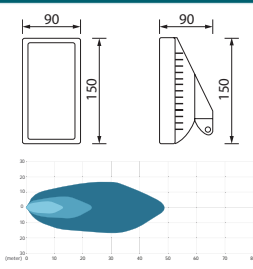

Voltage: 10-30
Watt: 30
Kelvin: 6000
Lumen: 2400

Dim.: 150x90x90 mm
Cable length: 350 mm

Type: 6 LED
Material/dome: Polycarbonate
Material/house: Aluminium
Reflector system: Flood
Shape: Rectangular
Mount.: Sidemounted
Switch: w/o
2 poles: w/
Tightness norm: IP 69K
Approval: CE/EMC

172105 LED Work Lamp



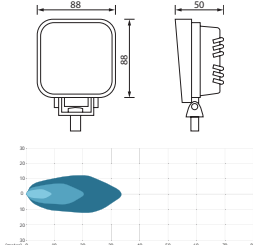





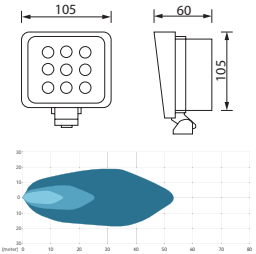

Std pkg 1

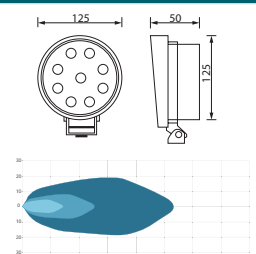

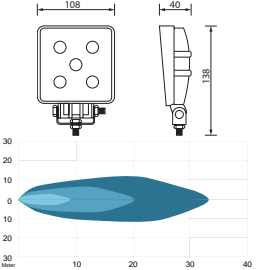
Voltage: 10-30
Watt: 15
Kelvin: 6000
Lumen: 1200

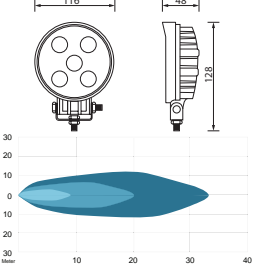
Dim.: 88x88x50 mm
Cable length: 450 mm

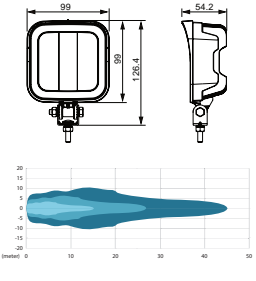
Type: 5 LED
Colour: Black
Material/dome: Polycarbonate
Material/house: Aluminium
Reflector system: Flood
Switch: w/o
Male/female: Male/Female
Tightness norm: IP 69K
Approval: CE/EMC

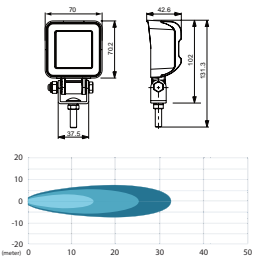
		EL. SPECIFICATIONS	DIMENSIONS	ADDITIONAL SPECIFICATIONS
172106 LED Work Lamp		Std pkg 1		
		Voltage: 10-30 Watt: 27 Kelvin: 6000 Lumen: 2160	Dim.: 105x105x60 mm Cable length: 450 mm	Type: 9 LED Colour: Black Material/dome: Polycarbonate Material/house: Aluminium Reflector system: Flood Switch: w/o Male/female: Male/Female Tightness norm: IP 69K Approval: CE/EMC
172107 LED Work Lamp		Std pkg 1		
		Voltage: 10-30 Watt: 27 Kelvin: 6000 Lumen: 2160	Dim.: 125x125x50 mm Cable length: 450 mm	Type: 9 LED Colour: Black Material/dome: Polycarbonate Material/house: Aluminium Reflector system: Flood Switch: w/o Male/female: Male/Female Tightness norm: IP 69K Approval: CE/EMC
172119 LED Work Lamp		Std pkg 1		
		Voltage: 10-30 Watt: 15 Kelvin: 6000 Lumen: 1100	Dim.: 138x108x40 mm Cable length: 265 mm	Type: 5 LED Colour: Black Material/ bracket: Stainless steel Material/dome: Polycarbonate Material/house: Cast aluminum Reflector system: Flood Shape: Square Switch: w/o Tightness norm: IP 67 Approval: CE/EMC Alternativ no.: 171948
172120 LED Work Lamp		Std pkg 1		
		Voltage: 10-30 Watt: 15 Kelvin: 6000 Lumen: 1100	Dim.: 128x116x48 mm Cable length: 265 mm	Type: 5 LED Colour: Black Material/ bracket: Stainless steel Material/dome: Polycarbonate Material/house: Cast aluminum Reflector system: Flood Shape: Round Switch: w/o Tightness norm: IP 67 Approval: CE/EMC Alternativ no.: 171950
172126 LED Work Lamp		Std pkg 1		
		Voltage: 12-36 Watt: 19.3 Candela: 2000 Lumen: 2160	Dim.: 126.4x99x54.2 mm Cable length: 300 mm	Type: 9 LED Colour: Black Material/dome: Polycarbonate Material/house: Aluminium Reflector system: Flood Shape: Square Switch: w/o Mount. bracket: U-bracket w/ 1 bolt 2 poles: w/ Tightness norm: IP 69K Approval: CE/EMC Alternativ no.: 171751
172127 LED Work Lamp		Std pkg 1		
		Voltage: 12-36 Watt: 8.4 Candela: 1200 Lumen: 720	Dim.: 131.3x70x42.6 mm Cable length: 300 mm	Type: 3 LED Colour: Black Material/ bracket: Stainless steel Material/dome: Polycarbonate Material/house: Shock thermo plastic Reflector system: Flood Shape: Square 2 poles: w/ Tightness norm: IP 67 Approval: CE/EMC

EL. SPECIFICATIONS		DIMENSIONS		ADDITIONAL SPECIFICATIONS	
172128 LED Work Lamp		Std pkg 1			
		Voltage: 12-36 Watt: 22 Lumen: 2160	Dim.: 188.4x125x82 mm Cable length: 280 mm	Type: 9 LED Colour: Red/black Material/ bracket: Stainless steel Material/dome: Polycarbonate Material/house: Aluminium Reflector system: Flood Shape: Square Switch: w/ Handle: w/ 2 poles: w/ Tightness norm: IP 69K Approval: CE/EMC	
172129 LED Work Lamp		Std pkg 1			
		Voltage: 12-36 Watt: 40 Candela: 8000 Lumen: 4800	Dim.: 136.1x110x65.9 mm Cable length: 350 mm	Type: 6 LED Colour: Black Material/ bracket: Stainless steel Material/dome: Polycarbonate Material/house: Aluminium Reflector system: Flood Shape: Square Switch: w/o Mount. bracket: U-bracket w/ 1 bolt 2 poles: w/ Tightness norm: IP 69K Approval: CE/EMC Alternativ no.: 171752, 172010	
172130 LED Work Lamp		Std pkg 1			
		Voltage: 12-36 Watt: 22 Lumen: 1490	Dim.: 75.6x70x57 mm Cable length: 2000 mm	Type: 9 LED Colour: Red/black Material/dome: Polycarbonate Material/house: Aluminium Reflector system: Flood Shape: Square Switch: w/ Magnet base: w/ Coiled cable incl.: Yes Tightness norm: IP 69K Approval: CE/EMC	
172131 LED Work Lamp		Std pkg 1			
		Voltage: 10-60 Watt: 30 Kelvin: 6000 Lumen: 2400	Dim.: 119x105x80 mm Cable length: 460 mm	Type: 6 LED Colour: Black Material/ bracket: Stainless steel Material/dome: Polycarbonate Material/house: Aluminium Reflector system: Spot Shape: Square Tightness norm: IP 69K Approval: CE/EMC	
172132 LED Work Lamp		Std pkg 1			
		Voltage: 10-60 Watt: 35 Kelvin: 6000 Lumen: 2800	Dim.: 119x105x80 mm Cable length: 460 mm	Type: 1 LED Colour: Black Material/ bracket: Stainless steel Material/dome: Polycarbonate Material/house: Aluminium Reflector system: Flood Shape: Square Tightness norm: IP 69K Approval: CE/EMC	
172133 LED Work Lamp		Std pkg 1			
		Voltage: 10-30 Watt: 15 Kelvin: 6000 Lumen: 1200	Dim.: 130x78x53 mm Cable length: 460 mm	Type: 5 LED Colour: Black Material/ bracket: Stainless steel Material/dome: Polycarbonate Material/house: Aluminium Reflector system: Flood Shape: Oval Tightness norm: IP 69K Approval: CE/EMC	

172134 LED Work Lamp Std pkg 1		
	Voltage: 10-30 Watt: 24 Kelvin: 6000 Lumen: 1920	Dim.: 130x78x53 mm Cable length: 460 mm Type: 8 LED Colour: Black Material/ bracket: Stainless steel Material/dome: Polycarbonate Material/house: Aluminium Reflector system: Flood Shape: Oval Tightness norm: IP 69K Approval: CE/EMC

172135 LED Work Lamp Std pkg 1		
	Voltage: 10-60 Watt: 20 Kelvin: 6000 Lumen: 1600	Dim.: 150x40x65 mm Cable length: 460 mm Type: 4 LED Colour: Black Material/ bracket: Stainless steel Material/dome: Polycarbonate Material/house: Aluminium Reflector system: Flood Shape: Oblong 2 poles: w/ Tightness norm: IP 69K Approval: CE/EMC

172136 LED Work Lamp Std pkg 1		
	Voltage: 10-60 Watt: 30 Kelvin: 6000 Lumen: 2400	Dim.: 215x40x65 mm Cable length: 460 mm Type: 6 LED Colour: Black Material/ bracket: Stainless steel Material/dome: Polycarbonate Material/house: Aluminium Reflector system: Flood Shape: Oblong 2 poles: w/ Tightness norm: IP 69K Approval: CE/EMC

172143 LED Work Lamp Std pkg 1		
	Voltage: 10-30 Watt: 15 Kelvin: 6000 Lumen: 1426	Dim.: 150x80x38 mm Type: 10 LED Colour: Black Material/ bracket: Stainless steel Material/dome: Polycarbonate Material/house: Cast aluminum Reflector system: Flood Shape: Rectangular Tightness norm: IP 67 Approval: CE/EMC

172191 LED Work Lamp Std pkg 1 Servicing: John Deere - Visit our web catalogue for further information		
	Voltage: 10-30 Watt: 40 Kelvin: 6000 Lumen: 3200	Dim.: 170x82x80 mm Cable length: 460 mm Type: 8 LED Colour: Black Material/dome: Polycarbonate Material/house: Cast aluminum Reflector system: Flood Shape: Oval Tightness norm: IP 69K Approval: CE/ECE

ACCESSORIES

172005 Bracket Std pkg 1 Servicing: HC-CARGO 171955, 172003, 172004		
		Dim.: 59x37 mm Mount. hole size: 24 mm Material: Plastic Mount.: Standard ISO A - Rod

172008 Handle for LED Work Lamp Std pkg 1 Servicing: HC-CARGO 171948, 171949, 171950, 171951, 172001



Colour: Black
Material/ bracket: Aluminium
Mount. bracket: 2 screws

WORK LIGHT BARS LED

170098 LED Work light bar Std pkg 1

DT Connector: HC-CARGO 193365, 193366. Mounting Bracket Kit: HC-CARGO 172201, 172202.

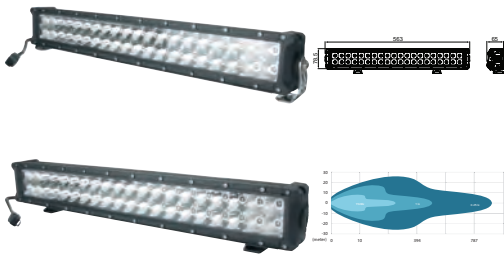

Voltage: 10-30
Watt: 120
Kelvin: 6000
Lumen: 10800

Dim.: 563x78x65 mm
Cable length: 500 mm

Type: 40 LED
Colour: Black
Material/ bracket: Aluminium
Material/dome: Polycarbonate
Material/house: Cast aluminum
Reflector system: Combo
Shape: Straight
Mount. bracket: Sidemounted/Plan installation
Male/female: Male/Female
Tightness norm: IP 67
Approval: CE/ECE

170099 LED Work light bar Std pkg 1

ATP Connector: HC-CARGO 193367, 193368. Mounting Bracket Kit: HC-CARGO 172201, 172202.



Voltage: 10-30
Watt: 180
Kelvin: 6000
Lumen: 16200

Dim.: 818x78x65 mm
Cable length: 500 mm

Type: 60 LED
Colour: Black
Material/ bracket: Aluminium
Material/dome: Polycarbonate
Material/house: Cast aluminum
Reflector system: Combo
Shape: Straight
Mount. bracket: Sidemounted/Plan installation
Male/female: Male/Female
Tightness norm: IP 67
Approval: CE/ECE

170100 LED Work light bar Std pkg 1

ATP Connector: HC-CARGO 193367, 193368. Mounting Bracket Kit: HC-CARGO 172201, 172202.



Voltage: 10-30
Watt: 240
Kelvin: 6000
Lumen: 21600

Dim.: 1073x78x65 mm
Cable length: 500 mm

Type: 80 LED
Colour: Black
Material/ bracket: Aluminium
Material/dome: Polycarbonate
Material/house: Cast aluminum
Reflector system: Combo
Shape: Straight
Mount. bracket: Sidemounted/Plan installation
Male/female: Male/Female
Tightness norm: IP 67
Approval: CE/ECE

170101 LED Work light bar Std pkg 1





ATP Connector: HC-CARGO 193367, 193368. Mounting Bracket Kit: HC-CARGO 172201, 172202.

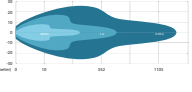
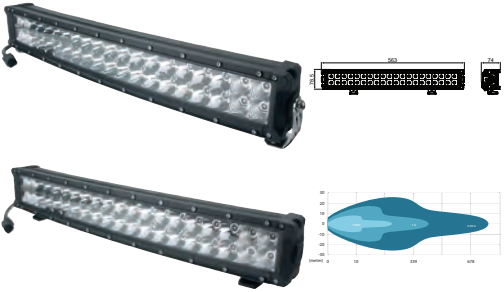
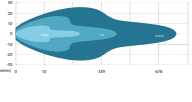

Voltage: 10-30
Watt: 288
Kelvin: 6000
Lumen: 25920

Dim.: 1273x78x65 mm
Cable length: 500 mm

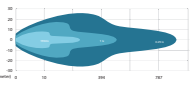
Type: 96 LED
Colour: Black
Material/ bracket: Aluminium
Material/dome: Polycarbonate
Material/house: Cast aluminum
Reflector system: Combo
Shape: Straight
Mount. bracket: Sidemounted/Plan installation
Male/female: Male/Female
Tightness norm: IP 67
Approval: CE/ECE

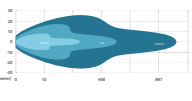
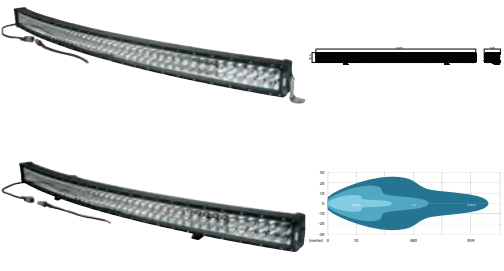
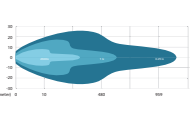
170102 LED Work light bar		Std pkg 1	
<i>ATP Connector: HC-CARGO 193367, 193368. Mounting Bracket Kit: HC-CARGO 172201, 172202.</i>			
	Voltage: 10-30 Watt: 300 Kelvin: 6000 Lumen: 27000	Dim.: 1326x78x65 mm Cable length: 500 mm	Type: 100 LED Colour: Black Material/ bracket: Aluminium Material/dome: Polycarbonate Material/house: Cast aluminum Reflector system: Combo Shape: Straight Mount. bracket: Sidemounted/Plan installation Male/female: Male/Female Tightness norm: IP 67 Approval: CE/ECE
			
170103 LED Work light bar		Std pkg 1	
<i>DT Connector: HC-CARGO 193365, 193366. Mounting Bracket Kit: HC-CARGO 172201, 172202.</i>			
	Voltage: 10-30 Amp: 6.6/3.4 Watt: 120 Lumen: 10800	Dim.: 563x74x78.5 mm Cable length: 500 mm	Type: 40 LED Colour: Black Material/ bracket: Aluminium Material/dome: Polycarbonate Material/house: Cast aluminum Reflector system: Combo Shape: Curved Mount. bracket: Sidemounted/Plan installation Male/female: Male/Female Tightness norm: IP 67 Approval: CE/ECE Alternativ no.: 172077
			
170104 LED Work light bar		Std pkg 1	
<i>ATP Connector: HC-CARGO 193367, 193368. Mounting Bracket Kit: HC-CARGO 172201, 172202.</i>			
	Voltage: 10-30 Amp: 9.28/4.62 Watt: 180 Lumen: 16200	Dim.: 818x87x78.5 mm Cable length: 500 mm	Type: 60 LED Colour: Black Material/ bracket: Aluminium Material/dome: Polycarbonate Material/house: Cast aluminum Reflector system: Combo Shape: Curved Mount. bracket: Sidemounted/Plan installation Male/female: Male/Female Tightness norm: IP 67 Approval: CE/ECE Alternativ no.: 172078
			
170105 LED Work light bar		Std pkg 1	
<i>ATP Connector: HC-CARGO 193367, 193368. Mounting Bracket Kit: HC-CARGO 172201, 172202.</i>			
	Voltage: 10-30 Amp: 12.8/6.35 Watt: 240 Lumen: 21600	Dim.: 1073x108x78.5 mm Cable length: 500 mm	Type: 80 LED Colour: Black Material/ bracket: Aluminium Material/dome: Polycarbonate Material/house: Cast aluminum Reflector system: Combo Shape: Curved Mount. bracket: Sidemounted/Plan installation Male/female: Male/Female Tightness norm: IP 67 Approval: CE/ECE Alternativ no.: 172079
			
170106 LED Work light bar		Std pkg 1	
<i>ATP Connector: HC-CARGO 193367, 193368. Mounting Bracket Kit: HC-CARGO 172201, 172202.</i>			
	Voltage: 10-30 Amp: 16.08/7.83 Watt: 288 Lumen: 25920	Dim.: 1273x128x78.5 mm Cable length: 500 mm	Type: 96 LED Colour: Black Material/ bracket: Aluminium Material/dome: Polycarbonate Material/house: Cast aluminum Reflector system: Combo Shape: Curved Mount. bracket: Sidemounted/Plan installation Male/female: Male/Female Tightness norm: IP 67 Approval: CE/ECE Alternativ no.: 172080
			

170107 LED Work light bar Std pkg 1

ATP Connector: HC-CARGO 193367, 193368. Mounting Bracket Kit: HC-CARGO 172201, 172202.

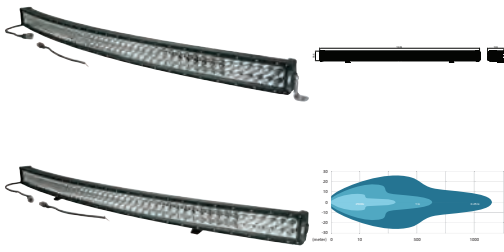

Voltage: 10-30
Amp: 18.8/9.4
Watt: 300
Lumen: 27000

Dim.: 1326x133x78.5 mm
Cable length: 500 mm

Type: 100 LED
Colour: Black
Material/ bracket: Aluminium
Material/dome: Polycarbonate
Material/house: Cast aluminum
Reflector system: Combo
Shape: Curved
Mount. bracket: Sidemounted/Plan installation
Male/female: Male/Female
Tightness norm: IP 67
Approval: CE/ECE

172077 LED Work light bar Std pkg 1

Mounting Bracket Kit: HC-CARGO 172116. DT Connector: HC-CARGO 193365, 193366.

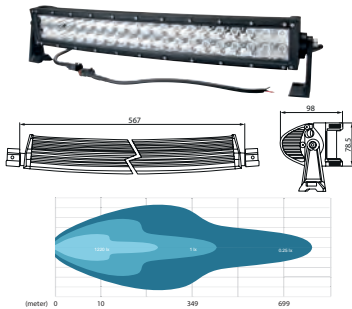

Voltage: 10-30
Watt: 120
Kelvin: 6000
Lumen: 10800

Dim.: 567x98x78.5 mm
Cable length: 1000 mm

Type: 40 LED
Colour: Black
Material/ bracket: Aluminium
Material/dome: Polycarbonate
Material/house: Aluminium
Reflector system: Combo
Shape: Curved
Switch: w/o
Mount. bracket: Vertical
Male/female: Male/Female
Tightness norm: IP 67
Approval: CE/EMC
E-approval: No
Alternativ no.: 170103

172078 LED Work light bar Std pkg 1

Mounting Bracket Kit: HC-CARGO 172116. ATP Connector: HC-CARGO 193367, 193368.

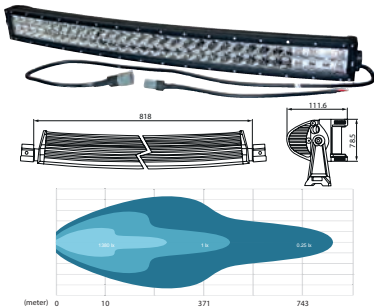

Voltage: 10-30
Watt: 180
Kelvin: 6000
Lumen: 16200

Dim.: 818x111.6x78.5 mm
Cable length: 1000 mm

Type: 60 LED
Colour: Black
Material/ bracket: Aluminium
Material/dome: Polycarbonate
Material/house: Aluminium
Reflector system: Combo
Shape: Curved
Switch: w/o
Mount. bracket: Vertical
Male/female: Male/Female
Tightness norm: IP 67
Approval: CE/EMC
E-approval: No
Alternativ no.: 170104

172079 LED Work light bar Std pkg 1

Mounting Bracket Kit: HC-CARGO 172116. ATP Connector: HC-CARGO 193367, 193368.

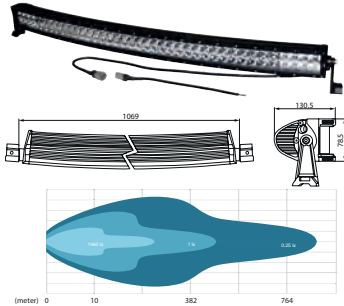

Voltage: 10-30
Watt: 240
Kelvin: 6000
Lumen: 21600

Dim.: 1069x130.5x78.5 mm
Cable length: 1000 mm

Type: 80 LED
Colour: Black
Material/ bracket: Aluminium
Material/dome: Polycarbonate
Material/house: Aluminium
Reflector system: Combo
Shape: Curved
Mount. bracket: Vertical
Male/female: Male/Female
Tightness norm: IP 67
Approval: CE/EMC
E-approval: No
Alternativ no.: 170105

172080 LED Work light bar Std pkg 1

Mounting Bracket Kit: HC-CARGO 172116. ATP Connector: HC-CARGO 193367, 193368.

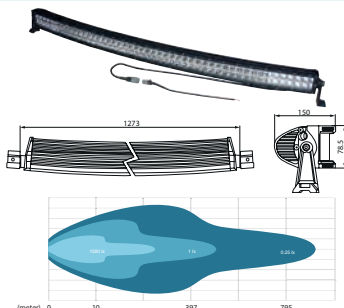

Voltage: 10-30
Watt: 288
Kelvin: 6000
Lumen: 25920

Dim.: 1273x150x78.5 mm
Cable length: 1000 mm

Type: 96 LED
Colour: Black
Material/ bracket: Aluminium
Material/dome: Polycarbonate
Material/house: Aluminium
Reflector system: Combo
Shape: Curved
Mount. bracket: Vertical
Male/female: Male/Female
Tightness norm: IP 67
Approval: CE/EMC
E-approval: No
Alternativ no.: 170106

172081 LED Work light bar		Std pkg 1	
<i>DT Connector: HC-CARGO 193365, 193366.</i>			
	<p>Voltage: 10-30 Watt: 18 Kelvin: 6000 Lumen: 1620</p>	<p>Dim.: 276x56.6x56.5 mm Cable length: 500 mm</p>	<p>Type: 6 LED Colour: Black Material/ bracket: Aluminium Material/dome: Polycarbonate Material/house: Aluminium Reflector system: Spot Shape: Straight Mount. bracket: Vertical Male/female: Male/Female Tightness norm: IP 67 Approval: CE/EMC E-approval: No</p>
172082 LED Work light bar		Std pkg 1	
<i>DT Connector: HC-CARGO 193365, 193366.</i>			
	<p>Voltage: 10-30 Watt: 36 Kelvin: 6000 Lumen: 3240</p>	<p>Dim.: 516x56.5x56.5 mm Cable length: 500 mm</p>	<p>Type: 12 LED Colour: Black Material/ bracket: Aluminium Material/dome: Polycarbonate Material/house: Aluminium Reflector system: Combo Shape: Straight Mount. bracket: Vertical Male/female: Male/Female Tightness norm: IP 67 Approval: CE/EMC E-approval: No</p>
172083 LED Work light bar		Std pkg 1	
<i>DT Connector: HC-CARGO 193365, 193366.</i>			
	<p>Voltage: 10-30 Watt: 54 Kelvin: 6000 Lumen: 4860</p>	<p>Dim.: 756x56.5x56.5 mm Cable length: 500 mm</p>	<p>Type: 18 LED Colour: Black Material/ bracket: Aluminium Material/dome: Polycarbonate Material/house: Aluminium Reflector system: Combo Shape: Straight Mount. bracket: Vertical Male/female: Male/Female Tightness norm: IP 67 Approval: CE/EMC E-approval: No</p>
172084 LED Work light bar		Std pkg 1	
<i>DT Connector: HC-CARGO 193365, 193366.</i>			
	<p>Voltage: 10-30 Watt: 72 Kelvin: 6000 Lumen: 6480</p>	<p>Dim.: 996x56.5x56.5 mm Cable length: 500 mm</p>	<p>Type: 24 LED Colour: Black Material/ bracket: Aluminium Material/dome: Polycarbonate Material/house: Aluminium Reflector system: Combo Shape: Straight Mount. bracket: Vertical Male/female: Male/Female Tightness norm: IP 67 Approval: CE/EMC E-approval: No</p>
172095 LED Work light bar		Std pkg 1	
	<p>Voltage: 10-30 Amp: 3.2/1.6 Watt: 50 Kelvin: 6000 Lumen: 4000</p>	<p>Dim.: 255x80x41 mm Cable length: 500 mm</p>	<p>Type: 10 LED Inclination/downwards: 90° Inclination/upwards: 15° Colour: Black Material/ bracket: Stainless steel Material/dome: Polycarbonate Material/house: Aluminium Reflector system: Spot Shape: Straight Mount.: Upright/pendant Mount. bracket: Sidemounted Male/female: Male/Female Tightness norm: IP 67 Approval: CE/EMC E-approval: No</p>

EL. SPECIFICATIONS

DIMENSIONS

ADDITIONAL SPECIFICATIONS

172096 LED Work light bar Std pkg 1

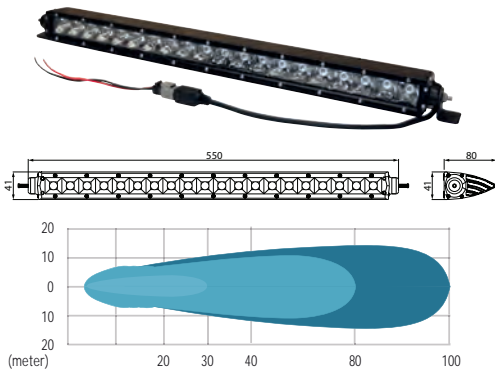

Voltage: 10-30
Amp: 6.25/3.125
Watt: 100
Kelvin: 6000
Lumen: 8000

Dim.: 550x80x41 mm
Cable length: 500 mm

Type: 20 LED
Inclination/downwards: 90°
Inclination/upwards: 15°
Colour: Black
Material/ bracket: Stainless steel
Material/dome: Polycarbonate
Material/house: Aluminium
Reflector system: Spot
Shape: Straight
Mount.: Upright/pendant
Mount. bracket: Sidemounted
Male/female: Male/Female
Tightness norm: IP 67
Approval: CE/EMC
E-approval: No

172097 LED Work light bar Std pkg 1

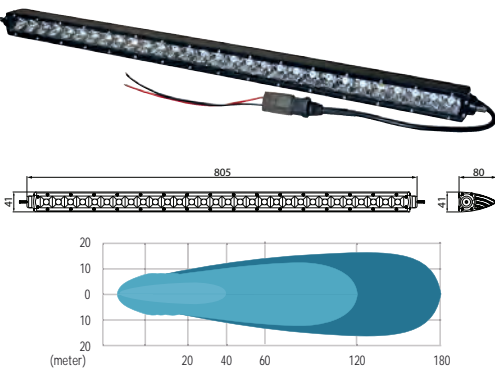

Voltage: 10-30
Amp: 9.45/4.7
Watt: 150
Kelvin: 6000
Lumen: 12000

Dim.: 805x80x41 mm
Cable length: 500 mm

Type: 30 LED
Inclination/downwards: 90°
Inclination/upwards: 15°
Colour: Black
Material/ bracket: Stainless steel
Material/dome: Polycarbonate
Material/house: Aluminium
Reflector system: Spot
Shape: Straight
Mount.: Upright/pendant
Mount. bracket: Sidemounted
Male/female: Male/Female
Tightness norm: IP 67
Approval: CE/EMC
E-approval: No

172098 LED Work light bar Std pkg 1

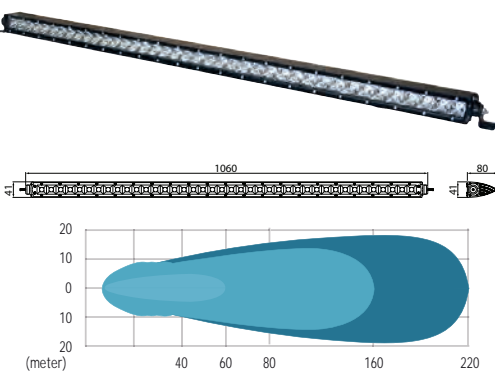

Voltage: 10-30
Amp: 12.5/6.25
Watt: 200
Kelvin: 6000
Lumen: 16000

Dim.: 1060x80x41 mm
Cable length: 500 mm

Type: 40 LED
Inclination/downwards: 90°
Inclination/upwards: 15°
Colour: Black
Material/ bracket: Stainless steel
Material/dome: Polycarbonate
Material/house: Aluminium
Reflector system: Spot
Shape: Straight
Mount.: Upright/pendant
Mount. bracket: Sidemounted
Male/female: Male/Female
Tightness norm: IP 67
Approval: CE/EMC
E-approval: No

SPARE PARTS

172116 Mounting Bracket Kit Std pkg 1 Servicing: HC-CARGO 172077, 172078, 172079, 172080



172201 Mounting Bracket Kit Std pkg 1 Servicing: HC-CARGO 170098, 170099, 170100, 170101, 170102, 170103, 170104, 170105, 170106, 172107

Plan installation.

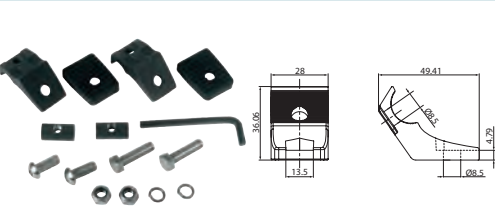

Total length: 49.41 mm
Height: 36.06 mm
Width: 28 mm

172202 Mounting Bracket Kit Std pkg 1		Servicing: HC-CARGO 170098, 170099, 170100, 170101, 170102, 170103, 170104, 170105, 170106, 172107		
<i>Sidemounted.</i>				
		Total length: 33 mm Height: 61.5 mm Width: 38.09 mm		
193365 DT Connector Std pkg 1		Servicing: HC-CARGO 172077, 172081, 172082, 172083, 172084, 172092, 172093, 172102		
		Cable length: 300 mm Male/female: Male		
193366 DT Connector Std pkg 1		Servicing: HC-CARGO 172077, 172081, 172082, 172083, 172084, 172092, 172093, 172102		
		Cable length: 130 mm Male/female: Female		
193367 ATP Connector Std pkg 1		Servicing: HC-CARGO 172078, 172079, 172080		
		Male/female: Male		
193368 ATP Connector Std pkg 1		Servicing: HC-CARGO 172078, 172079, 172080		
		Male/female: Female		
SPOT LIGHTS LED				
172053 LED Blue Spot Std pkg 1		Voltage: 10-80 Amp: 0.5/0.25 Watt: 6 Lumen: 540		
		Dim.: 92.4x49.6x45.7 mm Cable length: 500 mm		
		Type: 2 LED Colour: Blue Material/ bracket: Stainless steel Material/dome: Polycarbonate Material/house: Cast aluminum Shape: Rectangular Switch: w/o Mount. bracket: U-bracket w/ 1 bolt 2 poles: w/ Tightness norm: IP 69K Approval: CE		
172054 LED Red Spot Std pkg 1		Voltage: 10-80 Amp: 0.5/0.25 Watt: 6 Lumen: 540		
		Dim.: 92.4x49.6x45.7 mm Cable length: 500 mm		
		Type: 2 LED Colour: Red Material/ bracket: Stainless steel Material/dome: Polycarbonate Material/house: Cast aluminum Shape: Rectangular Switch: w/o Mount. bracket: U-bracket w/ 1 bolt 2 poles: w/ Tightness norm: IP 69K Approval: CE		

172185 LED Blue Light

Std pkg 1

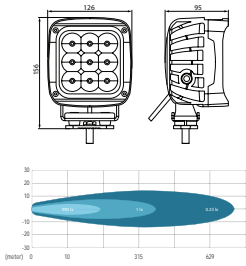

Voltage: 10-30
Amp: 2.14/1.07
Watt: 45
Lumen: 4050

Dim.: 156x126x95 mm

Type: 10 LED
Colour: Blue
Material/ bracket: Stainless steel
Material/dome: Polycarbonate
Material/house: Cast aluminum
Shape: Rectangular
Switch: w/o
Mount. bracket: U-bracket w/ 1 bolt
2 poles: w/
Tightness norm: IP 67
Approval: CE

**SEARCH LIGHTS
CONVENTIONAL**

170293 Spot Light

Std pkg 1

Hand-held.

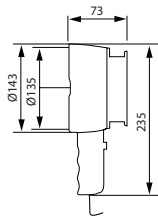

Bulb incl.: Yes
Voltage: 12
Watt: 55

Dim.: 235x73 mm
Cable length: 6000 mm
Light aperture:
120 mm

Bulb type: H3
Socket type: PK22s
Colour: Black
Material: Shockproof plastic
Shape: Round
Switch: w/
Protective cover: w/

170564 Spot Light

Std pkg 1

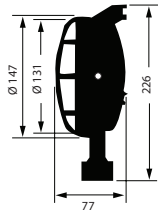

Bulb incl.: No

Dim.: 226x77 mm
Light aperture:
131 mm

Type: H3
Socket type: PK22s
Inclination/sideways: Yes
Colour: Black
Material/dome: Glass
Material/house: Shockproof plastic
Switch: w/
Grill: w/
Handle: w/

171464 Spot Light

Std pkg 1

Remote controlled by EU approved radio controller. Frequency 433.92 MHZ. Reach up to 100 m. Incl. 9 V battery. Battery: HC-CARGO 200742, 200769.

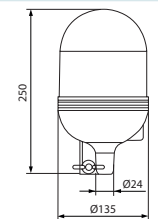

Bulb incl.: Yes
Voltage: 12
Amp: 4.6
Watt: 55

Dim.: 250x135 mm
OD: 135 mm

Bulb type: H1
Material: Shockproof plastic
Material/dome: Polycarbonate
Mount.: Standard ISO A - Rod
Tightness norm: IP 55
Approval: CE

171466 Spot Light

Std pkg 1

Remote controlled by EU approved radio controller. Frequency 433.92 MHZ. Reach up to 100 m. Incl. 9 V battery. Battery: HC-CARGO 200742, 200769. Beacon Socket: HC-CARGO 170653.

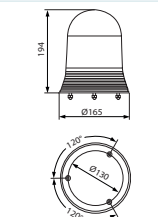

Bulb incl.: Yes
Voltage: 12
Amp: 4.6
Watt: 55

Dim.: 194x165 mm
OD: 160 mm

Bulb type: H1
Colour: Black
Material: Shockproof plastic
Material/dome: Polycarbonate
Mount.: Standard ISO B2 (and B1) - Base
Tightness norm: IP 55

ACCESSORIES

170653 Beacon Socket

Std pkg 1

Servicing: HC-CARGO 170650, 170651, 171466

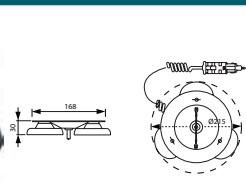

Cable length: 2000 mm
Height: 30 mm
Width: 168 mm

Mount.: 3 magnets
Base: Magnetic
Coiled cable incl.: Yes
Tightness norm: IP 55
E-approval: Yes

171936 Magnetic base for Lamps

Std pkg 1

Servicing: HC-CARGO 170534



Coiled cable: 2000 mm

Colour: Black
Mount.: Magnetic
Mount. bracket: U-bracket w/ 2 holes
Magnet base: w/
Lighter plug incl.: Yes
Coiled cable incl.: Yes

FORWARD LIGHTING

TRACTOR HEAD LAMPS

170132 Head Lamp

Std pkg 1

Light unit: HC-CARGO 170239.

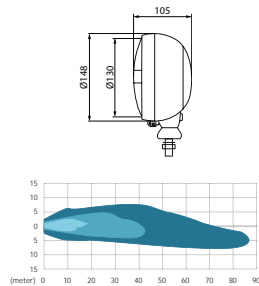

Bulb incl.: No
Watt: 45/40
Watt 2: 55/50
Watt 3: 4

Dim.: 148x105 mm
Light aperture:
130 mm

Socket type: P45t
Socket type 2: P45t
Socket type 3: BA9s
Colour: Black
Material: Metal
Material/dome: Glass
Shape: Round
Mount.: 1 bolt
Sidemarker: w/
Grill: w/o
Asymmetric light: w/
RH/LH: LH
E-approval: Yes

170310 Head Lamp

Std pkg 1

For upright fixing.

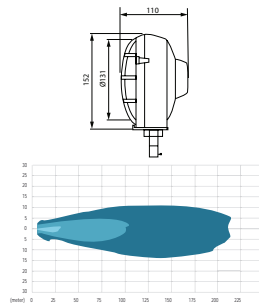

Bulb incl.: No
Watt: 45/40
Watt 2: 55/50
Watt 3: 4

Dim.: 152x110 mm
Light aperture:
131 mm

Socket type: P45t
Socket type 2: P45t
Socket type 3: BA9s
Colour: Black
Material: Plastic
Material/dome: Glass
Shape: Round
Mount.: Vertical
Sidemarker: w/
Grill: w/
Asymmetric light: w/
RH/LH: RH/LH
E-approval: Yes

170311 Head Lamp

Std pkg 1

Horizontal fixing.

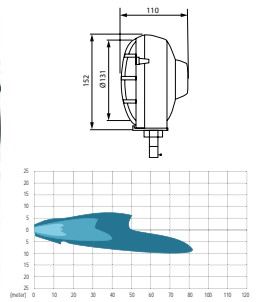

Bulb incl.: No
Watt: 45/40
Watt 2: 55/50
Watt 3: 4

Dim.: 152x110 mm
Light aperture:
131 mm

Socket type: P45t
Socket type 2: P45t
Socket type 3: BA9s
Colour: Black
Material: Plastic
Material/dome: Glass
Shape: Round
Mount.: Horizontal
Sidemarker: w/
Grill: w/
Asymmetric light: w/
RH/LH: LH
E-approval: Yes

170843 Head Lamp

Std pkg 1

Light unit: HC-CARGO 170844.

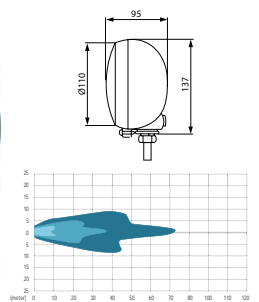

Bulb incl.: No
Watt: 45/40
Watt 2: 55/50
Watt 3: 4

Dim.: 137x95 mm
Light aperture:
110 mm

Socket type: BA20d
Socket type 2: BA20d
Socket type 3: BA9s
Colour: Black
Material: Metal
Material/dome: Glass
Shape: Round
Mount.: 1 bolt
Sidemarker: w/
Grill: w/o
Asymmetric light: w/o
RH/LH: RH/LH
E-approval: Yes

170865 Head Lamp

Std pkg 1

Servicing: Zetor: Model 2002, Proxima, Forterra, Super, Super Eko, Classic Eko - Visit our web catalogue for further information

Bulb Gasket: HC-CARGO 171937.

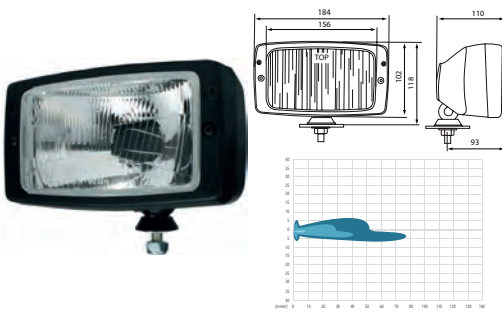

Bulb incl.: No
Watt: 60/55
Watt 2: 75/70

Dim.: 184x118x110 mm
Light aperture:
156 mm

Bulb type: H4
Bulb type 2: H4
Socket type: P43t
Socket type 2: P43t
Colour: Black
Material: Shockproof plastic
Material/dome: Glass
Shape: Rectangular
Mount.: Horizontal
Asymmetric light: w/
RH/LH: LH
E-approval: Yes

170974 Head Lamp

Std pkg 1

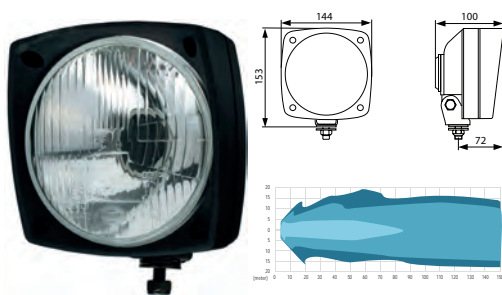

Bulb incl.: No
Watt: 60/65
Watt 2: 75/70

Dim.: 144x153x100 mm
Light aperture:
110 mm

Bulb type: H4
Bulb type 2: H4
Socket type: P43t
Socket type 2: P43t
Colour: Black
Material: Shockproof plastic
Material/dome: Glass
Shape: Rectangular
Mount.: Horizontal/vertical
Asymmetric light: w/
RH/LH: LH
E-approval: Yes

171006 Head Lamp

Std pkg 1

Light unit: HC-CARGO 171007. Lens: HC-CARGO 171008.

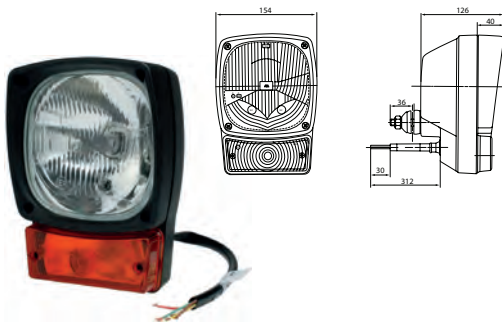

Bulb incl.: Yes
Voltage: 12
Watt: 60/55
Watt 2: 75/70

Dim.: 208x154x126 mm
Light aperture:
142 mm

Bulb type: H4
Bulb type 2: H4
Socket type: P43t
Socket type 2: P43t
Colour: Black
Material: Shockproof plastic
Material/dome: Glass
Shape: Rectangular
Mount.: Horizontal/vertical
Flasher light: w/
Sidemarker: w/
Asymmetric light: w/
RH/LH: RH/LH
E-approval: Yes

171038 Head Lamp

Std pkg 1

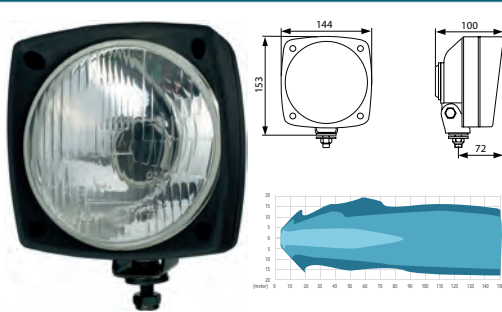

Bulb incl.: No
Watt: 60/65
Watt 2: 75/70
Watt 3: 4

Dim.: 144x153x100 mm
Light aperture:
110 mm

Bulb type: H4
Bulb type 2: H4
Socket type: P43t
Socket type 2: P43t
Socket type 3: BA9s
Colour: Black
Material: Shockproof plastic
Material/dome: Glass
Shape: Rectangular
Mount.: Horizontal/vertical
Sidemarker: w/
Asymmetric light: w/
RH/LH: LH
E-approval: Yes

171565 Head Lamp

Std pkg 1

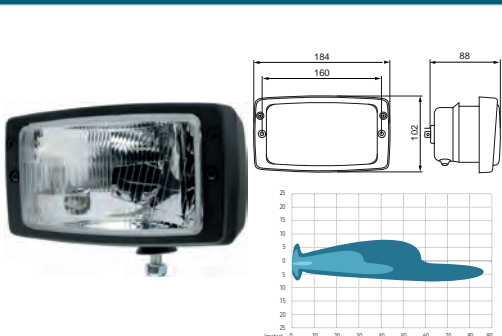

Bulb incl.: No
Watt: 60/55
Watt 2: 75/70
Watt 3: 4

Dim.: 184x102x88 mm
Light aperture:
160 mm

Bulb type: H4
Bulb type 2: H4
Socket type: P43t
Socket type 2: P43t
Socket type 3: BA9s
Colour: Black
Material: Shockproof plastic
Material/dome: Glass
Shape: Square
Mount.: Horizontal/vertical
Sidemarker: w/
Grill: w/o
Asymmetric light: w/
RH/LH: RH/LH
E-approval: Yes

172192 Head Lamp Std pkg 1

DT Connector: HC-CARGO 193355.

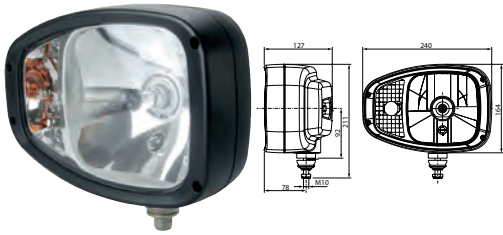

Bulb incl.: Yes
Voltage: 12/24
Watt: 60/55
Watt 2: 5
Watt 3: 21

Dim.: 240x164x127 mm

Bulb type: H4
Bulb type 2: W5W
Bulb type 3: PY21W
Socket type: P43t
Socket type 2: T10
Socket type 3: BAU15s
Colour: Black
Material: Shockproof plastic
Material/dome: Glass
Flasher light: w/
Sidemarker: w/
RH/LH: RH
Approval: SAE/ECE
E-approval: Yes

172193 Head Lamp Std pkg 1

DT Connector: HC-CARGO 193355.



Bulb incl.: Yes
Voltage: 12/24
Watt: 60/55
Watt 2: 5
Watt 3: 21

Dim.: 240x164x127 mm

Bulb type: H4
Bulb type 2: W5W
Bulb type 3: PY21W
Socket type: P43t
Socket type 2: T10
Socket type 3: BAU15s
Colour: Black
Material: Shockproof plastic
Material/dome: Glass
Flasher light: w/
Sidemarker: w/
RH/LH: LH
Approval: SAE/ECE
E-approval: Yes

SPARE PARTS

170239 Light Unit Std pkg 1 Servicing: HC-CARGO 170132

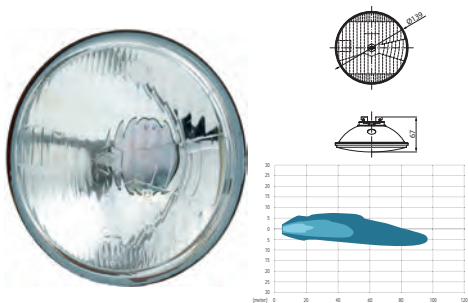

Bulb incl.: No
Watt: 45/40
Watt 2: 55/50
Watt 3: 4

Dim.: 139x67 mm
Light aperture:
130 mm

Socket type: P45t
Socket type 2: P45t
Socket type 3: BA9s
Material: Glass
Shape: Round
Sidemarker: w/
Asymmetric light: w/
RH/LH: LH
E-approval: Yes

170844 Light Unit Std pkg 1 Servicing: HC-CARGO 170843

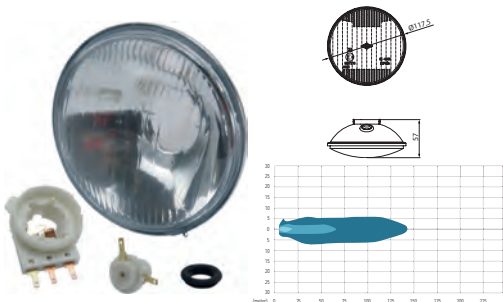

Bulb incl.: No
Watt: 45/40
Watt 2: 55/50
Watt 3: 4

Dim.: 117.5x57 mm
Light aperture:
110 mm

Socket type: BA20d
Socket type 2: BA20d
Socket type 3: BA9s
Shape: Round
Asymmetric light: w/o

171007 Light Unit Std pkg 1 Servicing: HC-CARGO 171006, 170926

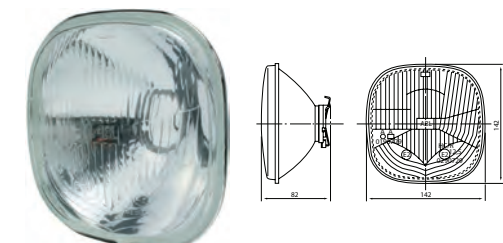

Bulb incl.: No
Watt: 60/55
Watt 2: 75/70

Dim.: 142x142x82 mm
Light aperture:
142 mm

Bulb type: H4
Bulb type 2: H4
Socket type: P43t
Socket type 2: P43t
Material: Glass
Shape: Square
Asymmetric light: w/
E-approval: Yes

171008 Lens

Std pkg 1 Servicing: HC-CARGO 171006, 170926



Colour: Orange

171937 Bulb Gasket

Std pkg 1 Servicing: HC-CARGO 170865

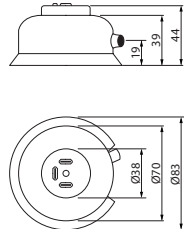

OD: 83 mm

Material: Rubber

HEADLIGHT INSERTS

170690 Light Unit

Std pkg 1 Servicing: Chrysler, Fendt, Ford, GM, IH/Case, Isuzu, John Deere, Mazda - Visit our web catalogue for further information

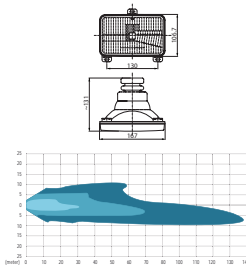

Bulb incl.: No
Watt: 60/55
Watt 2: 75/70

Dim.: 167x106.7 mm
Dist. mount. holes:
130x110 mm

Bulb type: H4
Bulb type 2: H4
Socket type: P43t
Socket type 2: P43t
Material: Metal
Material/dome: Glass
Shape: Rectangular
Fixing screw: 3
Asymmetric light: w/
RH/LH: LH
E-approval: Yes

170867 Head Lamp

Std pkg 1

Heat resistant plastic reflector bonded w/ glass lens. Flush fitting head lA. Build-in depth: 69 mm.

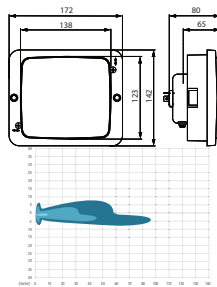

Bulb incl.: No
Watt: 60/55
Watt 2: 75/70
Watt 3: 4

Dim.: 172x142x80 mm

Bulb type: H4
Bulb type 2: H4
Socket type: P43t
Socket type 2: P43t
Socket type 3: BA9s
Material: Metal
Material/dome: Glass
Fixing screw: 2
Sidemarker: w/
RH/LH: LH
E-approval: Yes

SEALED BEAMS

4440X Sealed Beam

Std pkg 1 Servicing: Ford - Visit our web catalogue for further information

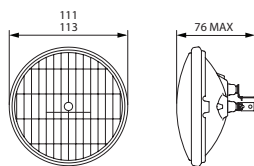

Bulb incl.: Yes
Voltage: 12
Watt: 40/40

Dim.: 113x76 mm

E-approval: No

H4360 Sealed Beam



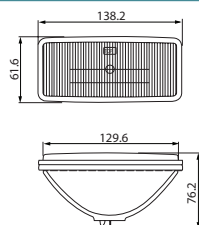





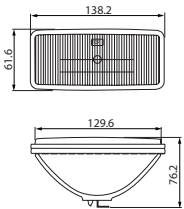

Std pkg 1 Servicing: John Deere lawn equipment w/ cooling engine - Visit our web catalogue for further information

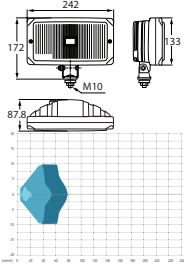

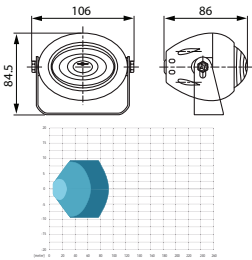
Bulb incl.: Yes
Voltage: 12
Watt: 37.5

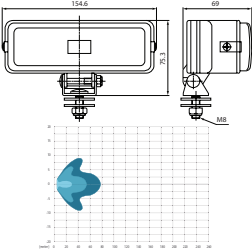
Dim.: 138.2x61.6x76.2 mm

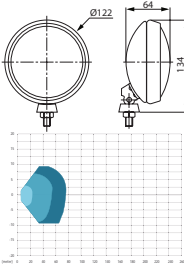
E-approval: No
Alternativ no.: h5360

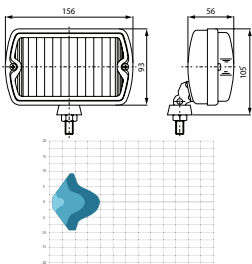
H5360 Sealed Beam		Std pkg 1	Servicing: John Deere - Visit our web catalogue for further information		
<i>Longlife.</i>					
		Bulb incl.: Yes Voltage: 12 Watt: 37.5	Dim.: 138.2x61.6x76.2 mm	E-approval: No Alternativ no.: h4360	
FOG LAMPS					
170616 Fog Lamp		Std pkg 1			
		Bulb incl.: No Watt: 55 Watt 2: 70	Dim.: 242x172x87.8 mm Light aperture: 240x170 mm	Type: Fog light Bulb type: H3 Bulb type 2: H3 Socket type: PK22s Socket type 2: PKY22s Colour: Yellow Material: Metal Material/dome: Glass Shape: Rectangular Mount.: Upright/pendant E-approval: Yes	
171360 Fog Lamp		Std pkg 2			
		Bulb incl.: No Watt: 55 Watt 2: 70	Dim.: 106x84.5x86 mm Light aperture: 55x35 mm	Type: Fog light Bulb type: H3 Bulb type 2: H3 Socket type: PK22s Socket type 2: PK22s Material: Shockproof plastic Material/dome: Glass Shape: Oval Mount.: U-bracket w/ 2 holes No./lamps: 2 E-approval: Yes	
171362 Fog Lamp		Std pkg 1			
		Bulb incl.: No Watt: 55 Watt 2: 70	Dim.: 154.6x75.3x69 mm Light aperture: 130x35 mm	Type: Fog light Bulb type: H3 Bulb type 2: H3 Socket type: PK22s Socket type 2: PK22s Material: Shockproof plastic Material/dome: Glass Shape: Rectangular Mount.: U-bracket w/ 1 bolt E-approval: No	
171364 Fog Lamp		Std pkg 1			
		Bulb incl.: No Voltage: 12/24 Watt: 55/70 Watt 2: 70	Dim.: 122x134x64 mm Light aperture: 95 mm	Type: Fog light Bulb type: H3 Bulb type 2: H3 Socket type: PK22s Socket type 2: PK22s Colour: Black Material: Metal Material/dome: Glass Shape: Round Mount.: Mounted below E-approval: No	
171366 Fog Lamp		Std pkg 1			
		Bulb incl.: No Watt: 55 Watt 2: 70	Dim.: 156x105x56 mm Light aperture: 110x75 mm	Type: Fog light Bulb type: H3 Bulb type 2: H3 Socket type: PK22s Socket type 2: PK22s Colour: Black Material: Metal Material/dome: Glass Shape: Rectangular Mount.: Mounted below E-approval: Yes	

171452 Fog Lamp Set Std pkg 1

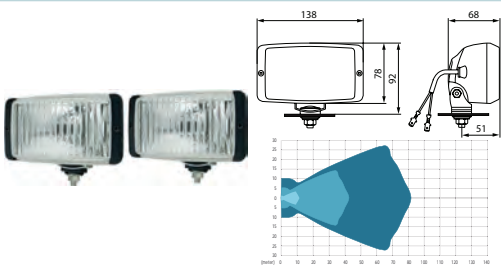

Bulb incl.: Yes
Voltage: 12
Watt: 55

Dim.: 138x78x68 mm
Light aperture:
110x60 mm

Type: Fog light
Bulb type: H3
Socket type: PK22s
Material: Shockproof plastic
Material/dome: Glass
Shape: Rectangular
Mount.: Screw
Bracket: Pendant
No./lamps: 2
E-approval: Yes

DRIVING LAMP CONVENTIONAL

171359 Driving Lamp Std pkg 2

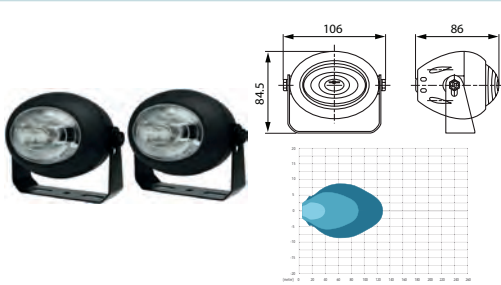

Bulb incl.: No
Watt: 55
Watt 2: 70

Dim.: 106x84.5x86 mm
Light aperture:
55x35 mm

Type: Driving lamp
Bulb type: H3
Bulb type 2: H3
Socket type: PK22s
Socket type 2: PK22s
Material: Shockproof plastic
Material/dome: Glass
Shape: Oval
Mount.: U-bracket w/ 2 holes
No./lamps: 2
Asymmetric light: w/o
E-approval: No

171361 Driving Lamp Std pkg 1

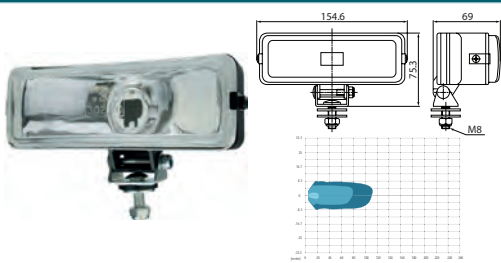

Bulb incl.: No
Watt: 55
Watt 2: 70

Dim.: 154.6x75.3x69 mm
Light aperture:
130x35 mm

Type: Driving lamp
Bulb type: H3
Bulb type 2: H3
Socket type: PK22s
Socket type 2: PK22s
Material: Shockproof plastic
Material/dome: Glass
Shape: Rectangular
Mount.: U-bracket w/ 1 bolt
E-approval: No

171363 Driving Lamp Std pkg 1

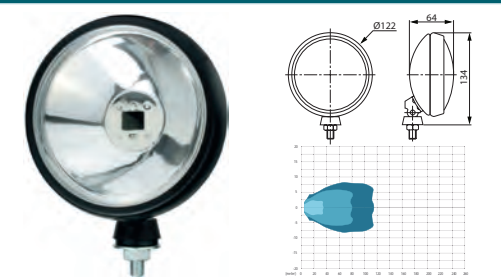

Bulb incl.: No
Voltage: 12/24
Watt: 55
Watt 2: 70

Dim.: 122x134x64 mm
Light aperture: 95 mm

Type: Driving lamp
Bulb type: H3
Bulb type 2: H3
Socket type: PK22s
Socket type 2: PK22s
Colour: Black
Material: Metal
Material/dome: Glass
Shape: Round
Mount.: Mounted below
E-approval: No

171365 Driving Lamp Std pkg 1

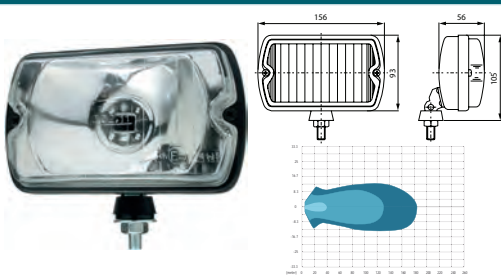

Bulb incl.: No
Watt: 55
Watt 2: 70

Dim.: 156x105x56 mm
Light aperture:
110x75 mm

Type: Driving lamp
Bulb type: H3
Bulb type 2: H3
Socket type: PK22s
Socket type 2: PK22s
Colour: Black
Material: Metal
Material/dome: Glass
Shape: Rectangular
Mount.: Mounted below
E-approval: Yes

171451 Set of Driving Lamps Std pkg 1

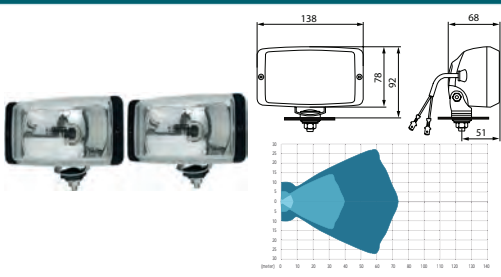

Bulb incl.: Yes
Voltage: 12
Watt: 55

Dim.: 138x78x68 mm
Light aperture:
110x60 mm

Type: Driving lamp
Bulb type: H3
Socket type: PK22s
Material: Shockproof plastic
Material/dome: Glass
Shape: Rectangular
Mount.: 1 bolt
Bracket: Pendant
No./lamps: 2
E-approval: Yes

171597 Driving Lamp

Std pkg 1

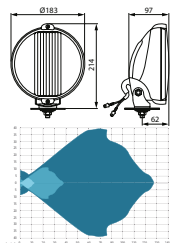

Bulb incl.: No
Watt: 55/70
Watt 2: 4

Dim.: 183x214x97 mm
Light aperture:
180 mm

Type: Driving lamp
Bulb type: H3
Socket type: PK22s
Socket type 2: BA9s
Colour: Black
Material: Metal
Material/dome: Glass
Shape: Round
Mount.: Mounted below
Sidemarker: w/
E-approval: Yes

SPARE PARTS

170621 Light Unit

Std pkg 1

Servicing: HC-CARGO 170550

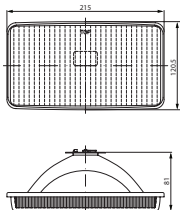

Bulb incl.: No
Watt: 55
Watt 2: 70

Dim.: 215x120.5x81 mm
Light aperture:
200x107 mm

Bulb type: H3
Bulb type 2: H3
Socket type: PK22s
Socket type 2: PK22s
Colour: Black
Material: Metal
Material/dome: Glass
Shape: Rectangular
Asymmetric light: w/o
E-approval: Yes

DRIVING LAMP LED

172059 LED Driving Lamp

Std pkg 1

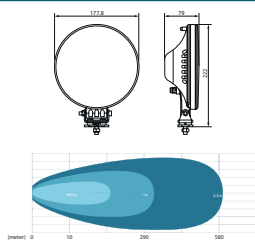

Voltage: 10-30
Watt: 60
Kelvin: 6000
Lumen: 5400

Dim.: 222x177.8x79 mm

Type: LED Driving lamp
Connection: Multiplug
Material: Cast aluminum
Material/dome: Polycarbonate
Shape: Round
Sidemarker: w/
No./LEDs: 6
RH/LH: RH/LH
Tightness norm: IP 67
Ref. no.: 25
Approval: ECE R112
E-approval: Yes

172060 LED Driving Lamp

Std pkg 1

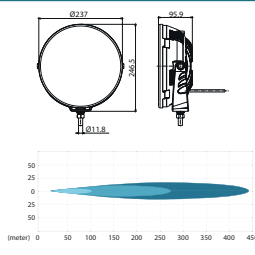

Voltage: 9-36
Watt: 18
Lumen: 4500

Dim.: 246.5x237x95.9 mm
Cable length: 300 mm

Type: LED Driving lamp
Connection: Cable
Material: Aluminium
Material/dome: Polycarbonate
Shape: Round
Sidemarker: w/
No./LEDs: 5
RH/LH: RH/LH
Tightness norm: IP 69K
Ref. no.: 30
Approval: ECE R112
E-approval: Yes

172092 LED Driving Light Bar

Std pkg 1

DT Connector: HC-CARGO 193365, 193366.

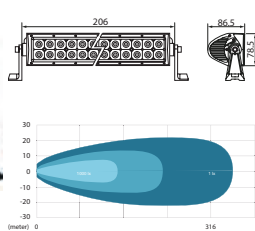

Voltage: 10-30
Amp: 2.2/1.2
Watt: 36
Kelvin: 6000
Lumen: 3240

Dim.: 206x86.5x78.5 mm
Cable length: 500 mm

Type: 12 LED
Colour: Black
Material/dome: Polycarbonate
Material/house: Cast aluminum
Reflector system: Driving
Shape: Straight
Mount. bracket: Vertical
Male/female: Male/Female
Tightness norm: IP 69K
Ref. no.: 25
Approval: ECE R112
E-approval: Yes

172093 LED Driving Light Bar

Std pkg 1

DT Connector: HC-CARGO 193365, 193366.

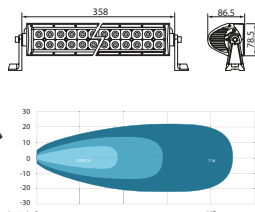

Voltage: 10-30
Amp: 4.2/2.2
Watt: 72
Kelvin: 6000
Lumen: 6480

Dim.: 358x86.5x78.5 mm
Cable length: 500 mm

Type: 24 LED
Colour: Black
Material/dome: Polycarbonate
Material/house: Cast aluminum
Reflector system: Driving
Shape: Straight
Mount. bracket: Vertical
Male/female: Male/Female
Tightness norm: IP 69K
Ref. no.: 40
Approval: ECE R112
E-approval: Yes

172102 LED Driving Light Bar Std pkg 1

DT Connector: HC-CARGO 193365, 193366.

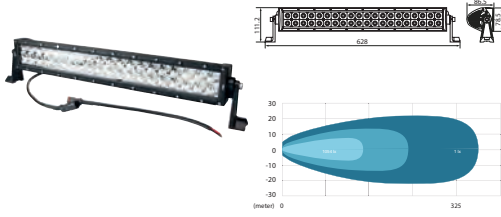

Voltage: 10-30
Amp: 6.6/3.4
Watt: 120
Kelvin: 6000
Lumen: 10800

Dim.: 628x111.2x86.5 mm
Cable length: 500 mm

Type: 40 LED
Colour: Black
Material/dome: Polycarbonate
Material/house: Cast aluminum
Reflector system: Driving
Shape: Straight
Mount. bracket: Vertical
Male/female: Male/Female
Tightness norm: IP 69K
Ref. no.: 40
Approval: ECE R112
E-approval: Yes

172144 LED Driving Lamp Std pkg 1

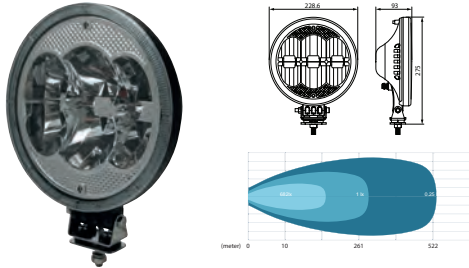

Voltage: 10-30
Watt: 60
Kelvin: 6000
Lumen: 5400

Dim.: 275x228.6x93 mm

Type: LED Driving lamp
Connection: Multiplug
Material: Cast aluminum
Material/dome: Polycarbonate
Shape: Round
No./LEDs: 6
RH/LH: RH/LH
Tightness norm: IP 67
Ref. no.: 25
Approval: ECE R112
E-approval: Yes

172212 LED Driving Lamp Std pkg 1

5".

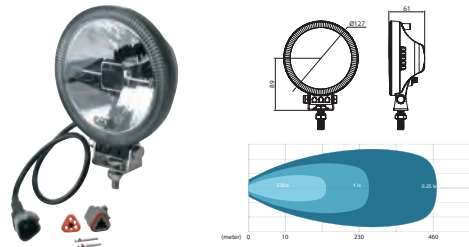

Voltage: 10-30
Watt: 20
Lumen: 1800

Dim.: 127x89x61 mm

Type: LED Driving lamp
Material: Stainless steel
Material/dome: Polycarbonate
Shape: Round
Tightness norm: IP 67/IP 69K
Ref. no.: 12.5
Approval: ECE R112
E-approval: Yes

POSITION LAMPS CONVENTIONAL

170875 Position Lamp Std pkg 1

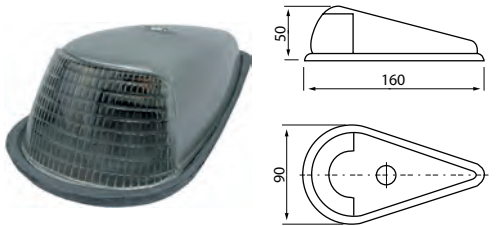

Bulb incl.: No
Voltage: 12/24
Watt: 5

Dim.: 160x59x45 mm
Dist. mount. holes: 57 mm

Bulb type: BA15s
Connection: Screw
Colour/glass: White
Material: Plastic
Fixing screw: 2

170881 Position Lamp Std pkg 1

Lens: HC-CARGO 170976.

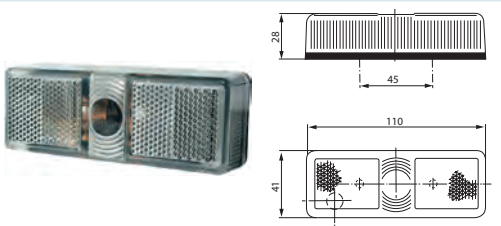

Bulb incl.: No
Watt: 5

Dim.: 110x41x28 mm
Dist. mount. holes: 45 mm

Socket type: S8.5
Connection: Terminal
Colour/glass: White
Material: Shockproof plastic
Shape: Rectangular
Reflector: w/
Fixing screw: 2
Sidemarker lamp: w/
Tail light: w/
E-approval: Yes

170887 Position Lamp Std pkg 1



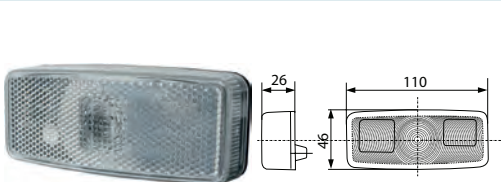





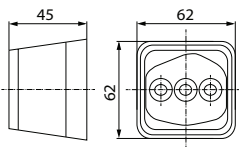

Lens: HC-CARGO 170952.

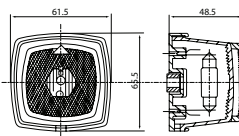

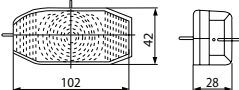
Bulb incl.: No
Watt: 5

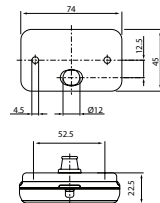
Dim.: 110x46x26 mm
Dist. mount. holes: 85 mm

Socket type: T10
Connection: Terminal
Colour/glass: White
Material: Shockproof plastic
Shape: Rectangular
Reflector: w/
Fixing screw: 2
Sidemarker lamp: w/
Tail light: w/
E-approval: Yes

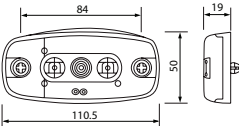
		EL. SPECIFICATIONS	DIMENSIONS	ADDITIONAL SPECIFICATIONS
171171	Position Lamp	Std pkg 1		
		Bulb incl.: No Watt: 5	Dim.: 62x62x45 mm Dist. mount. holes: 30 mm	Socket type: S8.5 Connection: Terminal Colour: Black Colour/glass: Transparent Material: Shockproof plastic Fixing screw: 2 E-approval: Yes
171174	Position Lamp	Std pkg 1		
Lens: HC-CARGO 171242.				
		Bulb incl.: No Watt: 5	Dim.: 62x62x46 mm Dist. mount. holes: 30 mm	Socket type: S8.5 Connection: Terminal Colour: Black Colour/glass: White Material: Shockproof plastic Shape: Square Reflector: w/ Fixing screw: 2 E-approval: Yes
171332	Position Lamp	Std pkg 1		
		Bulb incl.: No Watt: 5	Dim.: 102x42x28 mm Dist. mount. holes: 65 mm	Socket type: S8.5 Connection: Terminal Colour: Black Colour/glass: White Material: Plastic Fixing screw: 2 E-approval: Yes
171493	Position Lamp	Std pkg 1		
		Bulb incl.: No Watt: 5	Dim.: 74x45x22.5 mm Dist. mount. holes: 52 mm	Socket type: S8.5 Connection: Terminal Colour: Black Colour/glass: White Material: Plastic Shape: Rectangular Reflector: w/ Fixing screw: 2 E-approval: Yes
SPARE PARTS				
170952	Lens	Std pkg 1	Servicing: HC-CARGO 170887	
			Dim.: 110x46x26 mm	Shape: Rectangular
170976	Lens	Std pkg 1	Servicing: HC-CARGO 170881	
			Dim.: 110x41x28 mm	Shape: Rectangular
POSITION LAMPS LED				
171638	LED Position Lamp	Std pkg 1		
Angle Bracket: HC-CARGO 171639.				
		Voltage: 9-36 Watt: 0.9	Dim.: 110.5x50x19 mm Dist. mount. holes: 83 mm	Type: LED Position lamp Colour/glass: White Reflector: w/ Sidemarker: w/ No./LEDs: 3 Approval: ADR E-approval: Yes

171717 LED Position Lamp Std pkg 1

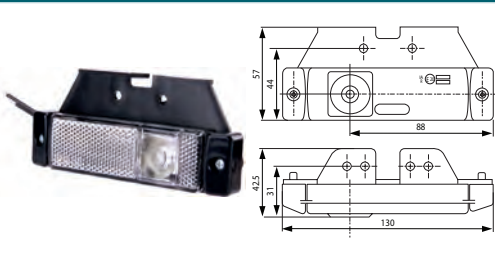

Voltage: 12/24
Watt: 0.4/0.8

Dim.: 130x57x42.5 mm

Type: LED Position lamp
Socket type: LED
Connection: Cable
Colour/glass: White
Material: Shockproof plastic
Bracket: Angled
Reflector: w/
Sidemarker: w/
No./LEDs: 1
E-approval: Yes

171718 LED Position Lamp Std pkg 1



Voltage: 12/24
Watt: 0.4/0.8

Dim.: 130x32x20.5 mm

Type: LED Position lamp
Socket type: LED
Connection: Cable
Colour/glass: White
Material: Shockproof plastic
Reflector: w/
Sidemarker: w/
No./LEDs: 1
E-approval: Yes

171744 LED Position Lamp Std pkg 1

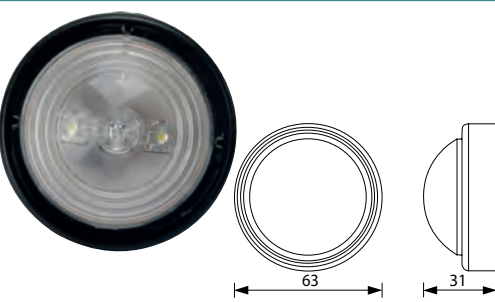

Voltage: 9-36

Dim.: 63x31 mm
OD: 63 mm
Cable length: 300 mm
Dist. mount. holes:
30 mm

Type: LED Position lamp
Connection: Cable
Colour: Black
Colour/glass: Transparent
Material: PVC
Material/dome: PMMA
Shape: Round
Mount.: 2 screws
Sidemarker: w/
No./LEDs: 3
Approval: SAE/ECE
E-approval: Yes

171841 LED Position Lamp Std pkg 1

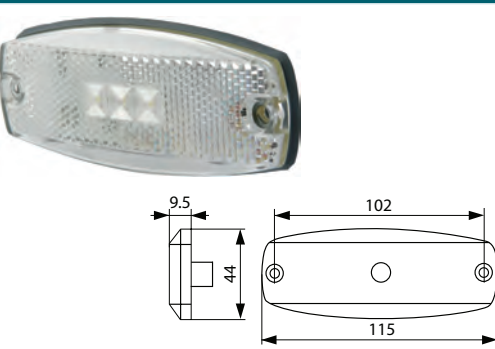

Voltage: 12/24
Watt: 0.45-1.6

Dim.: 115x44x9.5 mm
Cable length: 5000 mm
Dist. mount. holes:
102 mm

Type: LED Position lamp
Connection: Cable
Colour: White
Colour/glass: White
Material: Polycarbonate
Material/dome: Polycarbonate
Shape: Rectangular
Mount.: 2 screws
Reflector: w/
Sidemarker: w/
No./LEDs: 3
Tightness norm: IP 67
Approval: SAE
E-approval: Yes

171844 LED Position Lamp Std pkg 1

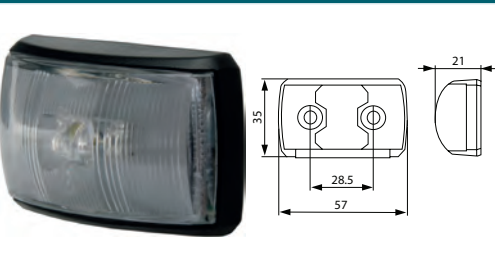

Voltage: 12/24

Dim.: 57x35x21 mm
Cable length: 400 mm
Dist. mount. holes:
28 mm

Type: LED Position lamp
Connection: Cable
Colour: Black
Colour/glass: White
Shape: Rectangular
Fixing screw: 2
Sidemarker: w/
No./LEDs: 2
Tightness norm: IP 67
E-approval: Yes









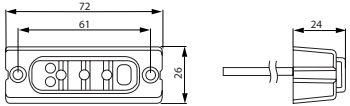

171862 LED Position Lamp Std pkg 1

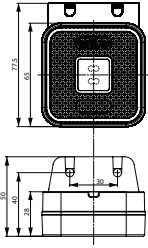

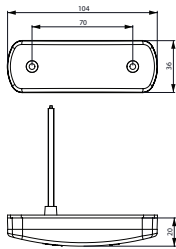
Voltage: 12/24
Watt: 0.3-0.6

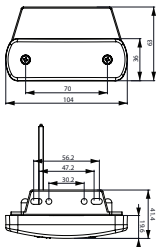
Dim.: 72x26x24 mm
Cable length: 5000 mm
Dist. mount. holes:
61 mm

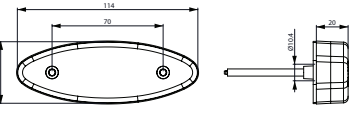
Type: LED Position lamp
Colour: Black
Colour/glass: White
Material: PP
Material/dome: PMMA
Shape: Rectangular
Sidemarker: w/
No./LEDs: 3
Approval: CE
E-approval: Yes

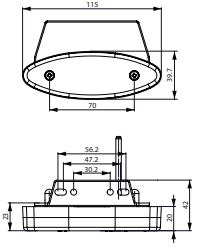
		EL. SPECIFICATIONS	DIMENSIONS	ADDITIONAL SPECIFICATIONS
171868	LED Position Lamp	Std pkg 1		
		Voltage: 12/24 Watt: 0.3-0.6	Dim.: 72x26x24 mm Cable length: 5000 mm Dist. mount. holes: 61 mm	Type: LED Position lamp Colour: Black Colour/glass: White Material: PP Material/dome: PMMA Shape: Rectangular Bracket: Adjustable Sidemarker lamp: w/ No./LEDs: 3 Approval: CE E-approval: Yes
171956	LED Position Lamp	Std pkg 1		
		Voltage: 12-24 Watt: 1	Dim.: 65x65x28 mm Cable length: 220 mm Dist. mount. holes: 30 mm	Type: LED Side marker lamp Connection: Cable Colour/glass: White Material: ABS plastic Material/dome: PMMA Shape: Square Bracket: Angled Reflector: w/ Sidemarker lamp: w/ No./LEDs: 2 Tightness norm: IP 68 E-approval: Yes
172038	LED Position Lamp	Std pkg 1		
		Voltage: 12/24 Watt: 0.49	Dim.: 104x36x20 mm Cable length: 500 mm Dist. mount. holes: 70 mm	Type: LED Position lamp Colour/glass: White Material: Shockproof plastic Shape: Rectangular Reflector: w/ Fixing screw: 2 Sidemarker: w/ No./LEDs: 1 E-approval: Yes
172039	LED Position Lamp	Std pkg 1		
		Voltage: 12/24 Watt: 0.49	Dim.: 104x36x19.6 mm Cable length: 500 mm Dist. mount. holes: 52 mm	Type: LED Position lamp Connection: Cable Colour/glass: White Material: Shockproof plastic Bracket: Angled Reflector: w/ Fixing screw: 2 Sidemarker: w/ No./LEDs: 1 E-approval: Yes
172043	LED Position Lamp	Std pkg 1		
		Voltage: 12/24 Watt: 0.44	Dim.: 114x39x20 mm Cable length: 500 mm Dist. mount. holes: 70 mm	Type: LED Position lamp Connection: Cable Colour/glass: White Material: Shockproof plastic Reflector: w/ Fixing screw: 2 Sidemarker: w/ No./LEDs: 1 E-approval: Yes
172044	LED Position Lamp	Std pkg 1		
		Voltage: 12/24 Watt: 0.44	Dim.: 115x39.7x20 mm Cable length: 500 mm Dist. mount. holes: 52 mm	Type: LED Position lamp Connection: Cable Colour/glass: White Material: Shockproof plastic Shape: Oval Bracket: Angled Reflector: w/ Fixing screw: 2 Sidemarker: w/ No./LEDs: 1 E-approval: Yes

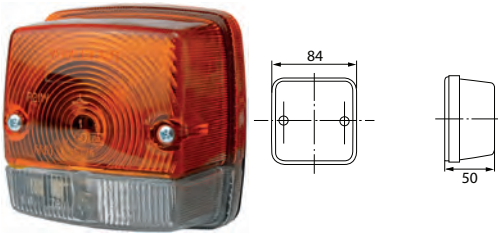
FLASHER-POSITION LAMPS CONVENTIONAL
170925 Flasher/Position Lamp Std pkg 1

 Bulb incl.: No
 Watt: 21
 Watt 2: 5

 Dim.: 84x50 mm
 Dist. mount. holes:
 45 mm

 Socket type: BA15S
 Socket type 2: S8.5
 Connection: Terminal
 Material: Shockproof plastic
 Shape: Square
 Fixing screw: 2
 RH/LH: RH/LH
 E-approval: Yes

170927 Flasher/Position Lamp Std pkg 1

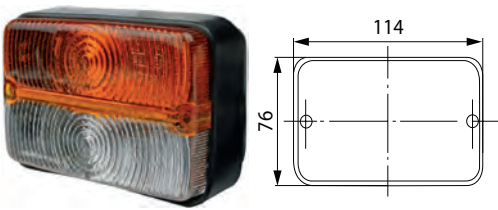
Lens: HC-CARGO 170989.



 Bulb incl.: No
 Watt: 21
 Watt 2: 5

 Dim.: 114x76 mm
 Dist. mount. holes:
 58 mm

 Socket type: BA15S
 Socket type 2: BA15S
 Connection: Terminal
 Material: Shockproof plastic
 Shape: Rectangular
 Fixing screw: 2
 RH/LH: RH/LH
 E-approval: Yes

170941 Flasher/Position Lamp Std pkg 1 Servicing: HC-CARGO 170828

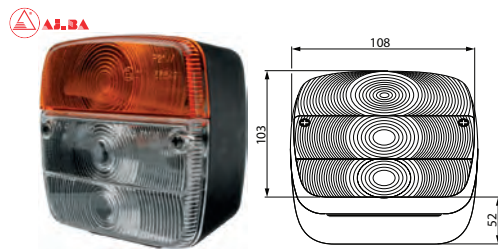
Lens: HC-CARGO 170834.

 Bulb incl.: No
 Watt: 21
 Watt 2: 5

 Dim.: 108x103x52 mm
 Dist. mount. holes:
 55 mm

 Socket type: BA15S
 Socket type 2: S8.5
 Connection: Terminal
 Material: Shockproof plastic
 Shape: Square
 Fixing screw: 2
 Flasher light: w/
 Sidemarker: w/
 RH/LH: RH/LH
 E-approval: Yes

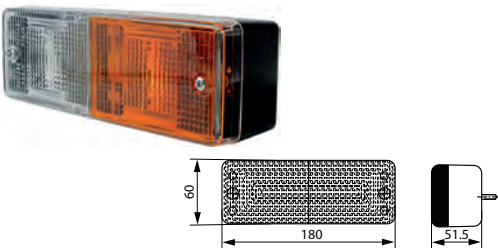
171510 Flasher/Position Lamp Std pkg 1

 Bulb incl.: No
 Watt: 21
 Watt 2: 5

 Dim.: 180x60x51.5 mm
 Dist. mount. holes:
 134 mm

 Socket type: BA15S
 Socket type 2: BA15S
 Connection: Terminal
 Material: Shockproof plastic
 Shape: Rectangular
 Fixing screw: 2
 RH/LH: RH/LH
 E-approval: Yes

SPARE PARTS
170834 Lens, Rear Lamp Std pkg 1 Servicing: HC-CARGO 170941

Dim.: 108x103x52 mm

 Shape: Square
 Fixing screw: 2
 Flasher light: w/
 Sidemarker: w/

170989 Lens Std pkg 1 Servicing: HC-CARGO 170927



Dim.: 114x76 mm

Shape: Rectangular

FLASHER-POSITION LAMPS LED

171800 LED Flasher/Positions Lamp Std pkg 1

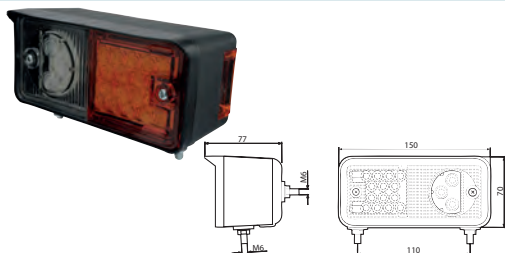
Right: HC-CARGO 171801.



Voltage: 12/24

 Dim.: 150x70x77 mm
 Cable length: 2100 mm
 Dist. mount. holes:
 110/55 mm

 Connection: Terminal
 Colour: Black
 Material: Shockproof plastic
 Shape: Rectangular
 Mount.: Upright/pendant
 Fixing screw: 2
 No./LEDs: 14/3
 RH/LH: LH
 E-approval: Yes

171801 LED Flasher/Positions Lamp Std pkg 1

Left: HC-CARGO 171800.

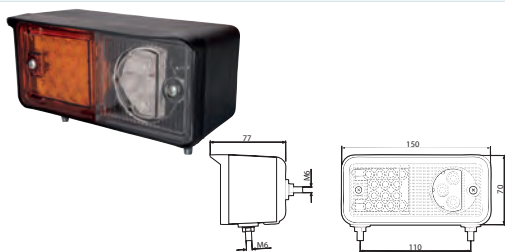

Voltage: 12/24

 Dim.: 150x70x77 mm
 Cable length: 2100 mm
 Dist. mount. holes:
 110/55 mm

 Connection: Terminal
 Colour: Black
 Material: Shockproof plastic
 Shape: Rectangular
 Mount.: Upright/pendant
 Fixing screw: 2
 No./LEDs: 14/3
 RH/LH: RH
 E-approval: Yes

SIDE INDICATORS CONVENTIONAL

170713 Side Indicator Std pkg 1

Lens: HC-CARGO 170670, 170671.

 Bulb incl.: No
 Watt: 5

 Dim.: 108x84x93 mm
 OD: 60 mm

 Socket type: BA15S
 Colour/glass: Orange
 E-approval: Yes

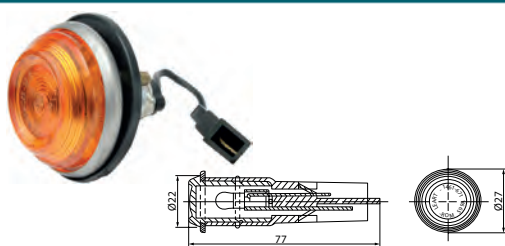
171140 Side Indicator Std pkg 1 Servicing: Fiat, Ford, Lada, Universal - Visit our web catalogue for further information

 Bulb incl.: No
 Watt: 3

 OD: 27 mm
 Dist. mount. holes:
 28 mm

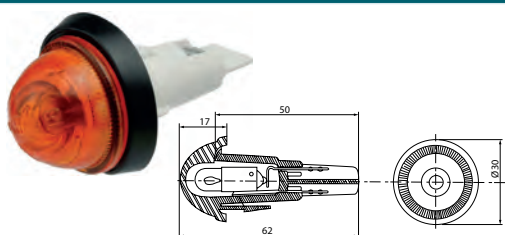
 Socket type: BA9s
 Connection: Multiplug
 Colour/glass: Orange
 E-approval: Yes

171141 Side Indicator Std pkg 1 Servicing: Fiat 127, 129 - Visit our web catalogue for further information

Bulb incl.: No

Dim.: 62x50x17 mm



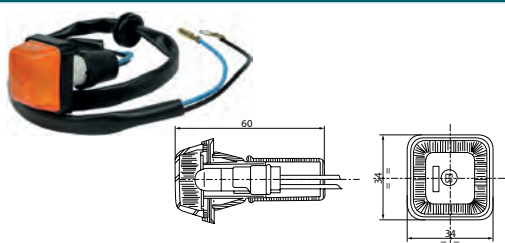



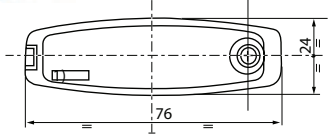

 Colour/glass: Orange
 E-approval: Yes

171147 Side Indicator Std pkg 1 Servicing: Ford, Universal - Visit our web catalogue for further information

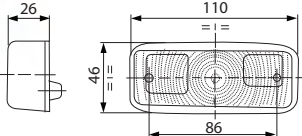
Bulb incl.: No

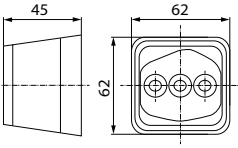
Dim.: 34x34x60 mm

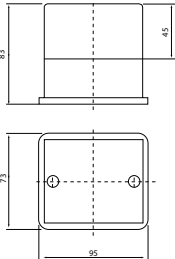
 Colour/glass: Orange
 E-approval: Yes

		EL. SPECIFICATIONS	DIMENSIONS	ADDITIONAL SPECIFICATIONS
171148 Side Indicator		Std pkg 1	Servicing: Universal, Ford, Rover Group - Visit our web catalogue for further information	
 		Bulb incl.: No	Dim.: 76x24 mm	Socket type: BA9s Colour/glass: Orange E-approval: Yes
171153 Side Indicator		Std pkg 1	Servicing: Audi, VW - Visit our web catalogue for further information	
 		Bulb incl.: No Voltage: 12 Watt: 5	Dim.: 110x46x26 mm Dist. mount. holes: 86 mm	Type: Flasher lamp Connection: Terminal Colour/glass: Orange Material: Plastic Material/dome: Plastic Shape: Flat Mount.: Sidemounted No./lamps: 1 Flasher light: w/ RH/LH: RH/LH E-approval: Yes
171175 Side Marker Lamp		Std pkg 1	Servicing: Audi, VW - Visit our web catalogue for further information	
 		Bulb incl.: No Watt: 5	Dim.: 62x62x45 mm Dist. mount. holes: 30 mm	Socket type: S8.5 Connection: Terminal Colour: Black Colour/glass: Orange Material: Shockproof plastic Reflector: w/ Fixing screw: 2 E-approval: Yes
171337 Side Indicator		Std pkg 1	Servicing: Audi, VW - Visit our web catalogue for further information	
 		Bulb incl.: No Watt: 10	Dim.: 95x73x83 mm Dist. mount. holes: 48 mm	Socket type: BA15S Connection: Terminal Colour: Black Colour/glass: Orange Material: Plastic Fixing screw: 2 E-approval: Yes
SPARE PARTS				
170670 Lens		Std pkg 1	Servicing: HC-CARGO 170713	
				Colour/glass: Orange Material: Glass
170671 Bulb Holder		Std pkg 1	Servicing: HC-CARGO 170640, 170668, 170713	
				

SIDE INDICATORS LED

171770 LED Flasher Lamp

Std pkg 1

Servicing: Fiat, Kia, MAN - Visit our web catalogue for further information

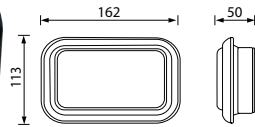
 Voltage: 24
Watt: 4

Dim.: 162x113x50 mm

 Type: LED Flasher lamp
 Connection: Multiplug
 Colour/glass: Orange
 Material: ABS plastic
 Material/dome: PMMA
 Shape: Rectangular
 Mount.: Plan installation
 Flasher light: w/
 No./LEDs: 16
 RH/LH: RH/LH
 E-approval: Yes

SIDE MARKER LAMPS CONVENTIONAL

170880 Side Marker Lamp

Std pkg 1

Lens: HC-CARGO 170975.

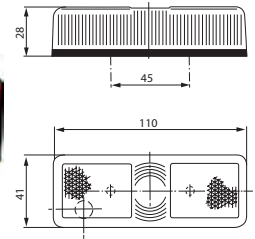
 Bulb incl.: No
Watt: 5

 Dim.: 110x41x28 mm
 Dist. mount. holes:
45 mm

 Socket type: S8.5
 Connection: Terminal
 Colour: Black
 Colour/glass: Orange
 Material: Shockproof plastic
 Shape: Rectangular
Reflector: w/
 Fixing screw: 2
 E-approval: Yes
 Alternativ no.: 172226

170884 Side Marker Lamp

Std pkg 1

Lens: HC-CARGO 170946.

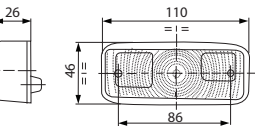
 Bulb incl.: No
Watt: 5

 Dim.: 110x46x26 mm
 Dist. mount. holes:
85 mm

 Socket type: T10
 Connection: Terminal
 Colour/glass: Orange
 Material: Shockproof plastic
 Shape: Rectangular
Reflector: w/
 Fixing screw: 2
 E-approval: Yes

170885 Side Marker Lamp

Std pkg 1

Lens: HC-CARGO 170946.

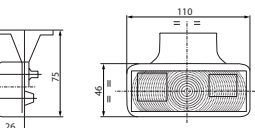

 Bulb incl.: No
Watt: 5

 Dim.: 110x46x26 mm
 Dist. mount. holes:
20/50 mm

 Socket type: T10
 Connection: Terminal
 Colour/glass: Orange
 Material: Shockproof plastic
 Shape: Rectangular
 Bracket: Angled
Reflector: w/
 E-approval: Yes

171343 Side Marker Lamp

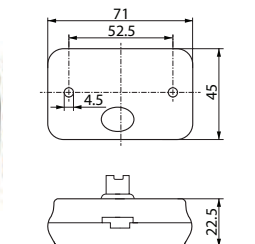
Std pkg 1



 Bulb incl.: No
Watt: 5

 Dim.: 74x45x22.5 mm
 Dist. mount. holes:
52 mm

 Socket type: S8.5
 Connection: Terminal
 Colour: Black
 Colour/glass: Orange
 Material: Plastic
 Shape: Rectangular
 Fixing screw: 2
 E-approval: Yes

171369 Side Marker Lamp

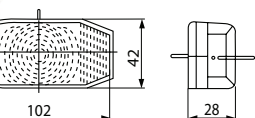
Std pkg 1



 Bulb incl.: No
Watt: 5

 Dim.: 102x42x28 mm
 Dist. mount. holes:
65 mm

 Socket type: S8.5
 Connection: Terminal
 Colour: Black
 Colour/glass: Orange
 Material: Plastic
 Fixing screw: 2
 E-approval: Yes

172226 Side Marker Lamp Std pkg 1

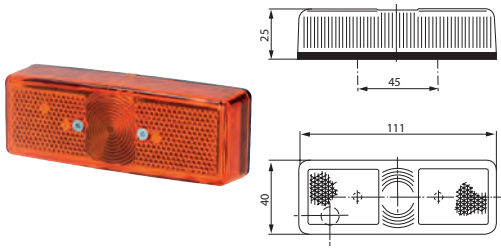
Lens: HC-CARGO 172227.



Bulb incl.: No
Voltage: 12
Watt: 5

Dim.: 111x40x25 mm
Dist. mount. holes:
45 mm

Socket type: S8.5
Colour: Black
Colour/glass: Orange
Material: Polycarbonate
Material/dome: PMMA
Shape: Rectangular
Reflector: w/
Fixing screw: 2

SPARE PARTS

170946 Lens Std pkg 1 Servicing: HC-CARGO 170884, 170885



Dim.: 110x46 mm

170975 Lens Std pkg 1 Servicing: HC-CARGO 170880



Dim.: 110x41x28 mm

Alternativ no.: 172227

172227 Lens Std pkg 1 Servicing: HC-CARGO 172226



Dim.: 111x40x25 mm

SIDE MARKER LAMPS LED

171618 LED Side Marker Lamp Std pkg 1

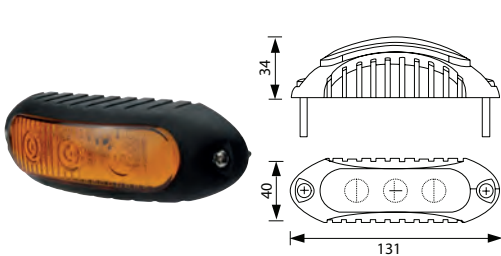

Voltage: 9-36

Dim.: 131x40x34 mm
Cable length: 28 mm
Dist. mount. holes:
115 mm

Type: LED Side marker lamp
Connection: Cable
Colour/glass: Orange
Material: PP/PMMA
Material/dome: ABS plastic
Mount.: Screw fastening
No./lamps: 1
Fixing screw: 2
Sidemarker lamp: w/
No./LEDs: 3
Wiring system: w/
E-approval: Yes

171636 LED Side Marker Lamp Std pkg 1

Angle Bracket: HC-CARGO 171639.

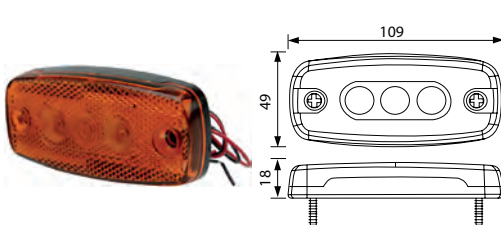

Voltage: 9-36
Watt: 0.9

Dim.: 109x49x18 mm
Dist. mount. holes:
83 mm

Type: LED Side marker lamp
Connection: Cable
Colour/glass: Orange
Shape: Rectangular
Reflector: w/
Sidemarker lamp: w/
No./LEDs: 3
E-approval: Yes

EL. SPECIFICATIONS		DIMENSIONS	ADDITIONAL SPECIFICATIONS
171721 LED Side Marker Lamp Std pkg 1 		Voltage: 12/24 Dim.: 130x57x42.5 mm Cable length: 210 mm Dist. mount. holes: 50 mm	Type: LED Side marker lamp Connection: Cable Material: Shockproof plastic Shape: Rectangular Bracket: Angled Reflector: w/ Sidemarkers lamp: w/ No./LEDs: 1 E-approval: Yes
171722 LED Side Marker Lamp Std pkg 1 		Voltage: 12/24 Dim.: 130x32x20.5 mm Dist. mount. holes: 116 mm	Type: LED Side marker lamp Connection: Cable Colour/glass: Orange Material: Shockproof plastic Shape: Rectangular Mount.: Flat w/ 2 fixing holes Reflector: w/ Fixing screw: 2 Sidemarkers lamp: w/ No./LEDs: 1 E-approval: Yes
171729 LED Side Marker Lamp Std pkg 1 		Voltage: 12/24 Watt: 1 Dim.: 65x65x28 mm Dist. mount. holes: 30 mm	Service: MAN - Visit our web catalogue for further information Type: LED Side marker lamp Connection: Cable Colour/glass: Orange Material: ABS plastic Material/dome: PMMA Shape: Square Bracket: Angled Reflector: w/ Sidemarkers lamp: w/ No./LEDs: 2 E-approval: Yes
171735 LED Side Marker Lamp Std pkg 1 		Voltage: 12 Dim.: 110x41x19.6 mm Cable length: 200 mm Dist. mount. holes: 75 mm	Type: LED Side marker lamp Connection: Cable Shape: Rectangular Sidemarkers lamp: w/ No./LEDs: 1 E-approval: Yes
171736 LED Side Marker Lamp Std pkg 1 		Voltage: 24 Dim.: 110x41x19.6 mm Cable length: 20 mm Dist. mount. holes: 75 mm	Type: LED Side marker lamp Shape: Rectangular Sidemarkers lamp: w/ No./LEDs: 1 E-approval: Yes
171742 LED Side Marker Lamp Std pkg 1 		Voltage: 12/24 Dim.: 63x31 mm OD: 63 mm Cable length: 300 mm	Type: LED Side marker lamp Connection: Cable Colour: Black Colour/glass: Orange Material: PVC Material/dome: PMMA Mount.: 2 screws Sidemarkers lamp: w/ No./LEDs: 3 Approval: SAE/ECE E-approval: Yes

171835 LED Adapter Std pkg 1 Servicing: HC-CARGO 171836, 193119

HC-CARGO 171835 is the LED version of HC-CARGO 170763.

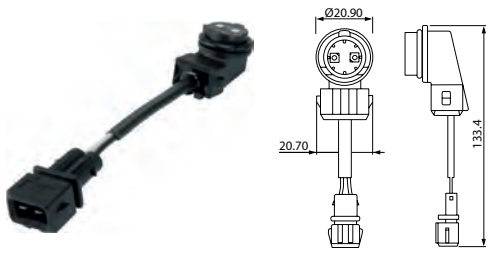

Voltage: 12-24

Cable length: 66 mm

Type: LED
 Connection: Multiplug
 LEDs: w/
 Tightness norm: IP 69K
 E-approval: Yes

171836 Lens Std pkg 1

LED Adapter: HC-CARGO 171835.

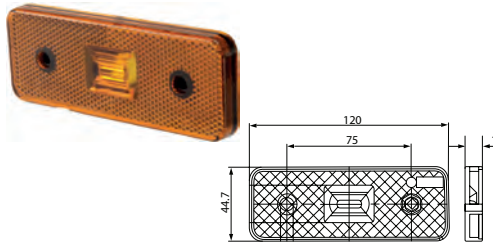

Dim.: 120x44.7x10 mm

Shape: Square
 E-approval: Yes

171839 LED Side Marker Lamp Std pkg 1

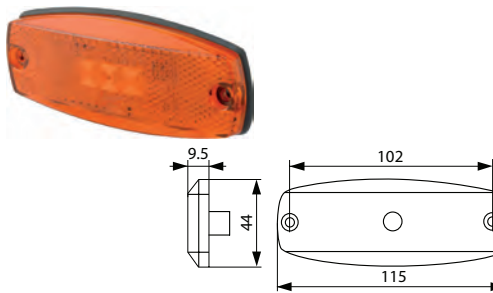

Voltage: 12/24
 Watt: 0.45-1.6

Dim.: 115x44x9.5 mm
 Cable length: 5000 mm
 Dist. mount. holes: 102 mm

Type: LED Side marker lamp
 Connection: Cable
 Colour: White
 Colour/glass: Orange
 Material: Polycarbonate
 Material/dome: Polycarbonate
 Shape: Rectangular
 Mount.: 2 screws
 Reflector: w/
 Sidemarker lamp: w/
 No./LEDs: 3
 Tightness norm: IP 67
 Approval: SAE
 E-approval: Yes

171842 LED Side Marker Lamp Std pkg 1

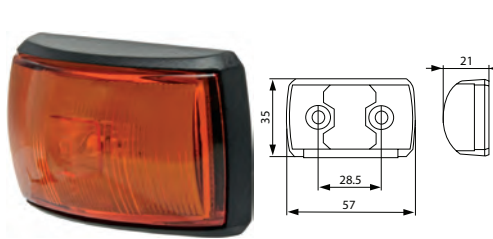

Voltage: 12/24

Dim.: 57x35x21 mm
 Cable length: 400 mm
 Dist. mount. holes: 28.5 mm

Type: LED Side marker lamp
 Connection: Cable
 Colour: Black
 Colour/glass: Orange
 Material: ASA plastic
 Material/dome: PMMA
 Shape: Rectangular
 Fixing screw: 2
 Sidemarker lamp: w/
 No./LEDs: 2
 Tightness norm: IP 67
 E-approval: Yes

171860 LED Side Marker Lamp Std pkg 1



Voltage: 12/24
 Watt: 0.3-0.6

Dim.: 72x26x24 mm
 Cable length: 5000 mm
 Dist. mount. holes: 61 mm

Type: LED Side marker lamp
 Colour: Black
 Colour/glass: Orange
 Material: PP
 Material/dome: PMMA
 Shape: Rectangular
 Fixing screw: 2
 Sidemarker: w/
 No./LEDs: 3
 Approval: CE
 E-approval: Yes

172036 LED Side Marker Lamp Std pkg 1

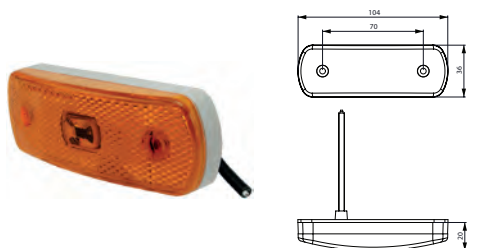

Voltage: 12/24

Dim.: 104x36x20 mm
 Cable length: 500 mm
 Dist. mount. holes: 70 mm

Type: LED Side marker lamp
 Connection: Cable
 Colour/glass: Orange
 Material: Shockproof plastic
 Shape: Rectangular
 Reflector: w/
 Fixing screw: 2
 Sidemarker lamp: w/
 No./LEDs: 1
 E-approval: Yes

172037 LED Side Marker Lamp Std pkg 1

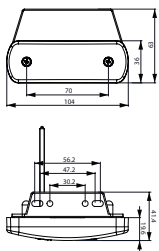

Voltage: 12/24

Dim.: 104x36x19.6 mm
Cable length: 500 mm
Dist. mount. holes: 70 mm

Type: LED Side marker lamp
Connection: Cable
Colour/glass: Orange
Material: Shockproof plastic
Shape: Rectangular
Bracket: Angled
Reflector: w/
Fixing screw: 2
Sidemarker lamp: w/
No./LEDs: 1
E-approval: Yes

172041 LED Side Marker Lamp Std pkg 1

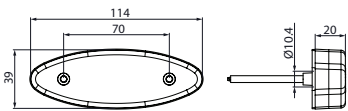

Voltage: 12/24

Dim.: 114x39x20 mm
Cable length: 500 mm
Dist. mount. holes: 70 mm

Type: LED Side marker lamp
Colour/glass: Orange
Material: Shockproof plastic
Reflector: w/
Fixing screw: 2
Sidemarker lamp: w/
No./LEDs: 1
E-approval: Yes

172042 LED Side Marker Lamp Std pkg 1

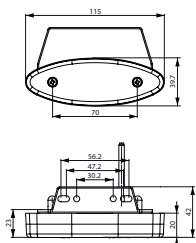

Voltage: 12/24

Dim.: 115x39.7x20 mm
Dist. mount. holes: 70 mm

Type: LED Side marker lamp
Colour/glass: Orange
Material: Shockproof plastic
Shape: Oval
Bracket: Angled
Reflector: w/
Fixing screw: 2
Sidemarker lamp: w/
No./LEDs: 1
E-approval: Yes

ACCESSORIES

171639 Angle Bracket Std pkg 1 Servicing: HC-CARGO 171636, 171637, 171638



193119 Junior Power Timer Connector Std pkg 10

Terminal: HC-CARGO 191551, 192155, 192175, 192176. Wire seal: HC-CARGO 192177, 192178. LED Adapter: HC-CARGO 171835.

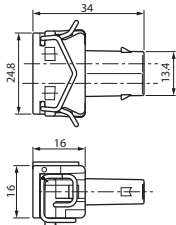

Type/terminal: Junior Power Timer
Colour: Black
No./poles: 2
Plug: Female

TAIL LIGHTS

REVERSING LAMPS CONVENTIONAL



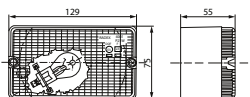

170689 Reversing Lamp Std pkg 1

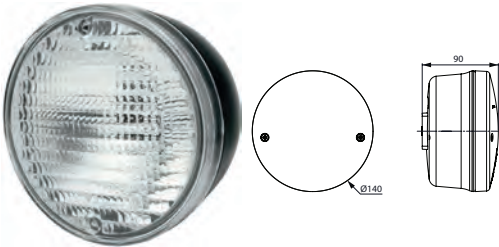
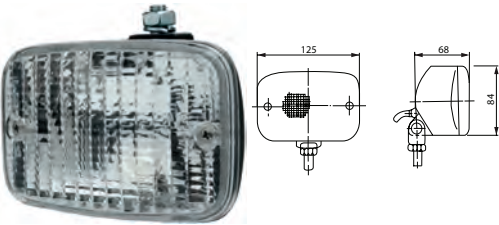
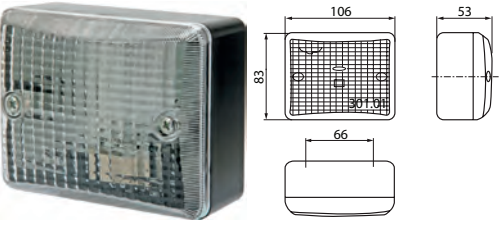

Bulb incl.: No
Watt: 21

Dim.: 129x75x55 mm
Dist. mount. holes: 56 mm

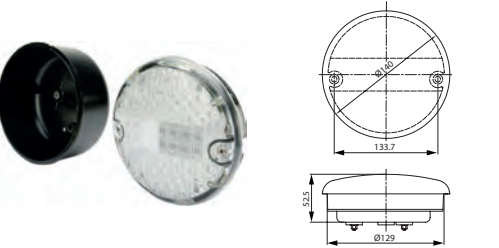
Socket type: BA15S
Connection: Terminal
Shape: Rectangular
Bracket: Straight
Fixing screw: 1
Reverse light: w/
E-approval: Yes

		EL. SPECIFICATIONS	DIMENSIONS	ADDITIONAL SPECIFICATIONS
170934 Reversing Lamp Std pkg 1			Bulb incl.: No Watt: 21 Dim.: 140x90 mm Dist. mount. holes: 45 mm	Socket type: BA15S Connection: Terminal Colour: Black Material: Shockproof plastic Shape: Round Fixing screw: 2 Reverse light: w/ Wiring system: w/ E-approval: Yes
170935 Reversing Lamp Std pkg 1			Bulb incl.: No Watt: 21 Dim.: 125x84x68 mm	Socket type: BA15S Connection: Terminal Colour: Black Material: Shockproof plastic Shape: Rectangular Bracket: Pendant Fixing screw: M10 Reverse light: w/ E-approval: Yes
172014 Reversing Lamp Std pkg 1			Bulb incl.: No Watt: 21 Dim.: 106x83x53 mm Dist. mount. holes: 66 mm	Socket type: BA15S Connection: Screw Colour: Black Colour/glass: White Material: ABS plastic Material/dome: PMMA Shape: Rectangular Fixing screw: 2 Reverse light: w/ Approval: CE E-approval: Yes Alternativ no.: 170932
<h2 style="text-align: center;">REVERSING LAMPS LED</h2>				
170909 LED Fog/Reverse Lamp Std pkg 1		<i>Lens and o-ring: HC-CARGO 170910.</i>		
		Voltage: 12/24 Dim.: 140x88.3 mm OD: 140 mm Dist. mount. holes: 45 mm	Type: LED Fog/Reversing lamp Colour/glass: White Material: Shockproof plastic Shape: Round Fixing screw: 2 Rear/fog lamp: w/ Tail light: w/ LEDs: w/ No./LEDs: 4 E-approval: Yes	
171684 LED Reversing Lamp Std pkg 1		<i>Can be flush mounted by using HC-CARGO 171266.</i>		
		Voltage: 9-33 Watt: 8 Dim.: 140x52.5 mm Dist. mount. holes: 45 mm	Type: LED Reversing lamp Connection: Terminal Colour: Transparent Material: Shockproof plastic Shape: Round No./LEDs: 61 Approval: ECE R23 E-approval: Yes	
172007 LED Reversing Lamp Std pkg 1			Voltage: 10-30 Watt: 18 Kelvin: 6000 Lumen: 1260 Dim.: 89x58 mm	Type: LED Reversing lamp Bulb type: 6 LED Material: Cast aluminum Material/dome: Polycarbonate Shape: Round Reverse light: w/ Tightness norm: IP 67 Approval: ECE R23 E-approval: Yes

SPARE PARTS
170910 Lens, Rear Lamp

Std pkg 1 Servicing: HC-CARGO 170909

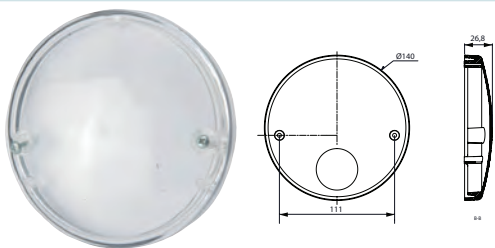
 Dim.: 140x26.8 mm
 Dist. mount. holes:
 111 mm

 Colour: White
 Shape: Round

REAR FOG LAMPS CONVENTIONAL
170688 Rear Fog Lamp

Std pkg 1

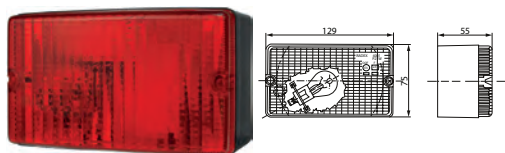

 Bulb incl.: No
 Watt: 21

 Dim.: 129x75x55 mm
 Dist. mount. holes:
 56 mm

 Socket type: BA15S
 Connection: Terminal
 Shape: Rectangular
 Bracket: Straight
 Rear/fog lamp: w/
 E-approval: Yes

170928 Rear Fog Lamp

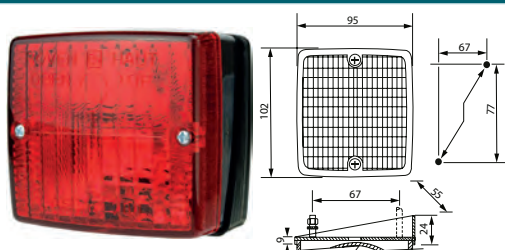
Std pkg 1



 Bulb incl.: No
 Watt: 21

 Dim.: 102x95x55 mm
 Dist. mount. holes:
 77 mm

 Socket type: BA15S
 Colour: Black
 Material: Shockproof plastic
 Shape: Rectangular
 Fixing screw: 2
 E-approval: Yes

170930 Rear Fog Lamp

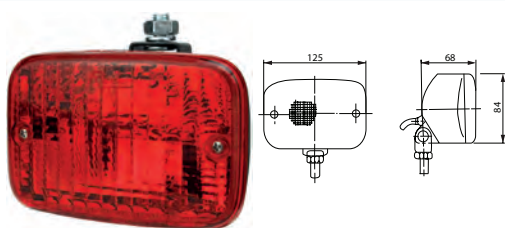
Std pkg 1



 Bulb incl.: No
 Watt: 21

Dim.: 125x84x68 mm

 Socket type: BA15S
 Connection: Terminal
 Colour: Black
 Material: Shockproof plastic
 Shape: Rectangular
 Bracket: Pendant
 Fixing screw: 1
 Rear/fog lamp: w/
 E-approval: Yes

172117 Rear Fog Lamp

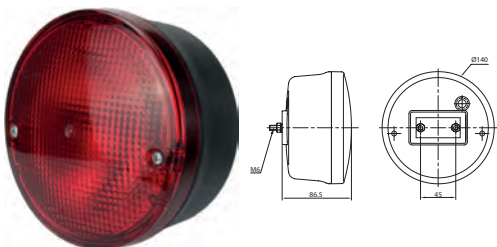
Std pkg 1

 Bulb incl.: No
 Watt: 21

 Dim.: 140x86.5 mm
 Dist. mount. holes:
 45 mm

 Socket type: BA15S
 Connection: Terminal
 Colour: Black
 Colour/glass: Red
 Material: Shockproof plastic
 Shape: Round
 Fixing screw: 2
 Rear/fog lamp: w/
 E-approval: Yes

REAR FOG LAMPS LED
170909 LED Fog/Reverse Lamp

Std pkg 1

Lens and o-ring: HC-CARGO 170910.



Voltage: 12/24

 Dim.: 140x88.3 mm
 OD: 140 mm
 Dist. mount. holes:
 45 mm

 Type: LED Fog/Reversing lamp
 Colour/glass: White
 Material: Shockproof plastic
 Shape: Round
 Fixing screw: 2
 Rear/fog lamp: w/
 Tail light: w/
 LEDs: w/
 No./LEDs: 4
 E-approval: Yes

171685 LED Rear Fog Lamp Std pkg 1

Can be flush mounted by using HC-CARGO 171266.

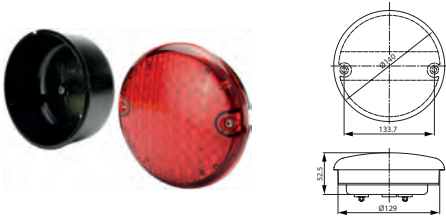

Voltage: 9-33

Dim.: 140x52.5 mm
Dist. mount. holes:
45 mm

Type: Rear fog lamp
Connection: Terminal
Colour: Red
Material: Shockproof plastic
Shape: Round
Rear/fog lamp: w/
No./LEDs: 61

SPARE PARTS

170910 Lens, Rear Lamp Std pkg 1 Servicing: HC-CARGO 170909

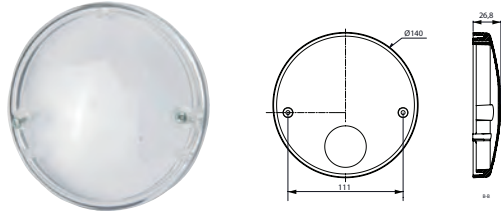

Dim.: 140x26.8 mm
Dist. mount. holes:
111 mm

Colour: White
Shape: Round

MULTI FUNCTION LAMPS

TRAILER LAMPS CONVENTIONAL

170685 Multi Function Lamp Std pkg 1

Lens: HC-CARGO 170687.

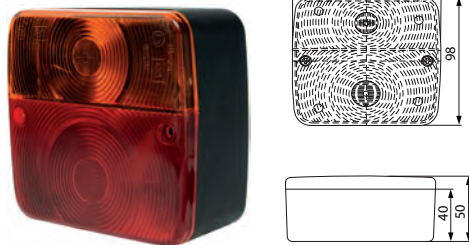

Bulb incl.: No
Watt: 21
Watt 2: 21/5

Dim.: 104x98x50 mm
Dist. mount. holes:
45/55 mm

Socket type: BA15S
Socket type 2: BAY15d
Connection: Terminal
Material: Shockproof plastic
Shape: Square
Fixing screw: 2
Flasher light: w/
Numberplate light: w/ w/o
Rear/fog lamp: w/o
Reverse light: w/o
Sidemarker: w/o
Sidemarker lamp: w/o
Tail light: w/
Stop light: w/
RH/LH: RH/LH
E-approval: Yes

170846 Multi Function Lamp Std pkg 1

Lens: HC-CARGO 170847.

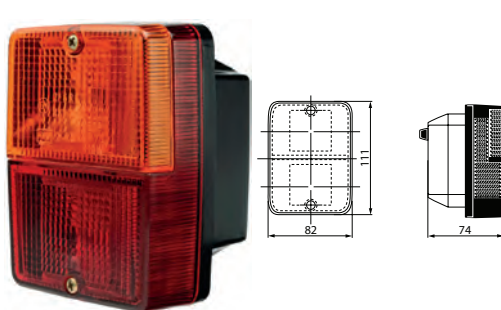

Bulb incl.: No
Watt: 10
Watt 2: 21/5

Dim.: 111x82x74 mm
Dist. mount. holes:
57/87 mm

Socket type: BA15S
Socket type 2: BAY15d
Connection: Terminal
Material: Shockproof plastic
Shape: Rectangular
Fixing screw: 4
Flasher light: w/
Numberplate light: w/o
Rear/fog lamp: w/o
Reverse light: w/o
Sidemarker: w/o
Sidemarker lamp: w/o
Tail light: w/
Stop light: w/
RH/LH: RH/LH
E-approval: Yes

170939 Multi Function Lamp Std pkg 1 Servicing: HC-CARGO 170809, 170828, 170829, 170835, 171049, 171935

Lens: HC-CARGO 170833.

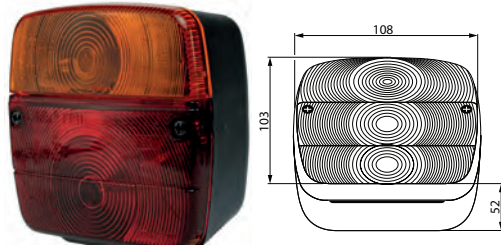

Bulb incl.: No
Watt: 21
Watt 2: 21/5

Dim.: 108x103x52 mm
Dist. mount. holes:
45/55 mm

Socket type: BA15S
Socket type 2: BAY15d
Connection: Terminal
Material: Shockproof plastic
Shape: Square
Fixing screw: 2
Flasher light: w/
Numberplate light: w/o
Rear/fog lamp: w/o
Reverse light: w/o
Sidemarker: w/o
Sidemarker lamp: w/o
Tail light: w/
Stop light: w/
RH/LH: RH/LH
E-approval: Yes

170940 Multi Function Lamp Std pkg 1 Servicing: HC-CARGO 170829

Lens: HC-CARGO 170833.

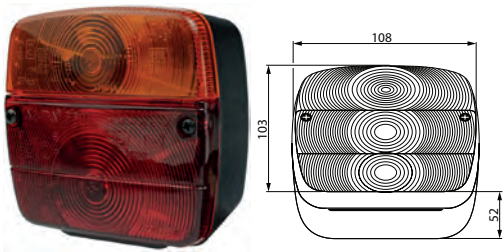

Bulb incl.: No
Watt: 21
Watt 2: 21/5

Dim.: 108x103x52 mm
Dist. mount. holes:
45/55 mm

Socket type: BA15S
Socket type 2: BAY15d
Connection: Terminal
Material: Shockproof plastic
Shape: Square
Fixing screw: 2
Flasher light: w/
Numberplate light: w/
Rear/fog lamp: w/o
Reverse light: w/o
Sidemarker: w/o
Sidemarker lamp: w/o
Tail light: w/
Stop light: w/
RH/LH: RH/LH
E-approval: Yes

170943 Multi Function Lamp Std pkg 1

Lens: HC-CARGO 170944.

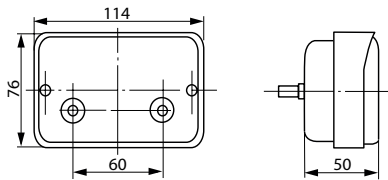

Bulb incl.: No
Watt: 21
Watt 2: 21/5

Dim.: 114x76x50 mm
Dist. mount. holes:
60 mm

Socket type: BA15S
Socket type 2: BAY15d
Connection: Terminal
Material: Shockproof plastic
Shape: Rectangular
Fixing screw: 2
Flasher light: w/
Numberplate light: w/o
Rear/fog lamp: w/o
Reverse light: w/o
Sidemarker: w/o
Sidemarker lamp: w/o
Tail light: w/
Stop light: w/
RH/LH: RH/LH
E-approval: Yes

170985 Multi Function Lamp Std pkg 1

Lens: HC-CARGO 170987.

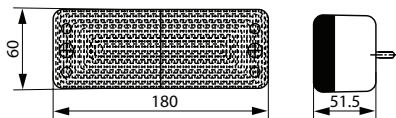

Bulb incl.: No
Watt: 10
Watt 2: 21/5

Dim.: 180x60x51.5 mm
Dist. mount. holes:
134 mm

Socket type: BA15S
Socket type 2: BAY15d
Connection: Terminal
Material: Shockproof plastic
Shape: Rectangular
Fixing screw: 2
Flasher light: w/
Numberplate light: w/o
Rear/fog lamp: w/o
Reverse light: w/o
Sidemarker: w/o
Sidemarker lamp: w/o
Tail light: w/
Stop light: w/
RH/LH: RH/LH
E-approval: Yes

170986 Multi Function Lamp Std pkg 1

Lens: HC-CARGO 170987.

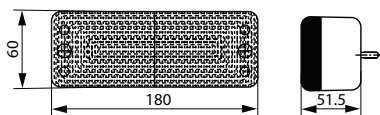

Bulb incl.: No
Watt: 10
Watt 2: 21/5

Dim.: 180x60x51.5 mm
Dist. mount. holes:
134 mm

Socket type: BA15S
Socket type 2: BAY15d
Connection: Terminal
Material: Shockproof plastic
Shape: Rectangular
Fixing screw: 2
Flasher light: w/
Numberplate light: w/
Rear/fog lamp: w/o
Reverse light: w/o
Sidemarker: w/o
Sidemarker lamp: w/o
Tail light: w/
Stop light: w/
RH/LH: RH/LH
E-approval: Yes

171013 Multi Function Lamp Std pkg 1

Lens: HC-CARGO 171015. Right: HC-CARGO 171014.

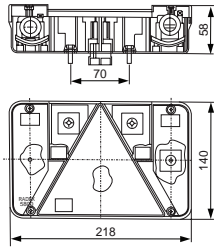

Bulb incl.: No
Watt: 21
Watt 2: 21/5

Dim.: 218x140x58 mm
Dist. mount. holes:
70 mm

Socket type: BA15S
Socket type 2: BAY15d
Connection: Terminal
Material: Shockproof plastic
Shape: Rectangular
Reflector: w/
Fixing screw: 2
Flasher light: w/
Numberplate light: w/
Rear/fog lamp: w/o
Reverse light: w/o
Sidemarker: w/o
Sidemarker lamp: w/o
Tail light: w/
Stop light: w/
RH/LH: LH
E-approval: Yes

171014 Multi Function Lamp Std pkg 1

Lens: HC-CARGO 171016. Left: HC-CARGO 171013.

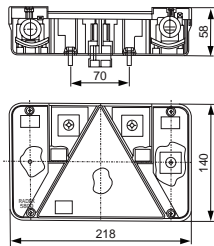

Bulb incl.: No
Watt: 21
Watt 2: 21/5

Dim.: 218x140x58 mm
Dist. mount. holes:
70 mm

Socket type: BA15S
Socket type 2: BAY15d
Connection: Terminal
Material: Shockproof plastic
Shape: Rectangular
Reflector: w/
Fixing screw: 2
Flasher light: w/
Numberplate light: w/
Rear/fog lamp: w/o
Reverse light: w/o
Sidemarker: w/o
Sidemarker lamp: w/o
Tail light: w/
Stop light: w/
RH/LH: RH

171050 Multi Function Lamp Std pkg 1

Lens: HC-CARGO 171057. Plug: HC-CARGO 171372, 171373. Right: HC-CARGO 171053.

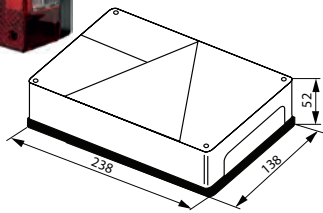

Bulb incl.: Yes
Watt: 21
Watt 2: 21/5
Watt 3: 5

Dim.: 238x138x52 mm
Dist. mount. holes:
152 mm

Socket type: BA15S
Socket type 2: BAY15d
Socket type 3: S8.5
Material: Shockproof plastic
Shape: Rectangular
Reflector: w/
Fixing screw: 2
Flasher light: w/
Numberplate light: w/
Rear/fog lamp: w/
Reverse light: w/o
Sidemarker: w/o
Sidemarker lamp: w/o
Tail light: w/
Stop light: w/
RH/LH: LH
E-approval: Yes

171051 Multi Function Lamp Std pkg 1

Lens: HC-CARGO 171056. Plug: HC-CARGO 171372, 171373. Left: HC-CARGO 171054.

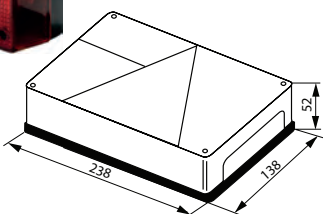

Bulb incl.: Yes
Watt: 21
Watt 2: 21/5
Watt 3: 5

Dim.: 238x138x52 mm
Dist. mount. holes:
152 mm

Socket type: BA15S
Socket type 2: BAY15d
Socket type 3: S8.5
Material: Shockproof plastic
Shape: Rectangular
Reflector: w/
Fixing screw: 2
Flasher light: w/
Numberplate light: w/
Rear/fog lamp: w/o
Reverse light: w/o
Sidemarker: w/o
Sidemarker lamp: w/o
Tail light: w/
Stop light: w/
RH/LH: RH
E-approval: Yes

171052 Multi Function Lamp Std pkg 1

Lens: HC-CARGO 171058. Supplied w/ HC-CARGO 171372, 171373. Left: HC-CARGO 171055.

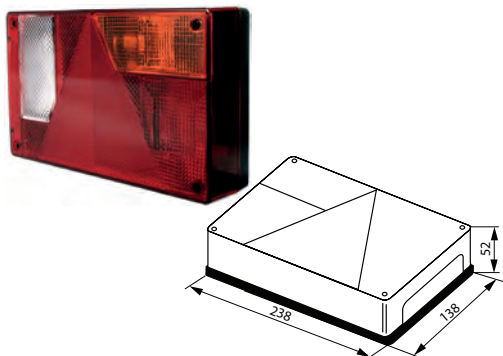

 Bulb incl.: Yes
 Watt: 21
 Watt 2: 21/5
 Watt 3: 5

 Dim.: 238x138x52 mm
 Dist. mount. holes:
 152 mm

 Socket type: BA15S
 Socket type 2: BAY15d
 Socket type 3: S8.5
 Material: Shockproof plastic
 Shape: Rectangular
Reflector: w/
 Fixing screw: 2
 Flasher light: w/
 Numberplate light: w/
 Rear/fog lamp: w/o
 Reverse light: w/
 Sidemarker: w/o
 Sidemarker lamp: w/o
 Tail light: w/
 Stop light: w/
 RH/LH: RH
 E-approval: Yes

171053 Multi Function Lamp Std pkg 1

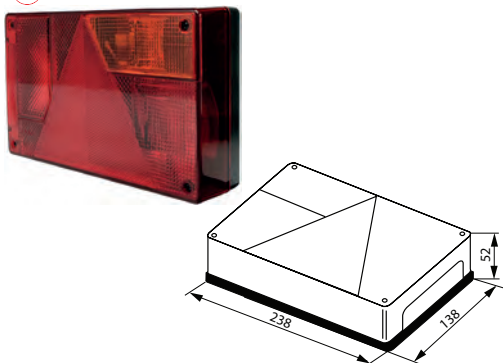
Lens: HC-CARGO 171056. Multi Connector: HC-CARGO 171372, 171373. Left: HC-CARGO 171050.



 Bulb incl.: Yes
 Watt: 21
 Watt 2: 21/5
 Watt 3: 5

 Dim.: 238x138x52 mm
 Dist. mount. holes:
 152 mm

 Socket type: BA15S
 Socket type 2: BAY15d
 Socket type 3: S8.5
 Material: Shockproof plastic
 Shape: Rectangular
Reflector: w/
 Fixing screw: 2
 Flasher light: w/
 Numberplate light: w/
 Rear/fog lamp: w/
 Reverse light: w/o
 Sidemarker: w/o
 Sidemarker lamp: w/o
 Tail light: w/
 Stop light: w/
 RH/LH: RH
 E-approval: Yes

171054 Multi Function Lamp Std pkg 1

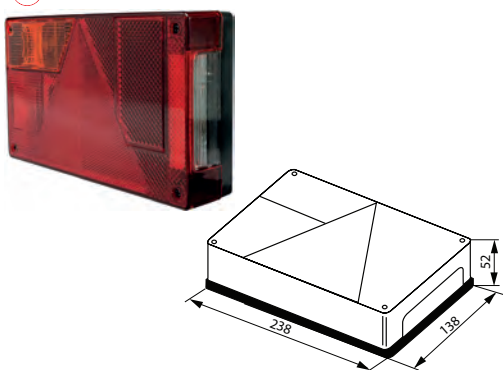
Lens: HC-CARGO 171057. Plug: HC-CARGO 171372, 171373. Right: HC-CARGO 171051.



 Bulb incl.: No
 Watt: 21
 Watt 2: 21/5
 Watt 3: 5

 Dim.: 238x138x52 mm
 Dist. mount. holes:
 152 mm

 Socket type: BA15S
 Socket type 2: BAY15d
 Socket type 3: S8.5
 Material: Shockproof plastic
 Shape: Rectangular
Reflector: w/
 Fixing screw: 2
 Flasher light: w/
 Numberplate light: w/
 Rear/fog lamp: w/o
 Reverse light: w/o
 Sidemarker: w/o
 Sidemarker lamp: w/o
 Tail light: w/
 Stop light: w/
 RH/LH: LH
 E-approval: Yes

171055 Multi Function Lamp Std pkg 1

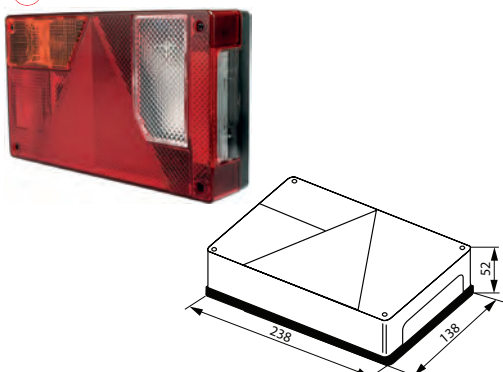
Lens: HC-CARGO 171059. Plug: HC-CARGO 171372, 171373. Right: HC-CARGO 171052.



 Bulb incl.: No
 Watt: 21
 Watt 2: 21/5
 Watt 3: 5

 Dim.: 238x138x52 mm
 Dist. mount. holes:
 152 mm

 Socket type: BA15S
 Socket type 2: BAY15d
 Socket type 3: S8.5
 Material: Shockproof plastic
 Shape: Rectangular
Reflector: w/
 Fixing screw: 2
 Flasher light: w/
 Numberplate light: w/
 Rear/fog lamp: w/o
 Reverse light: w/
 Sidemarker: w/o
 Sidemarker lamp: w/o
 Tail light: w/
 Stop light: w/
 RH/LH: LH
 E-approval: Yes

171202 Multi Function Lamp Std pkg 2

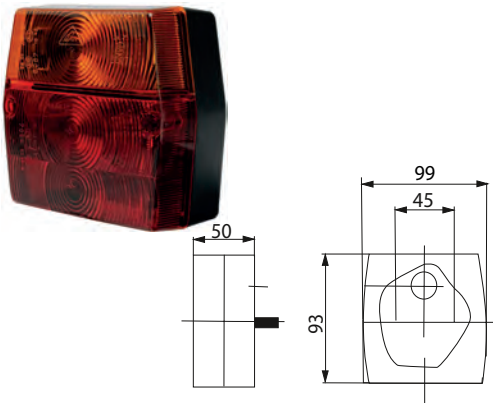
Lens: HC-CARGO 171253.



Bulb incl.: No
Watt: 10
Watt 2: 21/5

Dim.: 93x99x50 mm
Dist. mount. holes:
45 mm

Socket type: BA15S
Socket type 2: BAY15d
Connection: Terminal
Material: Shockproof plastic
Shape: Hexagon
Fixing screw: 2
Flasher light: w/
Numberplate light: w/o
Rear/fog lamp: w/o
Reverse light: w/o
Sidemarker: w/o
Sidemarker lamp: w/o
Tail light: w/
Stop light: w/
RH/LH: RH/LH
E-approval: Yes

171213 Multi Function Lamp Std pkg 1

Lens: HC-CARGO 171264. Right: HC-CARGO 171214.

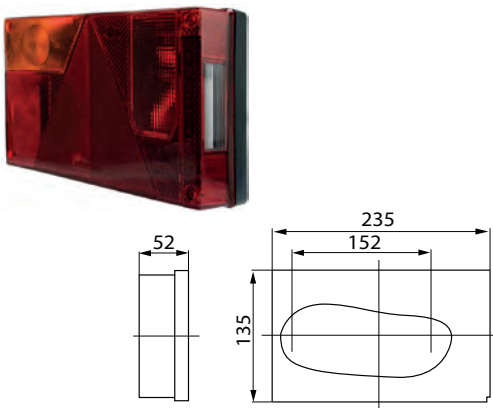

Bulb incl.: No
Watt: 21
Watt 2: 21/5
Watt 3: 5

Dim.: 235x135x52 mm
Dist. mount. holes:
152 mm

Socket type: BA15S
Socket type 2: BAY15d
Socket type 3: S8.5
Connection: Terminal
Material: Shockproof plastic
Shape: Rectangular
Reflector: w/
Fixing screw: 2
Flasher light: w/
Numberplate light: w/
Rear/fog lamp: w/o
Reverse light: w/o
Sidemarker: w/o
Sidemarker lamp: w/o
Tail light: w/
Stop light: w/
RH/LH: LH
E-approval: Yes
Alternativ no.: 171050

171328 Multi Function Lamp Std pkg 1

Lens: HC-CARGO 171330.

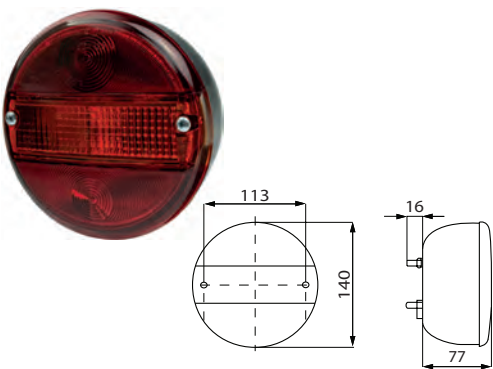

Bulb incl.: No
Watt: 21
Watt 2: 5

Dim.: 140x77 mm
OD: 140 mm
Dist. mount. holes:
45 mm

Socket type: BA15S
Socket type 2: BA15S
Connection: Terminal
Material: Shockproof plastic
Shape: Round
Fixing screw: 2
Flasher light: w/
Numberplate light: w/
Rear/fog lamp: w/o
Reverse light: w/o
Sidemarker: w/o
Sidemarker lamp: w/o
Tail light: w/
Stop light: w/
E-approval: Yes

171329 Multi Function Lamp Std pkg 1

Mounting kit: HC-CARGO 171266. Lens: HC-CARGO 171330.

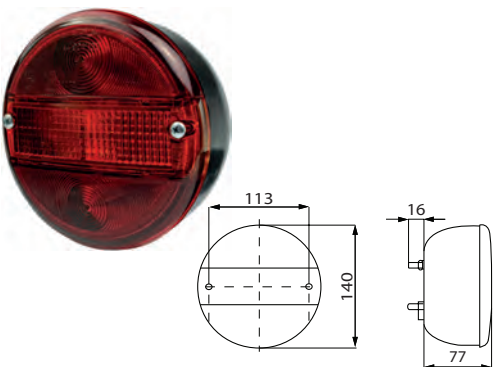

Bulb incl.: No
Watt: 21
Watt 2: 5

Dim.: 140x77 mm
OD: 140 mm
Dist. mount. holes:
45 mm

Socket type: BA15S
Socket type 2: BA15S
Connection: Terminal
Material: Shockproof plastic
Shape: Round
Fixing screw: 2
Flasher light: w/
Numberplate light: w/o
Rear/fog lamp: w/o
Reverse light: w/o
Sidemarker: w/o
Sidemarker lamp: w/o
Tail light: w/
Stop light: w/
E-approval: Yes

171533 Multi Function Lamp Std pkg 1

Lens: HC-CARGO 171015. Plug: HC-CARGO 171537, 171538. Right: HC-CARGO 171534.

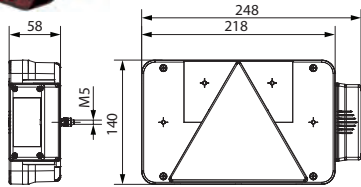

Bulb incl.: No
Watt: 21
Watt 2: 21/5
Watt 3: 5

Dim.: 248x140x58 mm
Dist. mount. holes:
70 mm

Socket type: BA15S
Socket type 2: BAY15d
Socket type 3: S8.5
Material: Shockproof plastic
Shape: Rectangular
Reflector: w/
Fixing screw: 2
Flasher light: w/
Numberplate light: w/
Rear/fog lamp: w/o
Reverse light: w/o
Sidemarker: w/o
Sidemarker lamp: w/o
Tail light: w/
Stop light: w/
RH/LH: LH
E-approval: Yes

171534 Multi Function Lamp Std pkg 1

Lens: HC-CARGO 171016. Plug: HC-CARGO 171537, 171538. Left: HC-CARGO 171533.

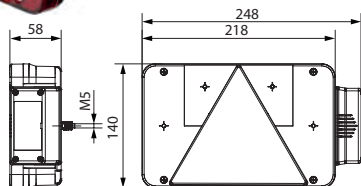

Bulb incl.: No
Watt: 21
Watt 2: 21/5
Watt 3: 5

Dim.: 248x140x58 mm
Dist. mount. holes:
70 mm

Socket type: BA15S
Socket type 2: BAY15d
Socket type 3: S8.5
Material: Shockproof plastic
Shape: Rectangular
Reflector: w/
Fixing screw: 2
Flasher light: w/
Numberplate light: w/
Rear/fog lamp: w/o
Reverse light: w/o
Sidemarker: w/o
Sidemarker lamp: w/o
Tail light: w/
Stop light: w/
RH/LH: RH
E-approval: Yes

171822 Multi Function Lamp Std pkg 1 Servicing: HC-CARGO 171821

Multi connector: HC-CARGO 171372, 171373. Lens: HC-CARGO 170833.

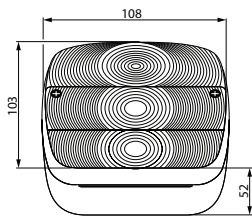

Bulb incl.: Yes
Watt: 21
Watt 2: 21/5

Dim.: 108x103x52 mm
Dist. mount. holes:
45/55 mm

Socket type: BA15S
Socket type 2: BAY15d
Connection: Multiplug
Shape: Square
Flasher light: w/
Numberplate light: w/o
Rear/fog lamp: w/o
Reverse light: w/o
Sidemarker: w/
Sidemarker lamp: w/o
Tail light: w/o
Stop light: w/
E-approval: Yes

171917 Multi Function Lamp Std pkg 1

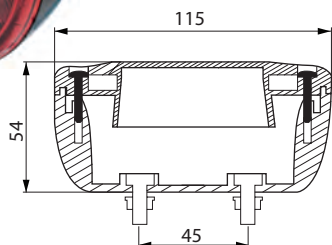

Bulb incl.: No
Watt: 5
Watt 2: 18
Watt 3: 18

Dim.: 115x54 mm
OD: 115 mm
Dist. mount. holes:
45 mm

Bulb type: 10.5x36 mm
Bulb type 2: 15x41 mm
Bulb type 3: 15x41 mm
Socket type: S8.5
Socket type 2: S8.5
Socket type 3: S8.5
Connection: Terminal
Colour/glass: Red/yellow
Material/dome: PMMA
Shape: Round
Fixing screw: 2
Flasher light: w/
Numberplate light: w/o
Rear/fog lamp: w/o
Reverse light: w/o
Sidemarker: w/o
Sidemarker lamp: w/o
Tail light: w/
Stop light: w/
RH/LH: RH/LH

172021 Multi Function Lamp Std pkg 1

Lens: HC-CARGO 172023. Multi connector: HC-CARGO 171537, 171538. Right: HC-CARGO 172022.

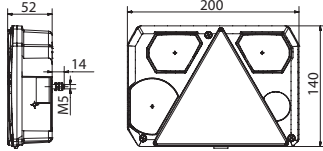

Bulb incl.: No
Watt: 21
Watt 2: 21/5
Watt 3: 5

Dim.: 200x140x52 mm
Dist. mount. holes: 152 mm

Socket type: BA15S
Socket type 2: BAY15d
Socket type 3: S8.5
Connection: Terminal
Material: Shockproof plastic
Shape: Rectangular
Reflector: w/
Fixing screw: 2
Flasher light: w/
Numberplate light: w/
Rear/fog lamp: w/
Reverse light: w/o
Sidemarker: w/o
Sidemarker lamp: w/o
Tail light: w/
Stop light: w/
RH/LH: LH
E-approval: Yes

172022 Multi Function Lamp Std pkg 1

Lens: HC-CARGO 172024. Multi connector: HC-CARGO 171537, 171538. Left: HC-CARGO 172021.

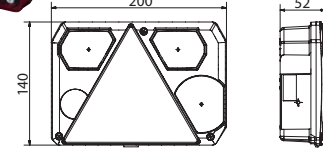

Bulb incl.: No
Watt: 21
Watt 2: 21/5
Watt 3: 5

Dim.: 200x140x52 mm
Dist. mount. holes: 152 mm

Socket type: BA15S
Socket type 2: BAY15d
Socket type 3: S8.5
Connection: Terminal
Material: Shockproof plastic
Shape: Rectangular
Reflector: w/
Fixing screw: 2
Flasher light: w/
Numberplate light: w/
Rear/fog lamp: w/o
Reverse light: w/
Sidemarker: w/o
Sidemarker lamp: w/o
Tail light: w/
Stop light: w/
RH/LH: RH
E-approval: Yes

172025 Multi Function Lamp Std pkg 1

Lens: HC-CARGO 172023. Plug: HC-CARGO 171537, 171538. Right: HC-CARGO 172026.

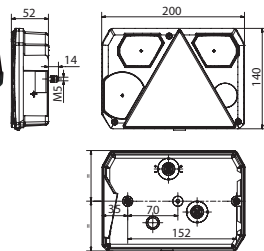

Bulb incl.: Yes
Voltage: 12
Watt: 21
Watt 2: 21/5
Watt 3: 5

Dim.: 200x140x52 mm
Dist. mount. holes: 152 mm

Socket type: BA15S
Socket type 2: BAY15d
Socket type 3: S8.5
Connection: Multiplug
Material: Shockproof plastic
Shape: Rectangular
Reflector: w/
Fixing screw: 2
Flasher light: w/
Numberplate light: w/
Rear/fog lamp: w/
Reverse light: w/o
Sidemarker: w/o
Sidemarker lamp: w/o
Tail light: w/
Stop light: w/
RH/LH: LH
E-approval: Yes

172026 Multi Function Lamp Std pkg 1

Lens: HC-CARGO 172024. Plug: HC-CARGO 171537, 171538. Left: HC-CARGO 172025.

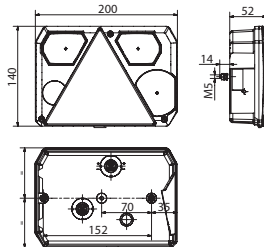

Bulb incl.: Yes
Voltage: 12
Watt: 21
Watt 2: 21/5
Watt 3: 5

Dim.: 200x140x52 mm
Dist. mount. holes: 152 mm

Socket type: BA15S
Socket type 2: BAY15d
Socket type 3: S8.5
Connection: Multiplug
Material: Shockproof plastic
Shape: Rectangular
Reflector: w/
Fixing screw: 2
Flasher light: w/
Numberplate light: w/
Rear/fog lamp: w/o
Reverse light: w/
Sidemarker: w/o
Sidemarker lamp: w/o
Tail light: w/
Stop light: w/
RH/LH: RH
E-approval: Yes

172047 Multi Function Lamp Std pkg 1

Lens: HC-CARGO 172051. Plug: HC-CARGO 171537, 171538. Right: HC-CARGO 172048.

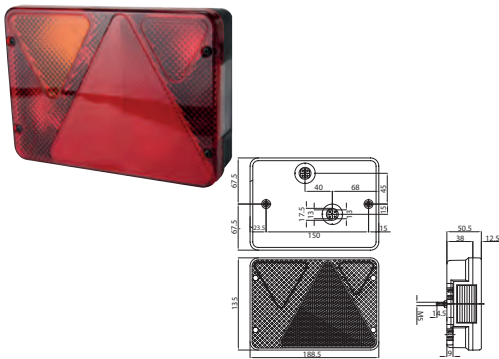

Bulb incl.: Yes
Voltage: 12
Watt: 21
Watt 2: 21/5
Watt 3: 5

Dim.:
188.5x135x50.5 mm
Dist. mount. holes:
150 mm

Socket type: BA15S
Socket type 2: BAY15d
Socket type 3: S8.5
Connection: Multiplug
Colour: Black
Material: Polypropylene
Material/dome: PMMA
Shape: Rectangular
Reflector: w/
Fixing screw: 2
Flasher light: w/
Numberplate light: w/
Rear/fog lamp: w/
Reverse light: w/o
Sidemarker: w/o
Sidemarker lamp: w/o
Tail light: w/
Stop light: w/
RH/LH: LH
E-approval: Yes

172048 Multi Function Lamp Std pkg 1

Lens: HC-CARGO 172052. Plug: HC-CARGO 171537, 171538. Left: HC-CARGO 172047.

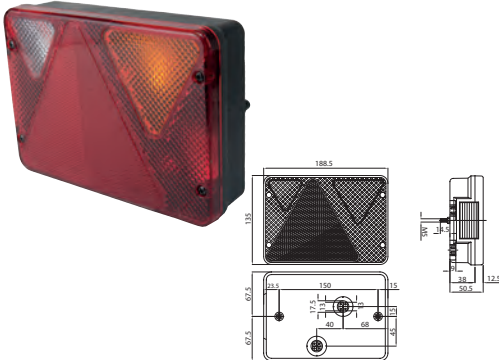

Bulb incl.: Yes
Voltage: 12
Watt: 21
Watt 2: 21/5
Watt 3: 5

Dim.:
188.5x135x50.5 mm
Dist. mount. holes:
150 mm

Socket type: BA15S
Socket type 2: BAY15d
Socket type 3: S8.5
Connection: Multiplug
Colour: Black
Material: Polypropylene
Material/dome: PMMA
Shape: Rectangular
Reflector: w/
Fixing screw: 2
Flasher light: w/
Numberplate light: w/
Rear/fog lamp: w/
Reverse light: w/o
Sidemarker: w/o
Sidemarker lamp: w/o
Tail light: w/
Stop light: w/
RH/LH: RH
E-approval: Yes

172049 Multi Function Lamp Std pkg 1 Servicing: UK - Visit our web catalogue for further information

Lens: HC-CARGO 172057. Plug: HC-CARGO 171537, 171538. Left: HC-CARGO 172050.

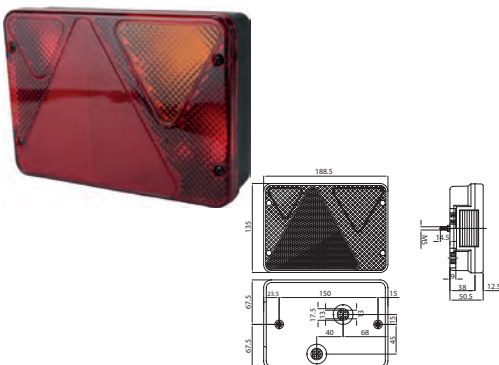

Bulb incl.: Yes
Voltage: 12
Watt: 21
Watt 2: 21/5
Watt 3: 5

Dim.:
188.5x135x50.5 mm
Dist. mount. holes:
150 mm

Socket type: BA15S
Socket type 2: BAY15d
Socket type 3: S8.5
Connection: Multiplug
Colour: Black
Material: Polypropylene
Material/dome: PMMA
Shape: Rectangular
Reflector: w/
Fixing screw: 2
Flasher light: w/
Numberplate light: w/
Rear/fog lamp: w/
Reverse light: w/o
Sidemarker: w/o
Sidemarker lamp: w/o
Tail light: w/
Stop light: w/
RH/LH: RH
E-approval: Yes

172050 Multi Function Lamp Std pkg 1 Servicing: UK - Visit our web catalogue for further information

Lens: HC-CARGO 172058. Plug: HC-CARGO 171537, 171538. Right: HC-CARGO 172049.

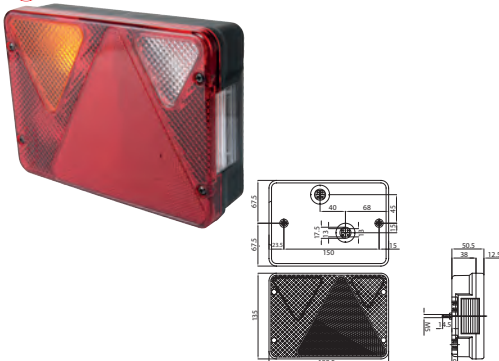

Bulb incl.: Yes
Voltage: 12
Watt: 21
Watt 2: 21/5
Watt 3: 5

Dim.:
188.5x135x50.5 mm
Dist. mount. holes:
150 mm

Socket type: BA15S
Socket type 2: BAY15d
Socket type 3: S8.5
Connection: Multiplug
Colour: Black
Material: Polypropylene
Material/dome: PMMA
Shape: Rectangular
Reflector: w/
Fixing screw: 2
Flasher light: w/
Numberplate light: w/
Rear/fog lamp: w/
Reverse light: w/o
Sidemarker: w/o
Sidemarker lamp: w/o
Tail light: w/
Stop light: w/
RH/LH: LH
E-approval: Yes

172068 Multi Function Lamp Std pkg 1

Lens: HC-CARGO 172070. Plug: HC-CARGO 171537, 171538. Right: HC-CARGO 172069.

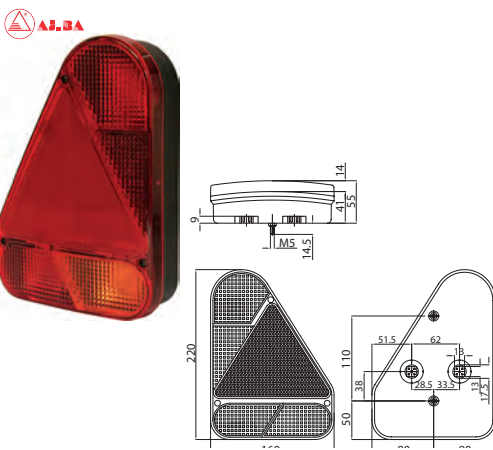

Bulb incl.: Yes
Voltage: 12
Watt: 21/5
Watt 2: 21

Dim.: 220x160x55 mm
Dist. mount. holes:
110 mm

Socket type: BAY15d
Socket type 2: BA15S
Connection: Multiplug
Colour: Black
Material: Polypropylene
Material/dome: Polycarbonate
Shape: Triangle
Reflector: w/
Fixing screw: 2
Flasher light: w/
Numberplate light: w/o
Rear/fog lamp: w/
Reverse light: w/o
Sidemarker: w/o
Sidemarker lamp: w/o
Tail light: w/
Stop light: w/
RH/LH: LH
E-approval: Yes

172069 Multi Function Lamp Std pkg 1

Lens: HC-CARGO 172071. Plug: HC-CARGO 171537, 171538. Right: HC-CARGO 172068.

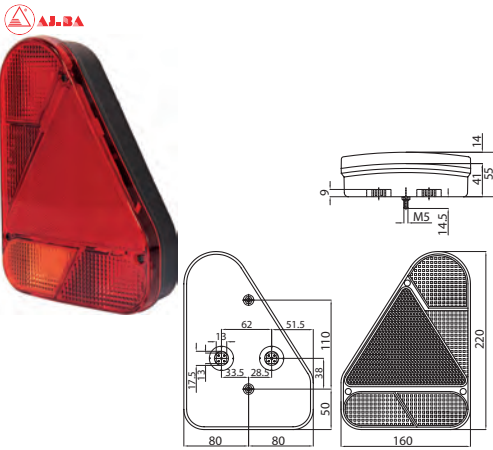

Bulb incl.: Yes
Voltage: 12
Watt: 21/5
Watt 2: 21

Dim.: 220x160x55 mm
Dist. mount. holes:
110 mm

Socket type: BAY15d
Socket type 2: BA15S
Connection: Multiplug
Colour: Black
Material: Polypropylene
Material/dome: Polycarbonate
Shape: Triangle
Reflector: w/
Fixing screw: 2
Flasher light: w/
Numberplate light: w/o
Rear/fog lamp: w/
Reverse light: w/o
Sidemarker: w/o
Sidemarker lamp: w/o
Tail light: w/
Stop light: w/
RH/LH: RH
E-approval: Yes

172153 Multi Function Lamp Std pkg 1

Right: HC-CARGO 172154.



Bulb incl.: Yes
Voltage: 12
Watt: 5

Dim.: 63x149x245 mm
Dist. mount. holes:
152 mm

Socket type: P21
Connection: Multiplug
Colour: Black
Material: Shockproof plastic
Shape: Rectangular
Reflector: w/
Flasher light: w/
Numberplate light: w/
Rear/fog lamp: w/
Sidemarker: w/
Stop light: w/
RH/LH: LH
E-approval: Yes

172154 Multi Function Lamp Std pkg 1











Left: HC-CARGO 172153.

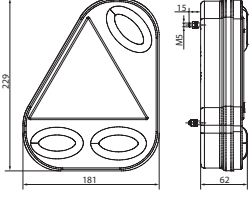

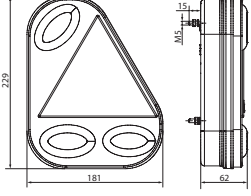



















Bulb incl.: Yes
Voltage: 12
Watt: 5





Dim.: 63x149x245 mm
Dist. mount. holes:
152 mm

Socket type: P21
Connection: Multiplug
Colour: Black
Material/dome: Shockproof plastic
Shape: Rectangular
Reflector: w/
Flasher light: w/
Numberplate light: w/
Reverse light: w/
Sidemarker: w/
Stop light: w/
RH/LH: RH
E-approval: Yes

172155 Multi Function Lamp Std pkg 1 <i>Right: HC-CARGO 172156.</i>					
  			Bulb incl.: Yes Voltage: 12 Watt: 5	Dim.: 62x181x229 mm Dist. mount. holes: 130 mm	Socket type: P21 Colour: Black Colour/glass: Red Shape: Triangle Reflector: w/ Flasher light: w/ Numberplate light: w/ Rear/fog lamp: w/ Sidemarkers: w/ Stop light: w/ RH/LH: LH E-approval: Yes
172156 Multi Function Lamp Std pkg 1 <i>Left: HC-CARGO 172155.</i>					
  			Bulb incl.: Yes Voltage: 12 Watt: 5	Dim.: 62x181x229 mm Dist. mount. holes: 130 mm	Socket type: P21 Colour: Black Shape: Triangle Reflector: w/ Flasher light: w/ Numberplate light: w/ Reverse light: w/ Sidemarkers: w/ Stop light: w/ RH/LH: RH E-approval: Yes
SPARE PARTS					
170687 Lens, Rear Lamp Std pkg 1 Servicing: HC-CARGO 170685					
 				Dim.: 104x98 mm	Shape: Square RH/LH: RH/LH
170833 Lens, Rear Lamp Std pkg 1 Servicing: HC-CARGO 170939, 170940, 171821, 171822, 171873					
 				Dim.: 108x103x52 mm	Material: Shockproof plastic Shape: Square Flasher light: w/ Numberplate light: w/o Rear/fog lamp: w/o Reverse light: w/o Sidemarkers: w/o Sidemarkers lamp: w/o Tail light: w/ Stop light: w/ RH/LH: RH/LH
170847 Lens, Rear Lamp Std pkg 1 Servicing: HC-CARGO 170846					
				Dim.: 111x82 mm	Material: Shockproof plastic Shape: Rectangular RH/LH: RH/LH
170944 Lens, Rear Lamp Std pkg 1 Servicing: HC-CARGO 170943					
				Dim.: 120x80 mm	Material: Shockproof plastic Shape: Rectangular RH/LH: RH/LH

EL. SPECIFICATIONS		DIMENSIONS	ADDITIONAL SPECIFICATIONS
170987	Lens, Rear Lamp	Std pkg 1 Servicing: HC-CARGO 170985, 170986	
		Dim.: 180x60 mm	Material: Shockproof plastic Shape: Rectangular RH/LH: RH/LH
171015	Lens, Rear Lamp	Std pkg 1 Servicing: HC-CARGO 171013, 171533	
 		Dim.: 218x140 mm	Material: Shockproof plastic Shape: Rectangular Reflector: w/ RH/LH: LH
171016	Lens, Rear Lamp	Std pkg 1 Servicing: HC-CARGO 171534, 171014	
 		Dim.: 218x140 mm	Material: Shockproof plastic Shape: Rectangular Reflector: w/ RH/LH: RH
171056	Lens, Rear Lamp	Std pkg 1 Servicing: HC-CARGO 171051, 171053	
 		Dim.: 235x135x52 mm	Material: Shockproof plastic Shape: Rectangular Reflector: w/ Numberplate light: w/ RH/LH: RH
171057	Lens, Rear Lamp	Std pkg 1 Servicing: HC-CARGO 171050, 171054	
 		Dim.: 235x135x52 mm	Material: Shockproof plastic Shape: Rectangular Reflector: w/ Numberplate light: w/ RH/LH: LH
171058	Lens, Rear Lamp	Std pkg 1 Servicing: HC-CARGO 171052	
 		Dim.: 235x135 mm	Material: Shockproof plastic Shape: Rectangular Reflector: w/ Numberplate light: w/ RH/LH: RH
171059	Lens, Rear Lamp	Std pkg 1 Servicing: HC-CARGO 171055	
 		Dim.: 235x135 mm	Material: Shockproof plastic Shape: Rectangular Reflector: w/ Numberplate light: w/ RH/LH: LH

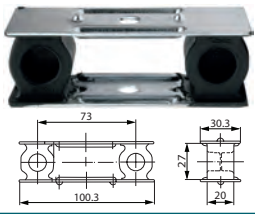
EL. SPECIFICATIONS		DIMENSIONS	ADDITIONAL SPECIFICATIONS
171162	Lens, Rear Lamp	Std pkg 1	Servicing: Ford Transit 1986 - Visit our web catalogue for further information
		Dim.: 364x94 mm	Material: Shockproof plastic Shape: Rectangular Reflector: w/ E-approval: Yes
171330	Lens, Rear Lamp	Std pkg 1	Servicing: HC-CARGO 171328, 171329
		OD: 140 mm	Shape: Round RH/LH: RH/LH
172023	Lens, Rear Lamp	Std pkg 1	Servicing: HC-CARGO 172021, 172025
		Dim.: 200x140 mm	Shape: Rectangular Reflector: w/ RH/LH: LH
172024	Lens, Rear Lamp	Std pkg 1	Servicing: HC-CARGO 172022, 172026
		Dim.: 200x140 mm	Shape: Rectangular Reflector: w/ Reverse light: w/ RH/LH: RH
172051	Lens, Rear Lamp	Std pkg 1	Servicing: HC-CARGO 172047
		Dim.: 188.5x135 mm	Material/dome: PMMA Shape: Rectangular
172052	Lens, Rear Lamp	Std pkg 1	Servicing: HC-CARGO 172048
		Dim.: 188.5x135 mm	Material: PMMA Shape: Rectangular
172057	Lens, Rear Lamp	Std pkg 1	Servicing: HC-CARGO 172049
		Dim.: 188.5x135 mm	Material/dome: PMMA Shape: Rectangular

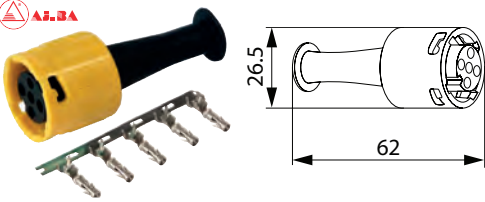
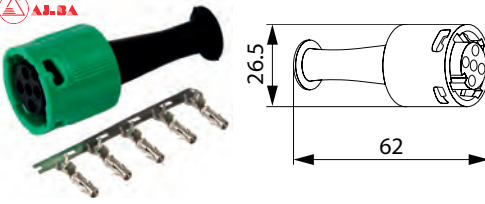
EL. SPECIFICATIONS		DIMENSIONS	ADDITIONAL SPECIFICATIONS
172058	Lens, Rear Lamp Std pkg 1 Servicing: HC-CARGO 172050		Dim.: 188.5x135 mm Material/dome: PMMA Shape: Rectangular
172070	Lens, Rear Lamp Std pkg 1 Servicing: HC-CARGO 172068		Dim.: 220x160 mm Material/dome: Polycarbonate Shape: Rectangular RH/LH: LH
172071	Lens, Rear Lamp Std pkg 1 Servicing: HC-CARGO 172069		Dim.: 220x160 mm Material/dome: Polycarbonate Shape: Rectangular RH/LH: RH
ACCESSORIES			
170604	Vibration Damper Std pkg 2 Servicing: HC-CARGO 170602, 170603 <i>Gives a longer life to the bulbs.</i>		
171266	Mounting kit Std pkg 1 Servicing: HC-CARGO 171192, 171193, 171194, 171195, 171329, 171549, 171550, 171684, 171685 <i>Circulars.</i>		
171372	Multi Connector Std pkg 1 Servicing: HC-CARGO 171050, 171051, 171052, 171053, 171054, 171055, 171818, 171821, 171822, 171873 <i>Socket w/ quick connection. Terminal: HC-CARGO 191075.</i>		Dim.: 62x26.5 mm Colour: Yellow RH/LH: LH E-approval: Yes
171373	Multi Connector Std pkg 1 Servicing: HC-CARGO 171050, 171051, 171052, 171053, 171054, 171055, 171818, 171821, 171822, 171873 <i>Socket w/ quick connection. Terminal: HC-CARGO 191075.</i>		Dim.: 62x26.5 mm Colour: Green RH/LH: RH E-approval: Yes

171537 Multi Connector Std pkg 1		Servicing: HC-CARGO 171533, 171534, 172021, 172022, 172025, 172026, 172047, 172048, 172049, 172050, 172068, 172069, 171870, 171871	
<i>Socket w/ quick connection. Terminal: HC-CARGO 191075.</i>			
		Dim.: 55x28 mm	Colour: Red RH/LH: LH
171538 Multi Connector Std pkg 1		Servicing: HC-CARGO 171533, 171534, 172021, 172022, 172025, 172026, 172047, 172049, 172048, 172050, 172068, 172069, 171871, 171870	
<i>Socket w/ quick connection. Terminal: HC-CARGO 191075.</i>			
		Dim.: 55x28 mm	Colour: Green RH/LH: RH
171788 Multiconnector 7 pin Std pkg 1		Servicing: HC-CARGO 171506, 171756, 171757, 171802, 171803, 171927, 171928, 171929, 171930, 172061, 172062, 172063, 172064, 171700	
<i>Gasket: HC-CARGO 192178. Terminal: HC-CARGO 193250.</i>			
			Type/terminal: Round Connection: M Colour: Black No./poles: 7 Plug: Female
172015 Cable w/ plug Std pkg 2			
<i>Cover of click-in connector: HC-CARGO 172016.</i>			
		Roll size: 1 m	Shape: Round
172016 Cover of click-in connector Std pkg 10		Servicing: HC-CARGO 171730, 171731, 171732, 171733, 171734, 172015	
		ID: 12.8 mm Total length: 30.6 mm Height: 16.3 mm Width: 16.5 mm	
172066 Multiconnector 6 pin Std pkg 1		Servicing: HC-CARGO 171506, 171756, 171757, 171802, 171803, 171927, 171928, 171929, 171930, 172061, 172062, 172063, 172064	
			Type/terminal: Round Connection: J Colour: Black No./poles: 6 Plug: Female
181627 Bayonet connector Std pkg 1		Servicing: HC-CARGO 181617	
		Voltage: 12	Mount.: Terminal No./poles: 8 DIN norm: 72580

TRAILER LAMPS LED
171549 LED Multifunction Lamp Std pkg 1

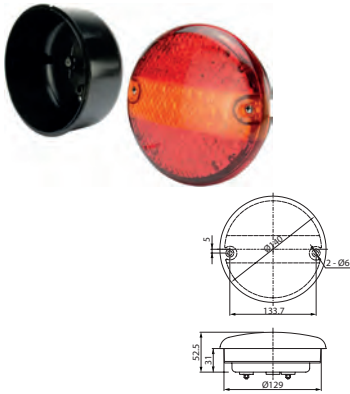
Mounting kit: HC-CARGO 171266.

Voltage: 9-33

Dim.: 140x60 mm
Dist. mount. holes: 45 mm

Type: LED Multifunction Lamp
Connection: Terminal
Colour: Black
Material: Shockproof plastic
Shape: Round
Fixing screw: 2
Flasher light: w/
Numberplate light: w/o
Rear/fog lamp: w/o
Reverse light: w/o
Sidemarkers: w/o
Sidemarkers lamp: w/o
Tail light: w/
Stop light: w/
No./LEDs: 63
E-approval: Yes

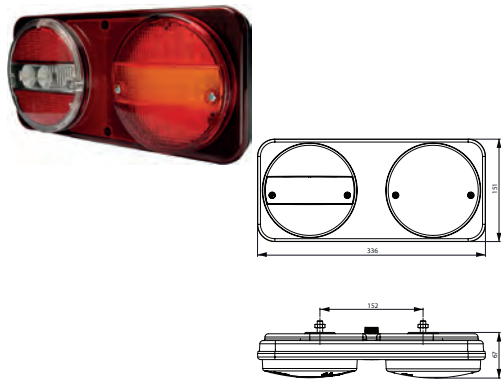
171665 LED Multifunction Lamp Std pkg 1

Right: HC-CARGO 171666.

Voltage: 12/24

Dim.: 336x151x67 mm
Dist. mount. holes: 152 mm

Type: LED Multifunction Lamp
Connection: Terminal
Material: Shockproof plastic
Shape: Rectangular
Reflector: w/
Flasher light: w/
Numberplate light: w/o
Rear/fog lamp: w/o
Reverse light: w/
Sidemarkers: w/o
Sidemarkers lamp: w/o
Tail light: w/
Stop light: w/
RH/LH: LH
E-approval: Yes

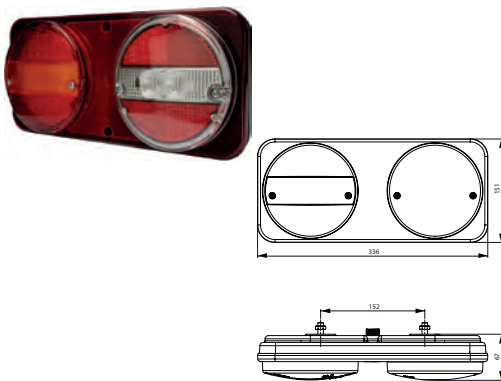
171666 LED Multifunction Lamp Std pkg 1

Left: HC-CARGO 171665.

Voltage: 12/24

Dim.: 336x151x67 mm
Dist. mount. holes: 152 mm

Type: LED Multifunction Lamp
Connection: Terminal
Material: Shockproof plastic
Shape: Rectangular
Reflector: w/
Flasher light: w/
Numberplate light: w/o
Rear/fog lamp: w/o
Reverse light: w/
Sidemarkers: w/o
Sidemarkers lamp: w/o
Tail light: w/
Stop light: w/
RH/LH: RH
E-approval: Yes

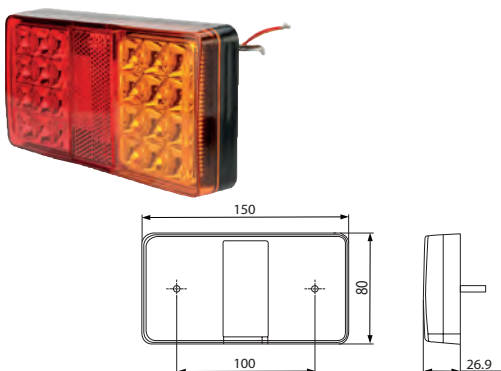
171667 LED Multifunction Lamp Std pkg 1

White = ground. Brown = tail light. Red = stop. Yellow = indicator.

Voltage: 12/24

Dim.: 150x80x26.9 mm
Dist. mount. holes: 100 mm

Type: LED Multifunction Lamp
Connection: Cable
Material: Plastic
Shape: Rectangular
Reflector: w/
Flasher light: w/
Numberplate light: w/o
Rear/fog lamp: w/o
Reverse light: w/o
Sidemarkers: w/o
Sidemarkers lamp: w/o
Tail light: w/
Stop light: w/
No./LEDs: 24
Tightness norm: IP 67
E-approval: Yes

171668 LED Multifunction Lamp Std pkg 1

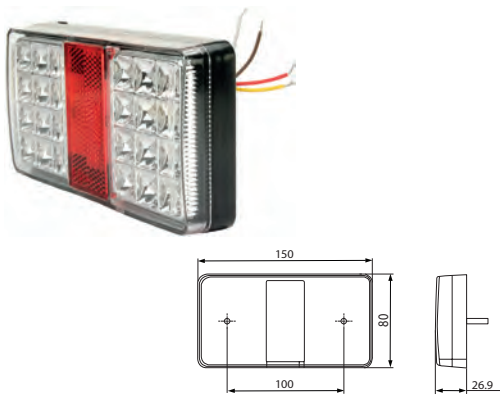
White = ground. Brown = tail light. Red = stop. Yellow = indicator.



Voltage: 12/24

Dim.: 150x80x26.9 mm
Dist. mount. holes:
100 mm

Type: LED Multifunction Lamp
Connection: Cable
Colour/glass: Transparent
Material: Shockproof plastic
Material/dome: Glass
Shape: Rectangular
Reflector: w/
Flasher light: w/
Numberplate light: w/o
Rear/fog lamp: w/o
Reverse light: w/o
Sidemarker: w/o
Sidemarker lamp: w/o
Tail light: w/
Stop light: w/
No./LEDs: 24
Tightness norm: IP 67
E-approval: Yes

171756 LED Multifunction Lamp Std pkg 1

Multi-plug: HC-CARGO 171788, 172066. Right: HC-CARGO 171757.

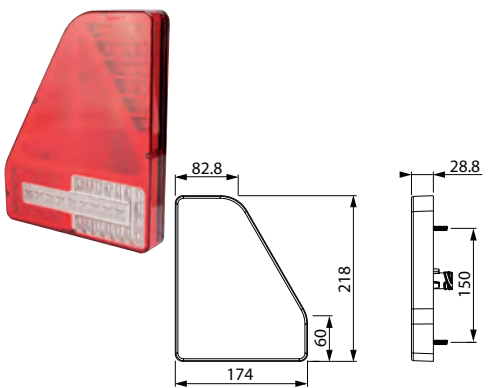

Voltage: 12/24

Dim.: 174x218x28.8 mm
Dist. mount. holes:
150 mm

Type: LED Tail/position lamp
Connection: Multiplug
Material: Shockproof plastic
Material/dome: Shockproof plastic
Shape: Triangle
Reflector: w/
Flasher light: w/
Numberplate light: w/o
Rear/fog lamp: w/
Reverse light: w/
Sidemarker: w/o
Sidemarker lamp: w/o
Tail light: w/
Stop light: w/
RH/LH: RH
Tightness norm: IP 67
E-approval: Yes

171757 LED Multifunction Lamp Std pkg 1

Multi-plug: HC-CARGO 171788, 172066. Left: HC-CARGO 171756.

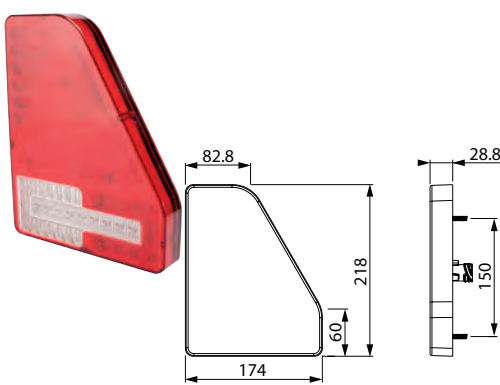

Voltage: 12/24

Dim.: 174x218x28.8 mm
Dist. mount. holes:
150 mm

Type: LED Tail/position lamp
Connection: Multiplug
Material: Shockproof plastic
Material/dome: Shockproof plastic
Shape: Triangle
Reflector: w/
Flasher light: w/
Numberplate light: w/o
Rear/fog lamp: w/
Reverse light: w/
Sidemarker: w/o
Sidemarker lamp: w/o
Tail light: w/
Stop light: w/
RH/LH: LH
Tightness norm: IP 67
E-approval: Yes

171758 LED Multifunction Lamp Std pkg 1

White = ground. Red = stop. Black = tail. Yellow = indicator. Brown = reverse. Left: HC-CARGO 171759.

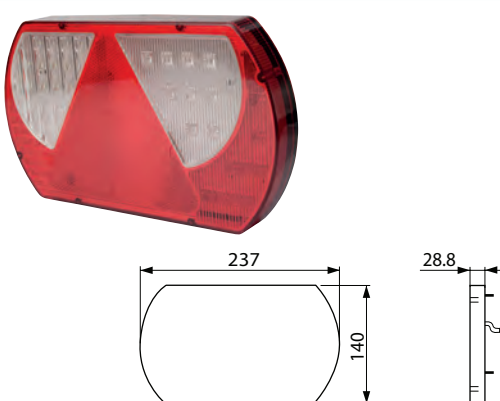

Voltage: 12/24

Dim.: 237x140x28.8 mm
Cable length: 2000 mm
Dist. mount. holes:
152 mm

Type: LED Tail lamp
Connection: Cable
Material: Shockproof plastic
Material/dome: Shockproof plastic
Shape: Oval
Mount.: 2 screws
Reflector: w/
Flasher light: w/
Numberplate light: w/
Rear/fog lamp: w/o
Reverse light: w/
Sidemarker: w/o
Sidemarker lamp: w/o
Tail light: w/
Stop light: w/
RH/LH: RH
Tightness norm: IP 66
E-approval: Yes

171759 LED Multifunction Lamp Std pkg 1

White=ground. Brown=tail. Yellow=flasher. Red=stop. Right: HC-CARGO 171758.

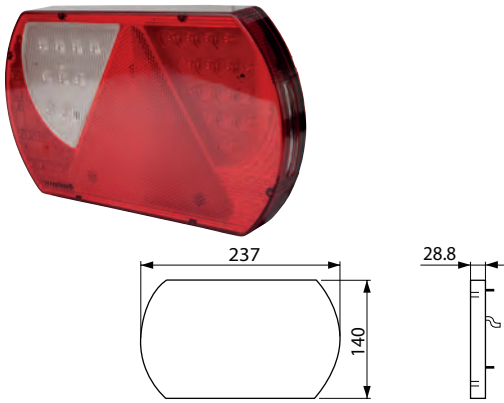

Voltage: 12/24

Dim.: 237x140x28.8 mm
Cable length: 2000 mm
Dist. mount. holes: 152 mm

Type: LED Tail lamp
Connection: Cable
Material: Shockproof plastic
Material/dome: Shockproof plastic
Shape: Oval
Mount.: 2 screws
Reflector: w/
Flasher light: w/
Numberplate light: w/
Rear/fog lamp: w/
Reverse light: w/o
Sidemarker: w/o
Sidemarker lamp: w/o
Tail light: w/
Stop light: w/
RH/LH: LH
Tightness norm: IP 66
E-approval: Yes

171772 LED Multifunction Lamp Std pkg 1

White=ground. Brown=tail. Yellow=flasher. Red=stop.

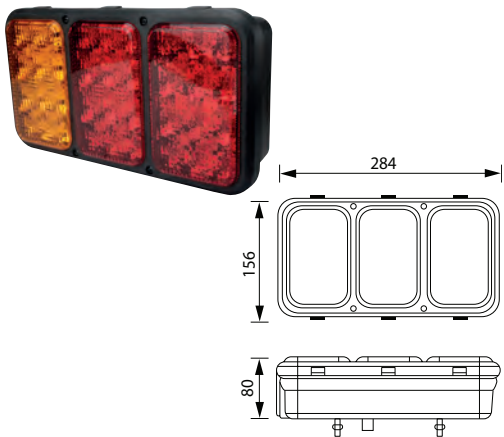

Voltage: 24

Dim.: 284x156x102 mm
Dist. mount. holes: 130x78 mm

Type: LED Tail lamp
Connection: Cable
Material: Polypropylene
Material/dome: PMMA
Shape: Rectangular
Mount.: 4 screws
Reflector: w/
Flasher light: w/
Numberplate light: w/o
Rear/fog lamp: w/o
Reverse light: w/o
Sidemarker: w/o
Sidemarker lamp: w/o
Tail light: w/
Stop light: w/
No./LEDs: 3x16
RH/LH: RH/LH
Tightness norm: IP 67
E-approval: Yes

171789 LED Multifunction Lamp Std pkg 1

Vertical mount.

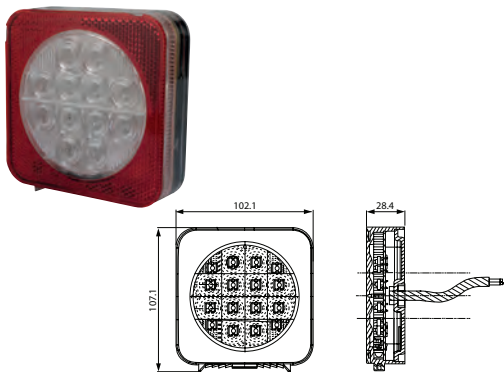

Voltage: 12/24

Dim.: 102.1x107.1x28.4 mm
Cable length: 500 mm
Dist. mount. holes: 45 mm

Type: LED Tail lamp
Connection: Cable
Material: Polycarbonate
Material/dome: Polycarbonate
Shape: Square
Mount.: 2 screws
Reflector: w/
Flasher light: w/
Numberplate light: w/
Tail light: w/
Stop light: w/
No./LEDs: 12
RH/LH: RH/LH
Tightness norm: IP 67
E-approval: Yes

171790 LED Multifunction Lamp Std pkg 1

Vertical mount.

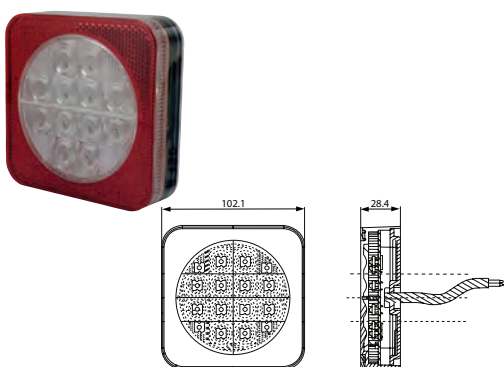

Voltage: 12/24

Dim.: 102.1x28.4 mm
Cable length: 500 mm
Dist. mount. holes: 45 mm

Type: LED Tail lamp
Connection: Cable
Material: Polycarbonate
Material/dome: Polycarbonate
Shape: Square
Mount.: 2 screws
Reflector: w/
Flasher light: w/
Numberplate light: w/o
Tail light: w/
Stop light: w/
No./LEDs: 12
RH/LH: RH/LH
Tightness norm: IP 67
E-approval: Yes

171791 LED Multifunction Lamp Std pkg 1					
<i>Horizontal mount.</i>					
		<p>Voltage: 12/24</p>		<p>Dim.: 103x101.7x28.4 mm Cable length: 500 mm Dist. mount. holes: 45 mm</p>	
<p>Type: LED Tail lamp Connection: Cable Material: Polycarbonate Material/dome: Polycarbonate Shape: Square Mount.: 2 screws Reflector: w/ Flasher light: w/ Numberplate light: w/ Tail light: w/ Stop light: w/ No./LEDs: 12 RH/LH: RH/LH Tightness norm: IP 67 E-approval: Yes</p>					
171927 LED Multifunction Lamp Std pkg 1					
<i>Multi-plug: HC-CARGO 171788, 172066. Left: HC-CARGO 171928.</i>					
		<p>Voltage: 12-24</p>		<p>Dim.: 385x150x34.1 mm Dist. mount. holes: 152.3 mm</p>	
<p>Type: LED Multifunction Lamp Connection: Multiplug Shape: Rectangular Reflector: w/ Flasher light: w/ Numberplate light: w/o Rear/fog lamp: w/ Reverse light: w/ Sidemarker: w/o Sidemarker lamp: w/o Tail light: w/ Stop light: w/ RH/LH: RH Tightness norm: IP 67 E-approval: Yes</p>					
171928 LED Multifunction Lamp Std pkg 1					
<i>Multi-plug: HC-CARGO 171788, 172066. Right: HC-CARGO 171927.</i>					
		<p>Voltage: 12-24</p>		<p>Dim.: 385x150x34.1 mm Dist. mount. holes: 152 mm</p>	
<p>Type: LED Multifunction Lamp Connection: Multiplug Shape: Rectangular Reflector: w/ Flasher light: w/ Numberplate light: w/o Rear/fog lamp: w/ Reverse light: w/ Sidemarker: w/o Sidemarker lamp: w/o Tail light: w/ Stop light: w/ RH/LH: LH Tightness norm: IP 67 E-approval: Yes</p>					
171929 LED Multifunction Lamp Std pkg 1					
<i>Multi-plug: HC-CARGO 171788, 172066. Left: HC-CARGO 171930.</i>					
		<p>Voltage: 12-24</p>		<p>Dim.: 240.3x140x31 mm Dist. mount. holes: 152 mm</p>	
<p>Type: LED Multifunction Lamp Connection: Multiplug Shape: Rectangular Reflector: w/ Flasher light: w/ Numberplate light: w/o Rear/fog lamp: w/ Reverse light: w/ Sidemarker: w/o Sidemarker lamp: w/o Tail light: w/ Stop light: w/ RH/LH: RH Tightness norm: IP 67 E-approval: Yes</p>					
171930 LED Multifunction Lamp Std pkg 1					
<i>Multi-plug: HC-CARGO 171788, 172066. Right: HC-CARGO 171929.</i>					
		<p>Voltage: 12-24</p>		<p>Dim.: 240.3x140x31 mm Dist. mount. holes: 152 mm</p>	
<p>Type: LED Multifunction Lamp Connection: Multiplug Shape: Rectangular Reflector: w/ Flasher light: w/ Numberplate light: w/o Rear/fog lamp: w/ Reverse light: w/ Sidemarker: w/o Sidemarker lamp: w/o Tail light: w/ Stop light: w/ RH/LH: LH Tightness norm: IP 67 E-approval: Yes</p>					

171952 LED Multifunction Lamp Std pkg 1

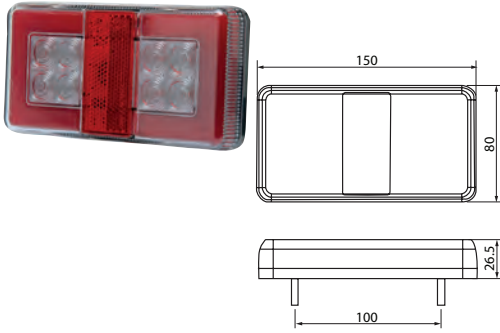

Voltage: 12-24

Dim.: 150x80x26.5 mm
Cable length: 300 mm
Dist. mount. holes: 100 mm

Type: LED Multifunction Lamp
Connection: Cable
Shape: Rectangular
Mount.: 2 screws
Reflector: w/
No./reflectors: 1
Flasher light: w/
Numberplate light: w/o
Rear/fog lamp: w/o
Reverse light: w/o
Sidemarker: w/o
Sidemarker lamp: w/o
Tail light: w/
Stop light: w/
Tightness norm: IP 67
Approval: CE
E-approval: Yes

172061 LED Multifunction Lamp Std pkg 1

Lens: HC-CARGO 172065. Plug: HC-CARGO 171788, 172066. Left: HC-CARGO 172062.



Voltage: 12-24

Dim.: 426.3x155.2x111.6 mm
Dist. mount. holes: 152 mm

Type: LED
Material: PP
Material/dome: Polycarbonate
Shape: Rectangular
Reflector: w/
Flasher light: w/
Numberplate light: w/o
Rear/fog lamp: w/
Reverse light: w/
Sidemarker: w/o
Sidemarker lamp: w/
Tail light: w/
Stop light: w/
RH/LH: RH
E-approval: Yes

172062 LED Multifunction Lamp Std pkg 1

Lens: HC-CARGO 172065. Plug: HC-CARGO 171788, 172066. Right: HC-CARGO 172061.

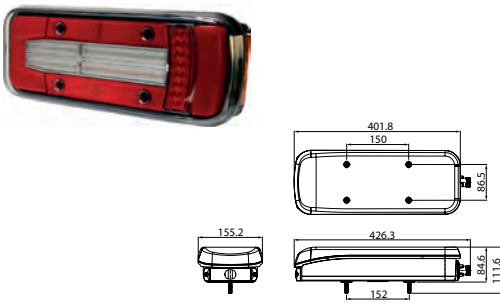

Voltage: 12-24

Dim.: 426.3x155.2x111.6 mm
Dist. mount. holes: 152 mm

Type: LED
Material: PP
Material/dome: Polycarbonate
Shape: Rectangular
Reflector: w/
Flasher light: w/
Numberplate light: w/o
Rear/fog lamp: w/
Reverse light: w/
Sidemarker: w/o
Sidemarker lamp: w/
Tail light: w/
Stop light: w/
RH/LH: LH
E-approval: Yes

172063 LED Multifunction Lamp Std pkg 1

Lens: HC-CARGO 172067. Plug: HC-CARGO 171788, 172066. Left: HC-CARGO 172064.

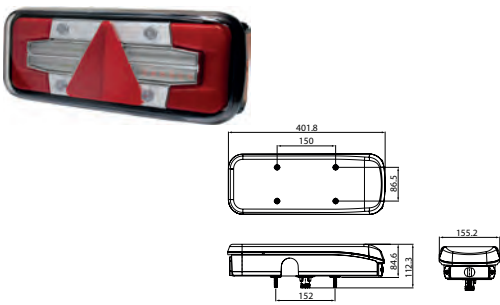

Voltage: 12-24

Dim.: 401.8x155.2x112.3 mm
Dist. mount. holes: 152 mm

Type: LED
Material: PP
Material/dome: Polycarbonate
Shape: Rectangular
Reflector: w/
Flasher light: w/
Numberplate light: w/o
Rear/fog lamp: w/
Reverse light: w/
Sidemarker: w/o
Sidemarker lamp: w/
Tail light: w/
Stop light: w/
RH/LH: RH
E-approval: Yes

172064 LED Multifunction Lamp Std pkg 1

Lens: HC-CARGO 172067. Plug: HC-CARGO 171788, 172066. Right: HC-CARGO 172063.

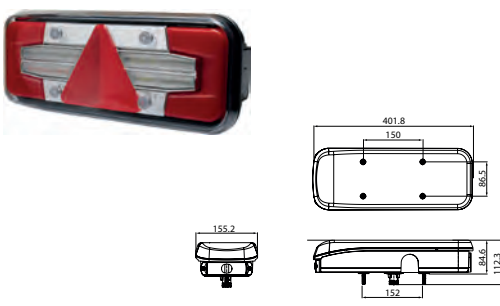

Voltage: 12-24

Dim.: 401.8x155.2x112.3 mm
Dist. mount. holes: 152 mm

Type: LED
Material: PP
Material/dome: Polycarbonate
Shape: Rectangular
Reflector: w/
Flasher light: w/
Numberplate light: w/o
Rear/fog lamp: w/
Reverse light: w/
Sidemarker: w/o
Sidemarker lamp: w/
Tail light: w/
Stop light: w/
RH/LH: LH
E-approval: Yes

172149 LED Multifunction Lamp Std pkg 1

Right: HC-CARGO 172151.

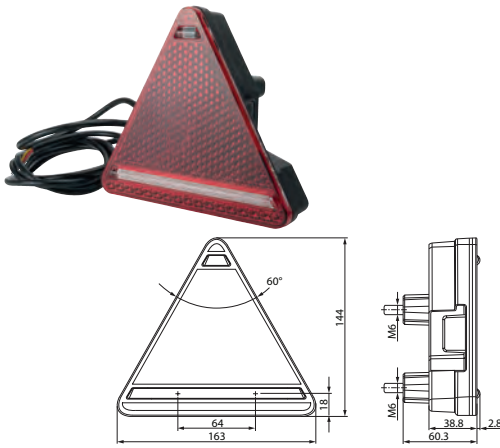

Voltage: 12/24

Dim.: 163x144 mm
Cable length: 1850 mm
Dist. mount. holes:
64 mm

Type: LED Tail lamp
Connection: Cable
Colour: Black
Colour/glass: Red
Material: PP
Material/dome: PMMA
Shape: Triangle
Mount.: Horizontal
Reflector: w/
Fixing screw: 2
Flasher light: w/
Numberplate light: w/
Rear/fog lamp: w/o
Reverse light: w/o
Sidemarker lamp: w/o
Tail light: w/
Stop light: w/
LEDs: w/
RH/LH: LH
Tightness norm: IP 66/68
E-approval: Yes

172150 LED Multifunction Lamp Std pkg 1

Right: HC-CARGO 172152.

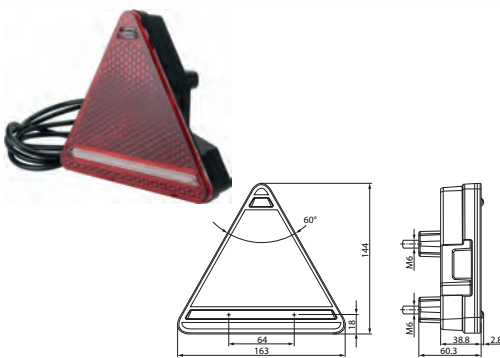

Voltage: 12-24

Dim.: 163x144 mm
Cable length: 1850 mm
Dist. mount. holes:
64 mm

Type: LED Tail lamp
Connection: Cable
Colour: Black
Colour/glass: Red
Material: PP
Material/dome: PMMA
Shape: Triangle
Mount.: Horizontal
Reflector: w/
Fixing screw: 2
Flasher light: w/
Tail light: w/
Stop light: w/
LEDs: w/
RH/LH: LH
Tightness norm: IP 66/68
E-approval: Yes

172151 LED Multifunction Lamp Std pkg 1

Left: HC-CARGO 172149.

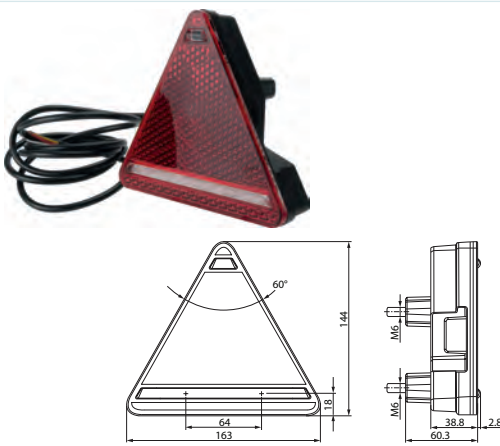

Voltage: 12-24

Dim.: 163x144 mm
Cable length: 1850 mm
Dist. mount. holes:
64 mm

Type: LED Tail lamp
Connection: Cable
Colour: Black
Colour/glass: Red
Material: PP
Material/dome: PMMA
Shape: Triangle
Mount.: Horizontal
Reflector: w/
Fixing screw: 2
Flasher light: w/
Numberplate light: w/
Rear/fog lamp: w/o
Reverse light: w/o
Sidemarker lamp: w/o
Tail light: w/
Stop light: w/
LEDs: w/
RH/LH: RH
Tightness norm: IP 66/68
E-approval: Yes

172152 LED Multifunction Lamp Std pkg 1

Left: HC-CARGO 172150.

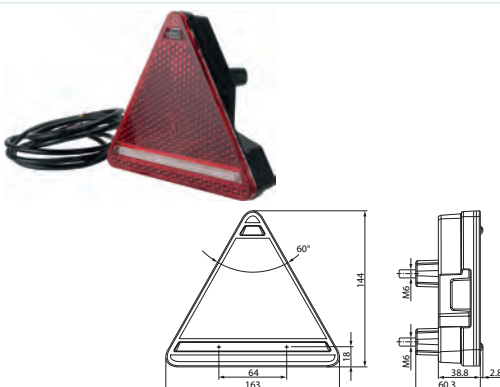

Voltage: 12-24

Dim.: 163x144 mm
Cable length: 1850 mm
Dist. mount. holes:
64 mm

Type: LED Tail lamp
Connection: Cable
Colour: Black
Colour/glass: Red
Material: PP
Material/dome: PMMA
Shape: Triangle
Mount.: Horizontal
Reflector: w/
Fixing screw: 2
Flasher light: w/
Tail light: w/
Stop light: w/
LEDs: w/
RH/LH: RH
Tightness norm: IP 66/68
E-approval: Yes

172214 LED Multifunction Lamp Std pkg 1

w/ built-in resistor.

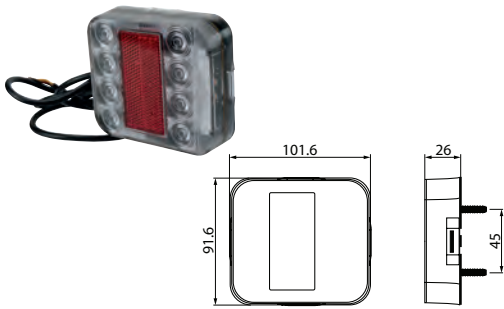

Voltage: 12

Dim.:
101.6x91.6x26 mm
Cable length: 500 mm
Dist. mount. holes:
45 mm

Type: LED Multifunction Lamp
Connection: Cable
Shape: Square
Mount.: 4 holes
Reflector: w/
Flasher light: w/
Numberplate light: w/
Tail light: w/
Stop light: w/
LEDs: w/
RH/LH: RH/LH
Tightness norm: IP 67
E-approval: Yes
Alternativ no.: 172218

172215 LED Multifunction Lamp Std pkg 1

w/ built-in resistor.

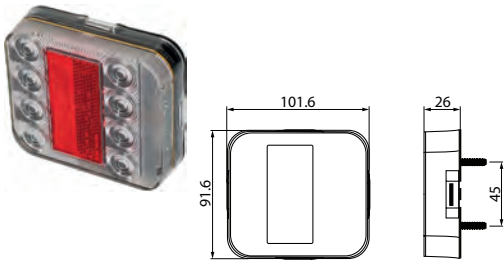

Voltage: 12

Dim.:
101.6x91.6x26 mm
Cable length: 500 mm
Dist. mount. holes:
45 mm

Type: LED Multifunction Lamp
Connection: Cable
Shape: Square
Mount.: 4 holes
Reflector: w/
Flasher light: w/
Tail light: w/
Stop light: w/
LEDs: w/
RH/LH: RH/LH
Tightness norm: IP 67
E-approval: Yes

172218 LED Multifunction Lamp Std pkg 1

w/ built-in resistor.

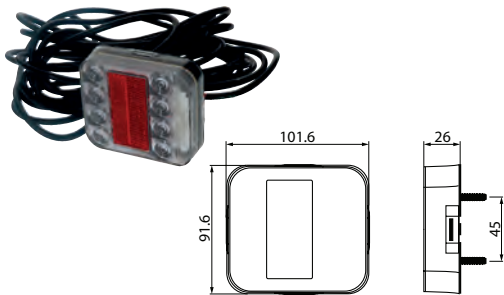

Voltage: 12

Dim.:
101.6x91.6x26 mm
Cable length: 7500 mm
Dist. mount. holes:
45 mm

Type: LED Multifunction Lamp
Connection: Cable
Shape: Square
Mount.: 4 holes
Reflector: w/
Flasher light: w/
Numberplate light: w/
Tail light: w/
Stop light: w/
LEDs: w/
RH/LH: RH/LH
Tightness norm: IP 67
E-approval: Yes
Alternativ no.: 172214

SPARE PARTS

172065 Lens, Rear Lamp Std pkg 1 Servicing: HC-CARGO 172061, 172062



Dim.: 401.8x155.2 mm

Material/dome: Polycarbonate
RH/LH: RH/LH

172067 Lens, Rear Lamp Std pkg 1 Servicing: HC-CARGO 172063, 172064



Dim.: 401.8x155.2 mm

Material/dome: Polycarbonate
RH/LH: RH/LH

ACCESSORIES

160970 Load Resistor 12 V Std pkg 1

Contains: 2 pcs.



Voltage: 12
Amp: 2
Watt: 50

Length: 50 mm
Width: 15 mm

160971 Load Resistor 24 V Std pkg 1

Contains: 2 pcs.



Voltage: 24	Length: 50 mm
Amp: 1	Width: 15 mm
Watt: 50	

TRAILER LAMPS CONVENTIONAL (TRUCKS)

170602 Multi Function Lamp Std pkg 1 Servicing: RVI Renault, Pegaso - Visit our web catalogue for further information

Lens: HC-CARGO 170665. Right: HC-CARGO 170603. Vibration Damper: HC-CARGO 170604.

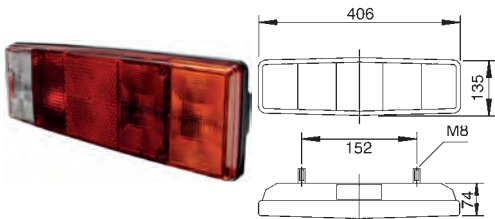

Bulb incl.: No	Dim.: 406x135x74 mm
Watt: 21	Dist. mount. holes: 152 mm
Watt 2: 5	
Watt 3: 10	

Socket type: BA15S
Socket type 2: BA15S
Socket type 3: BA15S
Material: Shockproof plastic
Shape: Rectangular
Reflector: w/
Flasher light: w/
Numberplate light: w/
Rear/fog lamp: w/
Reverse light: w/
Sidemarkers: w/o
Sidemarkers lamp: w/o
Tail light: w/
Stop light: w/
RH/LH: LH
E-approval: Yes

170603 Multi Function Lamp Std pkg 1 Servicing: RVI Renault, Pegaso - Visit our web catalogue for further information

Lens: HC-CARGO 170665. Left: HC-CARGO 170602. Vibration Damper: HC-CARGO 170604.

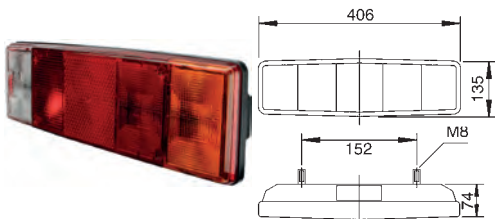

Bulb incl.: No	Dim.: 406x135x74 mm
Watt: 21	Dist. mount. holes: 152 mm
Watt 2: 5	
Watt 3: 10	

Socket type: BA15S
Socket type 2: BA15S
Socket type 3: BA15S
Material: Shockproof plastic
Shape: Rectangular
Reflector: w/
Flasher light: w/
Numberplate light: w/o
Rear/fog lamp: w/
Reverse light: w/
Sidemarkers: w/o
Sidemarkers lamp: w/o
Tail light: w/
Stop light: w/
RH/LH: RH
E-approval: Yes

170893 Multi Function Lamp Std pkg 1

Lens: HC-CARGO 171062. Left: HC-CARGO 170895. 2 bulb holders for tail light.

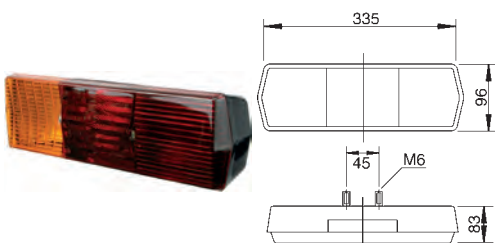

Bulb incl.: No	Dim.: 335x96x83 mm
Watt: 21	Dist. mount. holes: 45 mm

Socket type: BA15S
Material: Shockproof plastic
Shape: Rectangular
Flasher light: w/
Numberplate light: w/o
Rear/fog lamp: w/o
Reverse light: w/o
Sidemarkers: w/o
Sidemarkers lamp: w/o
Tail light: w/
Stop light: w/
RH/LH: RH

170895 Multi Function Lamp Std pkg 1

Lens: HC-CARGO 171062. Right: HC-CARGO 170893. 2 bulb holders for tail light.

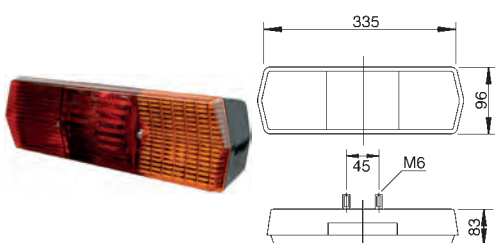

Bulb incl.: No	Dim.: 335x96x83 mm
Watt: 21	Dist. mount. holes: 45 mm

Socket type: BA15S
Material: Shockproof plastic
Shape: Rectangular
Flasher light: w/
Numberplate light: w/o
Rear/fog lamp: w/o
Reverse light: w/o
Sidemarkers: w/o
Sidemarkers lamp: w/o
Tail light: w/
Stop light: w/
RH/LH: LH

170916 Multi Function Lamp Std pkg 1 Servicing: Scania, Universal - Visit our web catalogue for further information

Lens: HC-CARGO 170968. Right: HC-CARGO 170917. 2 bulb holders for tail light.

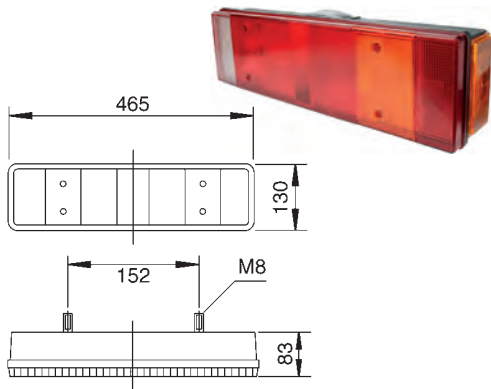

Bulb incl.: No
Watt: 21
Watt 2: 5
Watt 3: 10

Dim.: 465x130x83 mm
Dist. mount. holes:
152 mm

Socket type: BA15S
Socket type 2: BA15S
Socket type 3: BA15S
Material: Shockproof plastic
Shape: Rectangular
Reflector: w/
Flasher light: w/
Numberplate light: w/
Rear/fog lamp: w/
Reverse light: w/
Sidemarker: w/o
Sidemarker lamp: w/
Tail light: w/
Stop light: w/
RH/LH: LH

170917 Multi Function Lamp Std pkg 1 Servicing: Scania, Universal - Visit our web catalogue for further information

Lens: HC-CARGO 170968. Left: HC-CARGO 170916. 2 bulb holders for tail light.

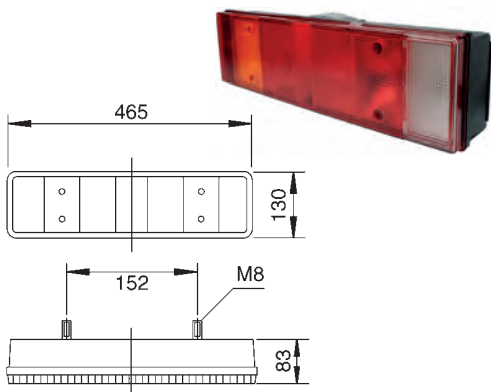

Bulb incl.: No
Watt: 21
Watt 2: 5
Watt 3: 10

Dim.: 465x130x83 mm
Dist. mount. holes:
152 mm

Socket type: BA15S
Socket type 2: BA15S
Socket type 3: BA15S
Material: Shockproof plastic
Shape: Rectangular
Reflector: w/
Flasher light: w/
Numberplate light: w/
Rear/fog lamp: w/
Reverse light: w/
Sidemarker: w/o
Sidemarker lamp: w/
Tail light: w/
Stop light: w/
RH/LH: RH
E-approval: Yes

170922 Multi Function Lamp Std pkg 1 Servicing: MAN, Universal - Visit our web catalogue for further information

Lens: HC-CARGO 170968. Right: HC-CARGO 170923.

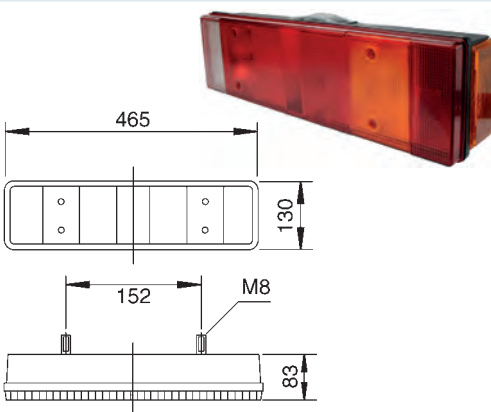

Bulb incl.: No
Watt: 21
Watt 2: 5
Watt 3: 10

Dim.: 465x130x83 mm
Dist. mount. holes:
152 mm

Socket type: BA15S
Socket type 2: BA15S
Socket type 3: BA15S
Material: Shockproof plastic
Shape: Rectangular
Reflector: w/
Flasher light: w/
Numberplate light: w/
Rear/fog lamp: w/
Reverse light: w/o
Sidemarker: w/o
Sidemarker lamp: w/
Tail light: w/
Stop light: w/
RH/LH: LH
E-approval: Yes

170923 Multi Function Lamp Std pkg 1 Servicing: MAN, Universal - Visit our web catalogue for further information

Lens: HC-CARGO 170968. Left: HC-CARGO 170922. 2 bulb holders for tail light.

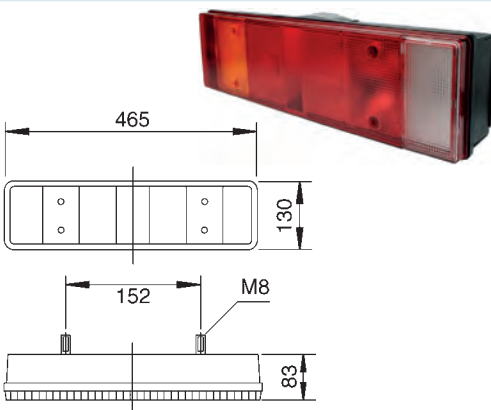

Bulb incl.: No
Watt: 21
Watt 2: 5
Watt 3: 10

Dim.: 465x130x83 mm
Dist. mount. holes:
152 mm

Socket type: BA15S
Socket type 2: BA15S
Socket type 3: BA15S
Material: Shockproof plastic
Shape: Rectangular
Reflector: w/
Flasher light: w/
Numberplate light: w/
Rear/fog lamp: w/
Reverse light: w/
Sidemarker: w/o
Sidemarker lamp: w/
Tail light: w/
Stop light: w/
RH/LH: RH
E-approval: Yes

170990 Multi Function Lamp Std pkg 1 Servicing: Commercial trailers - Visit our web catalogue for further information

Left: HC-CARGO 170991.

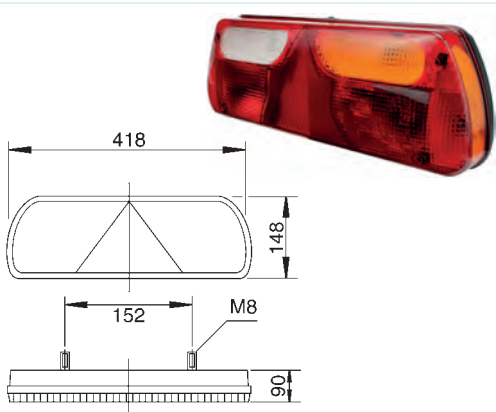

Bulb incl.: No
Watt: 21
Watt 2: 20/5
Watt 3: 5
Watt 4: 10

Dim.: 418x148x90 mm
Dist. mount. holes:
152 mm

Socket type: BA15S
Socket type 2: BAY15d
Socket type 3: BA15S
Socket type 4: BA10s
Material: Shockproof plastic
Shape: Rectangular
Reflector: w/
Flasher light: w/
Numberplate light: w/
Rear/fog lamp: w/
Reverse light: w/o
Sidemarker: w/o
Sidemarker lamp: w/
Tail light: w/
Stop light: w/
RH/LH: RH
E-approval: Yes

170991 Multi Function Lamp Std pkg 1 Servicing: Commercial trailers - Visit our web catalogue for further information

Right: HC-CARGO 170990.

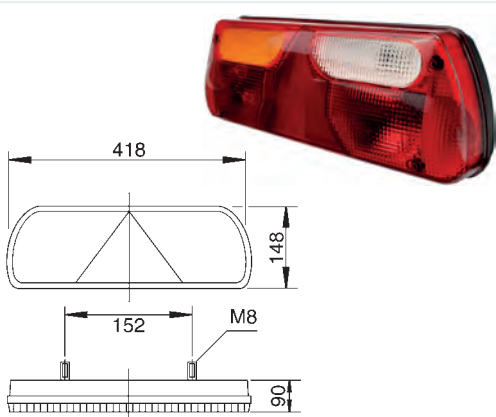

Bulb incl.: No
Watt: 21
Watt 2: 21/5
Watt 3: 5
Watt 4: 10

Dim.: 418x148x90 mm
Dist. mount. holes:
152 mm

Socket type: BA15S
Socket type 2: BAY15d
Socket type 3: BA15S
Socket type 4: BA10s
Material: Shockproof plastic
Shape: Rectangular
Reflector: w/
Flasher light: w/
Numberplate light: w/
Rear/fog lamp: w/
Reverse light: w/o
Sidemarker: w/o
Sidemarker lamp: w/
Tail light: w/
Stop light: w/
RH/LH: LH
E-approval: Yes

170998 Multi Function Lamp Std pkg 1 Servicing: Iveco - Visit our web catalogue for further information

Multi function lamp: HC-CARGO 170999. Lens: HC-CARGO 171000. 2 bulb holders for tail light.

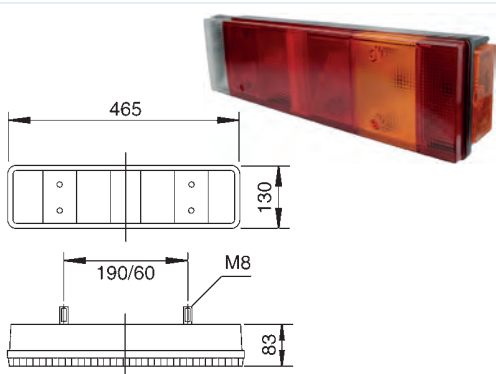

Bulb incl.: No
Watt: 21
Watt 2: 5

Dim.: 465x130x83 mm
Dist. mount. holes:
190/60 mm

Socket type: BA15S
Socket type 2: BA15S
Material: Shockproof plastic
Shape: Rectangular
Reflector: w/
Flasher light: w/
Numberplate light: w/o
Rear/fog lamp: w/
Reverse light: w/o
Sidemarker: w/o
Sidemarker lamp: w/
Tail light: w/
Stop light: w/
RH/LH: RH/LH
E-approval: Yes

170999 Multi Function Lamp Std pkg 1 Servicing: Iveco - Visit our web catalogue for further information

Multi function lamp: HC-CARGO 170998. 2 bulb holders for tail light. Lens: HC-CARGO 171000.

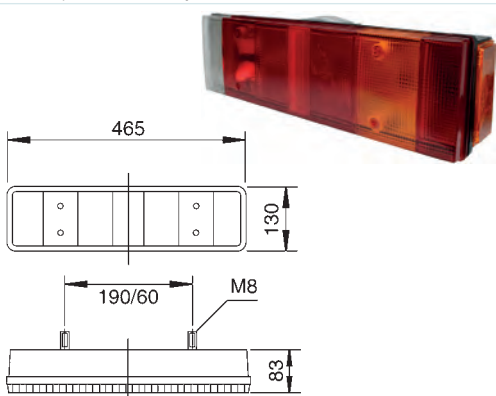

Bulb incl.: No
Watt: 21
Watt 2: 5
Watt 3: 10

Dim.: 465x130x83 mm
Dist. mount. holes:
190/60 mm

Socket type: BA15S
Socket type 2: BA15S
Socket type 3: BA15S
Material: Shockproof plastic
Shape: Rectangular
Reflector: w/
Flasher light: w/
Numberplate light: w/
Rear/fog lamp: w/
Reverse light: w/o
Sidemarker: w/o
Sidemarker lamp: w/
Tail light: w/
Stop light: w/
RH/LH: RH/LH
E-approval: Yes

171299 Multi Function Lamp Std pkg 1 Servicing: Mercedes Atego - Visit our web catalogue for further information

Lens: HC-CARGO 171307. 2 bulb holders for tail light. Left: HC-CARGO 171302.

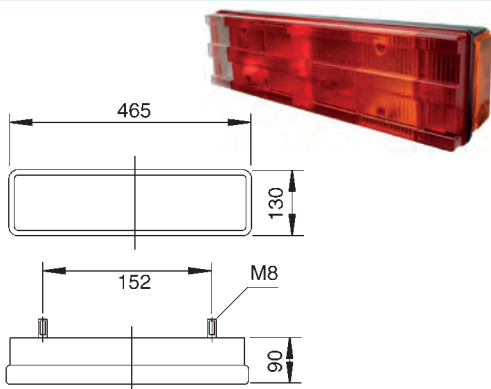

Bulb incl.: No
Watt: 21
Watt 2: 5
Watt 3: 10

Dim.: 465x130x90 mm
Dist. mount. holes:
152 mm

Socket type: BA15S
Socket type 2: BA15S
Socket type 3: BA15S
Material: Shockproof plastic
Shape: Rectangular
Reflector: w/
Flasher light: w/
Numberplate light: w/
Rear/fog lamp: w/
Reverse light: w/o
Sidemarker: w/o
Sidemarker lamp: w/
Tail light: w/
Stop light: w/
RH/LH: RH
E-approval: Yes

171302 Multi Function Lamp Std pkg 1 Servicing: Mercedes Atego - Visit our web catalogue for further information

Lens: HC-CARGO 171307. Right: HC-CARGO 171299. 2 bulb holders for tail light.

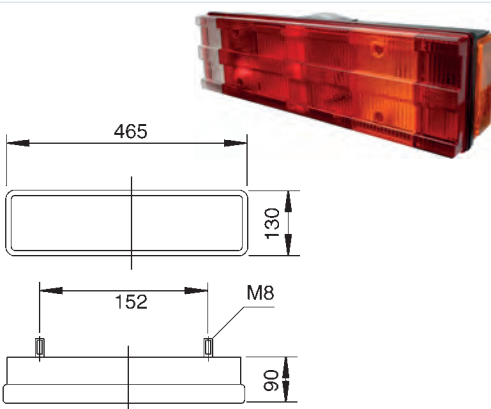

Bulb incl.: No
Watt: 21
Watt 2: 5
Watt 3: 10

Dim.: 465x130x90 mm
Dist. mount. holes:
152 mm

Socket type: BA15S
Socket type 2: BA15S
Socket type 3: BA15S
Material: Shockproof plastic
Shape: Rectangular
Reflector: w/
Flasher light: w/
Numberplate light: w/
Rear/fog lamp: w/
Reverse light: w/o
Sidemarker: w/o
Sidemarker lamp: w/
Tail light: w/
Stop light: w/
RH/LH: LH
E-approval: Yes

171303 Multi Function Lamp Std pkg 1 Servicing: Mercedes Sprinter - Visit our web catalogue for further information

Lens: HC-CARGO 171307. Left: HC-CARGO 171306. 2 bulb holders for tail light.

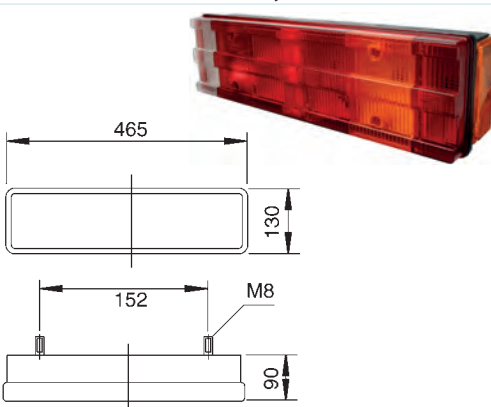

Bulb incl.: No
Watt: 21
Watt 2: 5
Watt 3: 10

Dim.: 465x130x90 mm
Dist. mount. holes:
152 mm

Socket type: BA15S
Socket type 2: BA15S
Socket type 3: BA15S
Material: Shockproof plastic
Shape: Rectangular
Reflector: w/
Flasher light: w/
Numberplate light: w/
Rear/fog lamp: w/
Reverse light: w/o
Sidemarker: w/o
Sidemarker lamp: w/
Tail light: w/
Stop light: w/
RH/LH: RH
E-approval: Yes

171306 Multi Function Lamp Std pkg 1 Servicing: Mercedes Sprinter - Visit our web catalogue for further information

Lens: HC-CARGO 171307. Right: HC-CARGO 171303. 2 bulb holders for tail light.

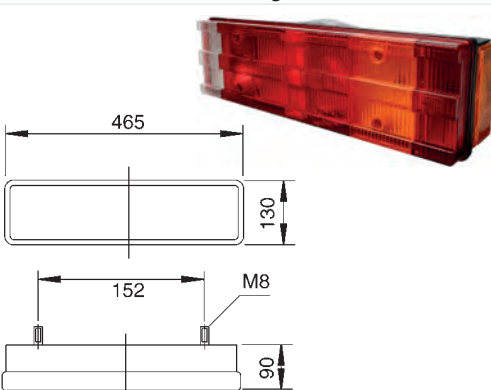

Bulb incl.: No
Watt: 21
Watt 2: 5
Watt 3: 10

Dim.: 465x130x90 mm
Dist. mount. holes:
152 mm

Socket type: BA15S
Socket type 2: BA15S
Socket type 3: BA15S
Material: Shockproof plastic
Shape: Rectangular
Reflector: w/
Flasher light: w/
Numberplate light: w/
Rear/fog lamp: w/
Reverse light: w/o
Sidemarker: w/o
Sidemarker lamp: w/
Tail light: w/
Stop light: w/
RH/LH: LH
E-approval: Yes

171308 Multi Function Lamp Std pkg 1 Servicing: Mercedes Actros - Visit our web catalogue for further information

Lens: HC-CARGO 171312. Left: HC-CARGO 171311.

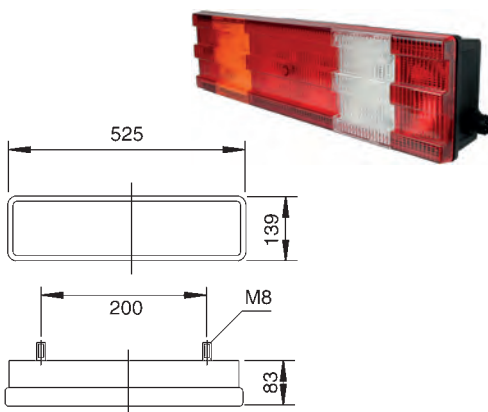

Bulb incl.: No
Watt: 21
Watt 2: 5
Watt 3: 10

Dim.: 525x139x83 mm
Dist. mount. holes:
200 mm

Socket type: BA15S
Socket type 2: BA15S
Socket type 3: BA15S
Material: Shockproof plastic
Shape: Rectangular
Reflector: w/
Fixing screw: 12
Flasher light: w/
Numberplate light: w/o
Rear/fog lamp: w/
Reverse light: w/
Sidemarker: w/o
Sidemarker lamp: w/
Tail light: w/
Stop light: w/
RH/LH: RH
E-approval: Yes

171311 Multi Function Lamp Std pkg 1 Servicing: Mercedes Actros - Visit our web catalogue for further information

Lens: HC-CARGO 171521. Right: HC-CARGO 171308.

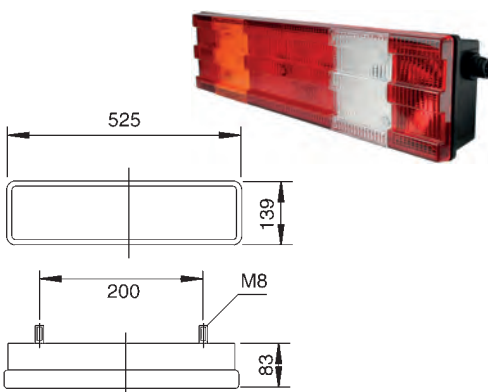

Bulb incl.: No
Watt: 21
Watt 2: 5
Watt 3: 10

Dim.: 525x139x83 mm
Dist. mount. holes:
200 mm

Socket type: BA15S
Socket type 2: BA15S
Socket type 3: BA15S
Material: Shockproof plastic
Shape: Rectangular
Reflector: w/
Flasher light: w/
Numberplate light: w/
Rear/fog lamp: w/
Reverse light: w/
Sidemarker: w/o
Sidemarker lamp: w/
Tail light: w/
Stop light: w/
RH/LH: LH
E-approval: Yes

171328 Multi Function Lamp Std pkg 1

Lens: HC-CARGO 171330.

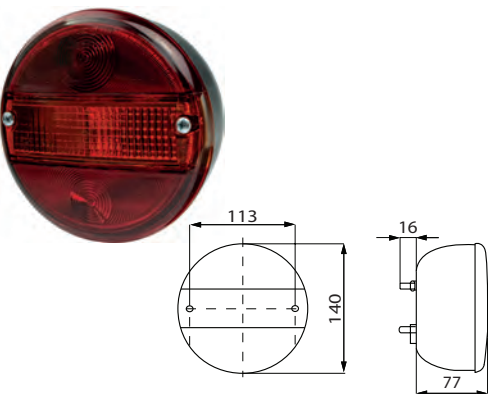

Bulb incl.: No
Watt: 21
Watt 2: 5

Dim.: 140x77 mm
OD: 140 mm
Dist. mount. holes:
45 mm

Socket type: BA15S
Socket type 2: BA15S
Connection: Terminal
Material: Shockproof plastic
Shape: Round
Fixing screw: 2
Flasher light: w/
Numberplate light: w/
Rear/fog lamp: w/o
Reverse light: w/o
Sidemarker: w/o
Sidemarker lamp: w/o
Tail light: w/
Stop light: w/
E-approval: Yes

171329 Multi Function Lamp Std pkg 1

Mounting kit: HC-CARGO 171266. Lens: HC-CARGO 171330.

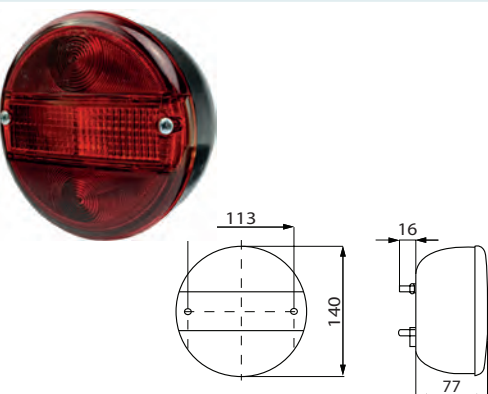

Bulb incl.: No
Watt: 21
Watt 2: 5

Dim.: 140x77 mm
OD: 140 mm
Dist. mount. holes:
45 mm

Socket type: BA15S
Socket type 2: BA15S
Connection: Terminal
Material: Shockproof plastic
Shape: Round
Fixing screw: 2
Flasher light: w/
Numberplate light: w/o
Rear/fog lamp: w/o
Reverse light: w/o
Sidemarker: w/o
Sidemarker lamp: w/o
Tail light: w/
Stop light: w/
E-approval: Yes

171441 Multi Function Lamp Std pkg 1 Servicing: Commercial trailers - Visit our web catalogue for further information

Lens: HC-CARGO 171446. Right: HC-CARGO 171442.

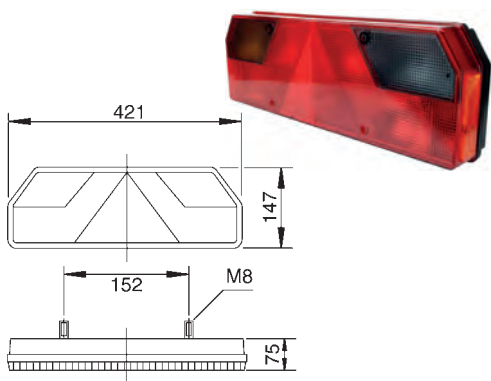

Bulb incl.: No
Watt: 21
Watt 2: 20/5
Watt 3: 10

Dim.: 421x147x75 mm
Dist. mount. holes:
152 mm

Socket type: BA15S
Socket type 2: BAY15d
Socket type 3: BA10s
Material: Shockproof plastic
Shape: Rectangular
Reflector: w/
Flasher light: w/
Numberplate light: w/
Rear/fog lamp: w/o
Reverse light: w/o
Sidemarker: w/o
Sidemarker lamp: w/o
Tail light: w/
Stop light: w/
RH/LH: LH
E-approval: Yes

171442 Multi Function Lamp Std pkg 1 Servicing: Commercial trailers - Visit our web catalogue for further information

Lens: HC-CARGO 171446. Left: HC-CARGO 171441.

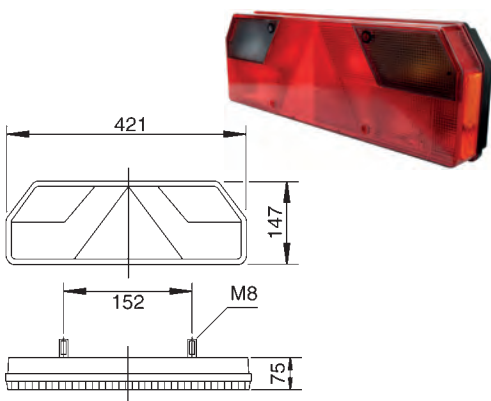

Bulb incl.: No
Watt: 21
Watt 2: 21/5
Watt 3: 5
Watt 4: 10

Dim.: 421x147x75 mm
Dist. mount. holes:
152 mm

Socket type: BA15S
Socket type 2: BAY15d
Socket type 3: BA15S
Socket type 4: BA10s
Material: Shockproof plastic
Shape: Rectangular
Reflector: w/
Flasher light: w/
Numberplate light: w/
Rear/fog lamp: w/
Reverse light: w/o
Sidemarker: w/o
Sidemarker lamp: w/
Tail light: w/
Stop light: w/
RH/LH: RH
E-approval: Yes

171443 Multi Function Lamp Std pkg 1 Servicing: Schwarzmüller - Visit our web catalogue for further information

Lens: HC-CARGO 171446. Right: HC-CARGO 171444.

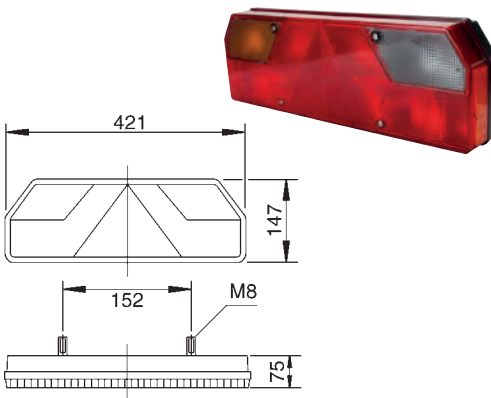

Bulb incl.: No
Watt: 21
Watt 2: 21/5
Watt 3: 5
Watt 4: 10

Dim.: 421x147x75 mm
Dist. mount. holes:
152 mm

Socket type: BA15S
Socket type 2: BAY15d
Socket type 3: BA15S
Socket type 4: BA10s
Material: Shockproof plastic
Shape: Rectangular
Reflector: w/
Flasher light: w/
Numberplate light: w/
Rear/fog lamp: w/
Reverse light: w/o
Sidemarker: w/o
Sidemarker lamp: w/
Tail light: w/
Stop light: w/
RH/LH: LH
E-approval: Yes

171444 Multi Function Lamp Std pkg 1 Servicing: Schwarzmüller - Visit our web catalogue for further information

Lens: HC-CARGO 171446. Left: HC-CARGO 171443.

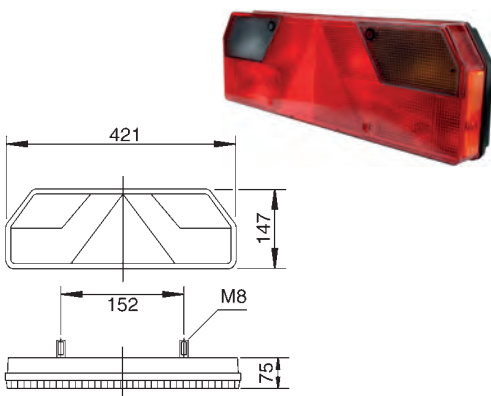

Bulb incl.: No
Watt: 21
Watt 2: 21/5
Watt 3: 5
Watt 4: 10

Dim.: 421x147x75 mm
Dist. mount. holes:
152 mm

Socket type: BA15S
Socket type 2: BAY15d
Socket type 3: BA15S
Socket type 4: BA10s
Material: Shockproof plastic
Shape: Rectangular
Reflector: w/
Flasher light: w/
Numberplate light: w/
Rear/fog lamp: w/
Reverse light: w/o
Sidemarker: w/o
Sidemarker lamp: w/
Tail light: w/
Stop light: w/
RH/LH: RH
E-approval: Yes

171447 Multi Function Lamp Std pkg 1 Servicing: Mercedes Actros SK - Visit our web catalogue for further information

Lens: HC-CARGO 171521. Right: HC-CARGO 171448.

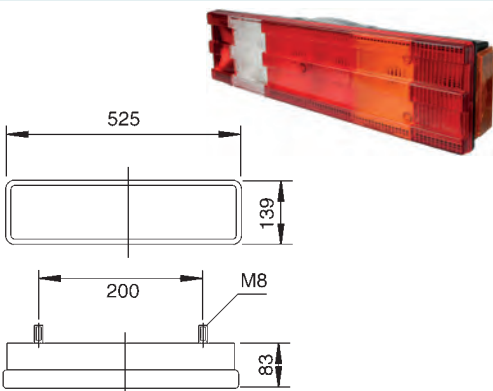

Bulb incl.: No
Watt: 21
Watt 2: 5
Watt 3: 10

Dim.: 525x139x83 mm
Dist. mount. holes:
200 mm

Socket type: BA15S
Socket type 2: BA15S
Socket type 3: BA15S
Material: Shockproof plastic
Shape: Rectangular
Reflector: w/
Flasher light: w/
Numberplate light: w/
Rear/fog lamp: w/
Reverse light: w/
Sidemarker: w/o
Sidemarker lamp: w/
Tail light: w/
Stop light: w/
RH/LH: LH
E-approval: Yes

171448 Multi Function Lamp Std pkg 1 Servicing: Mercedes Actros SK - Visit our web catalogue for further information

Lens: HC-CARGO 171312. Left: HC-CARGO 171447.

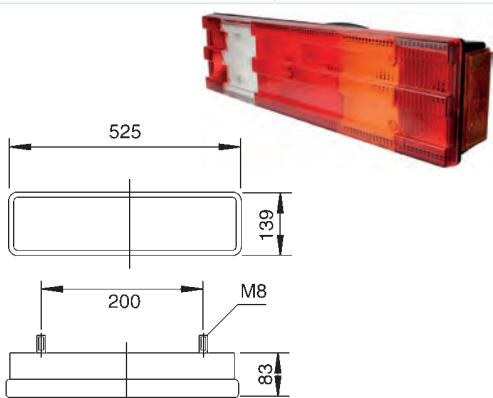

Bulb incl.: No
Watt: 21
Watt 2: 5
Watt 3: 10

Dim.: 525x139x83 mm
Dist. mount. holes:
200 mm

Socket type: BA15S
Socket type 2: BA15S
Socket type 3: BA15S
Material: Shockproof plastic
Shape: Rectangular
Reflector: w/
Flasher light: w/
Numberplate light: w/o
Rear/fog lamp: w/
Reverse light: w/
Sidemarker: w/o
Sidemarker lamp: w/
Tail light: w/
Stop light: w/
RH/LH: RH
E-approval: Yes

171506 Multi Function Lamp Std pkg 1 Servicing: DAF, Nissan, Renault - Visit our web catalogue for further information

Lens: HC-CARGO 171507. Multi Connector: HC-CARGO 171788, 172066. 2 bulb holders for tail light.

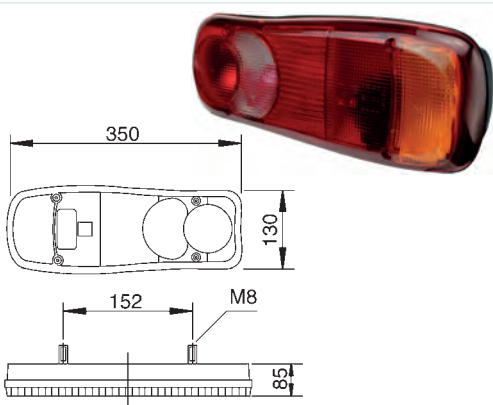

Bulb incl.: No
Watt: 21
Watt 2: 5
Watt 3: 10

Dim.: 350x130x85 mm
Dist. mount. holes:
152 mm

Socket type: BA15S
Socket type 2: BA15S
Socket type 3: BA15S
Material: Shockproof plastic
Shape: Rectangular
Reflector: w/
Flasher light: w/
Numberplate light: w/
Rear/fog lamp: w/
Reverse light: w/
Sidemarker: w/o
Sidemarker lamp: w/o
Tail light: w/
Stop light: w/
RH/LH: RH/LH
E-approval: Yes

171508 Multi Function Lamp Std pkg 1 Servicing: Commercial trailers - Visit our web catalogue for further information

Lens: HC-CARGO 171507. Optional use. 2 bulb holders for tail light.

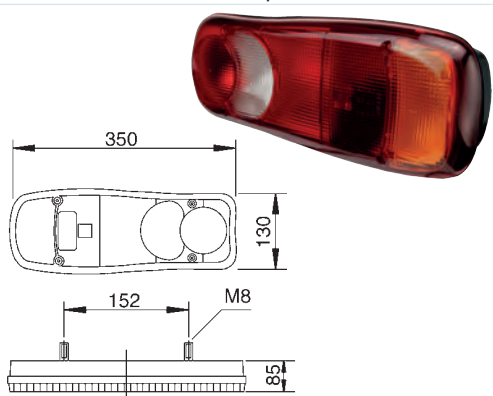

Bulb incl.: No
Watt: 21
Watt 2: 5
Watt 3: 10

Dim.: 350x130x85 mm
Dist. mount. holes:
152 mm

Socket type: BA15S
Socket type 2: BA15S
Socket type 3: BA15S
Material: Shockproof plastic
Shape: Rectangular
Flasher light: w/
Numberplate light: w/
Rear/fog lamp: w/
Reverse light: w/
Sidemarker: w/o
Sidemarker lamp: w/o
Tail light: w/
Stop light: w/
RH/LH: RH/LH
Approval: CE
E-approval: Yes

171700 Multi Function Lamp Std pkg 1

Lens: HC-CARGO 171702. Left: HC-CARGO 171701. Multi connector: HC-CARGO 171788, 172066.

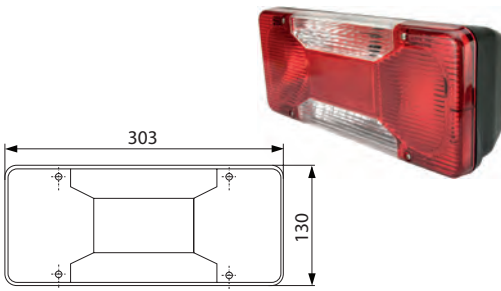

Bulb incl.: No
Voltage: 12/24

Dim.: 303x130x81 mm
Dist. mount. holes: 190 mm

Material: Shockproof plastic
Shape: Rectangular
Reflector: w/
Flasher light: w/
Numberplate light: w/o
Rear/fog lamp: w/
Reverse light: w/
Sidemarker: w/o
Sidemarker lamp: w/o
Tail light: w/
Stop light: w/
RH/LH: RH
E-approval: Yes

171701 Multi Function Lamp Std pkg 1

Lens: HC-CARGO 171702. Lens, Rear Lamp: HC-CARGO 171703. Right: HC-CARGO 171700. Multi connector: HC-CARGO 171788, 172066.

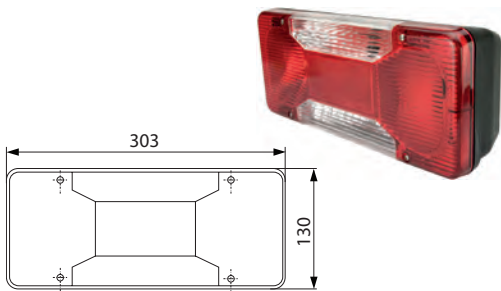

Bulb incl.: No
Voltage: 12/24

Dim.: 303x130x81 mm
Dist. mount. holes: 190 mm

Material: Shockproof plastic
Shape: Rectangular
Reflector: w/
Flasher light: w/
Numberplate light: w/o
Rear/fog lamp: w/
Reverse light: w/
Sidemarker: w/o
Sidemarker lamp: w/o
Tail light: w/
Stop light: w/
RH/LH: LH
E-approval: Yes

171802 Multi Function Lamp Std pkg 1 Servicing: Scania - Visit our web catalogue for further information

Lens: HC-CARGO 171322. Multi plug: HC-CARGO 171788, 172066. Left: HC-CARGO 171803.

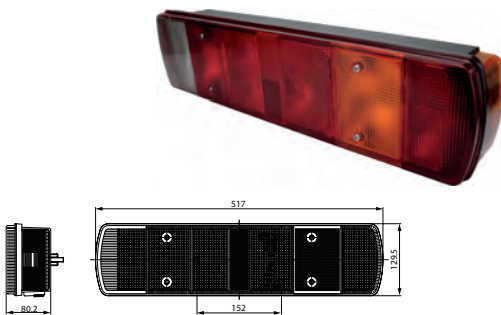

Bulb incl.: No
Watt: 21
Watt 2: 5

Dim.: 517x129.5x80.2 mm
Dist. mount. holes: 152 mm

Socket type: BA15S
Socket type 2: BA15S
Material: Shockproof plastic
Shape: Rectangular
Reflector: w/
Flasher light: w/
Numberplate light: w/
Rear/fog lamp: w/
Reverse light: w/
Sidemarker: w/o
Sidemarker lamp: w/
Tail light: w/
Stop light: w/
RH/LH: RH
E-approval: Yes

171803 Multi Function Lamp Std pkg 1 Servicing: Scania, Opel - Visit our web catalogue for further information

Lens: HC-CARGO 171322. Multi plug: HC-CARGO 171788, 172066. Right: HC-CARGO 171802.

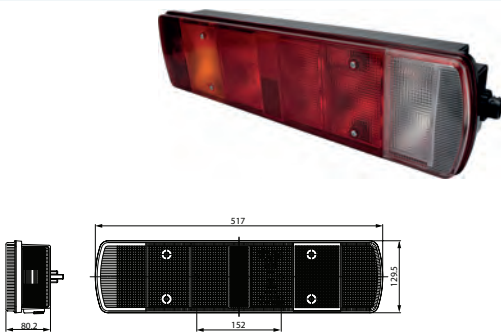

Bulb incl.: No
Watt: 21
Watt 2: 5

Dim.: 517x129.5x80.2 mm
Dist. mount. holes: 152 mm

Socket type: BA15S
Socket type 2: BA15S
Material: Shockproof plastic
Shape: Rectangular
Reflector: w/
Flasher light: w/
Numberplate light: w/
Rear/fog lamp: w/
Reverse light: w/
Sidemarker: w/o
Sidemarker lamp: w/
Tail light: w/
Stop light: w/
RH/LH: LH
E-approval: Yes

171870 Multi Function Lamp Std pkg 1 Servicing: HC-CARGO 171818, 171872



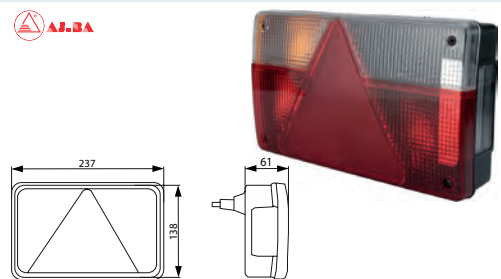

Lens: HC-CARGO 171834. Multi connector: HC-CARGO 171537, 171538. Right: HC-CARGO 171871.





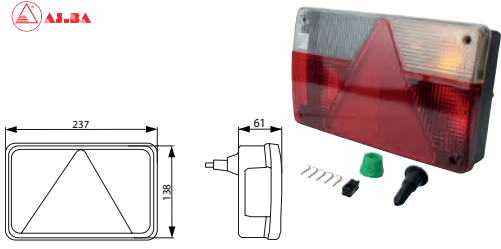



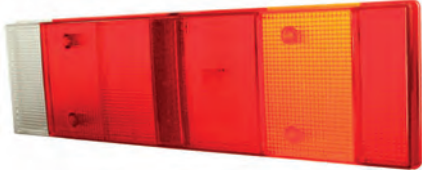

Bulb incl.: Yes
Voltage: 12

Dim.: 237x138x61 mm



Shape: Rectangular
Flasher light: w/
Numberplate light: w/
Rear/fog lamp: w/
Reverse light: w/o
Sidemarker: w/
Sidemarker lamp: w/o
Tail light: w/o
Stop light: w/
RH/LH: LH
E-approval: Yes

171871 Multi Function Lamp Std pkg 1 Servicing: HC-CARGO 171818, 171872 <i>Lens: HC-CARGO 171833. Multi connector: HC-CARGO 171537, 171538. Left: HC-CARGO 171870.</i>			
 	<p>Bulb incl.: Yes Voltage: 12</p>	<p>Dim.: 237x138x61 mm</p>	<p>Shape: Rectangular Flasher light: w/ Numberplate light: w/ Rear/fog lamp: w/ Reverse light: w/o Sidemarker: w/ Sidemarker lamp: w/o Tail light: w/o Stop light: w/ RH/LH: RH E-approval: Yes</p>
171917 Multi Function Lamp Std pkg 1			
	<p>Bulb incl.: No Watt: 5 Watt 2: 18 Watt 3: 18</p>	<p>Dim.: 115x54 mm OD: 115 mm Dist. mount. holes: 45 mm</p>	<p>Bulb type: 10.5x36 mm Bulb type 2: 15x41 mm Bulb type 3: 15x41 mm Socket type: S8.5 Socket type 2: S8.5 Socket type 3: S8.5 Connection: Terminal Colour/glass: Red/yellow Material/dome: PMMA Shape: Round Fixing screw: 2 Flasher light: w/ Numberplate light: w/o Rear/fog lamp: w/o Reverse light: w/o Sidemarker: w/o Sidemarker lamp: w/o Tail light: w/ Stop light: w/ RH/LH: RH/LH</p>
SPARE PARTS			
170665 Lens, Rear Lamp Std pkg 1 Servicing: HC-CARGO 170602, 170603			
			<p>Shape: Rectangular</p>
170910 Lens, Rear Lamp Std pkg 1 Servicing: HC-CARGO 170909			
		<p>Dim.: 140x26.8 mm Dist. mount. holes: 111 mm</p>	<p>Colour: White Shape: Round</p>
170968 Lens, Rear Lamp Std pkg 1 Servicing: HC-CARGO 170916, 170917, 170922, 170923			
		<p>Dim.: 465x130 mm</p>	<p>Shape: Rectangular</p>
171000 Lens, Rear Lamp Std pkg 1 Servicing: HC-CARGO 170998, 170999			
		<p>Dim.: 465x130x83 mm</p>	<p>Shape: Rectangular</p>

		EL. SPECIFICATIONS	DIMENSIONS	ADDITIONAL SPECIFICATIONS
171062	Lens, Rear Lamp	Std pkg 1 Servicing: HC-CARGO 170895, 170893		
			Dim.: 335x96 mm	Material: Shockproof plastic Shape: Rectangular Numberplate light: w/
171307	Lens, Rear Lamp	Std pkg 1 Servicing: HC-CARGO 171299, 171302, 171303, 171306		
			Dim.: 465x130 mm	Shape: Rectangular
171312	Lens, Rear Lamp	Std pkg 1 Servicing: HC-CARGO 171308, 171448		
			Dim.: 525x139 mm	Shape: Rectangular Reflector: w/
171322	Lens, Rear Lamp	Std pkg 1 Servicing: HC-CARGO 171802, 171803		
			Dim.: 516x130 mm Dist. mount. holes: 152 mm	Shape: Rectangular
171330	Lens, Rear Lamp	Std pkg 1 Servicing: HC-CARGO 171328, 171329		
			OD: 140 mm	Shape: Round RH/LH: RH/LH
171446	Lens, Rear Lamp	Std pkg 1 Servicing: HC-CARGO 171441, 171442, 171443, 171444		
			Dim.: 421x147 mm	Shape: Rectangular Reflector: w/ Numberplate light: w/
171507	Lens, Rear Lamp	Std pkg 1 Servicing: HC-CARGO 171506, 171508		
			Dim.: 350x130 mm	Material: Shockproof plastic Shape: Rectangular Reflector: w/ Numberplate light: w/ RH/LH: RH/LH
171521	Lens, Rear Lamp	Std pkg 1 Servicing: HC-CARGO 171311, 171447		
			Dim.: 525x139 mm	Shape: Rectangular Reflector: w/

EL. SPECIFICATIONS		DIMENSIONS	ADDITIONAL SPECIFICATIONS
171702 Lens, Rear Lamp	Std pkg 1	Servicing: HC-CARGO 171700, 171701	
		Dim.: 303x130 mm	Material: Shockproof plastic Shape: Rectangular Reflector: w/ RH/LH: RH
171703 Lens, Rear Lamp	Std pkg 1	Servicing: HC-CARGO 171701	
		Dim.: 303x130 mm	Material: Shockproof plastic Shape: Rectangular Reflector: w/ RH/LH: LH

ACCESSORIES

171788 Multiconnector 7 pin	Std pkg 1	Servicing: HC-CARGO 171506, 171756, 171757, 171802, 171803, 171927, 171928, 171929, 171930, 172061, 172062, 172063, 172064, 171700	
<i>Gasket: HC-CARGO 192178. Terminal: HC-CARGO 193250.</i>			
			Type/terminal: Round Connection: M Colour: Black No./poles: 7 Plug: Female
172066 Multiconnector 6 pin	Std pkg 1	Servicing: HC-CARGO 171506, 171756, 171757, 171802, 171803, 171927, 171928, 171929, 171930, 172061, 172062, 172063, 172064	
			Type/terminal: Round Connection: J Colour: Black No./poles: 6 Plug: Female
181627 Bayonet connector	Std pkg 1	Servicing: HC-CARGO 181617	
		Voltage: 12	Mount.: Terminal No./poles: 8 DIN norm: 72580

TRAILER LAMPS LED (TRUCKS)

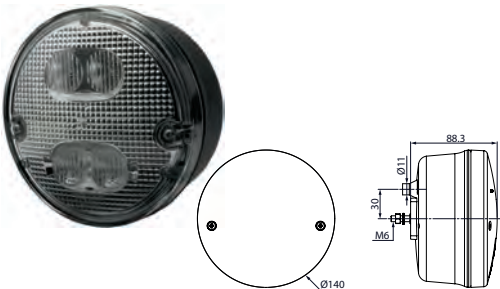
170909 LED Fog/Reverse Lamp	Std pkg 1		
<i>Lens and o-ring: HC-CARGO 170910.</i>			
		Voltage: 12/24	Dim.: 140x88.3 mm OD: 140 mm Dist. mount. holes: 45 mm
			Type: LED Fog/Reversing lamp Colour/glass: White Material: Shockproof plastic Shape: Round Fixing screw: 2 Rear/fog lamp: w/ Tail light: w/ LEDs: w/ No./LEDs: 4 E-approval: Yes

171549 LED Multifunction Lamp Std pkg 1

Mounting kit: HC-CARGO 171266.

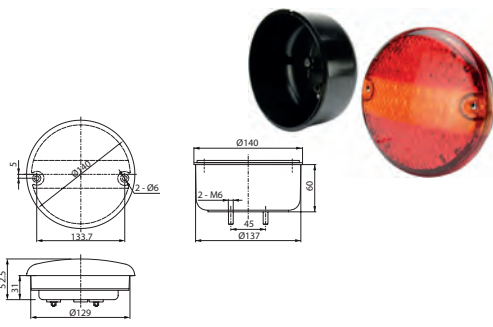

Voltage: 9-33

Dim.: 140x60 mm
Dist. mount. holes:
45 mm

Type: LED Multifunction Lamp
Connection: Terminal
Colour: Black
Material: Shockproof plastic
Shape: Round
Fixing screw: 2
Flasher light: w/
Numberplate light: w/o
Rear/fog lamp: w/o
Reverse light: w/o
Sidemarker: w/o
Sidemarker lamp: w/o
Tail light: w/
Stop light: w/
No./LEDs: 63
E-approval: Yes

171550 LED Multifunction Lamp Std pkg 1

w/ transparent lens when light is off. Mounting kit: HC-CARGO 171266.

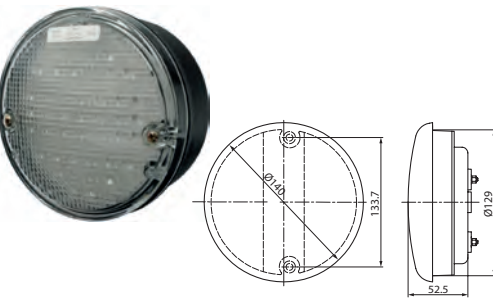

Voltage: 9-33

Dim.: 140x52.5 mm
Dist. mount. holes:
45 mm

Type: LED Multifunction Lamp
Connection: Terminal
Material: Shockproof plastic
Shape: Round
Fixing screw: 2
Flasher light: w/
Numberplate light: w/o
Rear/fog lamp: w/o
Reverse light: w/o
Sidemarker: w/o
Sidemarker lamp: w/o
Tail light: w/
Stop light: w/
No./LEDs: 63
E-approval: Yes

171665 LED Multifunction Lamp Std pkg 1

Right: HC-CARGO 171666.

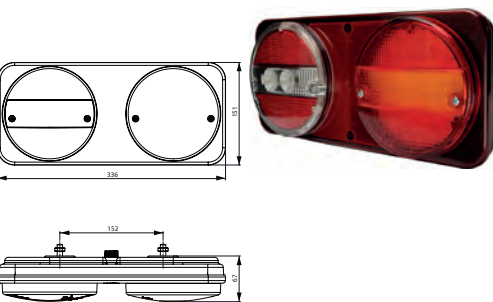

Voltage: 12/24

Dim.: 336x151x67 mm
Dist. mount. holes:
152 mm

Type: LED Multifunction Lamp
Connection: Terminal
Material: Shockproof plastic
Shape: Rectangular
Reflector: w/
Flasher light: w/
Numberplate light: w/o
Rear/fog lamp: w/o
Reverse light: w/
Sidemarker: w/o
Sidemarker lamp: w/o
Tail light: w/
Stop light: w/
RH/LH: LH
E-approval: Yes

171666 LED Multifunction Lamp Std pkg 1

Left: HC-CARGO 171665.

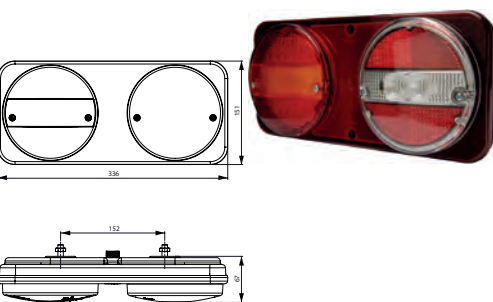

Voltage: 12/24

Dim.: 336x151x67 mm
Dist. mount. holes:
152 mm

Type: LED Multifunction Lamp
Connection: Terminal
Material: Shockproof plastic
Shape: Rectangular
Reflector: w/
Flasher light: w/
Numberplate light: w/o
Rear/fog lamp: w/o
Reverse light: w/
Sidemarker: w/o
Sidemarker lamp: w/o
Tail light: w/
Stop light: w/
RH/LH: RH
E-approval: Yes

171927 LED Multifunction Lamp Std pkg 1

Multi-plug: HC-CARGO 171788, 172066. Left: HC-CARGO 171928.

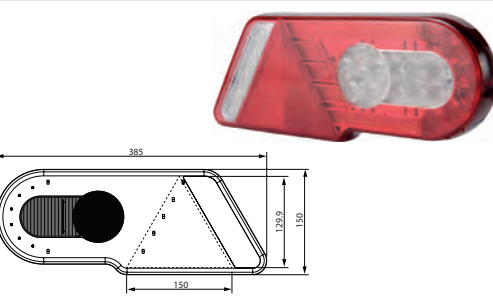

Voltage: 12-24

Dim.: 385x150x34.1 mm
Dist. mount. holes:
152.3 mm

Type: LED Multifunction Lamp
Connection: Multiplug
Shape: Rectangular
Reflector: w/
Flasher light: w/
Numberplate light: w/o
Rear/fog lamp: w/
Reverse light: w/
Sidemarker: w/o
Sidemarker lamp: w/o
Tail light: w/
Stop light: w/
RH/LH: RH
Tightness norm: IP 67
E-approval: Yes

171928 LED Multifunction Lamp Std pkg 1

Multi-plug: HC-CARGO 171788, 172066. Right: HC-CARGO 171927.

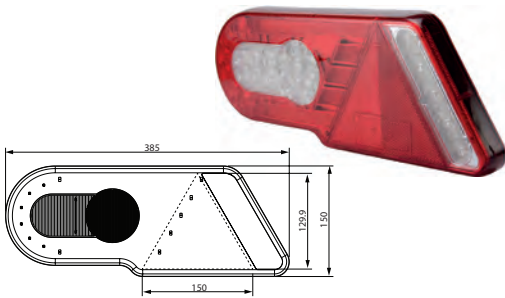

Voltage: 12-24

Dim.: 385x150x34.1 mm
Dist. mount. holes: 152 mm

Type: LED Multifunction Lamp
Connection: Multiplug
Shape: Rectangular
Reflector: w/
Flasher light: w/
Numberplate light: w/o
Rear/fog lamp: w/
Reverse light: w/
Sidemarker: w/o
Sidemarker lamp: w/o
Tail light: w/
Stop light: w/
RH/LH: LH
Tightness norm: IP 67
E-approval: Yes

171929 LED Multifunction Lamp Std pkg 1

Multi-plug: HC-CARGO 171788, 172066. Left: HC-CARGO 171930.

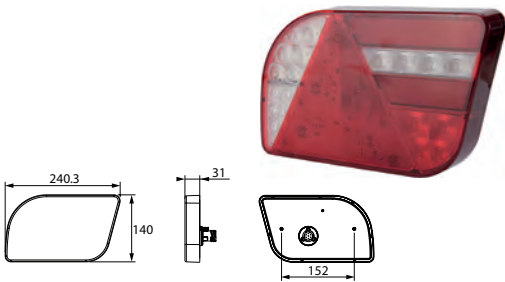

Voltage: 12-24

Dim.: 240.3x140x31 mm
Dist. mount. holes: 152 mm

Type: LED Multifunction Lamp
Connection: Multiplug
Shape: Rectangular
Reflector: w/
Flasher light: w/
Numberplate light: w/o
Rear/fog lamp: w/
Reverse light: w/
Sidemarker: w/o
Sidemarker lamp: w/o
Tail light: w/
Stop light: w/
RH/LH: RH
Tightness norm: IP 67
E-approval: Yes

171930 LED Multifunction Lamp Std pkg 1

Multi-plug: HC-CARGO 171788, 172066. Right: HC-CARGO 171929.

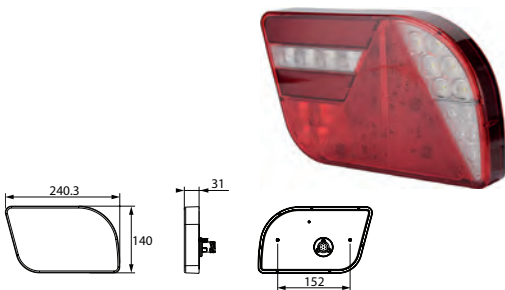

Voltage: 12-24

Dim.: 240.3x140x31 mm
Dist. mount. holes: 152 mm

Type: LED Multifunction Lamp
Connection: Multiplug
Shape: Rectangular
Reflector: w/
Flasher light: w/
Numberplate light: w/o
Rear/fog lamp: w/
Reverse light: w/
Sidemarker: w/o
Sidemarker lamp: w/o
Tail light: w/
Stop light: w/
RH/LH: LH
Tightness norm: IP 67
E-approval: Yes

171952 LED Multifunction Lamp Std pkg 1

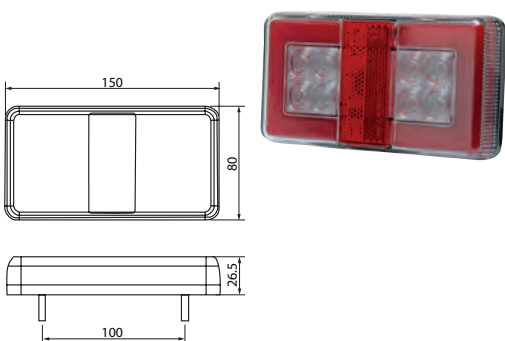

Voltage: 12-24

Dim.: 150x80x26.5 mm
Cable length: 300 mm
Dist. mount. holes: 100 mm

Type: LED Multifunction Lamp
Connection: Cable
Shape: Rectangular
Mount.: 2 screws
Reflector: w/
No./reflectors: 1
Flasher light: w/
Numberplate light: w/o
Rear/fog lamp: w/o
Reverse light: w/o
Sidemarker: w/o
Sidemarker lamp: w/o
Tail light: w/
Stop light: w/
Tightness norm: IP 67
Approval: CE
E-approval: Yes

172061 LED Multifunction Lamp Std pkg 1

Lens: HC-CARGO 172065. Plug: HC-CARGO 171788, 172066. Left: HC-CARGO 172062.

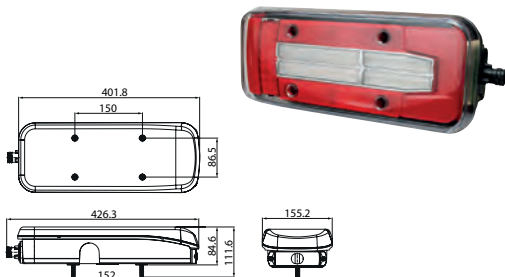

Voltage: 12-24

Dim.: 426.3x155.2x111.6 mm
Dist. mount. holes: 152 mm

Type: LED
Material: PP
Material/dome: Polycarbonate
Shape: Rectangular
Reflector: w/
Flasher light: w/
Numberplate light: w/o
Rear/fog lamp: w/
Reverse light: w/
Sidemarker: w/o
Sidemarker lamp: w/
Tail light: w/
Stop light: w/
RH/LH: RH
E-approval: Yes

172062 LED Multifunction Lamp Std pkg 1

Lens: HC-CARGO 172065. Plug: HC-CARGO 171788, 172066. Right: HC-CARGO 172061.

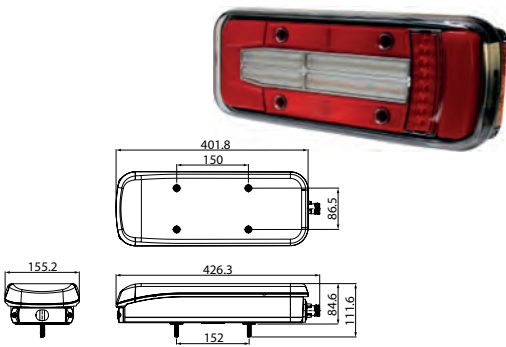

Voltage: 12-24

Dim.: 426.3x155.2x111.6 mm
Dist. mount. holes: 152 mm

Type: LED
Material: PP
Material/dome: Polycarbonate
Shape: Rectangular
Reflector: w/
Flasher light: w/
Numberplate light: w/o
Rear/fog lamp: w/
Reverse light: w/
Sidemarker: w/o
Sidemarker lamp: w/
Tail light: w/
Stop light: w/
RH/LH: LH
E-approval: Yes

172063 LED Multifunction Lamp Std pkg 1

Lens: HC-CARGO 172067. Plug: HC-CARGO 171788, 172066. Left: HC-CARGO 172064.

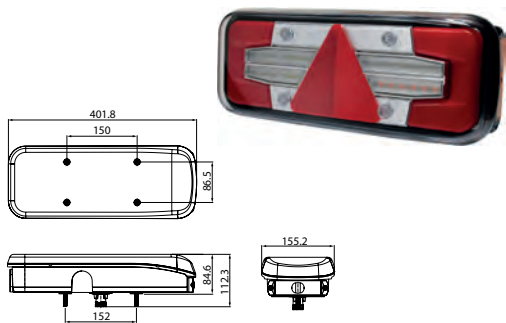

Voltage: 12-24

Dim.: 401.8x155.2x112.3 mm
Dist. mount. holes: 152 mm

Type: LED
Material: PP
Material/dome: Polycarbonate
Shape: Rectangular
Reflector: w/
Flasher light: w/
Numberplate light: w/o
Rear/fog lamp: w/
Reverse light: w/
Sidemarker: w/o
Sidemarker lamp: w/
Tail light: w/
Stop light: w/
RH/LH: RH
E-approval: Yes

172064 LED Multifunction Lamp Std pkg 1

Lens: HC-CARGO 172067. Plug: HC-CARGO 171788, 172066. Right: HC-CARGO 172063.

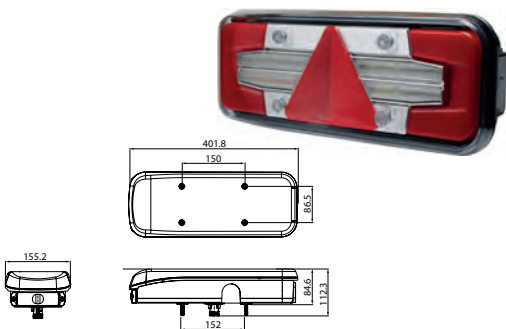

Voltage: 12-24

Dim.: 401.8x155.2x112.3 mm
Dist. mount. holes: 152 mm

Type: LED
Material: PP
Material/dome: Polycarbonate
Shape: Rectangular
Reflector: w/
Flasher light: w/
Numberplate light: w/o
Rear/fog lamp: w/
Reverse light: w/
Sidemarker: w/o
Sidemarker lamp: w/
Tail light: w/
Stop light: w/
RH/LH: LH
E-approval: Yes

172215 LED Multifunction Lamp Std pkg 1

With built-in resistor.

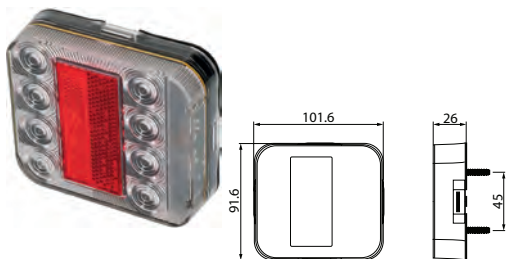

Voltage: 12

Dim.: 101.6x91.6x26 mm
Cable length: 500 mm
Dist. mount. holes: 45 mm

Type: LED Multifunction Lamp
Connection: Cable
Shape: Square
Mount.: 4 holes
Reflector: w/
Flasher light: w/
Tail light: w/
Stop light: w/
LEDs: w/
RH/LH: RH/LH
Tightness norm: IP 67
E-approval: Yes

SPARE PARTS

172065 Lens, Rear Lamp

Std pkg 1 Servicing: HC-CARGO 172061, 172062





Dim.: 401.8x155.2 mm

Material/dome: Polycarbonate
RH/LH: RH/LH

172067 Lens, Rear Lamp	Std pkg 1	Servicing: HC-CARGO 172063, 172064		Dim.: 401.8x155.2 mm	Material/dome: Polycarbonate RH/LH: RH/LH
					

ACCESSORIES

160970 Load Resistor 12 V	Std pkg 1				
<i>Contains: 2 pcs.</i>					
			Voltage: 12 Amp: 2 Watt: 50	Length: 50 mm Width: 15 mm	

160971 Load Resistor 24 V	Std pkg 1				
<i>Contains: 2 pcs.</i>					
			Voltage: 24 Amp: 1 Watt: 50	Length: 50 mm Width: 15 mm	

TAIL LAMPS CONVENTIONAL

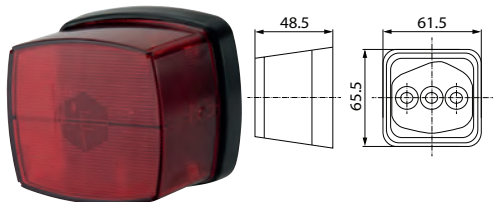
171173 Tail Lamp	Std pkg 1				
 					
		Bulb incl.: No Watt: 5	Dim.: 62x62x45 mm Dist. mount. holes: 30 mm	Socket type: S8.5 Connection: Terminal Colour/glass: Red Material: Shockproof plastic Shape: Rectangular Fixing screw: 2 Sidemarker: w/ E-approval: Yes	

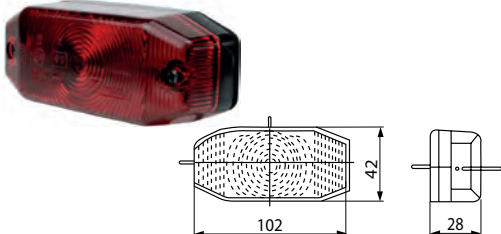
171331 Tail Lamp	Std pkg 1				
					
		Bulb incl.: No Watt: 5	Dim.: 102x42x28 mm Dist. mount. holes: 65 mm	Socket type: S8.5 Connection: Terminal Colour/glass: Red Material: Plastic Shape: Hexagon Fixing screw: 2 E-approval: Yes	

TAIL LAMPS LED

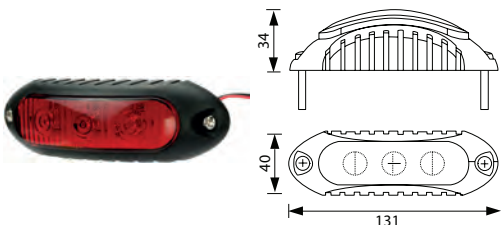
171635 LED Tail Lamp	Std pkg 1				
					
		Voltage: 9-36	Dim.: 131x40x34 mm Dist. mount. holes: 115 mm	Type: LED Tail lamp Connection: Cable Colour/glass: Red Material: PP/PMMA Shape: Oval Tail light: w/ No./LEDs: 3 E-approval: Yes	

171637 LED Tail Lamp Std pkg 1

Angle Bracket: HC-CARGO 171639.

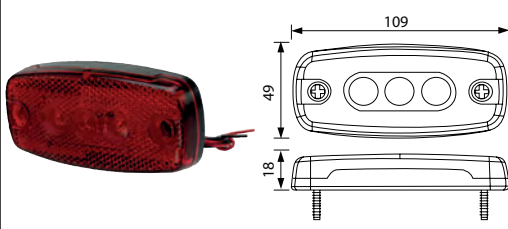

Voltage: 9-36
Watt: 0.9

Dim.: 109x49x18 mm
Dist. mount. holes:
83 mm

Type: LED Tail lamp
Colour/glass: Red
Shape: Rectangular
Reflector: w/
Tail light: w/
No./LEDs: 3
E-approval: Yes

171719 LED Tail Lamp Std pkg 1

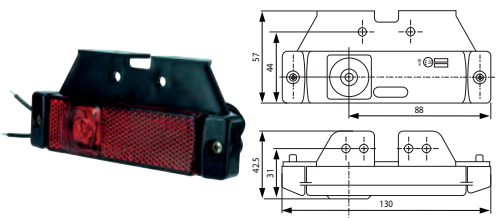

Voltage: 12/24

Dim.: 130x57x42.5 mm
Dist. mount. holes:
50 mm

Type: LED Tail lamp
Connection: Cable
Colour/glass: Red
Material: Shockproof plastic
Shape: Rectangular
Bracket: Angled
Reflector: w/
Tail light: w/
No./LEDs: 1
E-approval: Yes

171720 LED Tail Lamp Std pkg 1

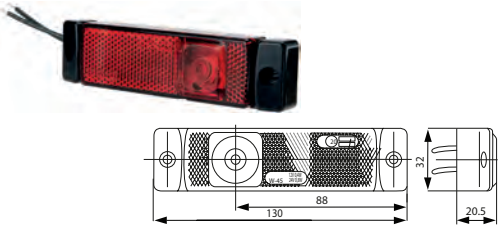

Voltage: 12/24

Dim.: 130x32x20.5 mm
Dist. mount. holes:
50 mm

Type: LED Tail lamp
Connection: Cable
Colour/glass: Red
Material: Shockproof plastic
Shape: Rectangular
Reflector: w/
Tail light: w/
No./LEDs: 1
E-approval: Yes

171743 LED Tail Lamp Std pkg 1

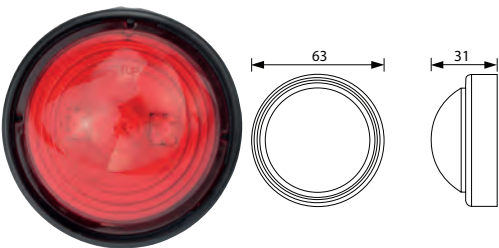

Voltage: 9-36

Dim.: 63x31 mm
Cable length: 300 mm
Dist. mount. holes:
30 mm

Type: LED Tail lamp
Connection: Cable
Colour: Black
Colour/glass: Red
Material: PVC
Material/dome: PMMA
Shape: Round
Mount.: 2 screws
Tail light: w/
No./LEDs: 3
Approval: SAE/ECE
E-approval: Yes

171771 LED Tail Lamp Std pkg 1

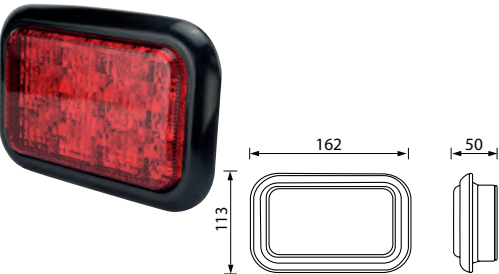

Voltage: 24
Watt: 2.5

Dim.: 162x113x50 mm

Type: LED Tail lamp
Connection: Multiplug
Colour/glass: Red
Material: ABS plastic
Material/dome: PMMA
Shape: Rectangular
Mount.: Plan installation
Tail light: w/
Stop light: w/
No./LEDs: 16
RH/LH: RH/LH
E-approval: Yes



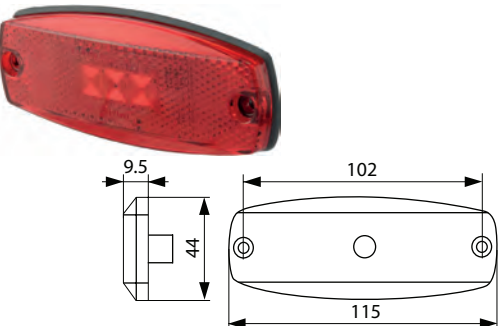





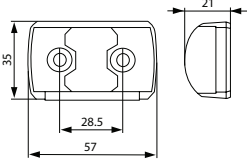

171840 LED Tail Lamp Std pkg 1

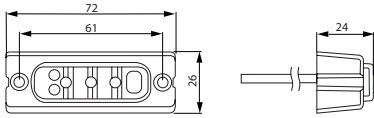

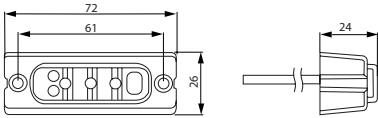
Voltage: 12/24
Watt: 0.45-1.6

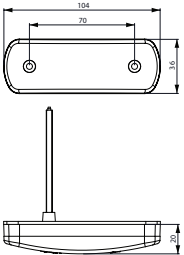
Dim.: 115x44x9.5 mm
Cable length: 5000 mm
Dist. mount. holes:
102 mm

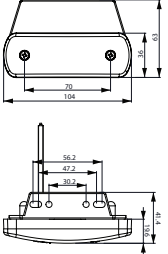
Type: LED Tail lamp
Connection: Cable
Colour: Red
Colour/glass: Red
Material: Polycarbonate
Material/dome: Polycarbonate
Shape: Rectangular
Mount.: 2 screws
Reflector: w/
Tail light: w/
No./LEDs: 3
Tightness norm: IP 67
Approval: SAE
E-approval: Yes

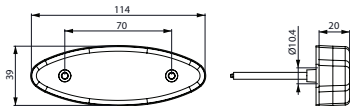
		EL. SPECIFICATIONS	DIMENSIONS	ADDITIONAL SPECIFICATIONS
171843	LED Tail Lamp	Std pkg 1		
		Voltage: 12/24	Dim.: 57x35x21 mm Cable length: 400 mm Dist. mount. holes: 28 mm	Type: LED Tail lamp Connection: Cable Colour: Black Colour/glass: Red Shape: Rectangular Fixing screw: 2 Tail light: w/ No./LEDs: 2 Tightness norm: IP 67 E-approval: Yes
171861	LED Tail Lamp	Std pkg 1		
		Voltage: 12/24 Watt: 0.3-0.6	Dim.: 72x26x24 mm Cable length: 5000 mm	Type: LED Tail lamp Colour: Black Colour/glass: Red Material: PP Material/dome: PMMA Shape: Rectangular Fixing screw: 2 Tail light: w/ No./LEDs: 3 Approval: CE E-approval: Yes
171867	LED Tail Lamp	Std pkg 1		
		Voltage: 12/24 Watt: 0.3-0.6	Dim.: 72x26x24 mm Cable length: 5000 mm	Type: LED Tail lamp Colour: Black Colour/glass: Red Material: PP Material/dome: PMMA Shape: Rectangular Bracket: Adjustable Fixing screw: 2 Tail light: w/ No./LEDs: 3 Approval: CE E-approval: Yes
172034	LED Tail Lamp	Std pkg 1		
		Voltage: 12/24	Dim.: 104x36x20 mm Cable length: 500 mm Dist. mount. holes: 70 mm	Type: LED Tail lamp Colour/glass: Red Material: Shockproof plastic Shape: Rectangular Reflector: w/ Fixing screw: 2 Tail light: w/ No./LEDs: 3 E-approval: Yes
172035	LED Tail Lamp	Std pkg 1		
		Voltage: 12/24	Dim.: 104x36x20 mm Cable length: 500 mm Dist. mount. holes: 70 mm	Type: LED Tail lamp Colour/glass: Red Material: Shockproof plastic Shape: Rectangular Bracket: Angled Reflector: w/ Fixing screw: 2 Tail light: w/ No./LEDs: 3 E-approval: Yes
172040	LED Tail Lamp	Std pkg 1		
		Voltage: 12/24	Dim.: 114x39x20 mm Cable length: 500 mm Dist. mount. holes: 70 mm	Type: LED Tail lamp Colour/glass: Red Material: Shockproof plastic Shape: Oval Reflector: w/ Fixing screw: 2 Tail light: w/ No./LEDs: 3 Approval: ADR E-approval: Yes

TAIL POSITION LAMPS CONVENTIONAL
170552 Tail/Position Lamp

Std pkg 1

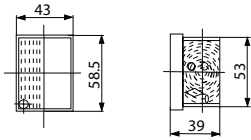

 Bulb incl.: No
Watt: 5

 Dim.: 58.5x43x39 mm
Dist. mount. holes:
25 mm

 Socket type: S8.5
Connection: Terminal
Colour/glass: Red/white
Material: Shockproof plastic
Shape: Rectangular
Fixing screw: 2
Sidemarker: w/
Tail light: w/
RH/LH: RH/LH
E-approval: Yes

170632 Tail/Position Lamp

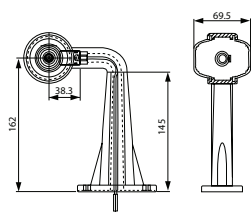
Std pkg 1

Lens: HC-CARGO 170635, 170636.

 Bulb incl.: No
Watt: 10

 Dim.: 162x69.5 mm
Dist. mount. holes:
76 mm

 Socket type: BA15S
Colour/glass: Red/white
Shape: Round
Sidemarker: w/
Tail light: w/
E-approval: Yes

170633 Tail/Position Lamp

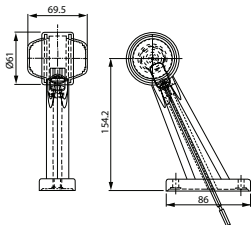
Std pkg 1

Lens: HC-CARGO 170635, 170636.

 Bulb incl.: No
Watt: 10

 Dim.: 154.2x69.5 mm
Dist. mount. holes:
75 mm

 Socket type: BA15S
Connection: Cable
Colour/glass: Red/white
Shape: Round
Sidemarker: w/
Tail light: w/
E-approval: Yes

170640 Tail/Position Lamp

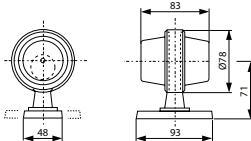
Std pkg 1

Lens: HC-CARGO 170642, 170641. Bulb holder: HC-CARGO 170671.

 Bulb incl.: No
Watt: 5

 Dim.: 110x78x93 mm
OD: 60 mm
Dist. mount. holes:
75 mm

 Socket type: BA15S
Colour/glass: Red/white
Shape: Round
Sidemarker: w/
Tail light: w/
E-approval: Yes

170668 Tail/Position Lamp

Std pkg 1

Servicing: Nissan - Visit our web catalogue for further information

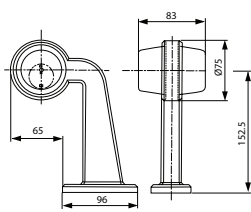
Lens: HC-CARGO 170642, 170641. Bulb holder: HC-CARGO 170671. Bulbs: HC-CARGO 170773.

 Bulb incl.: No
Watt: 5

 Dim.: 152.5x83 mm
OD: 60 mm
Dist. mount. holes:
74 mm

 Socket type: BA15S
Colour/glass: Red/white
Shape: Round
Sidemarker: w/
Tail light: w/
E-approval: Yes

171196 Tail/Position Lamp

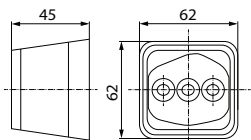
Std pkg 1

 Bulb incl.: No
Watt: 5

 Dim.: 62x62x45 mm
Dist. mount. holes:
30 mm

 Socket type: S8.5
Connection: Terminal
Colour/glass: Red/white
Material: Shockproof plastic
Shape: Square
Fixing screw: 2
Sidemarker: w/
Tail light: w/
RH/LH: RH/LH
E-approval: Yes

171627 Tail/Position Lamp Std pkg 1 <i>Tail/Position Lamp: HC-CARGO 171706.</i>			Bulb incl.: No Voltage: 12/24 Watt: 5	Dim.: 143x40x35 mm Dist. mount. holes: 30 mm	Socket type: S8.5 Connection: Screw Material: Plastic Shape: Rectangular Sidemarkers: w/ Tail light: w/ Approval: ADR E-approval: Yes
--	--	--	--	---	--

171706 Tail/Position Lamp Std pkg 1 Servicing: HC-CARGO 171627			Bulb incl.: No Voltage: 12/24 Watt: 5	Dim.: 74x40x37 mm Dist. mount. holes: 45 mm	Socket type: S8.5 Connection: Screw Shape: Rectangular Sidemarkers: w/ Tail light: w/ Approval: ADR E-approval: Yes
---	--	--	--	--	--

SPARE PARTS

170635 Lens Std pkg 1 Servicing: HC-CARGO 170632, 170633					Colour/glass: White Material: Glass Shape: Round
---	--	--	--	--	---

170636 Lens Std pkg 1 Servicing: HC-CARGO 170632, 170633					Colour/glass: Red Material: Glass Shape: Round
---	--	--	--	--	---

170641 Lens Std pkg 1 Servicing: HC-CARGO 170640, 170668					Colour/glass: Red Material: Glass Shape: Round
---	--	--	--	--	---

170642 Lens Std pkg 1 Servicing: HC-CARGO 170640, 170668					Colour/glass: White Material: Glass Shape: Round
---	--	--	--	--	---

170671 Bulb Holder Std pkg 1 Servicing: HC-CARGO 170640, 170668, 170713					
--	--	--	--	--	--

TAIL POSITION LAMPS LED
171528 LED Tail-Position Lamp Std pkg 1

Flange 100x41 mm.

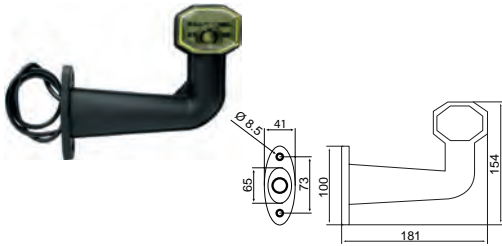

Voltage: 24

 Dim.: 181x154x48 mm
 Cable length: 700 mm
 Dist. mount. holes:
 73 mm

 Type: LED Tail/position lamp
 Connection: Cable
 Colour/glass: Red/white
 Material: Rubber
 Material/dome: Shockproof plastic
 Shape: Hexagon
 Fixing screw: 2
 Sidemarker: w/
 Tail light: w/
 No./LEDs: 2x1
 RH/LH: RH/LH
 E-approval: Yes

171529 LED Tail-Position Lamp Std pkg 1

Flange 100x41 mm.

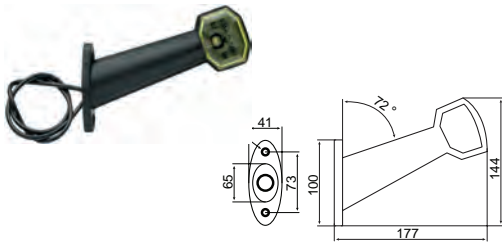

Voltage: 24

 Dim.: 177x144x48 mm
 Cable length: 700 mm
 Dist. mount. holes:
 73 mm

 Type: LED Tail/position lamp
 Connection: Cable
 Colour/glass: Red/white
 Material: Rubber
 Material/dome: Shockproof plastic
 Shape: Hexagon
 Fixing screw: 2
 Sidemarker: w/
 Tail light: w/
 No./LEDs: 2x1
 RH/LH: RH/LH
 E-approval: Yes

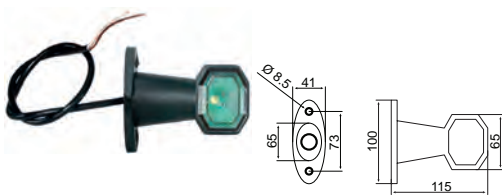
171530 LED Tail-Position Lamp Std pkg 1

Voltage: 24

 Dim.: 115x65x48 mm
 Cable length: 700 mm
 Dist. mount. holes:
 73 mm

 Type: LED Tail/position lamp
 Connection: Cable
 Colour/glass: Red/white
 Material: Rubber
 Material/dome: Shockproof plastic
 Shape: Hexagon
 Fixing screw: 2
 Sidemarker: w/
 Tail light: w/
 No./LEDs: 2x1
 RH/LH: RH/LH
 E-approval: Yes

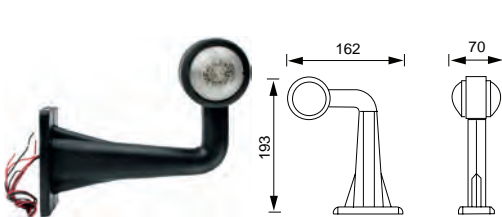
171591 LED Tail-Position Lamp Std pkg 1

Voltage: 9-36

 Dim.: 193x162x70 mm
 Dist. mount. holes:
 78 mm

 Type: LED Tail/position lamp
 Connection: Cable
 Colour/glass: Red/white
 Shape: Round
 Sidemarker: w/
 Tail light: w/
 No./LEDs: 2x3
 RH/LH: RH/LH
 Approval: ADR/SAE
 E-approval: Yes

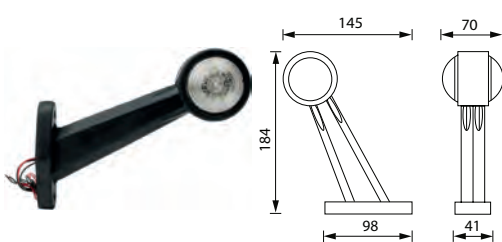
171592 LED Tail-Position Lamp Std pkg 1

Voltage: 9-36

 Dim.: 184x145x70 mm
 Dist. mount. holes:
 78 mm

 Type: LED Tail/position lamp
 Connection: Cable
 Colour/glass: Red/white
 Shape: Round
 Sidemarker: w/
 Tail light: w/
 No./LEDs: 2x3
 RH/LH: RH/LH
 Approval: SAE
 E-approval: Yes

171593 LED Tail-Position Lamp Std pkg 1

Voltage: 9-36

 Dim.: 75x89x62 mm
 OD: 45 mm
 Dist. mount. holes:
 78 mm

 Type: LED Tail/position lamp
 Connection: Cable
 Colour/glass: Red/white
 Material: Rubber
 Shape: Round
 Sidemarker: w/
 Tail light: w/
 No./LEDs: 2x3
 RH/LH: RH/LH
 Approval: ADR/SAE
 E-approval: Yes

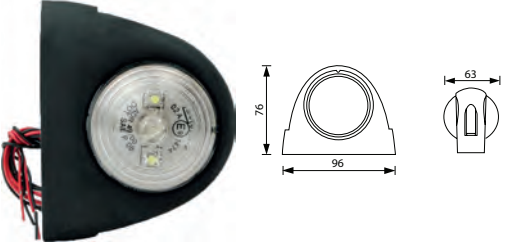
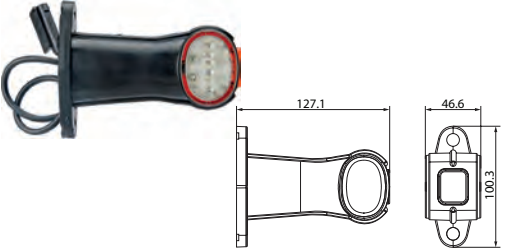
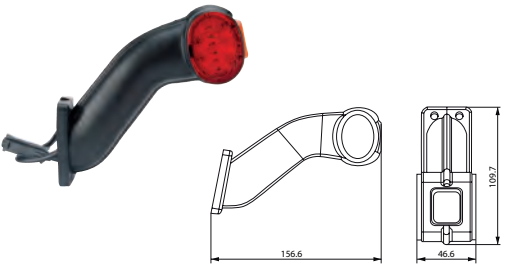
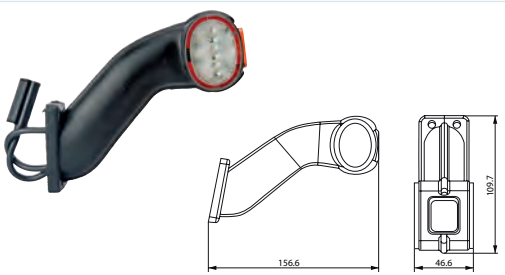
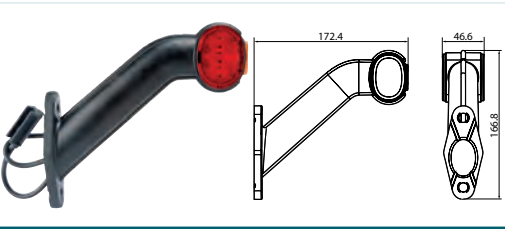
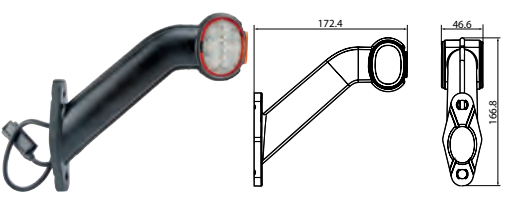
<p>171617 LED Tail-Position Lamp Std pkg 1</p> 	<p>Voltage: 9-36</p>	<p>Dim.: 96x76x63 mm OD: 76 mm Dist. mount. holes: 78 mm</p>	<p>Type: LED Tail/position lamp Connection: Cable Colour/glass: Red/white Material: Synthetic rubber Shape: Round Sidemarkers: w/ Tail light: w/ No./LEDs: 2x3 RH/LH: RH/LH Approval: ADR/SAE E-approval: Yes</p>
<p>171730 LED Tail/Position/Side Marker Std pkg 1</p>			
<p>w/ 128 mm rubber arm. Cover of click-in connector: HC-CARGO 172016.</p>			
	<p>Voltage: 12/24</p>	<p>Dim.: 127.1x100.3 mm Cable length: 500 mm Dist. mount. holes: 78 mm</p>	<p>Type: LED Tail/position/side marker lamp Connection: Cable Shape: Oval Mount.: 2 screws Sidemarkers: w/ Sidemarkers lamp: w/ Tail light: w/ No./LEDs: 7 RH/LH: RH/LH Tightness norm: IP 67 E-approval: Yes</p>
<p>171731 LED Tail/Position/Side Marker Std pkg 1</p>			
<p>w/ 145 mm rubber arm. Cover of click-in connector: HC-CARGO 172016.</p>			
	<p>Voltage: 12/24</p>	<p>Dim.: 142.2x130.5x40.5 mm Cable length: 450 mm Dist. mount. holes: 52 mm</p>	<p>Type: LED Tail/position/side marker lamp Connection: Cable Colour: Black Material: Rubber Shape: Oval Mount.: 4 holes Sidemarkers: w/ Sidemarkers lamp: w/ Tail light: w/ No./LEDs: 9 RH/LH: RH E-approval: Yes</p>
<p>171732 LED Tail/Position/Side Marker Std pkg 1</p>			
<p>Cover of click-in connector: HC-CARGO 172016.</p>			
	<p>Voltage: 12/24</p>	<p>Dim.: 142.2x130.5x40.5 mm Cable length: 450 mm Dist. mount. holes: 52 mm</p>	<p>Type: LED Tail/position/side marker lamp Connection: Cable Colour: Black Material: Rubber Shape: Oval Mount.: 4 holes Sidemarkers: w/ Sidemarkers lamp: w/ Tail light: w/ No./LEDs: 9 RH/LH: LH E-approval: Yes</p>
<p>171733 LED Tail/Position/Side Marker Std pkg 1</p>			
<p>Cover of click-in connector: HC-CARGO 172016.</p>			
	<p>Voltage: 12/24</p>	<p>Dim.: 172.4x166.8x46.6 mm Cable length: 500 mm Dist. mount. holes: 78 mm</p>	<p>Type: LED Tail/position/side marker lamp Connection: Cable Shape: Oval Mount.: 2 screws Sidemarkers: w/ Sidemarkers lamp: w/ Tail light: w/ No./LEDs: 7 RH/LH: RH</p>
<p>171734 LED Tail/Position/Side Marker Std pkg 1</p>			
<p>Cover of click-in connector: HC-CARGO 172016.</p>			
	<p>Voltage: 12/24</p>	<p>Dim.: 172.4x166.8x46.6 mm Cable length: 500 mm Dist. mount. holes: 78 mm</p>	<p>Type: LED Tail/position/side marker lamp Connection: Cable Shape: Oval Mount.: 2 screws Sidemarkers: w/ Sidemarkers lamp: w/ Tail light: w/ No./LEDs: 7 RH/LH: LH</p>

EL. SPECIFICATIONS		DIMENSIONS	ADDITIONAL SPECIFICATIONS
171958 LED Tail-Position Lamp Std pkg 1 		Voltage: 12-24 Dim.: 148.5x125.5x89 mm Cable length: 300 mm Dist. mount. holes: 63.5/75/29 mm	Type: LED Tail/position lamp Connection: Cable Colour: Black Colour/glass: Red/white Material: Rubber Material/dome: Shockproof plastic Shape: Round Mount.: 6 screws Sidemarkers: w/ Tail light: w/ RH/LH: RH Tightness norm: IP 68 E-approval: Yes
171959 LED Tail-Position Lamp Std pkg 1 		Voltage: 12-24 Dim.: 148.5x125.5x89 mm Cable length: 300 mm Dist. mount. holes: 63.5/75/29 mm	Type: LED Tail/position lamp Connection: Cable Colour: Black Colour/glass: Red/white Material: Rubber Material/dome: Shockproof plastic Shape: Round Mount.: 6 screws Sidemarkers: w/ Tail light: w/ RH/LH: LH Tightness norm: IP 68 E-approval: Yes
171960 LED Tail-Position Lamp Std pkg 1 		Voltage: 12-24 Dim.: 97x78x49 mm Cable length: 300 mm Dist. mount. holes: 75/63.5/29 mm	Type: LED Tail/position lamp Connection: Cable Colour: Black Colour/glass: Red/white Material: Rubber Material/dome: Shockproof plastic Shape: Round Mount.: 6 screws Sidemarkers: w/ Tail light: w/ RH/LH: RH/LH Tightness norm: IP 68 E-approval: Yes
171961 LED Tail-Position Lamp Std pkg 1 		Voltage: 12-24 Dim.: 180x157.6x89 mm Cable length: 300 mm Dist. mount. holes: 75/63.5/29 mm	Type: LED Tail/position lamp Connection: Cable Colour: Black Colour/glass: Red/white Material: Rubber Material/dome: Shockproof plastic Shape: Round Mount.: 6 screws Sidemarkers: w/ Tail light: w/ RH/LH: RH Tightness norm: IP 68 E-approval: Yes
171962 LED Tail-Position Lamp Std pkg 1 		Voltage: 12-24 Dim.: 180x157.6x89 mm Cable length: 300 mm Dist. mount. holes: 75/63.5/29 mm	Type: LED Tail/position lamp Connection: Cable Colour: Black Colour/glass: Red/white Material: Rubber Material/dome: Shockproof plastic Shape: Round Mount.: 6 screws Sidemarkers: w/ Tail light: w/ RH/LH: LH Tightness norm: IP 68 E-approval: Yes

		EL. SPECIFICATIONS	DIMENSIONS	ADDITIONAL SPECIFICATIONS
171963 LED Tail-Position Lamp Std pkg 1				
		Voltage: 12-24	Dim.: 135x89x49.5 mm Cable length: 300 mm Dist. mount. holes: 75/63.5/29 mm	Type: LED Tail/position lamp Connection: Cable Colour: Black Colour/glass: Red/white Material: Rubber Material/dome: Shockproof plastic Shape: Round Mount.: 6 screws Sidemarkers: w/ Tail light: w/ RH/LH: RH/LH Tightness norm: IP 68 E-approval: Yes
171964 LED Tail-Position Lamp Std pkg 1				
		Voltage: 12-24	Dim.: 134.5x108x89 mm Cable length: 300 mm Dist. mount. holes: 75/63.5/29 mm	Type: LED Tail/position lamp Connection: Cable Colour: Black Colour/glass: Red/white Material: Rubber Material/dome: Shockproof plastic Shape: Round Mount.: 6 screws Sidemarkers: w/ Tail light: w/ RH/LH: RH Tightness norm: IP 68 E-approval: Yes
171965 LED Tail-Position Lamp Std pkg 1				
		Voltage: 12-24	Dim.: 134.5x108x89 mm Cable length: 300 mm Dist. mount. holes: 75/63.5/29 mm	Type: LED Tail/position lamp Connection: Cable Colour: Black Colour/glass: Red/white Material: Rubber Material/dome: Shockproof plastic Shape: Round Mount.: 6 screws Sidemarkers: w/ Tail light: w/ RH/LH: LH Tightness norm: IP 68 E-approval: Yes
171966 LED Tail/Position/Side Marker Std pkg 1				
		Voltage: 12-24	Dim.: 187x165x37 mm Cable length: 300 mm Dist. mount. holes: 79 mm	Type: LED Tail/position/side marker lamp Connection: Cable Colour: Black Colour/glass: Transparent Material: Rubber Material/dome: Shockproof plastic Shape: Rectangular Mount.: 2 screws Sidemarkers: w/ Sidemarkers lamp: w/ Tail light: w/ RH/LH: RH Tightness norm: IP 68 E-approval: Yes
171967 LED Tail/Position/Side Marker Std pkg 1				
		Voltage: 12-24	Dim.: 187x165x37 mm Cable length: 300 mm Dist. mount. holes: 79 mm	Type: LED Tail/position/side marker lamp Connection: Cable Colour: Black Colour/glass: Transparent Material: Rubber Material/dome: Shockproof plastic Shape: Rectangular Mount.: 2 screws Sidemarkers: w/ Sidemarkers lamp: w/ Tail light: w/ RH/LH: LH Tightness norm: IP 68 E-approval: Yes

171968 LED Tail/Position/Side Marker Std pkg 1

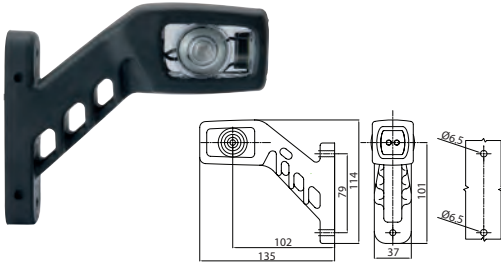

Voltage: 12-24

Dim.: 135x114x37 mm
Cable length: 300 mm
Dist. mount. holes:
79 mm

Type: LED Tail/position/side marker lamp
Connection: Cable
Colour: Black
Colour/glass: Transparent
Material: Rubber
Material/dome: Shockproof plastic
Shape: Rectangular
Mount.: 2 screws
Sidemarker: w/
Sidemarker lamp: w/
Tail light: w/
RH/LH: RH
Tightness norm: IP 68
E-approval: Yes

171969 LED Tail/Position/Side Marker Std pkg 1

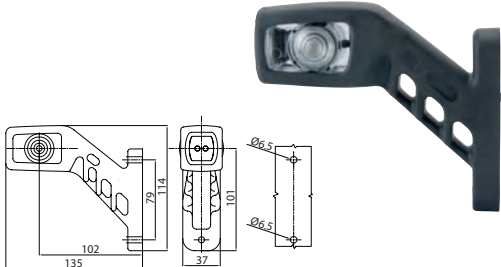

Voltage: 12-24

Dim.: 135x114x37 mm
Cable length: 300 mm
Dist. mount. holes:
79 mm

Type: LED Tail/position/side marker lamp
Connection: Cable
Colour: Black
Colour/glass: Transparent
Material: Rubber
Material/dome: Shockproof plastic
Shape: Rectangular
Mount.: 2 screws
Sidemarker: w/
Sidemarker lamp: w/
Tail light: w/
RH/LH: LH
Tightness norm: IP 68
E-approval: Yes

171970 LED Tail/Position/Side Marker Std pkg 1

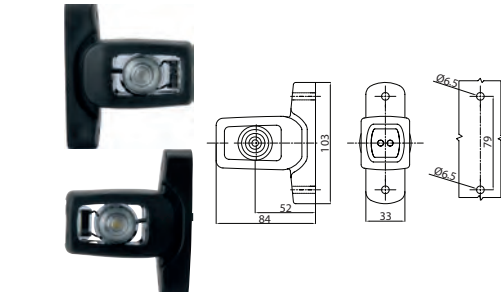

Voltage: 12-24

Dim.: 103x84x33 mm
Cable length: 300 mm
Dist. mount. holes:
79 mm

Type: LED Tail/position/side marker lamp
Connection: Cable
Colour: Black
Colour/glass: Transparent
Material: Rubber
Material/dome: Shockproof plastic
Shape: Rectangular
Mount.: 2 screws
Sidemarker: w/
Sidemarker lamp: w/
Tail light: w/
RH/LH: RH/LH
Tightness norm: IP 68
E-approval: Yes

NUMBERPLATE LAMPS CONVENTIONAL

170002 Numberplate Lamp Std pkg 1

Servicing: Universal - Visit our web catalogue for further information

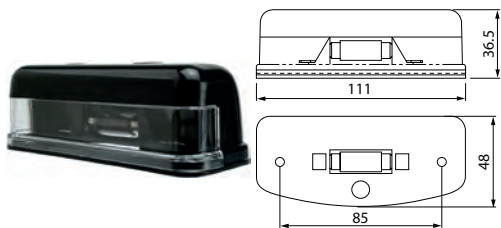

Bulb incl.: Yes
Voltage: 12/24
Watt: 5

Dim.: 111x36.5x48 mm

Socket type: S8.5
Colour: Black
Shape: Rectangular
Approval: CE

170936 Numberplate Lamp Std pkg 1

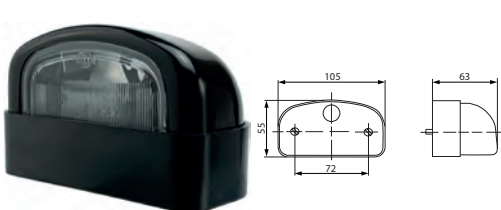

Bulb incl.: No
Voltage: 12
Watt: 5

Dim.: 105x55x63 mm
Dist. mount. holes:
72 mm

Type: Illumination of numberplate
Socket type: S8.5
Connection: Screw
Colour: Black
Material: Shockproof plastic
Shape: Rectangular
Fixing screw: 2
Numberplate light: w/
E-approval: Yes



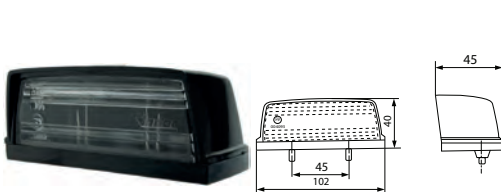







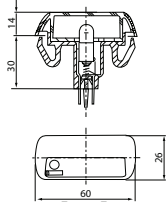

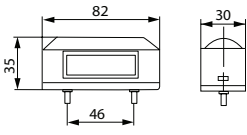
171045 Numberplate Lamp Std pkg 1

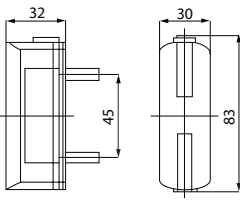

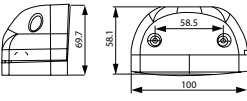
Bulb incl.: No
Voltage: 12/24
Watt: 5

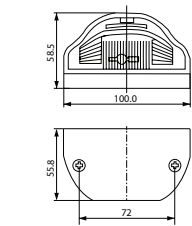
Dim.: 102x40x45 mm
Dist. mount. holes:
45 mm

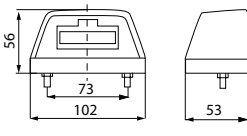
Type: Illumination of numberplate
Socket type: S8.5
Connection: Terminal
Colour: Black
Material: Shockproof plastic
Shape: Rectangular
Fixing screw: 2
E-approval: Yes

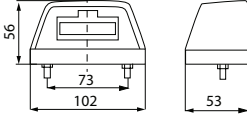
171164 Numberplate Lamp		Std pkg 1	Servicing: Ford, Universal - Visit our web catalogue for further information	
		Bulb incl.: No Voltage: 12 Watt: 5		Type: Illumination of numberplate Socket type: T10 Shape: Rectangular E-approval: Yes
171166 Numberplate Lamp		Std pkg 2	Universal.	
		Bulb incl.: No Voltage: 12/24 Watt: 5	Dim.: 82x35x30 mm Dist. mount. holes: 46 mm	Type: Illumination of numberplate Socket type: S8.5 Connection: Screw Colour: Black Shape: Rectangular Fixing screw: 2 E-approval: Yes Alternativ no.: 171224
171224 Numberplate Lamp		Std pkg 1	RADEX s.r.l.	
		Bulb incl.: No Voltage: 12/24 Watt: 5	Dim.: 82.7x28x31.6 mm Dist. mount. holes: 45 mm	Type: Illumination of numberplate Socket type: S8.5 Connection: Screw Colour: Black Material: Shockproof plastic Shape: Rectangular Fixing screw: 2 E-approval: Yes Alternativ no.: 171166
171345 Numberplate Lamp		Std pkg 1		
		Bulb incl.: No Watt: 5	Dim.: 100x58.1x69.7 mm Dist. mount. holes: 58.5 mm	Type: Illumination of numberplate Socket type: S8.5 Connection: Screw Colour: Black Material: Plastic Shape: Rectangular Fixing screw: 2 E-approval: Yes
171823 Numberplate Lamp		Std pkg 1		
		Bulb incl.: No Watt: 5	Dim.: 100x58.5x55.8 mm Dist. mount. holes: 72 mm	Type: Illumination of numberplate Socket type: S8.5 Connection: Screw Colour: Black Colour/glass: Red Material: Plastic Shape: Rectangular Fixing screw: 2 Numberplate light: w/ E-approval: Yes
NUMBERPLATE LAMPS LED				
171622 LED Numberplate Lamp		Std pkg 1		
		Voltage: 24	Dim.: 102x56x53 mm Dist. mount. holes: 72 mm	Type: LED Illumination of numberplate Colour: Black Colour/glass: Transparent Shape: Rectangular Numberplate light: w/ No./LEDs: 4 E-approval: Yes
171624 LED Numberplate Lamp		Std pkg 1		
		Voltage: 24	Dim.: 102x56x53 mm Dist. mount. holes: 73 mm	Type: LED Illumination of numberplate Colour: Black Colour/glass: Red Shape: Rectangular Numberplate light: w/ LEDs: w/ E-approval: Yes

		EL. SPECIFICATIONS	DIMENSIONS	ADDITIONAL SPECIFICATIONS
171709	LED Numberplate Lamp Std pkg 1		Voltage: 12/24 Dim.: 109x61x55.5 mm Dist. mount. holes: 85.5 mm	Type: LED Illumination of numberplate Socket type: LED Colour: Red Material: Shockproof plastic Shape: Rectangular Fixing screw: 2 Numberplate light: w/ E-approval: Yes
171714	LED Numberplate Lamp Std pkg 1			
171715	LED Numberplate Lamp Std pkg 1		Voltage: 12/24 Dim.: 82.5x39x31 mm Dist. mount. holes: 44 mm	Type: LED Illumination of numberplate Socket type: LED Colour/glass: Red Material: Shockproof plastic Shape: Rectangular Fixing screw: 2 Numberplate light: w/ Tightness norm: IP 68 E-approval: Yes
171716	LED Numberplate Lamp Std pkg 1			
171737	LED Numberplate Lamp Std pkg 1		Voltage: 12 Watt: 0.3 Dim.: 75x29x34 mm Cable length: 300 mm Dist. mount. holes: 65 mm	Type: LED Illumination of numberplate Connection: Cable Shape: Rectangular Mount.: 2 screws Numberplate light: w/ No./LEDs: 3 E-approval: Yes
171738	LED Numberplate Lamp Std pkg 1			
171824	LED Numberplate Lamp Std pkg 1		Voltage: 12/24 Watt: 0.5-1.1 Dim.: 100x58.5x55.8 mm Cable length: 1000 mm Dist. mount. holes: 72 mm	Type: LED Illumination of numberplate Colour: Black Colour/glass: White Material: Plastic Shape: Rectangular Fixing screw: 2 Numberplate light: w/ No./LEDs: 2 E-approval: Yes

172002 LED Numberplate Lamp Std pkg 1

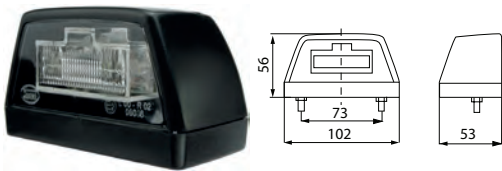

Voltage: 12

Dim.: 102x56x53 mm
Dist. mount. holes:
73 mm

Type: LED Illumination of numberplate
Colour: Black
Colour/glass: Transparent
Material: Plastic
Shape: Rectangular
Numberplate light: w/
No./LEDs: 4
E-approval: Yes

172009 LED Numberplate Lamp Std pkg 1

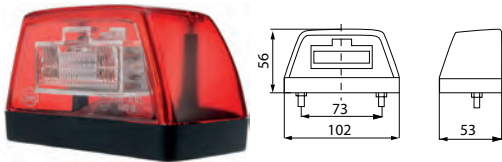

Voltage: 12

Dim.: 102x56x53 mm
Dist. mount. holes:
73 mm

Type: LED Illumination of numberplate
Colour: Black
Colour/glass: Red
Shape: Rectangular
Numberplate light: w/
LEDs: w/
E-approval: Yes

TAIL-LIFT LAMPS CONVENTIONAL

170746 Tail Lift Lamp Set Std pkg 1

Set of cables, connectors and mounting screws. Incl. 12/24 V relay.

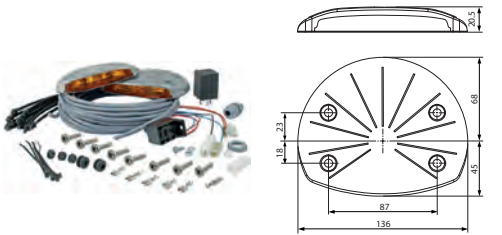

Bulb incl.: Yes
Voltage: 24

Dim.: 136x113x20.5 mm
Dist. mount. holes:
87 mm

Material: Cast aluminum
Approval: GGVS/ADR

170748 Tail Lift Lamp Std pkg 1

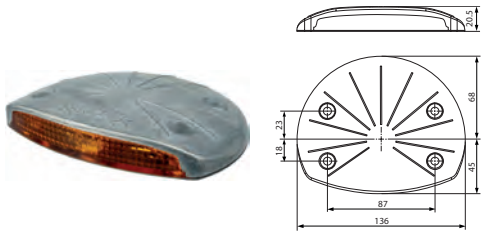

Bulb incl.: Yes
Voltage: 24

Dim.: 136x113x20.5 mm
Dist. mount. holes:
87 mm

Material: Cast aluminum
Approval: GGVS/ADR
E-approval: Yes

TAIL-LIFT LAMPS LED

171621 LED Tail Lift Lamp Std pkg 1

Dust and waterproof.

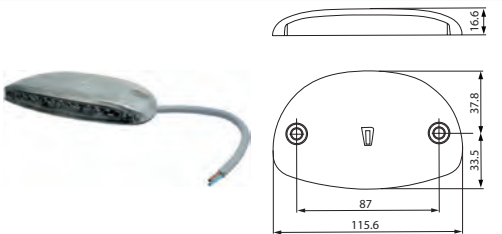

Voltage: 24

Dim.: 115x71.3x16.6 mm
Dist. mount. holes:
87 mm

Type: LED Tail lamp
Colour: Orange
Material: Alu/zinc
No./LEDs: 12
Approval: GGVS/ADR

TRAILER LIGHTING SETS

170809 Trailer Lighting Set Std pkg 1

Light construction. 7-pole plug. Multi Function Lamp: HC-CARGO 170939.

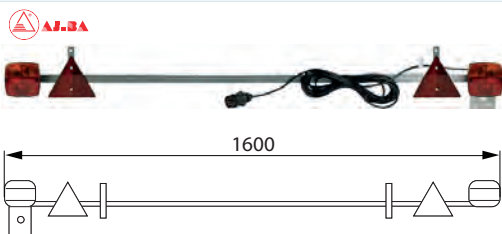

Bulb incl.: Yes
Voltage: 12

Dim.: 1600 mm
Cable length: 7500 mm

Connection: Cable
Material: Galvanized steel
No./lamps: 2
No./reflectors: 2
Flasher light: w/
Numberplate holder: w/
Stop light: w/

170828 Front/rear lighting set Std pkg 1

7-pole plug. Tail-stop-flash lamp: HC-CARGO 170939. Flash-position lamp: HC-CARGO 170941. Magnet w/ metal bracket: HC-CARGO 170942.



Bulb incl.: Yes
Voltage: 12

Dim.: 107x100 mm
Cable length:
4500/7500 mm

Connection: Cable
Shape: Square
Mount.: Magnetic
No./lamps: 2
Flasher light: w/
Sidemarker: w/
Tail light: w/
Stop light: w/

170829 Number Plate Holder Std pkg 1

7-pole plug. Multi Function Lamp: HC-CARGO 170939, 170940.

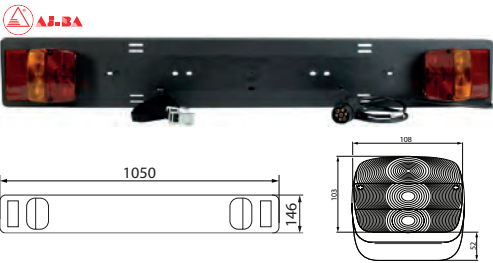

Bulb incl.: Yes
Voltage: 12

Dim.: 1050x146 mm
Cable length: 1500 mm

Reflector: w/
Numberplate holder: w/
Straps incl.: Yes

170835 Trailer Lighting Set Std pkg 1

Light construction. 7-pole plug. Multi Function Lamp: HC-CARGO 170939.

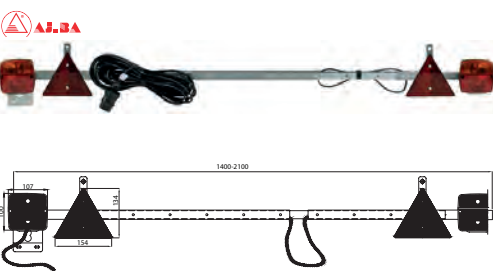

Bulb incl.: Yes
Voltage: 12

Dim.: 1400-2100 mm
Cable length:
12000 mm

Material: Galvanized steel
No./lamps: 2
No./reflectors: 2
Flasher light: w/
Numberplate holder: w/
Numberplate light: w/o
Rear/fog lamp: w/o
Reverse light: w/o
Sidemarker: w/o
Sidemarker lamp: w/o
Tail light: w/
Stop light: w/
Width/adjustable: w/

171049 Trailer Lighting Set Std pkg 1

Extensible light construction. 7-pole plug. Multi Function Lamp: HC-CARGO 170939.

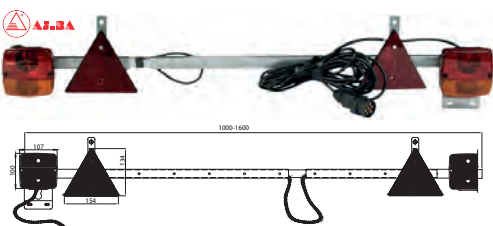

Bulb incl.: Yes
Voltage: 12

Dim.: 1000-1600 mm
Cable length: 7500 mm

Connection: Terminal
Material: Galvanized steel
No./lamps: 2
No./reflectors: 2
Flasher light: w/
Numberplate holder: w/
Tail light: w/
Stop light: w/
Width/adjustable: w/

171818 Trailer lighting set Std pkg 1

Lens: HC-CARGO 171833, 171834. Lamp: HC-CARGO 171870, 171871. Multi Connector: HC-CARGO 171372, 171373.

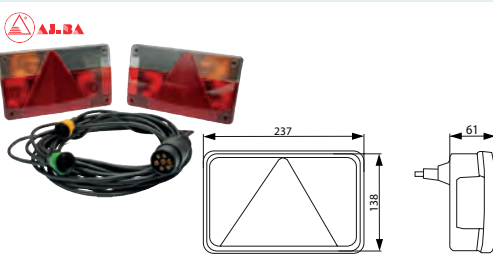

Bulb incl.: Yes
Voltage: 12

Dim.: 237x138x61 mm
Cable length:
2x5000 mm

Connection: Multiplug
Shape: Rectangular
No./lamps: 2
Flasher light: w/
Numberplate light: w/
Rear/fog lamp: w/
Reverse light: w/o
Sidemarker: w/o
Sidemarker lamp: w/o
Tail light: w/
Stop light: w/
E-approval: Yes

171821 Trailer lighting set Std pkg 1

Multi connector: HC-CARGO 171372, 171373. Lens: HC-CARGO 170833. Light: HC-CARGO 171822.

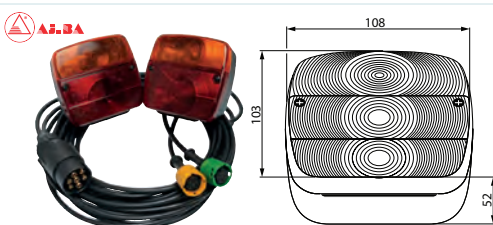







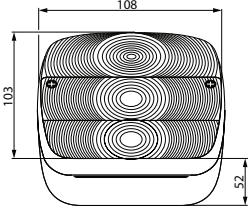

Bulb incl.: Yes
Voltage: 12

Dim.: 108x103x52 mm
Cable length:
2x5000 mm

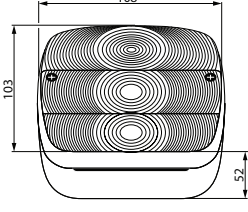
Connection: Multiplug
Shape: Square
Flasher light: w/
Numberplate light: w/o
Tail light: w/
Stop light: w/
E-approval: Yes

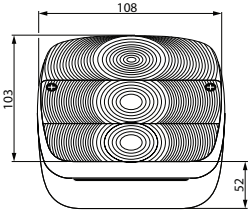
171872 Trailer lighting set		Std pkg 1	
<p>Lens: HC-CARGO 171833, 171834. Lamp: HC-CARGO 171870, 171871.</p>			
	<p>Bulb incl.: Yes Voltage: 12</p>	<p>Dim.: 237x138x61 mm Cable length: 2x7500 mm</p>	<p>Connection: Multiplug Shape: Rectangular No./lamps: 2 Flasher light: w/ Numberplate light: w/ Rear/fog lamp: w/ Reverse light: w/o Sidemarker: w/o Sidemarker lamp: w/o Tail light: w/ Stop light: w/ E-approval: Yes</p>
<p>171873 Trailer lighting set</p>		<p>Std pkg 1</p>	
<p>Multi connector: HC-CARGO 171372, 171373. Lens: HC-CARGO 170833.</p>			
	<p>Bulb incl.: Yes Voltage: 12</p>	<p>Dim.: 108x103x52 mm Cable length: 2x7500 mm</p>	<p>Connection: Multiplug Shape: Square Flasher light: w/ Numberplate light: w/ Tail light: w/ Stop light: w/ E-approval: Yes</p>
<p>171935 Trailer Lighting Set</p>		<p>Std pkg 1</p>	
<p>7-pole plug. Magnet w/ metalbracket: HC-CARGO 170942. Multi Function Lamp: HC-CARGO 170939.</p>			
	<p>Bulb incl.: Yes Voltage: 12</p>	<p>Dim.: 108x103x52 mm Cable length: 4000/13000 mm</p>	<p>Connection: Cable Mount.: Magnetic No./lamps: 2 Reflector: w/ Flasher light: w/ Tail light: w/ Stop light: w/</p>
<p>172216 LED Trailer lighting set</p>		<p>Std pkg 1</p>	
<p>w/ built-in resistor.</p>			
	<p>Voltage: 12</p>	<p>Dim.: 101.6x91.6x26 mm Cable length: 2x7500 mm Dist. mount. holes: 45 mm</p>	<p>Type: LED Multifunction Lamp Connection: Multiplug Shape: Square Mount.: 4 holes No./lamps: 2 Reflector: w/ Flasher light: w/ Numberplate light: w/ Tail light: w/ Stop light: w/ LEDs: w/ Tightness norm: IP 67 E-approval: Yes Alternativ no.: 172217</p>
<p>172217 LED Trailer lighting set</p>		<p>Std pkg 1</p>	
<p>w/ built-in resistor.</p>			
	<p>Voltage: 12</p>	<p>Dim.: 101.6x91.6x26 mm Cable length: 2x7500 mm</p>	<p>Type: LED Connection: Multiplug Shape: Square Mount.: Magnetic No./lamps: 2 Reflector: w/ Flasher light: w/ Numberplate light: w/ Tail light: w/ Stop light: w/ LEDs: w/ Tightness norm: IP 67 E-approval: Yes Alternativ no.: 172216</p>
<p>SPARE PARTS</p>			
<p>170833 Lens, Rear Lamp</p>		<p>Std pkg 1 Servicing: HC-CARGO 170939, 170940, 171821, 171822, 171873</p>	
		<p>Dim.: 108x103x52 mm</p>	<p>Material: Shockproof plastic Shape: Square Flasher light: w/ Numberplate light: w/o Rear/fog lamp: w/o Reverse light: w/o Sidemarker: w/o Sidemarker lamp: w/o Tail light: w/ Stop light: w/ RH/LH: RH/LH</p>

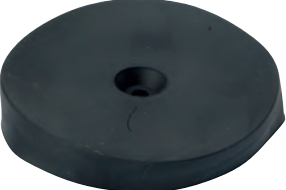
EL. SPECIFICATIONS		DIMENSIONS		ADDITIONAL SPECIFICATIONS	
170834 Lens, Rear Lamp Std pkg 1 Servicing: HC-CARGO 170941				Dim.: 108x103x52 mm	Shape: Square Fixing screw: 2 Flasher light: w/ Sidemarker: w/
170939 Multi Function Lamp Std pkg 1 Servicing: HC-CARGO 170809, 170828, 170829, 170835, 171049, 171935 Lens: HC-CARGO 170833.		 		Bulb incl.: No Watt: 21 Watt 2: 21/5 Dim.: 108x103x52 mm Dist. mount. holes: 45/55 mm	Socket type: BA15S Socket type 2: BAY15d Connection: Terminal Material: Shockproof plastic Shape: Square Fixing screw: 2 Flasher light: w/ Numberplate light: w/o Rear/fog lamp: w/o Reverse light: w/o Sidemarker: w/o Sidemarker lamp: w/o Tail light: w/ Stop light: w/ RH/LH: RH/LH E-approval: Yes
170940 Multi Function Lamp Std pkg 1 Servicing: HC-CARGO 170829 Lens: HC-CARGO 170833.		 		Bulb incl.: No Watt: 21 Watt 2: 21/5 Dim.: 108x103x52 mm Dist. mount. holes: 45/55 mm	Socket type: BA15S Socket type 2: BAY15d Connection: Terminal Material: Shockproof plastic Shape: Square Fixing screw: 2 Flasher light: w/ Numberplate light: w/ Rear/fog lamp: w/o Reverse light: w/o Sidemarker: w/o Sidemarker lamp: w/o Tail light: w/ Stop light: w/ RH/LH: RH/LH E-approval: Yes
170941 Flasher/Position Lamp Std pkg 1 Servicing: HC-CARGO 170828 Lens: HC-CARGO 170834.		 		Bulb incl.: No Watt: 21 Watt 2: 5 Dim.: 108x103x52 mm Dist. mount. holes: 55 mm	Socket type: BA15S Socket type 2: S8.5 Connection: Terminal Material: Shockproof plastic Shape: Square Fixing screw: 2 Flasher light: w/ Sidemarker: w/ RH/LH: RH/LH E-approval: Yes
170942 Magnet Std pkg 2 Servicing: HC-CARGO 170828, 171935 For camera. Rubber Protection: HC-CARGO 171795.				OD: 76 mm	
171795 Rubber Protection Std pkg 2 Servicing: HC-CARGO 170942				ID: 76 mm	Rubber: w/

171822 Multi Function Lamp Std pkg 1 Servicing: HC-CARGO 171821 <i>Multi connector: HC-CARGO 171372, 171373. Lens: HC-CARGO 170833.</i>				Bulb incl.: Yes Watt: 21 Watt 2: 21/5	Dim.: 108x103x52 mm Dist. mount. holes: 45/55 mm	Socket type: BA15S Socket type 2: BAY15d Connection: Multiplug Shape: Square Flasher light: w/ Numberplate light: w/o Rear/fog lamp: w/o Reverse light: w/o Sidemarker: w/ Sidemarker lamp: w/o Tail light: w/o Stop light: w/ E-approval: Yes
171833 Lens, Rear Lamp Std pkg 1 Servicing: HC-CARGO 171818, 171871, 171872					Dim.: 237x138x19 mm	Material: Shockproof plastic Shape: Rectangular Flasher light: w/ Numberplate light: w/ Rear/fog lamp: w/ Sidemarker: w/ Stop light: w/ RH/LH: RH E-approval: Yes
171834 Lens, Rear Lamp Std pkg 1 Servicing: HC-CARGO 171818, 171870, 171872					Dim.: 237x138x19 mm	Material: Shockproof plastic Shape: Rectangular Flasher light: w/ Numberplate light: w/ Rear/fog lamp: w/ Sidemarker: w/ Stop light: w/ RH/LH: LH E-approval: Yes
171870 Multi Function Lamp Std pkg 1 Servicing: HC-CARGO 171818, 171872 <i>Lens: HC-CARGO 171834. Multi connector: HC-CARGO 171537, 171538. Right: HC-CARGO 171871.</i>				Bulb incl.: Yes Voltage: 12	Dim.: 237x138x61 mm	Shape: Rectangular Flasher light: w/ Numberplate light: w/ Rear/fog lamp: w/ Reverse light: w/o Sidemarker: w/ Sidemarker lamp: w/o Tail light: w/o Stop light: w/ RH/LH: LH E-approval: Yes
171871 Multi Function Lamp Std pkg 1 Servicing: HC-CARGO 171818, 171872 <i>Lens: HC-CARGO 171833. Multi connector: HC-CARGO 171537, 171538. Left: HC-CARGO 171870.</i>				Bulb incl.: Yes Voltage: 12	Dim.: 237x138x61 mm	Shape: Rectangular Flasher light: w/ Numberplate light: w/ Rear/fog lamp: w/ Reverse light: w/o Sidemarker: w/ Sidemarker lamp: w/o Tail light: w/o Stop light: w/ RH/LH: RH E-approval: Yes
INTERIOR LAMPS CONVENTIONAL						
171356 Interior Lamp Std pkg 1				Bulb incl.: No Watt: 25	Dim.: 184.5x38.5 mm Dist. mount. holes: 138 mm	Socket type: BA15S Material: Plastic Shape: Circular

171428 Interior Lamp Std pkg 1

For build-in. Depth: 35 mm.

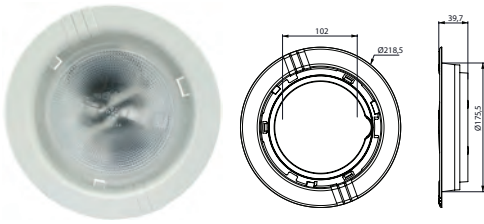

Bulb incl.: No
Watt: 25

Dim.: 218.5x39.7 mm
Dist. mount. holes:
180 mm

Socket type: BA15S
Material: Plastic
Shape: Circular

INTERIOR LAMPS LED

171676 LED Interior Lamp Std pkg 1

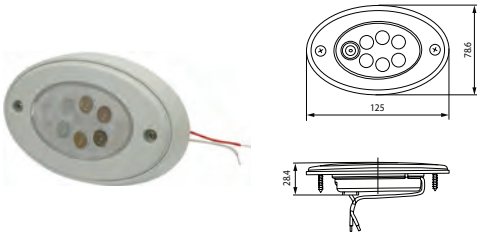

Voltage: 12/24
Watt: 0.7

Dim.: 125x78.6x28.4 mm
Cable length: 120 mm
Dist. mount. holes:
100 mm

Type: LED Interior lamp
Connection: Cable
Colour: White
Colour/glass: Frosted
Material: Shockproof plastic
Material/dome: PMMA
Shape: Oval
Switch: w/
No./LEDs: 6
Approval: CE/UL

171677 LED Interior Lamp Std pkg 1

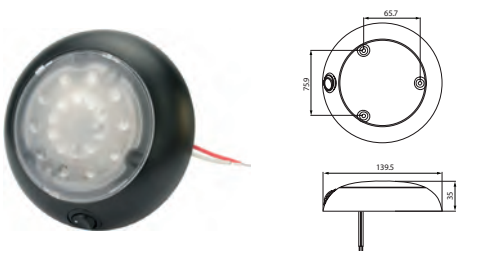

Voltage: 12/24
Watt: 1.5

Dim.: 139.5x35 mm
Cable length: 210 mm
Dist. mount. holes:
75 mm

Type: LED Interior lamp
Connection: Cable
Colour: Black
Colour/glass: Frosted
Material: Shockproof plastic
Material/dome: PMMA
Shape: Round
Mount.: Plan installation
Switch: w/
No./LEDs: 20
Approval: CE

171679 LED Interior Lamp Std pkg 1

180° adjustable.

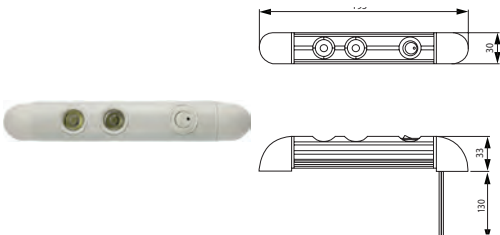

Voltage: 9-30
Watt: 3

Dim.: 195x30x33 mm
Cable length: 130 mm
Dist. mount. holes:
164 mm

Type: LED Interior lamp
Connection: Cable
Colour: White
Colour/glass: Transparent
Material: Alu/plastic
Material/dome: PMMA
Shape: Oblong
Switch: w/
No./LEDs: 2
Approval: CE

171695 LED Interior Lamp Std pkg 1

For flush mounting.

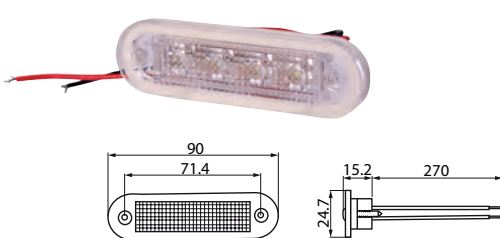

Voltage: 12/24

Dim.: 90x24.7 mm
Cable length: 270 mm
Dist. mount. holes:
71.4 mm

Type: LED Interior lamp
Connection: Cable
Colour: White
Colour/glass: Frosted
Material: Shockproof plastic
Material/dome: PMMA
Shape: Oval
Mount.: Plan installation
No./LEDs: 4
Tightness norm: IP 66
Approval: CE

171696 LED Interior Lamp Std pkg 1

For flush mounting.

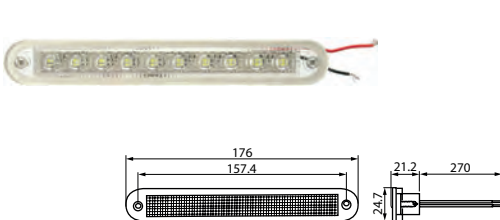







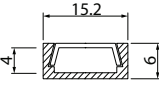
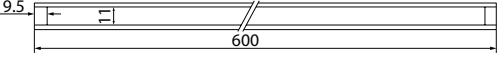

Voltage: 12/24
Watt: 0.8

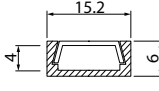
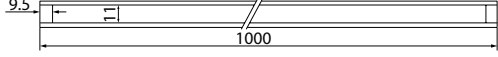

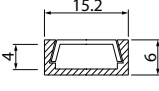
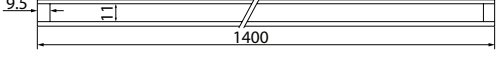
Dim.: 176x24.7x21.2 mm
Cable length: 270 mm
Dist. mount. holes:
157.4 mm

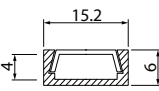
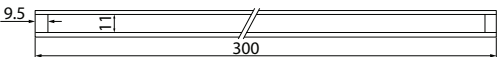
Type: LED Interior lamp
Connection: Cable
Colour: White
Colour/glass: Frosted
Material: Shockproof plastic
Material/dome: PMMA
Shape: Oval
Mount.: Plan installation
No./LEDs: 10
Tightness norm: IP 66
Approval: CE

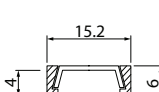
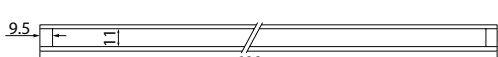

		EL. SPECIFICATIONS	DIMENSIONS	ADDITIONAL SPECIFICATIONS
171750	LED Interior Lamp	Std pkg 1		
		Voltage: 12/24 Lumen: 550	Dim.: 177x15.7 mm Cable length: 180 mm Dist. mount. holes: 140 mm	Type: LED Interior lamp Connection: Cable Colour: Chrome Colour/glass: Frosted Material: Shockproof plastic Material/dome: PMMA Shape: Round Mount.: Plan installation No./LEDs: 39 Tightness norm: IP 56
171767	LED Interior Lamp	Std pkg 1		
		Voltage: 9-30 Watt: 0.8	Dim.: 75x16 mm Cable length: 120 mm Dist. mount. holes: 53 mm	Type: LED Interior lamp Connection: Cable Colour: White Colour/glass: Transparent Material: Shockproof plastic Material/dome: PMMA Shape: Round Mount.: Built-in/Plan installation Switch: w/ No./LEDs: 1 Approval: CE
171769	LED Reading lamp	Std pkg 1		
		Voltage: 9-30 Watt: 1.8	Dim.: 150 mm Cable length: 120 mm Dist. mount. holes: 25 mm	Type: LED Interior lamp Connection: Cable Colour: Black Colour/glass: Frosted Material: ABS plastic/aluminium Material/dome: Polycarbonate Shape: w/ adjustable metal arm Mount.: 2 screws Switch: w/ No./LEDs: 1 Approval: CE
171773	LED Interior Lamp HD	Std pkg 1	Servicing: Suitable for use in refrigeration vehicles - Visit our web catalogue for further information	
		Voltage: 10-32 Watt: 8/9	Dim.: 200x27 mm Dist. mount. holes: 137 mm	Type: LED Interior lamp Connection: Cable Colour: White Colour/glass: Transparent Material: Cast aluminum Material/dome: Polycarbonate Shape: Round Mount.: Built-in/Plan installation No./LEDs: 6 Tightness norm: IP 67 Approval: EMC/ADR/GGVS
171776	LED Interior Lamp	Std pkg 1		
		Voltage: 12/24	Dim.: 145x28.5 mm Cable length: 220 mm Dist. mount. holes: 123 mm	Type: LED Interior lamp Connection: Cable Colour: Silver Colour/glass: Frosted Material: Shockproof plastic Material/dome: Shockproof plastic Shape: Round Mount.: Plan installation No./LEDs: 42 Tightness norm: IP 66 Approval: CE
171825	LED Interior Lamp	Std pkg 1		
		Voltage: 24 Watt: 2.2 Kelvin: 6500 Lumen: 80	Dim.: 300x15.2x6 mm Cable length: 400 mm	Type: LED Interior lamp Connection: Cable Colour: Grey Colour/glass: Transparent Material: Aluminium Material/dome: Polycarbonate Shape: Flat Mount.: Plan installation Bracket: Snap-on Fixing screw: w/ No./LEDs: 12 Tightness norm: IP 65 Approval: CE

171826 LED Interior Lamp		Std pkg 1			
	Voltage: 24 Watt: 4.3 Kelvin: 6500 Lumen: 160		Dim.: 600x15.2x6 mm Cable length: 400 mm	Type: LED Interior lamp Connection: Cable Colour: Grey Colour/glass: Transparent Material: Aluminium Material/dome: Polycarbonate Shape: Flat Mount.: Plan installation Bracket: Snap-on Fixing screw: w/ No./LEDs: 24 Tightness norm: IP 65 Approval: CE	
171827 LED Interior Lamp 24V		Std pkg 1			
	Voltage: 24 Watt: 7.5 Kelvin: 6500 Lumen: 281		Dim.: 1000x15.2x6 mm Cable length: 400 mm	Type: LED Interior lamp Connection: Cable Colour: Grey Colour/glass: Transparent Material: Aluminium Material/dome: Polycarbonate Shape: Flat Mount.: Plan installation Bracket: Snap-on Fixing screw: w/ No./LEDs: 42 Tightness norm: IP 65 Approval: CE	
171828 LED Interior Lamp		Std pkg 1			
	Voltage: 24 Watt: 10.8 Kelvin: 6500 Lumen: 394		Dim.: 1400x15.2x6 mm Cable length: 400 mm	Type: LED Interior lamp Connection: Cable Colour: Grey Colour/glass: Transparent Material: Aluminium Material/dome: Polycarbonate Shape: Flat Mount.: Plan installation Bracket: Snap-on Fixing screw: w/ No./LEDs: 60 Tightness norm: IP 65 Approval: CE	
171829 LED Interior Lamp		Std pkg 1			
	Voltage: 12 Watt: 2.2 Kelvin: 6500 Lumen: 80		Dim.: 300x15.2x6 mm Cable length: 400 mm	Type: LED Interior lamp Connection: Cable Colour: Grey Colour/glass: Transparent Material: Aluminium Material/dome: Polycarbonate Shape: Flat Mount.: Plan installation Bracket: Snap-on Fixing screw: w/ No./LEDs: 12 Tightness norm: IP 65 Approval: CE	
171830 LED Interior Lamp		Std pkg 1			
	Voltage: 12 Watt: 4.3 Kelvin: 6500 Lumen: 160		Dim.: 600x15.2x6 mm Cable length: 400 mm	Type: LED Interior lamp Connection: Cable Colour: Grey Colour/glass: Transparent Material: Aluminium Material/dome: Polycarbonate Shape: Flat Mount.: Plan installation Bracket: Snap-on Fixing screw: w/ No./LEDs: 24 Tightness norm: IP 65 Approval: CE	

		EL. SPECIFICATIONS	DIMENSIONS	ADDITIONAL SPECIFICATIONS
171831	LED Interior Lamp	Std pkg 1		
	Voltage: 12 Watt: 7.5 Kelvin: 6500 Lumen: 281	Dim.: 1000x15.2x6 mm Cable length: 400 mm	Type: LED Interior lamp Connection: Cable Colour: Grey Colour/glass: Transparent Material: Aluminium Material/dome: Polycarbonate Shape: Flat Mount.: Plan installation Bracket: Snap-on Fixing screw: w/ No./LEDs: 42 Tightness norm: IP 65 Approval: CE	
171832	LED Interior Lamp	Std pkg 1		
	Voltage: 12 Watt: 10.8 Kelvin: 6500 Lumen: 394	Dim.: 1400x15.2x6 mm Cable length: 400 mm	Type: LED Interior lamp Connection: Cable Colour: Grey Colour/glass: Transparent Material: Aluminium Material/dome: Polycarbonate Shape: Flat Mount.: Plan installation Bracket: Snap-on Fixing screw: w/ No./LEDs: 60 Tightness norm: IP 65 Approval: CE	
171863	LED Interior Lamp	Std pkg 1		
	Voltage: 12/24 Watt: 22 Lumen: 1100	Dim.: 465x150x21.7 mm Cable length: 420 mm	Type: LED Interior lamp Connection: Cable Colour: White Colour/glass: Frosted Material: Shockproof plastic Material/dome: PMMA Shape: Rectangular Mount.: Built-in No./LEDs: 12 Tightness norm: IP 67 Approval: CE	
171864	LED Interior Lamp	Std pkg 1		
	Voltage: 12/24 Watt: 22 Lumen: 1100	Dim.: 485.1x170.1x21.7 mm Cable length: 420 mm	Type: LED Interior lamp Connection: Cable Colour: White Colour/glass: Frosted Material: Shockproof plastic Material/dome: PMMA Shape: Rectangular Mount.: Plan installation No./LEDs: 12 Tightness norm: IP 67 Approval: CE	
171866	LED Interior Lamp	Std pkg 1		
	Voltage: 12/24 Lumen: 210	Dim.: 130x57x19 mm Cable length: 150 mm Dist. mount. holes: 46x121 mm	Type: LED Interior lamp Connection: Cable Colour: Transparent Colour/glass: Frosted Material: Shockproof plastic Material/dome: PMMA Shape: Rectangular Mount.: Plan installation Fixing screw: 4 No./LEDs: 10 Tightness norm: IP 67 Approval: CE	
171874	LED Interior Lamp	Std pkg 1		
	Voltage: 10-33 Watt: 1.6-3.4 Lumen: 82	Dim.: 300x19x19 mm Cable length: 400 mm	Type: LED Interior lamp Connection: Cable Colour: Grey Colour/glass: Transparent Material: Aluminium Material/dome: Polycarbonate Shape: Angled Mount.: Plan installation Bracket: Snap-on No./LEDs: 12 Tightness norm: IP 65 Approval: CE	

<p>171875 LED Interior Lamp Std pkg 1</p> 	<p>Voltage: 10-30 Watt: 3.2-6.8 Lumen: 166</p>	<p>Dim.: 600x19x19 mm Cable length: 400 mm</p>	<p>Type: LED Interior lamp Connection: Cable Colour: Grey Colour/glass: Transparent Material: Aluminium Material/dome: Polycarbonate Shape: Angled Mount.: Plan installation Bracket: Snap-on No./LEDs: 24 Tightness norm: IP 65 Approval: CE</p>
<p>171876 LED Interior Lamp Std pkg 1</p> 	<p>Voltage: 10-30 Watt: 5.7-11.8 Lumen: 273</p>	<p>Dim.: 1000x19x19 mm Cable length: 400 mm</p>	<p>Type: LED Interior lamp Connection: Cable Colour: Grey Colour/glass: Transparent Material: Aluminium Material/dome: Polycarbonate Shape: Angled Mount.: Plan installation Bracket: Snap-on No./LEDs: 42 Tightness norm: IP 65 Approval: CE</p>
<p>171877 LED Interior Lamp Std pkg 1</p> 	<p>Voltage: 10-30 Watt: 8.1-16.8 Lumen: 383</p>	<p>Dim.: 1400x19x19 mm Cable length: 400 mm</p>	<p>Type: LED Interior lamp Connection: Cable Colour: Grey Colour/glass: Transparent Material: Aluminium Material/dome: Polycarbonate Shape: Angled Mount.: Plan installation Bracket: Snap-on No./LEDs: 60 Tightness norm: IP 65 Approval: CE</p>

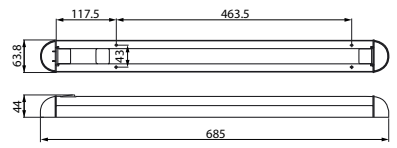
INTERIOR LAMPS FLOURESCENT

<p>170033 Interior Lamp Std pkg 1</p>			
<p><i>Tube fluorescent: HC-CARGO 171397.</i></p>			
 	<p>Voltage: 24 Watt: 13</p>	<p>Dim.: 685x63.8x44 mm Dist. mount. holes: 590 mm</p>	<p>Colour: White Material: ABS plastic/aluminium Shape: Oblong Switch: w/ Fixing screw: 2 Tightness norm: IP 40 Approval: CE</p>
<p>171392 Interior Lamp Std pkg 1</p>			
<p><i>w/ switch 0-1-2. Tube: HC-CARGO 170664.</i></p>			
	<p>Voltage: 12 Watt: 2x8</p>	<p>Dim.: 360x62x37 mm Dist. mount. holes: 200 mm</p>	<p>Colour: White Material: Plastic Shape: Rectangular Switch: w/ Fixing screw: 2</p>
<p>171396 Interior Lamp Std pkg 1</p>			
<p><i>Tube fluorescent: HC-CARGO 171397.</i></p>			
	<p>Voltage: 24 Watt: 13</p>	<p>Dim.: 580x50x26 mm Dist. mount. holes: 465 mm</p>	<p>Colour: White Material: Plastic Shape: Rectangular Switch: w/ Fixing screw: 2</p>

SPARE PARTS
170664 Neon tube Std pkg 1 Servicing: HC-CARGO 170035, 170036, 171392, 200181

 Voltage: 12-24
Watt: 8

Length: 300 mm

E-approval: No

REFLECTORS
170142 Reflector Std pkg 10

w/ 5 mm bolt.



OD: 60 mm

 Colour: Red
Material: Plastic
Shape: Round
Approval: I A approval
E-approval: Yes

170143 Reflector Std pkg 10

w/ 5 mm bolt.



OD: 83 mm

 Colour: Red
Material: Plastic
Shape: Round
Approval: I A approval
E-approval: Yes

170144 Reflector Std pkg 10

 Dim.: 160x160x160 mm
Dist. mount. holes:
85 mm

 Colour: Red
Material: Plastic
Shape: Triangle
Mount.: 2 screws
Approval: III A approval
E-approval: Yes

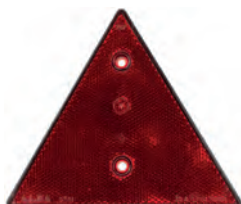
170163 Reflector Std pkg 10

 Dim.: 155x135 mm
Dist. mount. holes:
70 mm

 Colour: Red
Material: Plastic
Shape: Triangle
Mount.: 2 holes
Approval: III A approval
E-approval: Yes



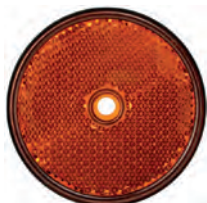

170165 Reflector Std pkg 10









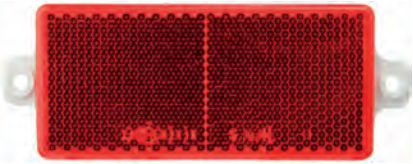
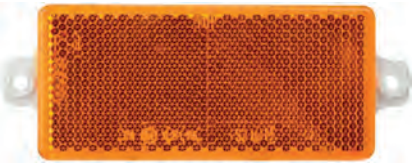
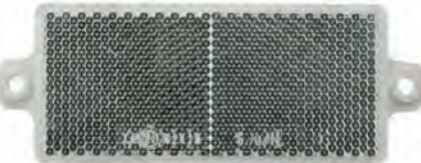

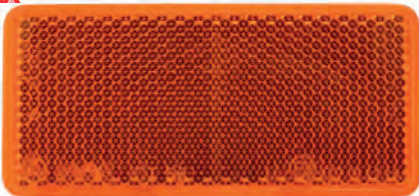

 OD: 60 mm
Hole size: 4 mm

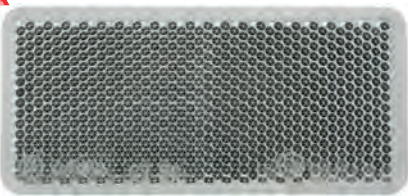



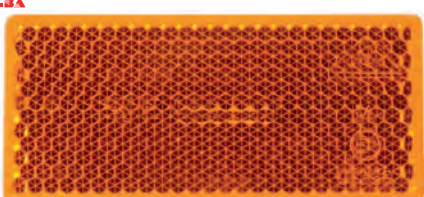

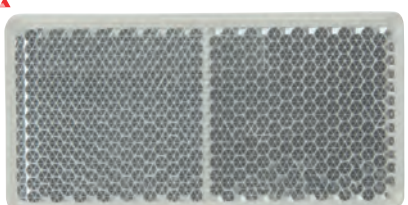

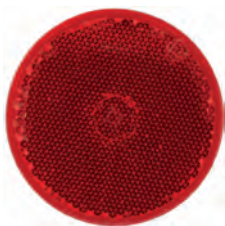
 Colour: Red
Material: Plastic
Shape: Round
Approval: I A approval
E-approval: Yes

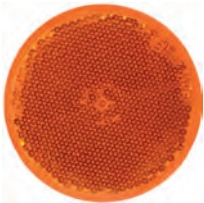

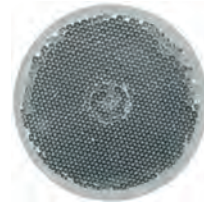

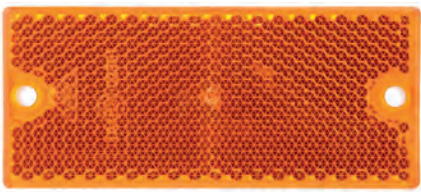

170169 Reflector Std pkg 10

 OD: 60 mm
Hole size: 4 mm

 Colour: Orange
Material: Plastic
Shape: Round
Approval: I A approval
E-approval: Yes

EL. SPECIFICATIONS		DIMENSIONS	ADDITIONAL SPECIFICATIONS
170170 Reflector	Std pkg 10		
		OD: 60 mm Hole size: 4 mm	Colour: White Material: Plastic Shape: Round Approval: I A approval E-approval: Yes
170208 Reflector	Std pkg 10		
<i>Only approved in DK.</i>			
		Dim.: 50x200 mm	Colour: Red Shape: Rectangular Mount.: Self adhesive Approval: JRU E-approval: No
170212 Reflector	Std pkg 10		
<i>Only approved in DK.</i>			
		Dim.: 50x200 mm	Colour: White Shape: Rectangular Mount.: Self adhesive E-approval: No
170213 Reflector	Std pkg 10		
<i>Only approved in DK.</i>			
		Dim.: 50x200 mm	Colour: Yellow Shape: Rectangular Mount.: Self adhesive Approval: JRU E-approval: No
170623 Reflector	Std pkg 10		
		Dim.: 95x44 mm Dist. mount. holes: 105 mm	Colour: Red Material: Plastic Shape: Rectangular Mount.: 2 holes Approval: I A approval E-approval: Yes
170624 Reflector	Std pkg 10		
		Dim.: 95x44 mm Dist. mount. holes: 105 mm	Colour: Orange Material: Plastic Shape: Rectangular Mount.: 2 holes Approval: I A approval E-approval: Yes
170625 Reflector	Std pkg 10		
		Dim.: 95x44 mm Dist. mount. holes: 105 mm	Colour: White Material: Plastic Shape: Rectangular Mount.: 2 holes Approval: I A approval E-approval: Yes



EL. SPECIFICATIONS		DIMENSIONS	ADDITIONAL SPECIFICATIONS
170626 Reflector	Std pkg 10		
 		Dim.: 95x44 mm	Colour: Red Material: Plastic Shape: Rectangular Mount.: Self adhesive Approval: I A approval E-approval: Yes
170627 Reflector	Std pkg 10		
 		Dim.: 95x44 mm	Colour: Orange Material: Plastic Shape: Rectangular Mount.: Self adhesive Approval: I A approval E-approval: Yes
170628 Reflector	Std pkg 10		
 		Dim.: 95x44 mm	Colour: White Material: Plastic Shape: Rectangular Mount.: Self adhesive Approval: I A approval E-approval: Yes
170629 Reflector	Std pkg 10		
 		Dim.: 71x35 mm	Colour: Red Material: Plastic Shape: Rectangular Mount.: Self adhesive Approval: I A approval E-approval: Yes
170630 Reflector	Std pkg 10		
 		Dim.: 71x35 mm	Colour: Orange Material: Plastic Shape: Rectangular Mount.: Self adhesive Approval: I A approval E-approval: Yes
170631 Reflector	Std pkg 10		
 		Dim.: 71x35 mm	Colour: White Material: Plastic Shape: Rectangular Mount.: Self adhesive Approval: I A approval E-approval: Yes
170675 Reflector	Std pkg 10		
 		OD: 60 mm	Colour: Red Material: Plastic Shape: Round Mount.: Self adhesive Approval: I A approval E-approval: Yes







		EL. SPECIFICATIONS	DIMENSIONS	ADDITIONAL SPECIFICATIONS
170676	Reflector	Std pkg 10		
			OD: 60 mm	Colour: Orange Material: Plastic Shape: Round Mount.: Self adhesive Approval: I A approval E-approval: Yes
170677	Reflector	Std pkg 10		
			OD: 60 mm	Colour: White Material: Plastic Shape: Round Mount.: Self adhesive Approval: I A approval E-approval: Yes
170729	Reflector Red	Std pkg 10		
			OD: 83 mm Hole size: 4 mm	Colour: Red Material: Plastic Shape: Round Mount.: 1 hole Approval: I A approval E-approval: Yes
171230	Reflector	Std pkg 10	Servicing: Mercedes-Benz - Visit our web catalogue for further information	
			Dim.: 90x40 mm Dist. mount. holes: 79 mm	Colour: Orange Material: Plastic Shape: Rectangular Mount.: 2 holes Approval: I A approval E-approval: Yes
ACCESSORIES				
171536	Bracket	Std pkg 1		
			ID: 60 mm	No./mounting holes: 1 (0)
MISCELLANEOUS REAR MARKING				
171883	Green Identifying Marker	Std pkg 1		
<i>Silenced.</i>				
			OD: 200 mm	Colour: White/green Material: PVC Film Shape: Round Mount.: Self adhesive
171884	Green Identifying Marker	Std pkg 1		
<i>Silenced.</i>				
			OD: 200 mm	Colour: White/green Material: PVC Film Shape: Round Mount.: Self adhesive

EL. SPECIFICATIONS		DIMENSIONS	ADDITIONAL SPECIFICATIONS
171885 Green Identifying Marker Std pkg 1			
<i>Reduced emissions.</i>			
		OD: 200 mm	Colour: White/green Material: PVC Film Shape: Round Mount.: Self adhesive
171886 Green Identifying Marker Std pkg 1			
<i>Silenced. Reduced emissions.</i>			
		OD: 200 mm	Colour: White/green Material: PVC Film Shape: Round Mount.: Self adhesive
171887 EURO 3 Std pkg 1			
		OD: 200 mm	Colour: White/green Material: PVC Film Shape: Round Mount.: Self adhesive
171888 EURO 3 Std pkg 1			
		OD: 200 mm	Colour: White/green Material: PVC Film Shape: Round Mount.: Self adhesive
171889 EURO 3 Std pkg 1			
		OD: 200 mm	Colour: White/green Material: PVC Film Shape: Round Mount.: Self adhesive
SPEED LIMIT			
171898 Max Speedsign 15 km Std pkg 1			
<i>Self-adhesive. Class 2.</i>			
		OD: 200 mm	Material: Film Shape: Round
171899 Max Speedsign 40 km Std pkg 1			
<i>Self-adhesive. Class 2.</i>			
		OD: 200 mm	Material: Film Shape: Round

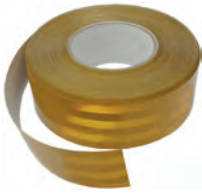
171900 Max Speedsign 60 km Std pkg 1 Self-adhesive. Class 2.			
		OD: 200 mm	Material: Film Shape: Round
171901 Max Speedsign 70 km Std pkg 1 Self-adhesive. Class 2.			
		OD: 200 mm	Material: Film Shape: Round
171902 Max Speedsign 80 km Std pkg 1 Self-adhesive. Class 2.			
		OD: 200 mm	Material: Film Shape: Round
171903 Max Speedsign 100 km Std pkg 1 Self-adhesive. Class 2.			
		OD: 200 mm	Material: Film Shape: Round

REAR MARKING TRAILERS

170397 Reflector Board Std pkg 1 Yellow: high intensive reflex. Class - A. Red: fluorescent.			
		Dim.: 1132x200 mm	Colour: Red/yellow Material: Aluminium Shape: Rectangular Approval: ECE70 E-approval: Yes
170398 Reflector Board Set Std pkg 1 Yellow: high intensive reflex. Class - A. Red: fluorescent. 2 pcs.			
		Dim.: 566x200 mm	Colour: Red/yellow Material: Aluminium Shape: Rectangular Approval: ECE70 E-approval: Yes
170403 Reflector Foil Set Std pkg 1 Yellow: high intensive reflex. Class - A. Red: fluorescent. 2 pcs.			
		Dim.: 566x200 mm	Colour: Red/yellow Shape: Rectangular Mount.: Self adhesive Approval: ECE70 E-approval: Yes

EL. SPECIFICATIONS		DIMENSIONS	ADDITIONAL SPECIFICATIONS
171554 Reflector Tape 50 m Std pkg 1			
<i>Safety marking for heavy vehicles and trailers. Mounting on rigid surface.</i>			
		Width: 50 mm	Colour: Yellow Mount.: Self adhesive Approval: ECE104 E-approval: Yes
171555 Reflector Tape 50 m Std pkg 1			
<i>Safety marking for heavy vehicles and trailers. Mounting on rigid surface.</i>			
		Width: 50 mm	Colour: White Mount.: Self adhesive Approval: ECE104 E-approval: Yes
171556 Reflector Tape 50 m Std pkg 1			
<i>Safety marking for heavy vehicles and trailers. Mounting on rigid surface.</i>			
		Width: 50 mm	Colour: Red Mount.: Self adhesive Approval: ECE104 E-approval: Yes
171570 Reflector Board Set Std pkg 1			
<i>Yellow: high intensitive reflex. Class 3. Red: fluorescent. 2 pcs.</i>			
		Dim.: 566x197x0.8 mm	Colour: Red/yellow Material: Aluminium Shape: Rectangular Approval: ECE70-01 E-approval: Yes
171572 Reflector Foil Set Std pkg 1			
<i>Yellow: high intensitive reflex. Class 3. Red: fluorescent. 2 pcs.</i>			
		Dim.: 566x197 mm	Colour: Red/yellow Shape: Rectangular Mount.: Self adhesive Approval: ECE70-01 E-approval: Yes
REAR MARKING TRUCKS			
170394 Reflector Board Std pkg 1			
<i>Yellow: high intensitive reflex. Class II. Red: fluorescent. 1 pcs.</i>			
		Dim.: 1132x140x1.2 mm	Colour: Red/yellow Material: Aluminium Shape: Rectangular Approval: ECE70 E-approval: Yes
170395 Reflector Board Set Std pkg 1			
<i>Yellow: high intensitive reflex. Class II. Red: fluorescent. 2 pcs.</i>			
		Dim.: 565x132x0.8 mm	Colour: Red/yellow Material: Aluminium Shape: Rectangular Approval: ECE70 E-approval: Yes

EL. SPECIFICATIONS		DIMENSIONS	ADDITIONAL SPECIFICATIONS
170396 Reflector Board Set Std pkg 1 <i>Yellow: high intensive reflex. Class II. Red: fluorescent. 4 pcs.</i>			
		Dim.: 283x140x0.8 mm	Colour: Red/yellow Material: Aluminium Shape: Rectangular Approval: ECE70 E-approval: Yes
170401 Reflector Foil Set Std pkg 1 <i>Yellow: high intensive reflex. Class II. Red: fluorescent. 2 pcs.</i>			
		Dim.: 566x140 mm	Colour: Red/yellow Shape: Rectangular Mount.: Self adhesive Approval: ECE70 E-approval: Yes
170402 Reflector Foil Set Std pkg 1 <i>Yellow: high intensive reflex. Class II. Red: fluorescent. 4 pcs.</i>			
		Dim.: 283x140 mm	Colour: Red/yellow Shape: Rectangular Mount.: Self adhesive Approval: ECE70 E-approval: Yes
171568 Reflector Board Set Std pkg 1 <i>Yellow: high intensive reflex. Class 3. Red: fluorescent. 2 pcs.</i>			
		Dim.: 565x132x0.8 mm	Colour: Red/yellow Material: Aluminium Shape: Rectangular Approval: ECE70-01 E-approval: Yes
171571 Reflector Foil Set Std pkg 1 <i>Yellow: high intensive reflex. Class 3. Red: fluorescent. 2 pcs.</i>			
		Dim.: 566x132 mm	Colour: Red/yellow Shape: Rectangular Mount.: Self adhesive Approval: ECE70-01 E-approval: Yes
171878 Warning Liftflag Right Std pkg 1 <i>Right. Class 1.</i>			
		Dim.: 410x250 mm	Colour: Red/white Material: Canvas + film Shape: Rectangular
171879 Warning Liftflag Std pkg 1 <i>w/ alu support. Left. Class 1.</i>			
		Dim.: 410x250 mm	Colour: Red/white Material: Canvas + film Shape: Rectangular

EL. SPECIFICATIONS		DIMENSIONS	ADDITIONAL SPECIFICATIONS
171880 Warning Liftflag w/ alu Std pkg 1 Servicing: HC-CARGO 171882 <i>w/ alu support. Right. Class 1.</i>			
		Dim.: 410x250 mm	Colour: Red/white Material: Canvas + film Shape: Rectangular
171881 Warning Liftflag w/ alu Std pkg 1 Servicing: HC-CARGO 171882 <i>w/ alu support. Left. Class 1.</i>			
		Dim.: 410x250 mm	Colour: Red/white Material: Canvas + film Shape: Rectangular
171882 Warning Liftflag w/ alu Kit Std pkg 1 <i>w/ alu support. Kit. Class 1. Warning Liftflag: HC-CARGO 171880, 171881.</i>			
		Dim.: 410x250 mm	Colour: Red/white Material: Canvas + film Shape: Rectangular
171891 Wide Load Marking Std pkg 1 <i>For Agriculture. Class 1. DIN 11030.</i>			
		Dim.: 423x423x0.8 mm	Colour: Red/white Material: Zinc + film Shape: Square
171892 Wide Load Marking Kit Std pkg 1 <i>For Agriculture. Kit. Class 1. DIN 11030.</i>			
		Dim.: 564x282x0.8 mm	Colour: Red/white Material: Zinc + film Shape: Rectangular
171893 Wide Load Marking Std pkg 1 <i>Class 1.</i>			
		Dim.: 900x300x2 mm	Colour: Black/yellow/red Material: Aluminium + film Shape: Rectangular
171894 Wide Load Marking Std pkg 1 <i>Class 1.</i>			
		Dim.: 565x200x2 mm	Colour: Black/yellow/red Material: Aluminium + film Shape: Rectangular

CONTAINER MARKING

171895 Skipmarking Std pkg 1

Self-adhesive. Left. Class 2.



Dim.: 100x400 mm

Colour: Red/white
Material: Film
Shape: Rectangular

171896 Skipmarking Std pkg 1

Self-adhesive. Right. Class 2.



Dim.: 100x400 mm

Colour: Red/white
Material: Film
Shape: Rectangular

171897 Skipmarking Std pkg 1

Self-adhesive kit. Class 2.



Dim.: 200x400 mm

Colour: Red/white
Material: Film
Shape: Rectangular

WARNING TRIANGLES

170171 Warning Triangle Std pkg 1

Break down warning triangle. Supplied in plastic carrying box.



Dim.: 440x440x440 mm

Shape: Triangle
E-approval: Yes

TRIANGLES

170390 Reflector Triangle Std pkg 5

Red: high intensive foil. Class A. Red: fluorescent foil. w/o bracket. Mounting Bracket: HC-CARGO 170391, 170392, 170797. Mounting Bracket Kit: HC-CARGO 170393.



Dim.: 350-365 mm
Dist. mount. holes:
153 mm

Colour: Red
Material: Aluminium
Shape: Triangle
E-approval: Yes

170407 Reflector Foil Std pkg 5

Red: high intensive reflex. Class A. Red: fluorescent.



Dim.: 409x358x308 mm

Colour: Red
Shape: Triangle
Mount.: Self adhesive
E-approval: Yes







170759 Reflector Triangle Std pkg 5

Red: high intensive foil. Class A. Red: fluorescent foil. w/o bracket. Mounting Bracket: HC-CARGO 170391, 170392, 170797. Mounting Bracket Kit: HC-CARGO 170393.

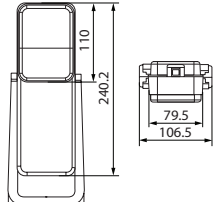

Dim.: 428x375x310 mm
Dist. mount. holes:
153 mm
Hole size: 6 mm

Colour: Red
Material: Shock thermo plastic
Shape: Triangle
E-approval: Yes

ACCESSORIES			
170391	Mounting Bracket	Std pkg 1	Servicing: HC-CARGO 170390, 170759, 170393
<i>Male.</i>			
			
170392	Mounting Bracket	Std pkg 1	Servicing: HC-CARGO 170390, 170759, 170393
<i>Female.</i>			
			
170393	Mounting Bracket Kit	Std pkg 1	Servicing: HC-CARGO 170390, 170759
<i>w/ male and female brackets, bolts and nuts. Contains: 2 pcs: HC-CARGO 170780. 2 pcs: HC-CARGO 190590. 2 pcs: HC-CARGO 190477. 1 pcs: HC-CARGO 170391. 1 pcs: HC-CARGO 170392.</i>			
			
170797	Mounting Bracket	Std pkg 1	Servicing: HC-CARGO 170390, 170759
<i>Angled.</i>			
			
HAZARD WARNING LIGHTS			
170683	Hazard Warning Lamp	Std pkg 1	Servicing: Approved for vehicles carrying dangerous goods - Visit our web catalogue for further information
<i>Battery: HC-CARGO 200741, 200768.</i>			
			Dim.: 240.2x106.5 mm
			Battery type: D No./batteries: 5 Hazard flasher: Yes Approval: GGVS/ADR E-approval: Yes
PEN/TORCH LIGHTS			
TORCH LIGHT LED/UV			
171805	UV LED Torch Light	Std pkg 1	
<i>Battery: HC-CARGO 200738.</i>			
		Dim.: 126 mm	Bulb type: UV LED Battery type: AAA Material: Aluminium No./batteries: 3 Waterproof: Yes Approval: CE

253489 UV Inspection Lamp Std pkg 1

3 pcs. Batteries and mirror included. Batteries: HC-CARGO 200858.



Bulb incl.: Yes

 Type: LED
 Colour: Blue
 Model: UV

PEN-/TORCH LIGHTS LED

171704 LED Penlight Std pkg 1

Button w/ easy touch for either signal or constant light. Optical lense intensive the light. At least 8 hours of burn time. Battery: HC-CARGO 200738.



Dim.: 14.5x109 mm

 Bulb type: LED
 Battery type: AAA
 Material: Aluminium
 No./batteries: 1
 Drop proof: Yes
 Waterproof: Yes
 Approval: CE

172103 LED Penlight - 1 pcs Std pkg 1

Battery: HC-CARGO 200738.



Lumen: 80

Dim.: 200x28x20 mm

 Bulb type: LED
 Battery type: AAA
 Material: Rubber
 No./batteries: 4
 Magnet holder: w/
 Carrying strap: Yes
 Approval: CE
 Alternativ no.: 172104

172104 LED Penlight - 12 pcs Std pkg 1

Battery: HC-CARGO 200738.



Lumen: 80

Dim.: 200x28x20 mm

 Bulb type: LED
 Battery type: AAA
 Material: Rubber
 No./batteries: 4
 Magnet holder: w/
 Carrying strap: Yes
 Approval: CE
 Alternativ no.: 172103

172194 LED Head Lamp Std pkg 1

Lumen: 420

Dim.: 33x45 mm

 Bulb type: LED
 Battery type: Lithium
 Material: Aluminium
 No./batteries: 1
 Carrying strap: No
 Retractable tripod: No
 Rechargeable: Yes
 Tightness norm: IP 65

HAND LAMPS CONVENTIONAL

200181 Hand Lamp Std pkg 1

Works at temperature below zero. All parts are replaceable. Neon tube: HC-CARGO 170664.

 Voltage: 230
 Watt: 8
 Lumen: 400

 Length: 510 mm
 Cable length: 5 mm
 Weight: 700 g

 Plug: w/
 Hi impact: Yes
 Tightness norm: IP 67
 Approval: CE

200635 Hand Lamp Std pkg 1

Four times as powerful as regular hand-lamps. Operating at temperatures below zero degrees. All parts can be replaced. Resistant to oil, gasoline and chemicals. Fluorescent: HC-CARGO 171573. Electronics Part: HC-CARGO 200659.

 Voltage: 230
 Watt: 11
 Lumen: 900

 Length: 455 mm
 Cable length: 5 mm
 Weight: 775 g

 Plug: w/
 Hi impact: Yes
 Tightness norm: IP 64
 Approval: CE



200728 Hand Lamp Std pkg 1			
Works at temperature below zero. All parts are replaceable. Electronic Part: HC-CARGO 200659.			
		Voltage: 230 Watt: 9 Lumen: 400	Length: 390 mm Cable length: 5 mm Weight: 720 g
			Plug: w/ Hi impact: Yes Tightness norm: IP 65 Approval: CE
200837 Hand Lamp Std pkg 1			
		Voltage: 230 Watt: 11 Lumen: 380	Length: 450 mm Cable length: 5 mm Weight: 585 g
			Hi impact: Yes Tightness norm: IP 54 Approval: CE

SPARE PARTS/ACCESSORIES

200659 Electronic Part Std pkg 1 Servicing: HC-CARGO 200728, 200635			
		Watt: 230	Tightness norm: IP 65 Approval: CE
200684 Lamp Holder Std pkg 1			
For hand lamps.			
			Tightness norm: IP 67

HAND LAMPS LED

172186 LED Hand Lamp Std pkg 1			
		Voltage: 230/240 Watt: 3.5 Lumen: 400	Dim.: 32x3.8x2.7 cm Length: 320 mm Cable length: 5 mm Weight: 615 g
			Plug: w/ Tightness norm: IP 20 Approval: CE Alternativ no.: 200733
172187 LED Hand Lamp Std pkg 1			
USB Adapter 230 V: HC-CARGO 181743.			
		Watt: 3 Lumen: 350	Dim.: 280x48x40 mm
			Bulb type: LED Battery type: Li-ion Magnet holder: w/ Lamp head: Yes Wall charger 230 V: No Rechargeable: Yes Approval: CE Alternativ no.: 171999, 172000

		EL. SPECIFICATIONS	DIMENSIONS	ADDITIONAL SPECIFICATIONS
172189	LED Hand Lamp	Std pkg 1		
		Watt: 3 Lumen: 300	Dim.: 55x45x215 mm	Bulb type: LED Battery type: Li-ion Magnet holder: w/ Lamp head: Yes Wall charger 230 V: Yes Charger 12 V: Yes Rechargeable: Yes Approval: CE
172190	LED Hand Lamp UK	Std pkg 1		
		Lumen: 300	Dim.: 55x45x215 mm	Bulb type: LED Battery type: Li-ion Magnet holder: w/ Lamp head: Yes Wall charger 230 V: Yes Charger 12 V: Yes Rechargeable: Yes Approval: CE
SPARE PARTS				
181743	USB Adapter	Std pkg 1	Servicing: HC-CARGO 172187	
		Voltage: 5 Amp: 0.5		Approval: CE
BULB HOLDERS				
170135	Bulb Holder	Std pkg 10		
				Socket type: BAY15d Connection: Screw M5
170136	Bulb Holder	Std pkg 10		
				Socket type: BA9s Connection: Screw M5
170137	Bulb Holder	Std pkg 10		
				Socket type: BA7s Connection: Screw M5
170138	Bulb Holder	Std pkg 10		
				Socket type: BA15S Connection: Screw M5

EL. SPECIFICATIONS		DIMENSIONS	ADDITIONAL SPECIFICATIONS
170139 Bulb Holder	Std pkg 10		
<i>33-36 mm. Festoon type.</i>			
			Socket type: S8.5 Connection: Screw M5
170433 Bulb Holder	Std pkg 1	Servicing: H4 - Visit our web catalogue for further information	
<i>Also for bulbs that fit socket P45t. Used w/ sealed beams.</i>			
			Socket type: P43t Connection: Terminal
170596 Bulb Holder	Std pkg 10		
			Socket type: BA15d Connection: Screw M5
170619 Bulb Holder	Std pkg 10	Servicing: H4, HC-CARGO 171281	
<i>Also for bulbs that fit socket P43t. Used w/ sealed beams. Terminal: HC-CARGO 191200.</i>			
			Socket type: P45t Connection: Plug
170763 Bulb Holder	Std pkg 10	Servicing: VW Golf, Vento, Polo, Passat, Seat Ibiza, Toledo - Visit our web catalogue for further information	
			Socket type: T10 Connection: Multiplug
170790 Bulb Holder	Std pkg 10		
<i>2x terminal connection.</i>			
			Socket type: BA9s Connection: Terminal
170791 Bulb Holder	Std pkg 10		
<i>2x screw connection.</i>			
			Socket type: BA15S Connection: Screw M5

170799 Bulb Holder Std pkg 10 Servicing: HC-CARGO 171282

Also for bulbs that fit socket P45t. Used w/ sealed beams. Angled type. Terminal: HC-CARGO 191938.

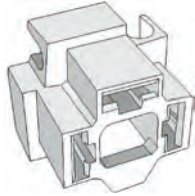

Socket type: P43t
Connection: Plug

170827 Bulb Holder Std pkg 10

2x terminal connection.



Socket type: T10
Connection: Terminal

170964 Bulb Holder Std pkg 10 Servicing: H4 - Visit our web catalogue for further information

Also for bulbs that fit socket P45. Used w/ sealed beams. w/ snap-lock action for cable connection.



Socket type: P43t+P45t
Connection: Cable

171281 Bulb Holder Set Std pkg 1 Servicing: H4 - Visit our web catalogue for further information

Contains: 1x HC-CARGO 170619. 3x HC-CARGO 191200.



Socket type: P43t
Connection: Plug

171282 Bulb Holder Set Std pkg 1 Servicing: H4 - Visit our web catalogue for further information

Contains: 1x HC-CARGO 170799. 3x HC-CARGO 191938.

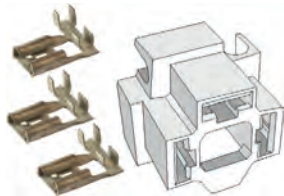

Socket type: P43t
Connection: Plug

171426 Bulb Holder Std pkg 1

w/ wire.





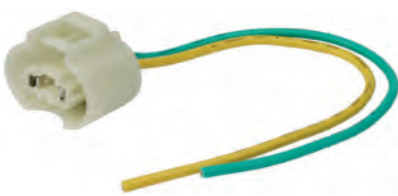

Socket type: HB3, H10, H12
Connection: Cable

171427 Bulb Holder Std pkg 1

w/ wire.

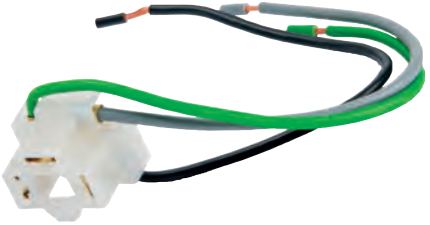
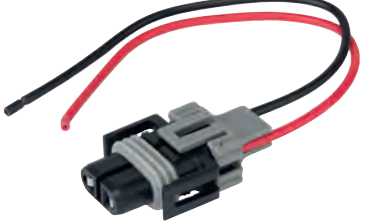

Socket type: HB4
Connection: Cable

		EL. SPECIFICATIONS	DIMENSIONS	ADDITIONAL SPECIFICATIONS
171453	Bulb Holder	Std pkg 10	Servicing: H7 - Visit our web catalogue for further information	
				Socket type: PX26d Connection: Cable
171783	Bulb Holder	Std pkg 1	Servicing: HB1, HB5 - Visit our web catalogue for further information	
				Socket type: HB1, HB5 Connection: Cable
171784	Bulb Holder	Std pkg 1	Servicing: H8, H9, H11 - Visit our web catalogue for further information	
				Socket type: H8, H9, H11 Connection: Cable
171924	Bulb Holder	Std pkg 1	Servicing: H1/H3 - Visit our web catalogue for further information	
<p>2 way.</p> 				Socket type: P14.5s, PK22s, PKY22s Connection: Cable
171925	Bulb Holder	Std pkg 1	Servicing: H1/H3 - Visit our web catalogue for further information	
<p>1 way.</p> 				Socket type: P14.5s, PK22s, PKY22s Connection: Cable
171954	Bulb Holder	Std pkg 1	Servicing: H4 - Visit our web catalogue for further information	
				Socket type: P43t Connection: Cable
172072	Bulb Holder	Std pkg 1	Servicing: HC-CARGO 171010, 170951, 171953, 170726	
				Socket type: PGJ13 Connection: Cable



Multi Function Lamps

Edition 2018/2019



HC-CARGO	Dimension	Servicing	Right / Left	Flasher light	Number Plates light	Rear fog lamp	Reflector	Reverse light	Side marker lamp	Stop light	Tail light	Connection	E- Approval	Replacing	Lens
171308	525 x 139 x 83	Mercedes Actros	RH	✓	✓	✓	✓	✓	✓	✓	✓	M	✓	42940000, 42939000, 0015406370	HC-CARGO 171312
171311	525 x 139 x 83	Mercedes Actros	LH	✓	✓	✓	✓	✓	✓	✓	✓	M	✓	42942000, 42941000, 0015406270	HC-CARGO 171521
171447	525 x 139 x 83	Mercedes Actros, SK	LH	✓	✓	✓	✓	✓	✓	✓	✓	G	✓	2VD007500-091	HC-CARGO 171521
171448	525 x 139 x 83	Mercedes Actros, SK	RH	✓	✓	✓	✓	✓	✓	✓	✓	B	✓		HC-CARGO 171312
171802	517 x 129.5 x 80.2	Scania	RH	✓	✓	✓	✓	✓	✓	✓	✓		✓		HC-CARGO 171322
171803	517 x 129.5 x 80.2	Scania	LH	✓	✓	✓	✓	✓	✓	✓	✓		✓		HC-CARGO 171322
170916	465 x 130 x 83	Scania, Universal.	LH	✓	✓	✓	✓	✓	✓	✓	✓	A		2VD007323-031, 21.197-021, 21.197-001, 170914, 168350, 168340, 1365963	HC-CARGO 170968
170917	465 x 130 x 83	Scania, Universal	RH	✓	✓	✓	✓	✓	✓	✓	✓	A	✓	2VP007323-021, 2VD007323-041, 21.197-031, 21.197-011, 170915, 168360, 168270, 167600, 1365965, 1365964	HC-CARGO 170968
170922	465 x 130 x 83	MAN, Universal	LH	✓	✓	✓	✓		✓	✓	✓	C	✓	2VD007323-131, 21.197-121, 168100	HC-CARGO 170968
170923	465 x 130 x 83	MAN, Universal	RH	✓	✓	✓	✓		✓	✓	✓	C	✓	2VP007323-121, 2VD007323-141, 21.197-131, 21.197-111, 170921, 167700	HC-CARGO 170968
170998	465 x 130 x 83	Iveco	RH/LH	✓		✓	✓		✓	✓	✓	D	✓	99463242, 44847000, 171298	HC-CARGO 171000
170999	465 x 130 x 83	Iveco	RH/LH	✓	✓	✓	✓		✓	✓	✓	D	✓	99463244, 44848000	HC-CARGO 171000
171299	465 x 130 x 90	Mercedes Atego	RH	✓	✓	✓	✓		✓	✓	✓	P	✓	42931000, 42632000, 0035445503, 0035445203	HC-CARGO 171307
171302	465 x 130 x 90	Mercedes Atego	LH	✓	✓	✓	✓		✓	✓	✓	P	✓	42934000, 0035445603, 0035445303	HC-CARGO 171307
171303	465 x 130 x 90	Mercedes Sprinter	RH	✓	✓	✓	✓		✓	✓	✓	K	✓	42935000, 42936000, 0035445403	HC-CARGO 171307
171306	465 x 130 x 90	Mercedes Sprinter	LH	✓	✓	✓	✓		✓	✓	✓	K	✓	42938000, 42937000, 0025445503	HC-CARGO 171307
171806	428 x 140 x 87	Trucks, Universal	LH	✓		✓		✓	✓	✓	✓	M	✓		HC-CARGO 171810
171807	428 x 140 x 87	Trucks, Universal	RH	✓		✓		✓	✓	✓	✓	M	✓		HC-CARGO 171810
171808	428 x 140 x 87	Commercial trailers	LH	✓		✓	✓	✓	✓	✓	✓	M	✓		HC-CARGO 171810
171809	428 x 140 x 87	Commercial trailers	RH	✓		✓	✓	✓	✓	✓	✓	M	✓		HC-CARGO 171810
171441	421 x 147 x 75	Commercial Trailers	LH	✓	✓		✓			✓	✓	K	✓		HC-CARGO 171446
171442	421 x 147 x 75	Commercial Trailers	RH	✓	✓		✓			✓	✓	K	✓		HC-CARGO 171446
171443	421 x 147 x 75	Schwarz Müller	LH	✓	✓		✓			✓	✓	I			HC-CARGO 171446
171444	421 x 147 x 75	Schwarz Müller	RH	✓	✓		✓			✓	✓	I			HC-CARGO 171446
170990	418 x 148 x 90	Commercial Trailers	RH	✓	✓	✓	✓		✓	✓	✓	A	✓		HC-CARGO 170994
170991	418 x 148 x 90	Commercial Trailers	LH	✓	✓	✓	✓		✓	✓	✓	A	✓		HC-CARGO 170995
170602	406 x 135 x 74	RVI Renault, Pegaso	LH	✓	✓	✓	✓	✓		✓	✓	A	✓	141500	HC-CARGO 170665
170603	406 x 135 x 74	RVI Renault, Pegaso	RH	✓		✓	✓	✓		✓	✓	A	✓		HC-CARGO 170665
171506	350 x 130 x 85	DAF, Nissan, Renault	RH/LH	✓	✓	✓	✓	✓		✓	✓	J			HC-CARGO 171507
171508	350 x 130 x 85	Commercial Trailers	RH/LH	✓	✓	✓		✓		✓	✓	K			HC-CARGO 171509
171206	343 x 133 x 75	MAN, VW, Mercedes	LH	✓	✓	✓	✓	✓		✓	✓	A		2SL003567-691, 21.147-081	HC-CARGO 171263
170893	335 x 96 x 83		RH	✓						✓	✓	A		2SD001688-141, 21.002-031, 21.002-031, 21.002-021, 21.002-021, 170892	HC-CARGO 171062
170895	335 x 96 x 83		LH	✓						✓	✓	A		2SD001688-171, 21.002-071, 21.002-071	HC-CARGO 171062

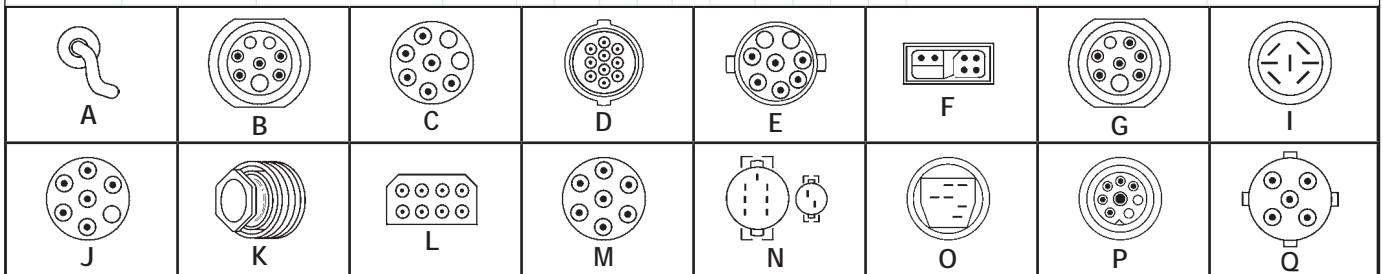



Bulbs

Edition 2018/2019

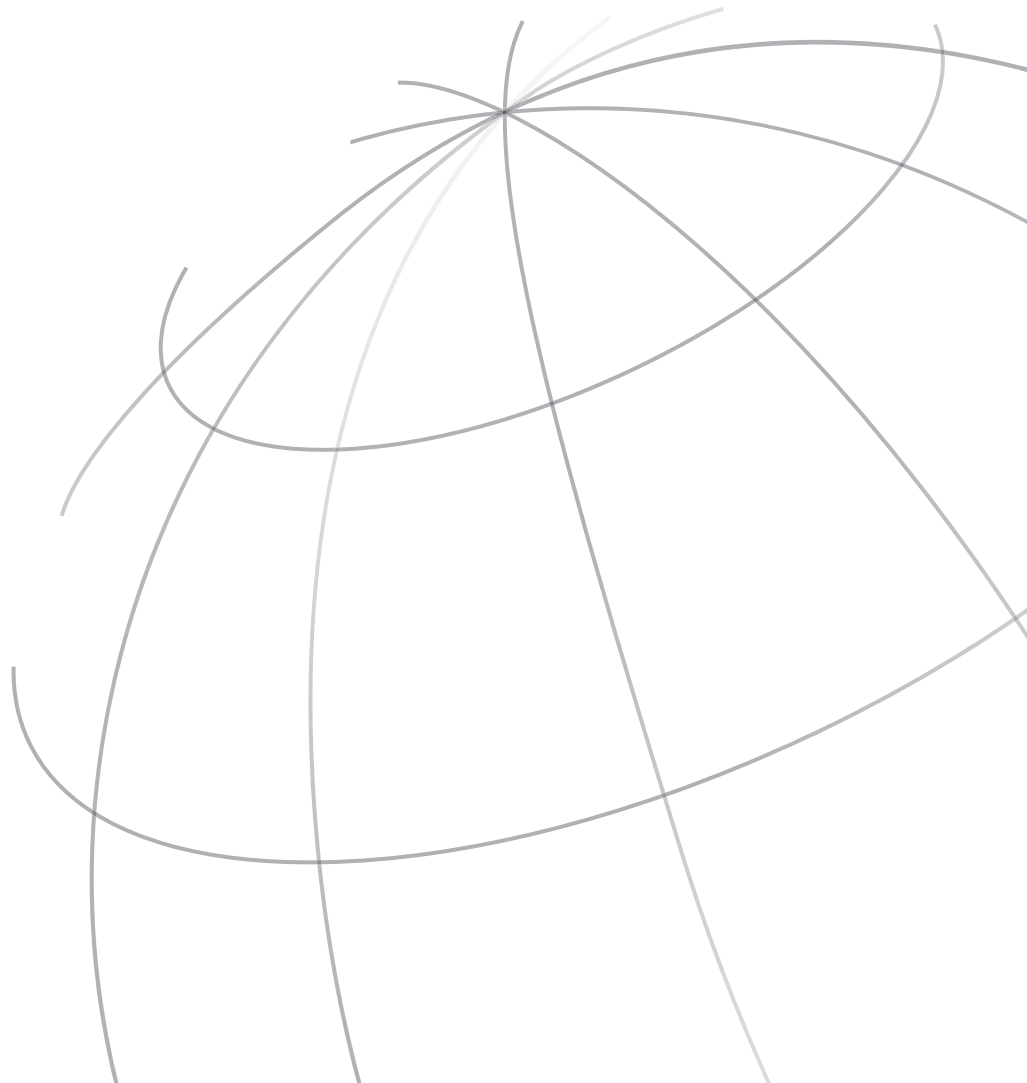

H1 HALOGEN

	HC-CARGO	Std. pkg.	Voltage	Watt	Length	OD	Colour	Type	Comment
 P14.5s	170069	Pkg. 1	12	55	62.5 mm	8.5 mm		Single filament	
	171070	Pkg. 1	12	55	62.5 mm	8.5 mm		Single filament	<i>Gives up to 30% more light.</i>
	171071	Pkg. 1	12	55	62.5 mm	8.5 mm	Xenon blue	Single filament	
	171136	Pkg. 1	12	55	62.5 mm	8.5 mm		Single filament	<i>Gives up to 50% more light.</i>
	171068	Pkg. 1	12	100	62.5 mm	8.5 mm		Single filament	<i>Not E-approved.</i>
	171404	Pkg. 1	12	130	59.8 mm	9.7 mm		Single filament	<i>Not E-approved.</i>
	171072	Pkg. 1	24	70	62.5 mm	8.5 mm		Single filament Heavy duty	
John	HC-CARGO	Std. pkg.	Voltage	Watt	Length	OD	Colour	Type	Comment
 P14.5s	170332	Pkg. 1	12	55	62.5 mm	8.5 mm		Single filament	
	170965	Pkg. 1	12	55	62.5 mm	8.5 mm		Single filament Megalight	<i>Gives up to 30% more light.</i>
	170493	Pkg. 1	12	100	62.5 mm	8.5 mm		Single filament	<i>Not E-approved.</i>
	170494	Pkg. 1	24	100	62.5 mm	8.5 mm		Single filament Heavy duty	<i>Not E-approved.</i>
	170449	Pkg. 1	24	70	62.5 mm	8.5 mm		Single filament Heavy duty	
OSRAM	HC-CARGO	Std. pkg.	Voltage	Watt	Length	OD	Colour	Type	Comment
 P14.5s	171686	Pkg. 1	12	55	58.9 mm	9 mm		Nightbreaker	<i>Up to 90% more light. Up to 35 m longer beam. Up to 10% whiter light.</i>

H2 HALOGEN

	HC-CARGO	Std. pkg.	Voltage	Watt	Length	OD	Colour	Type	Comment
 X511	171073	Pkg. 1	12	55	30 mm	9 mm		Single filament	
	170512	Pkg. 1	24	100	30 mm	9 mm		Single filament Heavy duty	<i>Not E-approved.</i>

H3 HALOGEN

	HC-CARGO	Std. pkg.	Voltage	Watt	Length	OD	Colour	Type	Comment
 PK22s	171469	Pkg. 1	6	55	42 mm	11.5 mm		Single filament	<i>Not E-approved.</i>
	170070	Pkg. 1	12	55	42 mm	11.5 mm		Single filament	
	171405	Pkg. 1	12	130	39 mm	11.5 mm		Single filament	<i>Not E-approved.</i>
	170836	Pkg. 1	24	70	42 mm	11.5 mm		Single filament Heavy duty	
	171407	Pkg. 1	48	45	42 mm	11.5 mm			<i>Not E-approved.</i>
	171378	Pkg. 1	80	55	42 mm	11.5 mm			<i>Not E-approved.</i>
John	HC-CARGO	Std. pkg.	Voltage	Watt	Length	OD	Colour	Type	Comment
 PK22s	170696	Pkg. 1	12	35	42 mm	11.5 mm		Single filament	<i>Not E-approved.</i>
	170333	Pkg. 1	12	55	42 mm	11.5 mm		Single filament	
	170412	Pkg. 1	24	70	42 mm	11.5 mm		Single filament Heavy duty	
	170362	Pkg. 1	24	100	42 mm	11.5 mm		Single filament Heavy duty	<i>Not E-approved.</i>
 PKY22s	170496	Pkg. 1	12	100	42 mm	11.5 mm		Single filament	<i>Not E-approved.</i>
OSRAM	HC-CARGO	Std. pkg.	Voltage	Watt	Length	OD	Colour	Type	Comment
 PK22s	171687	Pkg. 1	12	55	42 mm	10.8 mm		Nightbreaker	<i>Up to 90% more light. Up to 35 m longer beam. Up to 10% whiter light.</i>

H4 HALOGEN

	HC-CARGO	Std. pkg.	Voltage	Watt	Length	OD	Colour	Type	Comment
 P43t	171474	Pkg. 1	6	60/55	78 mm	16 mm			Not E-approved.
	170768	Pkg. 1	12	60/55	78 mm	16 mm		Double filament	
	171066	Pkg. 1	12	60/55	78 mm	16 mm		Double filament	Gives up to 30% more light.
	171067	Pkg. 1	12	60/55	78 mm	16 mm	Xenon blue	Double filament	Brighter light as standard.
	171113	Pkg. 1	12	60/55	78 mm	16 mm		Double filament Longlife	
	171114	Pkg. 1	12	60/55	78 mm	16 mm	Gold	Double filament	Gives better visibility in poor weather conditions.
	171134	Pkg. 1	12	60/55	78 mm	16 mm		Double filament	Gives up to 50% more light.
	170803	Pkg. 1	12	100/80	78 mm	16 mm	Xenon blue	Double filament	Brighter light as standard. Not E-approved.
	171065	Pkg. 1	12	100/80	78 mm	16 mm		Double filament	Not E-approved.
	170513	Pkg. 1	12	130/90	76.4 mm	14.6 mm		Double filament	Not E-approved.
	170515	Pkg. 1	24	130/90	78 mm	16 mm		Double filament Heavy duty	Not E-approved.
	170792	Pkg. 1	24	75/70	78 mm	16 mm		Double filament Heavy duty	
171125	Pkg. 1	24	75/70	78 mm	16 mm		Double filament Heavy duty		
 P45t	170071	Pkg. 1	12	60/55	78 mm	16 mm		Double filament	Not E-approved.
 PX43t	171473	Pkg. 1	6	35/35	78 mm	16 mm		HS1	Not E-approved.
Jahn									
 P43t	170009	Pkg. 1	12	100/90	78 mm	16 mm		Double filament	Not E-approved.
	170718	Pkg. 1	12	35/35	78 mm	16 mm		Double filament	
	170334	Pkg. 1	12	60/55	78 mm	16 mm		Double filament	
	170657	Pkg. 1	12	60/55	78 mm	16 mm		Double filament Longlife	
	170802	Pkg. 1	12	60/55	78 mm	16 mm	Xenon blue	Double filament	Brighter light as standard.
	170804	Pkg. 1	12	60/55	78 mm	16 mm		Double filament Megalight	Gives up to 30% more light.
	171064	Pkg. 1	12	60/55	78 mm	16 mm		Double filament Megalight plus	Gives up to 60% more light.
	170360	Pkg. 1	24	100/70	78 mm	16 mm		Heavy duty	Not E-approved.
	170348	Pkg. 1	24	75/70	78 mm	16 mm		Heavy duty	
	170450	Pkg. 1	24	75/70	78 mm	16 mm		Heavy duty	
 P45t	170359	Pkg. 1	12	100/80	78 mm	16 mm			Not E-approved.
	170681	Pkg. 1	12	45/40	78 mm	16 mm			
	170006	Pkg. 1	24	75/70	78 mm	16 mm		Heavy duty	Not E-approved.
OSRAM									
 P43t	171688	Pkg. 1	12	60/55	82 mm	13 mm		Double filament Nightbreaker	Up to 90% more light. Up to 35 m longer beam. Up to 10% whiter light.
MH6 HALOGEN									
 PX15d	170811	Pkg. 10	12	30/30	47 mm	20 mm		Bilux	Not E-approved.
	170812	Pkg. 10	12	30/30	55 mm	15 mm		Double filament	Not E-approved.

H7 HALOGEN

	HC-CARGO	Std. pkg.	Voltage	Watt	Length	OD	Colour	Type	Comment
	172111	Pkg. 1	24	100	58 mm	34 mm		Heavy duty	Not E-approved.
	171077	Pkg. 1	12	55	58 mm	11.6 mm		Single filament	
	171079	Pkg. 1	12	55	58 mm	11.6 mm	Xenon blue	Single filament	Brighter light as standard.
	171081	Pkg. 1	12	55	58 mm	11.6 mm		Single filament	Gives up to 30% more light.
	171117	Pkg. 1	12	55	58 mm	11.6 mm		Single filament Longlife	
	171137	Pkg. 1	12	55	58 mm	11.6 mm		Single filament	Gives up to 50% more light.
	170837	Pkg. 1	12	100	58 mm	11.6 mm		Single filament	Not E-approved.
	171080	Pkg. 1	24	70	58 mm	11.6 mm		Single filament Heavy duty	
	171532	Pkg. 1	24	70	58 mm	11.6 mm		Longlife Heavy duty	
	HC-CARGO	Std. pkg.	Voltage	Watt	Length	OD	Colour	Type	Comment
	170720	Pkg. 1	12	55	58 mm	11.6 mm		Single filament	
	170825	Pkg. 1	12	55	58 mm	11.6 mm	Xenon blue	Single filament	Brighter light as standard.
	170800	Pkg. 1	24	70	58 mm	11.6 mm		Single filament Heavy duty	
	HC-CARGO	Std. pkg.	Voltage	Watt	Length	OD	Colour	Type	Comment
	171689	Pkg. 1	12	55	59 mm	11.4 mm		Conventional Nightbreaker	Up to 90% more light. Up to 35 m longer beam. Up to 10% whiter light.

H13 HALOGEN

	HC-CARGO	Std. pkg.	Voltage	Watt	Length	OD	Colour	Type	Comment
	171796	Pkg. 1	12	60/55	86 mm	16.1 mm			

H15 HALOGEN

	HC-CARGO	Std. pkg.	Voltage	Watt	Length	OD	Colour	Type	Comment
	171691	Pkg. 1	12	15/55	79 mm	13 mm		Double filament	

H6W HALOGEN

	HC-CARGO	Std. pkg.	Voltage	Watt	Length	OD	Colour	Type	Comment
	171082	Pkg. 10	12	6	35 mm	9 mm			
	HC-CARGO	Std. pkg.	Voltage	Watt	Length	OD	Colour	Type	Comment
	170741	Pkg. 10	12	6	33 mm	9 mm			

H21W HALOGEN

	HC-CARGO	Std. pkg.	Voltage	Watt	Length	OD	Colour	Type	Comment
<p>BAY9s</p>	171083	Pkg. 10	12	21	40 mm	10 mm			
	171084	Pkg. 10	24	21	40 mm	10 mm		Heavy duty	
<p>P26s</p>	171135	Pkg. 10	12	15	36 mm	10 mm		Single filament	<i>Not E-approved.</i>
	HC-CARGO	Std. pkg.	Voltage	Watt	Length	OD	Colour	Type	Comment
<p>BAY9s</p>	170742	Pkg. 10	12	21	40 mm	10 mm			

HB1 AMERICAN TYPES

	HC-CARGO	Std. pkg.	Voltage	Watt	Length	OD	Colour	Type	Comment
<p>P29t</p>	170692	Pkg. 1	12	65/45	95 mm	16.5 mm		Halogen	

HB3 AMERICAN TYPES

	HC-CARGO	Std. pkg.	Voltage	Watt	Length	OD	Colour	Type	Comment
<p>P20d</p>	170693	Pkg. 1	12	65	78 mm	16 mm		Halogen	

HB3 A AMERICAN TYPES

	HC-CARGO	Std. pkg.	Voltage	Watt	Length	OD	Colour	Type	Comment
<p>P20d</p>	171804	Pkg. 1	12	60	70.9 mm	11.9 mm		Halogen	

HB4 AMERICAN TYPES

	HC-CARGO	Std. pkg.	Voltage	Watt	Length	OD	Colour	Type	Comment
<p>P22d</p>	170694	Pkg. 1	12	51	78 mm	16 mm		Halogen	

HB4 A AMERICAN TYPES

	HC-CARGO	Std. pkg.	Voltage	Watt	Length	OD	Colour	Type	Comment
<p>P22d</p>	171794	Pkg. 1	12	51	80.3 mm	10.7 mm		Halogen	

HB5 AMERICAN TYPES

	HC-CARGO	Std. pkg.	Voltage	Watt	Length	OD	Colour	Type	Comment
<p>PX29t</p>	171039	Pkg. 1	12	65/55	102 mm	17 mm		Halogen	

H8 AMERICAN TYPES

John	HC-CARGO	Std. pkg.	Voltage	Watt	Length	OD	Colour	Type	Comment
 PGJ19-1	171034	Pkg. 1	12	35	41 mm	11.7 mm		Halogen	

H9 AMERICAN TYPES

John	HC-CARGO	Std. pkg.	Voltage	Watt	Length	OD	Colour	Type	Comment
 PGJ19-5	171035	Pkg. 1	12	65	41 mm	11.7 mm		Halogen	

H10 AMERICAN TYPES

John	HC-CARGO	Std. pkg.	Voltage	Watt	Length	OD	Colour	Type	Comment
 PY20d	171036	Pkg. 1	12	42	31.5 mm	12.4 mm		Halogen	

H11 AMERICAN TYPES

HC-CARGO	HC-CARGO	Std. pkg.	Voltage	Watt	Length	OD	Colour	Type	Comment
 PGJ19-2	172073	Pkg. 1	24	70	44 mm	31.5 mm		Halogen Heavy duty	

John	HC-CARGO	Std. pkg.	Voltage	Watt	Length	OD	Colour	Type	Comment
 PGJ19-2	171037	Pkg. 1	12	55	41 mm	11.7 mm		Halogen	

OSRAM	HC-CARGO	Std. pkg.	Voltage	Watt	Length	OD	Colour	Type	Comment
 PGJ19-2	171690	Pkg. 1	12	55	44 mm	11.4 mm		Halogen Nightbreaker	Up to 90% more light. Up to 35 m longer beam. Up to 10% whiter light.

H27W/1 AMERICAN TYPES

John	HC-CARGO	Std. pkg.	Voltage	Watt	Length	OD	Colour	Type	Comment
 PG13	171009	Pkg. 1	12	27	44.5 mm	10.3 mm		Halogen	



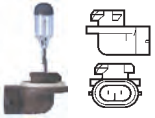

 W2.5x16q	170710	Pkg. 10	12	27/7	53 mm	26.5 mm		3157	
	170711	Pkg. 10	12	27/7	53 mm	26.5 mm	Orange	3157NA	Not E-approved.

H27W/2 AMERICAN TYPES

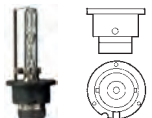
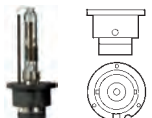
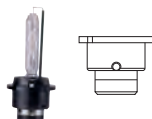
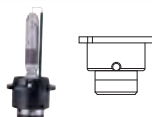

HC-CARGO	HC-CARGO	Std. pkg.	Voltage	Watt	Length	OD	Colour	Type	Comment
 PGJ13	171953	Pkg. 1	12	50	62.7 mm	12.5 mm		Halogen	Bulb Holder: HC-CARGO 172072. Not E-approved.

Jahn	HC-CARGO	Std. pkg.	Voltage	Watt	Length	OD	Colour	Type	Comment
 PGJ13	171010	Pkg. 1	12	27	44.5 mm	10.3 mm		Halogen	Bulb Holder: HC-CARGO 172072.
	170726	Pkg. 1	12	37.5	62.7 mm	12.5 mm		Halogen	Bulb Holder: HC-CARGO 172072. Not E-approved.
	170951	Pkg. 1	12	50	62.7 mm	12.5 mm		Halogen	Bulb Holder: HC-CARGO 172072. Not E-approved.

HIGH INTENSITY DISCHARGE

OSRAM	HC-CARGO	Std. pkg.	Voltage	Watt	Length	OD	Colour	Type	Comment
 P32d-2	171133	Pkg. 1	85	35	77 mm	13.7 mm	4150K	Xenon D2S	
 P32d-3	171132	Pkg. 1	85	35	79.7 mm	13.7 mm	4150K	Xenon D2R	
 P32d-5	171713	Pkg. 1	42	35	77 mm	13.7 mm	4150K	Xenon D4S	
 P32d-6	171711	Pkg. 1	42	35	79.7 mm	12.4 mm	4150K	Xenon D4R	
 PK-32d-6	171710	Pkg. 1	42	35	80 mm	9 mm	4150K	Xenon D3R	
 PK32d-2	171613	Pkg. 1	85	35	82 mm	41x41 mm	4150K	Xenon D1S	
 PK32d-3	171683	Pkg. 1	85	35	80 mm	13 mm	4150K	Xenon D1R	
 PK32d-5	171712	Pkg. 1	42	35	80 mm	13 mm	4150K	Xenon D3S	

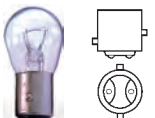
STOP AND TAIL LAMPS

THE CAR GO	HC-CARGO	Std. pkg.	Voltage	Watt	Length	OD	Colour	Type	Comment
 BAY15d	170770	Pkg. 10	12	21/5	52.5 mm	26.5 mm		P21/5W	
	171092	Pkg. 10	24	21/5	50 mm	25 mm		Heavy duty	
 BAZ15d	171093	Pkg. 10	12	21/4	50 mm	25 mm			





John	HC-CARGO	Std. pkg.	Voltage	Watt	Length	OD	Colour	Type	Comment
 BAY15d	171476	Pkg. 10	6	21/5	52.5 mm	26.5 mm			
	170336	Pkg. 10	12	21/5	52.5 mm	26.5 mm		P21/5W	
	170659	Pkg. 10	12	21/5	52.5 mm	26.5 mm		P21/5W Longlife	
	170452	Pkg. 10	24	21/5	52.5 mm	26.5 mm		Heavy duty	
 BAZ15d	170644	Pkg. 10	12	21/4	52.5 mm	26.5 mm			
	170850	Pkg. 10	24	21/4	52.5 mm	26.5 mm		Heavy duty	
 T20	170776	Pkg. 10	12	21/5	44 mm	20 mm			

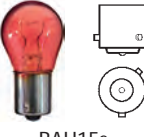
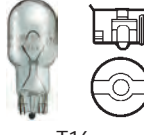
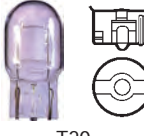

STOP AND FLASHER - POSITION

John	HC-CARGO	Std. pkg.	Voltage	Watt	Length	OD	Colour	Type	Comment
 BA15d	171998	Pkg. 10	6	15	45 mm	26.5 mm			<i>Not E-approved.</i>
	171989	Pkg. 10	12	20	45 mm	26.5 mm			<i>Not E-approved.</i>
	171994	Pkg. 10	12	20/5	52.2 mm	22.5 mm			<i>Not E-approved.</i>
	172033	Pkg. 10	12	20/5	52.5 mm	22.5 mm			<i>Not E-approved.</i>
	171088	Pkg. 10	24	15	43 mm	23 mm		Heavy duty	<i>Not E-approved.</i>
	171982	Pkg. 10	24	20	45 mm	26.5 mm		Heavy duty	<i>Not E-approved.</i>
 BA15S	171984	Pkg. 10	6	21	52.5 mm	26.5 mm			
	170772	Pkg. 10	12	10	35 mm	18 mm			
	171992	Pkg. 10	12	10	35 mm	19 mm		Longlife	
	171990	Pkg. 10	12	15	35 mm	19 mm			<i>Not E-approved.</i>
	171988	Pkg. 10	12	18	45 mm	26.5 mm			<i>Not E-approved.</i>
	171091	Pkg. 10	12	21	50 mm	25 mm	Orange		<i>Not E-approved.</i>
	170769	Pkg. 10	12	21	52.5 mm	26.5 mm		P21W	
	171979	Pkg. 10	12	21	52.5 mm	26.5 mm		P21W, Longlife	
	170793	Pkg. 10	24	10	35 mm	18 mm		Heavy duty	
	171076	Pkg. 10	24	10	35 mm	18 mm		Heavy duty	
	171997	Pkg. 10	24	15	35 mm	19 mm		Heavy duty	<i>Not E-approved.</i>
	171086	Pkg. 1	24	15	43 mm	23 mm		Heavy duty	<i>Not E-approved.</i>
	171996	Pkg. 10	24	18	45 mm	26.5 mm		Heavy duty	<i>Not E-approved.</i>
	170826	Pkg. 10	24	21	52.5 mm	26.5 mm		Heavy duty	
171078	Pkg. 10	24	21	52.5 mm	26.5 mm		Heavy duty		
171986	Pkg. 10	24	25	45 mm	26.5 mm		Heavy duty	<i>Not E-approved.</i>	
 BAU15s	171089	Pkg. 10	12	21	50 mm	25 mm	Orange		
	171371	Pkg. 1	12	21	50 mm	25 mm	Silver/amber		
	171090	Pkg. 10	24	21	50 mm	25 mm	Orange	Heavy duty	
 T13	171390	Pkg. 10	12	10	30 mm	13 mm			<i>Not E-approved.</i>
 T15	171402	Pkg. 10	12	10	36 mm	15 mm			<i>Not E-approved.</i>
	172230	Pkg. 10	12	16	38.1 mm	15.7 mm	Orange		<i>W2, 1x9, 5d</i>
	171403	Pkg. 10	12	21	36 mm	15 mm			<i>Not E-approved.</i>
John	HC-CARGO	Std. pkg.	Voltage	Watt	Length	OD	Colour	Type	Comment
 BA15d	170583	Pkg. 10	12	15	45 mm	26.5 mm			<i>Not E-approved.</i>

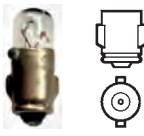
Jahn	HC-CARGO	Std. pkg.	Voltage	Watt	Length	OD	Colour	Type	Comment
 BA15S	170335	Pkg. 10	12	21	52.5 mm	26.5 mm		P21W	
	170454	Pkg. 10	24	10	35 mm	15 mm		Heavy duty	
	170351	Pkg. 10	24	10	35 mm	19 mm		R10W Heavy duty	
	170349	Pkg. 10	24	21	52.5 mm	26.5 mm		P21W Heavy duty	
	170451	Pkg. 10	24	21	52.5 mm	26.5 mm		Heavy duty	
 BAU15s	170648	Pkg. 10	12	21	52.5 mm	26.5 mm	Orange	PY21W	
	170849	Pkg. 10	24	21	52.5 mm	26.5 mm	Orange	Heavy duty	
 T16	170813	Pkg. 10	12	16	37 mm	15 mm			
 T20	170777	Pkg. 10	12	21	44 mm	20 mm			
	171398	Pkg. 10	12	21	44 mm	20 mm	Orange		

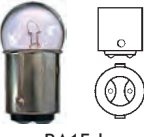
PARKING AND FLASHER - POSITION

Jahn	HC-CARGO	Std. pkg.	Voltage	Watt	Length	OD	Colour	Type	Comment
 BA15d	171102	Pkg. 10	24	5	35 mm	18.5 mm		Heavy duty	
 BA15S	171993	Pkg. 10	6	10	35 mm	18.5 mm			
	171983	Pkg. 10	6	18	45 mm	26.5 mm			<i>Not E-approved.</i>
	171981	Pkg. 10	6	5	35 mm	18.5 mm			
	170773	Pkg. 10	12	5	35 mm	18.5 mm			
	171980	Pkg. 10	12	5	35 mm	18.5 mm		Longlife	
	170794	Pkg. 10	24	5	35 mm	18.5 mm		Heavy duty	
 BA7s	171118	Pkg. 10	24	5	35 mm	18.5 mm		Heavy duty	
	171119	Pkg. 10	12	2	19 mm	6.8 mm			<i>Not E-approved.</i>
 BA9s	171490	Pkg. 10	6	3	27.4 mm	8.6 mm			<i>Not E-approved.</i>
	171103	Pkg. 10	12	2	23 mm	8.6 mm			<i>Not E-approved.</i>
	170774	Pkg. 10	12	4	27.4 mm	8.6 mm			
	170822	Pkg. 10	12	4	27.4 mm	8.6 mm	Xenon blue		<i>Brighter light as standard. Not E-approved.</i>
	170796	Pkg. 10	24	2	23 mm	8.6 mm		Heavy duty	<i>Not E-approved.</i>
 T15	170795	Pkg. 10	24	4	27.4 mm	8.6 mm		Heavy duty	
	171401	Pkg. 10	12	5	36 mm	15 mm			<i>Not E-approved.</i>
Jahn	HC-CARGO	Std. pkg.	Voltage	Watt	Length	OD	Colour	Type	Comment
 BA15d	170593	Pkg. 10	12	5	35 mm	18.5 mm			

John	HC-CARGO	Std. pkg.	Voltage	Watt	Length	OD	Colour	Type	Comment
 BA15S	170339	Pkg. 10	12	10	35 mm	19 mm			
	170340	Pkg. 10	12	5	35 mm	18.5 mm		R5W	
	170413	Pkg. 10	24	5	35 mm	18.5 mm		R5W Heavy duty	
	170455	Pkg. 10	24	5	35 mm	18.5 mm		Heavy duty	
 BA7s	170448	Pkg. 10	12	2	20.7 mm	6.8 mm			<i>Not E-approved.</i>
	170456	Pkg. 10	24	3	20.7 mm	6.8 mm		Heavy duty	<i>Not E-approved.</i>
 BA9s	171491	Pkg. 10	6	2	27.4 mm	8.6 mm			<i>Not E-approved.</i>
	171492	Pkg. 10	6	4	27.4 mm	8.6 mm			
	170345	Pkg. 10	12	2	23 mm	8.6 mm			<i>Not E-approved.</i>
	170594	Pkg. 10	12	3	23 mm	8.6 mm			<i>Not E-approved.</i>
	170346	Pkg. 10	12	4	27.4 mm	8.6 mm		T4W	
	170416	Pkg. 10	24	2	23 mm	8.6 mm		T2W Heavy duty	<i>Not E-approved.</i>
	170417	Pkg. 10	24	4	27.4 mm	8.6 mm		T4W Heavy duty	

WEDGE BASE

John	HC-CARGO	Std. pkg.	Voltage	Watt	Length	OD	Colour	Type	Comment
 T10	171121	Pkg. 10	12	2	26 mm	10 mm			<i>Not E-approved.</i>
	171104	Pkg. 10	12	3	26 mm	10 mm			
	170948	Pkg. 10	12	5	26 mm	10.3 mm	Xenon blue		<i>Brighter light as standard.</i>
	171105	Pkg. 10	12	5	26 mm	10 mm			
	171122	Pkg. 10	12	5	26 mm	10 mm	Blue		
	171123	Pkg. 10	12	5	26 mm	10 mm	Orange		
	170810	Pkg. 10	12	8	26 mm	10 mm			
	171106	Pkg. 10	24	3	26 mm	10 mm		Heavy duty	
 T5	170775	Pkg. 10	12	1.2	20 mm	5 mm			<i>Not E-approved.</i>
	171108	Pkg. 10	24	1.2	20 mm	5 mm		Heavy duty	<i>Not E-approved.</i>
 T7	171391	Pkg. 10	12	3	20 mm	7 mm			<i>Not E-approved.</i>

John	HC-CARGO	Std. pkg.	Voltage	Watt	Length	OD	Colour	Type	Comment
 T10	170725	Pkg. 10	12	2	26.7 mm	10.3 mm			<i>Not E-approved.</i>
	170779	Pkg. 10	12	3	26.7 mm	10.3 mm	Green	W3W	<i>Not E-approved.</i>
	170778	Pkg. 10	12	3	26.7 mm	10.3 mm	Orange	W3W	<i>Not E-approved.</i>
	170331	Pkg. 10	12	3	26.7 mm	10.3 mm		W3W	
	170754	Pkg. 10	12	5	26.7 mm	10.3 mm	Orange	WY5W	
	170662	Pkg. 10	12	5	26.7 mm	10.3 mm		W5W Longlife	
	170347	Pkg. 10	12	5	26.7 mm	10.3 mm		W5W	
	171027	Pkg. 10	24	2	26.7 mm	10.3 mm		Heavy duty	<i>Not E-approved.</i>
	170476	Pkg. 10	24	3	26.7 mm	10.3 mm		W3W Heavy duty	
	170805	Pkg. 10	24	3	26.7 mm	10.3 mm	Orange	W3W Heavy duty	<i>Not E-approved.</i>
	170806	Pkg. 10	24	3	26.7 mm	10.3 mm	Green	W3W Heavy duty	
	170808	Pkg. 10	24	3	26.7 mm	10.3 mm	Red	W3W Heavy duty	<i>Not E-approved.</i>
	170542	Pkg. 10	24	5	26.7 mm	10.3 mm		W5W Heavy duty	

Jahn	HC-CARGO	Std. pkg.	Voltage	Watt	Length	OD	Colour	Type	Comment
 T5	170617	Pkg. 10	12	1.2	20 mm	5 mm	Frosted		Not E-approved.
	170410	Pkg. 10	12	1.2	20 mm	5 mm			Not E-approved.
	171283	Pkg. 10	12	2	20 mm	5 mm			Not E-approved.
	170684	Pkg. 10	24	0.7	20 mm	5 mm			
	170477	Pkg. 10	24	1.2	20 mm	5 mm		Heavy duty	Not E-approved.
WEDGE BASE - COVERS									
Jahn	HC-CARGO	Std. pkg.	Voltage	Watt	Length	OD	Colour	Type	Comment
 	171129	Pkg. 10			10.5 mm	7 mm	Green		Not E-approved.
	171128	Pkg. 10			11 mm	6.5 mm	Blue		Not E-approved.
	170731	Pkg. 25			13.1 mm	9.6 mm	Blue		
	170732	Pkg. 25			13.1 mm	9.6 mm	Green		
FESTOON									
CARGO	HC-CARGO	Std. pkg.	Voltage	Watt	Length	OD	Colour	Type	Comment
 S8.5	171487	Pkg. 10	6	10	36 mm	10.5 mm		Festoon	Not E-approved.
	171094	Pkg. 10	12	5	36 mm	10.5 mm			
	171097	Pkg. 10	12	5	41 mm	10.5 mm			Not E-approved.
	171095	Pkg. 10	12	10	36 mm	10.5 mm			Not E-approved.
	171098	Pkg. 10	12	10	41 mm	10.5 mm			Not E-approved.
	171120	Pkg. 10	12	21	41 mm	15 mm			
	171100	Pkg. 10	24	10	41 mm	10.5 mm		Heavy duty	Not E-approved.
	171096	Pkg. 10	24	5	36 mm	10.5 mm		Heavy duty	
	171099	Pkg. 10	24	5	41 mm	10.5 mm		Heavy duty	Not E-approved.
Jahn	HC-CARGO	Std. pkg.	Voltage	Watt	Length	OD	Colour	Type	Comment
 S6	170591	Pkg. 10	12	3	33 mm	8.5 mm			Not E-approved.
	170590	Pkg. 10	12	3	28 mm	8 mm			Not E-approved.
 S8.5	171479	Pkg. 10	6	18	41 mm	15 mm			Not E-approved.
	171484	Pkg. 10	6	5	36 mm	10.5 mm			
	170341	Pkg. 10	12	5	36 mm	10.5 mm		C5W	
	170343	Pkg. 10	12	5	41 mm	10.5 mm			Not E-approved.
	170005	Pkg. 10	12	10	28 mm	10 mm			Not E-approved.
	170411	Pkg. 10	12	10	36 mm	10.5 mm			Not E-approved.
	170344	Pkg. 10	12	10	41 mm	10.5 mm			Not E-approved.
	170342	Pkg. 10	12	15	41 mm	15 mm			Not E-approved.
	170588	Pkg. 10	12	18	41 mm	15 mm			Not E-approved.
	171139	Pkg. 10	12	21	41 mm	15 mm			
	170414	Pkg. 10	24	5	36 mm	10.5 mm		C5W Heavy duty	
	170592	Pkg. 10	24	15	41 mm	15 mm		Heavy duty	Not E-approved.
	170589	Pkg. 10	24	18	41 mm	15 mm		Heavy duty	Not E-approved.

CONVENTIONAL

	HC-CARGO	Std. pkg.	Voltage	Watt	Length	OD	Colour	Type	Comment
 BA15S	171991	Pkg. 10	12	45	53 mm	36 mm			For US and UK systems. Not E-approved.
	171978	Pkg. 1	24	45	53 mm	36 mm		Heavy duty	For US and UK systems. Not E-approved.
 BA20d	171977	Pkg. 1	6	35/35	70 mm	36 mm			Not E-approved.
	171985	Pkg. 1	12	25/25	70 mm	36 mm			
	171975	Pkg. 1	12	35/35	70 mm	36 mm			
	171974	Pkg. 1	12	45/40	70 mm	36 mm			Not E-approved.
	171976	Pkg. 1	24	45/40	70 mm	36 mm		Heavy duty	Not E-approved.
 P45t	170771	Pkg. 1	12	45/40	77 mm	41 mm		Bilux	
 PG20/4	171869	Pkg. 1	12	24	47.75 mm	18.5 mm	Orange		300 lm.
 PGU20/4	172074	Pkg. 1	12	24	46.55 mm	18.5 mm	Orange		

	HC-CARGO	Std. pkg.	Voltage	Watt	Length	OD	Colour	Type	Comment
 BA20s	170575	Pkg. 1	12	35	66 mm	36 mm			Not E-approved.
	170579	Pkg. 1	12	50	66 mm	36 mm			For German and Italian systems. Not E-approved.
 P26s	170816	Pkg. 10	12	15	46 mm	25.5 mm			
 P45t	171477	Pkg. 1	6	45/40	77 mm	41 mm		Bilux	
	170338	Pkg. 1	12	45/40	77 mm	41 mm		Bilux	
	170350	Pkg. 1	24	55/50	77 mm	41 mm		Bilux Heavy duty	

INSTRUMENT PANEL

	HC-CARGO	Std. pkg.	Voltage	Watt	Length	OD	Colour	Socket colour	Comment
 B8.4d	171109	Pkg. 10	12	1.2	17.5 mm	5 mm		Black	Not E-approved.
	171381	Pkg. 10	12	1.2	17.5 mm	5 mm		Blue	Not E-approved.
	171023	Pkg. 10	12	1.5	17.5 mm	5 mm		Beige	Not E-approved.
	171110	Pkg. 10	12	2	17.5 mm	5 mm		Light green	Not E-approved.
 B8.5d	171380	Pkg. 10	12	0.36	21 mm	5 mm		Purple	Not E-approved.
	171379	Pkg. 10	12	1	21 mm	5 mm		Orange	Not E-approved.
	171024	Pkg. 10	12	1.2	21 mm	5 mm		Blue	Not E-approved.
	171383	Pkg. 10	12	1.5	21 mm	5 mm		Beige	Not E-approved.
	171028	Pkg. 10	24	1.2	21 mm	5 mm		Brown	Not E-approved. Heavy duty
 B8.7d	171455	Pkg. 10	12	2	16.5 mm	5 mm		Green	Not E-approved.

	HC-CARGO	Std. pkg.	Voltage	Watt	Length	OD	Colour	Socket colour	Comment
 BX2d	171284	Pkg. 10	12	1.2	21.5 mm	5 mm		Black	Not E-approved.
 EBSN10	171377	Pkg. 10	24	1.2	20 mm	6 mm		Beige	Alba- type. Not E-approved. Heavy duty
 EBSR11	171031	Pkg. 10	12	1.2	20 mm	5 mm		Green	Alba- type.
	170698	Pkg. 10	12	1.8	20 mm	5 mm		Blue	Alba- type.
	171026	Pkg. 10	24	1.2	21 mm	5 mm		Brown	Alba- type.
	171025	Pkg. 10	24	1.2	21 mm	5 mm		Yellow	Alba- type.
	171032	Pkg. 10	24	1.4	21 mm	5 mm		Green	Alba- type.
 F4.8	171112	Pkg. 10	14	1.4	13 mm	4.8 mm		Black	Not E-approved.
 MFHZ	171382	Pkg. 10	12	1.2	38 mm	5 mm		Black	Not E-approved.
 MFJF	171384	Pkg. 10	12	1.2	35 mm	5 mm		Black	Not E-approved.
 T-1/4	170364	Pkg. 10	14	1.12	10.5 mm	4 mm			
 T-1/4NW	170762	Pkg. 10	14	0.8	9 mm	3.4 mm		Dark grey	
	171389	Pkg. 10	14	1.4	11 mm	3.5 mm		Black	Not E-approved.
 T-3/4	170972	Pkg. 10	12	0.6	6.5 mm	2.5 mm			Used as locating light bulbs in switches on Japanese vehicles.
 T5	171388	Pkg. 10	12	0.4	20 mm	5 mm	Frosted	Grey	Not E-approved.
	171029	Pkg. 10	24	1.2	20 mm	5 mm		White	
 T7	171111	Pkg. 10	14	2	23 mm	7 mm		Pink	Not E-approved.
John	HC-CARGO	Std. pkg.	Voltage	Watt	Length	OD	Colour	Socket colour	Comment
 B8.3d	170612	Pkg. 10	12	1.2	23.5 mm	5 mm		Black	Not E-approved.
	170611	Pkg. 10	12	2	23.5 mm	5 mm		White	Not E-approved.
	170613	Pkg. 10	24	1.2	23.5 mm	5 mm		Grey	Not E-approved. Heavy duty
 B8.4d	171033	Pkg. 10	12	1.12	17.5 mm	5 mm		Orange	Not E-approved.
	170727	Pkg. 10	12	1.2	17.5 mm	5 mm		Black	Not E-approved.
	170756	Pkg. 10	12	2	17.5 mm	5 mm		Light green	Not E-approved.

John	HC-CARGO	Std. pkg.	Voltage	Watt	Length	OD	Colour	Socket colour	Comment
 B8.5d	170357	Pkg. 10	12	1.2	23.5 mm	5 mm		Black	Not E-approved.
	170610	Pkg. 10	12	2	23.5 mm	5 mm		Green	Not E-approved.
	170358	Pkg. 10	24	1.2	23.5 mm	5 mm		Grey	Not E-approved. Heavy duty
 B8.7d	170545	Pkg. 10	12	1.2	23.5 mm	5 mm		Grey	Not E-approved.
 F4.8	170753	Pkg. 10	14	1.4	12 mm	5 mm		Black	Not E-approved.
 T7	170755	Pkg. 10	12	0.5	19.5 mm	5 mm		Grey	Not E-approved.
	170758	Pkg. 10	12	1.2	20 mm	5 mm		White	Not E-approved.
	170782	Pkg. 10	12	1.2	20 mm	5 mm		Orange	Not E-approved.
	170783	Pkg. 10	12	1.2	20 mm	5 mm		Green	Not E-approved.
	170785	Pkg. 10	12	1.2	20 mm	5 mm		Red	Not E-approved.
170757	Pkg. 10	14	2	23.5 mm	5 mm		Pink	Not E-approved.	

HALOGEN

John	HC-CARGO	Std. pkg.	Voltage	Watt	Length	OD	Colour	Type	Comment
 BA15S	171987	Pkg. 10	12	10	37.5 mm	10 mm			Not E-approved.
 BA9s	170470	Pkg. 10	12	5	33 mm	9 mm			Not E-approved.
	170380	Pkg. 10	12	20	35 mm	9 mm			Not E-approved.
 G4	171425	Pkg. 10	12	5	30 mm	8 mm			
	170712	Pkg. 10	12	10	30 mm	8 mm			
	170749	Pkg. 10	12	20	30 mm	8 mm			
	170848	Pkg. 10	24	10	30 mm	8 mm			
	170750	Pkg. 10	24	20	30 mm	8 mm			
 T10	171124	Pkg. 10	12	5	33 mm	9 mm			Not E-approved.

John	HC-CARGO	Std. pkg.	Voltage	Watt	Length	OD	Colour	Type	Comment
 B10d	170751	Pkg. 10	12	3	27.8 mm	8.8 mm	Brown		Not E-approved.
	170752	Pkg. 1	12	5	27.8 mm	8.8 mm	Black		Not E-approved.

ELECTRIC VEHICLES AND FORKLIFTS

John	HC-CARGO	Std. pkg.	Voltage	Watt	Length	OD	Colour	Type	Comment
 BA15S	171410	Pkg. 10	48	10	35 mm	16 mm			Not E-approved.
	171408	Pkg. 10	48	25	50 mm	25 mm			Not E-approved.
 BAY15d	171411	Pkg. 10	48	25/10	50 mm	25 mm			Not E-approved.

	HC-CARGO	Std. pkg.	Voltage	Watt	Length	OD	Colour	Type	Comment
 PK22s	171407	Pkg. 1	48	45	42 mm	11.5 mm		Halogen H3	<i>Not E-approved.</i>
	171378	Pkg. 1	80	55	42 mm	11.5 mm		Halogen H3	<i>Not E-approved.</i>

FLASH AND PENLIGHT

	HC-CARGO	Std. pkg.	Voltage	Watt	Length	OD	Colour	Type	Comment
 E10	170509	Pkg. 10	12	3	24 mm	11.5 mm			
 P13.5s	171280	Pkg. 10	4.8	3.6	30 mm	11 mm		Krypton	

LED

	HC-CARGO	Std. pkg.	Voltage	Watt	Length	OD	Colour	Type	Comment
 BA15S	172162	Pkg. 1	12	1.3			Yellow		<i>Not E-approved.</i>
	172163	Pkg. 1	24	0.7			White		<i>Not E-approved.</i>
	172164	Pkg. 1	24	0.7			White		<i>Not E-approved.</i>
	172165	Pkg. 1	24	0.7			Red		<i>Not E-approved.</i>
	172166	Pkg. 1	24	0.7			Yellow		<i>Not E-approved.</i>
 BA9s	172170	Pkg. 1	12	0.4			White		<i>Not E-approved.</i>
	172171	Pkg. 1	24	0.2			White		<i>Not E-approved.</i>
 BAX9s	172182	Pkg. 1	12	2.3			White		<i>CANBUS.</i> <i>Not E-approved.</i>
 BAY15d	172167	Pkg. 1	12	1.3			Red		<i>Not E-approved.</i>
	172168	Pkg. 1	12	1.3			White		<i>Not E-approved.</i>
	172169	Pkg. 1	24	0.7			White		<i>Not E-approved.</i>
 KW2.1x9.5d	172176	Pkg. 1	24	0.1			Yellow		<i>Not E-approved.</i>
	172174	Pkg. 1	24	0.2			Red		<i>Not E-approved.</i>
	172175	Pkg. 1	24	0.2			White		<i>Not E-approved.</i>
 SV8.5	172179	Pkg. 1	12	0.2	38 mm	11 mm	Red		<i>Not E-approved.</i>
	172181	Pkg. 1	12	0.2	38 mm	11 mm	White		<i>Not E-approved.</i>
	172180	Pkg. 1	12	2	38 mm	11 mm	Blue		<i>Not E-approved.</i>
	172178	Pkg. 1	24	0.1	38 mm	11 mm	White		<i>Not E-approved.</i>
	172177	Pkg. 1	24	1	38 mm	11 mm	Red		<i>Not E-approved.</i>
 W2.1x9.5d	172173	Pkg. 1	12	0.2			Yellow		<i>Not E-approved.</i>
	172172	Pkg. 1	12	0.4			White		<i>Not E-approved.</i>
	HC-CARGO	Std. pkg.	Voltage	Watt	Length	OD	Colour	Type	Comment
 BA15S	172159	Pkg. 1	12	0.4			White		<i>Not E-approved.</i>
	172158	Pkg. 1	12	0.4			Red		<i>Not E-approved.</i>
	172157	Pkg. 1	12	1.3			Yellow		<i>Not E-approved.</i>
	172160	Pkg. 1	12	1.3			White		<i>Not E-approved.</i>
	172161	Pkg. 1	12	1.3			Red		<i>Not E-approved.</i>

SPARE LAMP KITS
FOR CARS
Jahn

171040



171042



171043

Dimensions: 90 x 90 x 57 mm.

Contains:

HC-CARGO	TYPE	Jahn Ref. No.	Description	H4 171040	H7 171042	H1/H7 171043
170804	H4	1134	12 V. 60/55 W. P43t.	1		
170332	H1	1111	12 V. 55 W. P14.5s.		1	
170720	H7	1117	12 V. 55 W. PX 26d.		1	1
170335	P12W	1321	12 V. 21 W. BAY15s.	1	1	1
170336	P21/5W	1341	12 V. 21/5W. BAY15d.	1	1	1
170648	PY21W	1383	12 V. 21W. BAU15s.		1	1
170347	W5W	1621	12 V. 5 W. W2.1 x 9.5d.		1	1
170340	R5W	1401	12 V. 5 W. BA15s.	1	1	
170341	C5W	1711	12 V. 5 W. SV8.5.		1	1
170346	T4W	1501	12 V. 5 W. SV8.5.	1		
190057	ATO blade fuse		10 Amp. Red.	1	1	1
190058	ATO blade fuse		15 Amp. Blue.	1	1	1
190059	ATO blade fuse		20 Amp. Yellow.	1	1	1

FOR TRUCKS AND BUSES
Jahn

Contains:

HC-CARGO	TYPE	Jahn Ref. No.	Description	H4 171044
170348	H4	1102	24 V. 75/70W P43t.	2
170417	T4W	1502	24 V. 4 W. BA9s.	2
170413	R5W	1402	24 V. 5 W. BA15s.	1
170351	R10W	1412	24 V. 10 W. BA15s.	1
170349	P21W	1322	24 V. 21 W. BA15s.	4
170416	T2W	1512	24 V. 2 W. BA9s.	2
170475	Fest. T10.5	1732	24 V. 10 W. SV8.5.	1
170414	C5W	1712	24 V. 5 W. SV8.5.	1
190057	ATO blade fuse		10 Amp. Red.	1
190058	ATO blade fuse		15 Amp. Blue.	1
190059	ATO blade fuse		20 Amp. Yellow.	1
190060	ATO blade fuse		25 Amp. Natural.	1



171044

Dimensions: 210 x 95 x 60 mm.



Assortments

Edition 2018/2019



Festoon Bulbs 12 V

809002

	Qty.
170005 .. Bulb Pinol, 12V, 10W, 10x28...	20
170344 .. Bulb Pinol, 12V, 10W, 10.5x4...	20
170343 .. Bulb Pinol, 12V, 5W, 10.5x41...	20
170341 .. Bulb Pinol, 12V, 5W, 10.5x36...	20
170411 .. Bulb Pinol, 12V, 10W, 10.5x3...	20
170588 .. Bulb Pinol, 12V, 18W, 15x41...	20
170590 .. Bulb Pinol, 12V, 3W, 8x28.....	20
170591 .. Bulb Pinol, 12V, 3W, 8.5x33 ...	20



Wedge-Base Bulbs 12 V - I

809003

	Qty.
170331 .. Bulb, T10, 12V, 3W	20
170347 .. Bulb, T10, 12V, 5W	20
170357 .. Bulb, B8.5d, 12V, 1.2W	20
170410 .. Bulb, T5, 12V, 1.2W	20
170545 .. Bulb, B8.7d, 12V, 1.2W	20
170610 .. Bulb, B8.5d, 12V, 2W.....	10
170612 .. Bulb, B8.3d, 12V, 1.2W	10
170611 .. Bulb, B8.3d, 12V, 2W.....	10
170617 .. Bulb, T5, 12V, 1.2W, Frosted..	10
170698 .. Bulb, EBSR11, 12V, 1.8W	10
170364 .. Bulb, T-1/4, 14V, 1.12W	20



Wedge-Base Bulbs 12 V - II

809005

	Qty.		Qty.
170410 .. Bulb, T5, 12V, 1.2W	10	170698 .. Bulb, EBSR11, 12V, 1.8W	5
170727 .. Bulb, B8.4d, 12V, 1.2W	5	170757 .. Bulb, 14V, 2W	5
170617 .. Bulb, T5, 12V, 1.2W, Frosted..	10	170762 .. Bulb, T-1/4NW, 14V, 0.8W	5
170611 .. Bulb, B8.3d, 12V, 2W	10	170732 .. Bulb Cover	10
170758 .. Bulb, T5, 12V, 1.2W	5	170755 .. Bulb, T5, 12V, 0.5W	5
170756 .. Bulb, B8.4d, 12V, 2W.....	5	170347 .. Bulb, T10, 12V, 5W	10
170357 .. Bulb, B8.5d, 12V, 1.2W	10	170331 .. Bulb, T10, 12V, 3W	10
170545 .. Bulb, B8.7d, 12V, 1.2W	10	170364 .. Bulb, T-1/4, 14V, 1.12W	10
170610 .. Bulb, B8.5d, 12V, 2W.....	10	170731 .. Bulb Cover	10
170753 .. Bulb, F4.8, 14V, 1.4W	5	170751 .. Bulb, B10d, 12V, 3W.....	5
170612 .. Bulb, B8.3d, 12V, 1.2W	10		
170752 .. Bulb, B10d, 12V, 5W.....	5		
170754 .. Bulb, T10, 12V, 5W	5		
170972 .. Bulb, T-3/4, 12V, 0.6W.....	10		



Wedge-base Bulbs 12 V - III

809009

	Qty.		Qty.
171379 .. Bulb, B8.5d, 12V, 1W.....	10	171391 .. Bulb, T7, 12V, 3W.....	10
171380 .. Bulb, B8.5d, 12V, 0.36W	10	170545 .. Bulb, B8.7d, 12V, 1.2W	10
171381 .. Bulb, B8.4d, 12V, 1.2W	10		
171382 .. Bulb, MFHZ, 12V, 1.2W.....	10		
171383 .. Bulb, B8.5d, 12V, 1.5W	10		
171384 .. Bulb, MFJF, 12V, 1.2W.....	10		
171455 .. Bulb, B8.7d, 12V, 1.2W	10		
171024 .. Bulb, B8.5d, 12V, 1.2W	10		
171388 .. Bulb, T5, 12V, 0.4W	10		
171023 .. Bulb, B8.4d, 12V, 1.5W	10		
171389 .. Bulb, T-1/4NW, 14V, 1.4W.....	10		
171284 .. Bulb, BX2d, 12V, 1.2W	10		
171031 .. Bulb, EBSR11, 12V, 1.2W	10		
171033 .. Bulb, B8.4d, 12V, 1.12W.....	10		



Wedge-Base Bulbs 24 V

809004

	Qty.		Qty.
170358 .. Bulb, B8.5d, 24V, 1.2W	10	171029 .. Bulb, T5, 24V, 1.2W	10
170476 .. Bulb, T10, 24V, 3W	10	171032 .. Bulb, EBSR11, 24V, 1.4W	10
170477 .. Bulb, T5, 24V, 1.2W	10		
170542 .. Bulb, T10, 24V, 5W	10		
170613 .. Bulb, B8.3d, 24V, 1.2W	10		
170684 .. Bulb, T5, 24V, 0.7W	10		
170805 .. Bulb, T10, 24V, 3W	10		
171026 .. Bulb, EBSR11, 24V, 1.2W	10		
170806 .. Bulb, T10, 24V, 3W	10		
170807 .. Bulb, T10, 24V, 3W	10		
170808 .. Bulb, T10, 24V, 3W	10		
171025 .. Bulb, EBSR11, 24V, 1.2W	20		
171027 .. Bulb, T10, 24V, 2W	10		
171028 .. Bulb, B8.5d, 24V, 1.2W	10		





Electrical Components

Edition 2018/2019



CAMERA & PARKING SENSORS

CCTV REAR OBSERVATION SYSTEM

160775 Rear Observation Kit Std pkg 1

Kit consisting of 1x7" monitor w/ quad: HC-CARGO 160776. 1x colour camera w/ audio: HC-CARGO 161127. 1x20 m extension cable: HC-CARGO 160611. Accessories: HC-CARGO 160610, 160612, 160613, 160672, 160880, 160993, 160784.



Voltage: 12/24

Extension cable: 20 m

Height: 140 mm
Depth: 50.8 mm
Display size: 7"
Width: 191 mm
Wide angle: 60°

Monitor: LED
Type: Camera kit
Camera type: Colour
Accessories: DVD
No./cameras: 4+1
Audio: Yes
Extra camera: w/
Infrared: w/
Split screen: Yes
Language: English

160783 Rear Observation Kit Std pkg 1

Kit consisting of 1x7" monitor: HC-CARGO 160784. 1x colour camera: HC-CARGO 161127. 1x20 m extension cable: HC-CARGO 160611. Accessories: HC-CARGO 160610, 160612, 160613, 160672, 160880, 160776, 160993.



Voltage: 12/24

Extension cable: 20 m

Height: 140 mm
Depth: 50.8 mm
Display size: 7"
Width: 191 mm
Wide angle: 60°

Monitor: LED
Type: Camera kit
Camera type: Colour
Accessories: DVD
No./cameras: 3+1
Remote control: w/o
Audio: Yes
Extra camera: w/
Infrared: w/
Language: English

160793 Rear View Mirror Monitor kit Std pkg 1

w/o camera and extension cable. Camera: HC-CARGO 160610, 160880, 161038. Extension cables use: HC-CARGO 160611, 160612, 160613, 160672.



Voltage: 12/24

Display size: 4.3"

Camera type: Colour
Accessories: DVD
Audio: Yes

160994 Rear Observation Kit Std pkg 1

Consists: 1x7" monitor w/ remote control: HC-CARGO 160995. 1x colour camera: HC-CARGO 161043. 1x20 m extension cable: HC-CARGO 160888. Accessories: HC-CARGO 160889, 160916, 160972, 161006, 161029, 161030, 161041, 161056, 161057.



Voltage: 12-24

Extension cable: 20 m

Display size: 7"
Wide angle: 120°

Monitor: TFT-LCD
Type: Camera kit
Camera type: Colour
No./cameras: max. 2
Remote control: w/
Audio: Yes
Infrared: w/
Language: Chinese, German, English, French, Dutch, Italian, Spanish, Danish, Russian, Polish
Alternativ no.: 161046

160996 Back camera 5" Std pkg 1

Consists: 1x5" monitor w/ remote control: HC-CARGO 161040. 1x colour camera: HC-CARGO 161043. 1x20 m extension cable: HC-CARGO 160888. Accessories: HC-CARGO 160889, 160916, 160972, 161030, 161065, 161057, 161006, 161029, 161041.



Voltage: 12-24

Extension cable: 20 m

Display size: 5"
Wide angle: 120°

Monitor: TFT-LCD
Type: Camera kit
Camera type: Colour
No./cameras: max. 2
Remote control: w/
Audio: Yes
Infrared: w/
Language: Chinese, German, English, French, Dutch, Italian, Japanese, Portuguese, Spanish
Alternativ no.: 161039

161005 Rear Observation Kit Std pkg 1



Voltage: 12
Frequency: 2.4

Display size: 3.5"
Max wide transmission range: 30 m
Wide angle: 170°

Monitor: TFT-LCD
Type: Camera kit
Camera type: Colour - Wireless
No./cameras: 1
Audio: No
Infrared: w/o
Language: Chinese, German, English, French, Dutch, Italian, Japanese, Portuguese, Spanish

		EL. SPECIFICATIONS	DIMENSIONS	ADDITIONAL SPECIFICATIONS
161039 Rear Observation Kit Std pkg 1 Monitor Mounting, w/suction Cup: HC-CARGO 161044. Consists: 1x5" monitor: HC-CARGO 161040. 1x colour camera: HC-CARGO 161043. 1x20 m extension cable: HC-CARGO 160888. Accessories: HC-CARGO 161006, 161029, 161030, 161041, 161047, 161056, 161057, 160889, 160972, 160916.		Voltage: 12-24	Extension cable: 20 m Display size: 5" Wide angle: 120°	Monitor: TFT-LCD Type: Camera kit Camera type: Colour No./cameras: max. 2 Remote control: w/ Audio: Yes Infrared: w/ Language: Chinese, German, English, French, Dutch, Italian, Portuguese, Spanish, Danish, Russian, Polish
161046 Rear Observation Kit Std pkg 1 Monitor Mounting, w/suction Cup: HC-CARGO 161044. Consists: 1x7" monitor: HC-CARGO 161047. 1x colour camera: HC-CARGO 161043. 1x15 m extension cable. Accessories: HC-CARGO 161006, 161029, 161030, 161040, 161041, 161056, 161057, 160888. 160889.		Voltage: 12-24	Extension cable: 15 m Display size: 7" Wide angle: 120°	Monitor: TFT-LCD Type: Camera kit Camera type: Colour No./cameras: max. 2 Audio: Yes Infrared: w/ Language: Chinese, German, English, French, Dutch, Italian, Portuguese, Spanish, Danish, Russian, Polish
161048 Rear Observation Kit Std pkg 1 Monitor Mounting, w/suction Cup: HC-CARGO 161044. Consists: 1x7" monitor: HC-CARGO 161049. 2x colour camera: HC-CARGO 161050. Accessories: HC-CARGO 161036, 161033.		Voltage: 12-24 Frequency: 2.4	Display size: 7" Max wide transmission range: 30 m Wide angle: 120°	Monitor: TFT-LCD Type: Camera kit Camera type: Colour - Wireless No./cameras: 2 Audio: Yes Infrared: w/ Split screen: Yes Language: English
161051 Rear Observation Kit Std pkg 1 Monitor Mounting, w/suction Cup: HC-CARGO 161044. Consists: 1x7" monitor: HC-CARGO 161052. 1x colour camera: HC-CARGO 161043. 1x20 m extension cable: HC-CARGO 160888. Accessories: HC-CARGO 161006, 161029, 161030, 161041, 161056, 161057, 160889, 161053, 160916.		Voltage: 12-24	Extension cable: 20 m Display size: 7" Wide angle: 120°	Monitor: TFT-LCD Type: Camera kit Camera type: Colour No./cameras: max. 4 Remote control: w/ Audio: Yes Infrared: w/ Split screen: Yes Tightness norm: IP 69K (Camera) Language: Chinese, German, English, French, Dutch, Italian, Spanish, Danish, Russian, Polish
161054 Rear Observation Kit Std pkg 1 Monitor Mounting, w/suction Cup: HC-CARGO 161044. Aerial: HC-CARGO 161036. Consists: 1x5" monitor: HC-CARGO 161055. 2x colour camera: HC-CARGO 161058.		Voltage: 12-24	Display size: 5" Max wide transmission range: 30 m Wide angle: 120°	Monitor: TFT-LCD Type: Camera kit Camera type: Colour - Wireless No./cameras: 2 Audio: Yes Infrared: w/ Split screen: Yes Tightness norm: IP 69K (Camera) Language: English
161720 Camera Kit for Forklift Std pkg 1 Consists: 1x7" monitor: HC-CARGO 161723, 1x Camera: HC-CARGO 161721, 2x Magnet: HC-CARGO 161724, 1x Power pack: HC-CARGO 161722. Accessories: HC-CARGO 161733, 161730, 161036, 161725, 161044, 161732, 161731.		Voltage: 8-32 Frequency: 2.4	Height: 75 mm Depth: 70.4 mm Display size: 7" Width: 106 mm Max wide transmission range: 30 m Resolution: 800x480 pixels Wide angle: 120°	Monitor: TFT-LCD Type: Camera kit Camera type: Colour - Wireless No./cameras: 1 Remote control: w/o Audio: Yes Infrared: w/ Split screen: Yes Tightness norm: IP 69K (Camera) Language: English

161726 Rear Observation Kit Std pkg 1

16GB SD card. Consists: 1x7" monitor: HC-CARGO 161727, 4x Camera: HC-CARGO 161721. Accessories: HC-CARGO 161733, 161730, 161036, 161725, 161044, 161732, 161731.

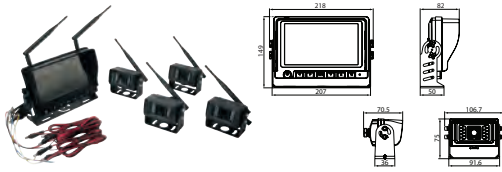

Voltage: 8-32
Frequency: 2.4

Display size: 7"
Max wide transmission range: 30 m
Resolution: 800x480 pixels
Wide angle: 120°

Monitor: TFT-LCD
Type: Camera kit
Camera type: Colour - Wireless
No./cameras: 4
Remote control: w/o
Audio: Yes
Infrared: w/
Split screen: Yes
Tightness norm: IP 69K (Camera)
Language: English

161728 Rear Observation Kit Std pkg 1

16GB SD card. Consists: 1x9" monitor: HC-CARGO 161729, 4x Camera: HC-CARGO 161721. Accessories: HC-CARGO 161733, 161730, 161036, 161725, 161044, 161732, 161731.

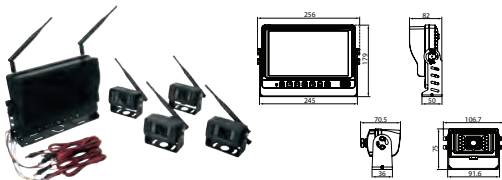

Voltage: 8-32
Frequency: 2.4

Display size: 9"
Max wide transmission range: 30 m
Resolution: 800X480 pixels
Wide angle: 120°

Monitor: TFT-LCD
Type: Camera kit
Camera type: Colour - Wireless
No./cameras: 4
Remote control: w/o
Audio: Yes
Infrared: w/
Split screen: Yes
Tightness norm: IP 69K (Camera)
Language: English

CAMERAS
160610 CCTV Camera Std pkg 1 Servicing: HC-CARGO 160775, 160783, 160793

w/ original anoised finish and anti-fog glas. Lens: HC-CARGO 160965, 161037.



Voltage: 12
Light sensitivity: 0.2 lux

OD: 30 mm
Length: 70 mm
Connection cable: 6 pin mini DIN
Resolution: >330 TV lines
Shutter rate: 1/50-1/100.000 sec.
Wide angle: 130°

Signal system: PAL
Type: Colour
Colour: Black
Material: Aluminium
Picture sensor: 1/3" CCD
Microphone: w/o
Audio: No
Mirror function: w/
Connection cable: 6 pin mini DIN
Protection degree: IP 66

160880 Side Camera Std pkg 1 Servicing: HC-CARGO 160775, 160783

Voltage: 12
Light sensitivity: 0/ IR LED on lux

Connection cable: Mini DIN 6 pin - 2 m
Height: 60.7 mm
Depth: 82.6 mm
Width: 61.12 mm
Resolution: 380 TV lines
Shutter rate: 1/60-1/100.000 sec.
Wide angle: 73°

Signal system: PAL
Type: Colour
Colour: Black
Material: Aluminium
Picture sensor: 1/4" CCD
Microphone: w/o
Audio: No
Infrared: w/
Mirror function: w/
Connection cable: Mini DIN 6 pin - 2 m
Protection degree: IP 67

160972 Colour Camera Std pkg 1 Servicing: HC-CARGO 160994, 160996

Voltage: 12/24
Light sensitivity: 0 lux

Connection cable: 0.3 m 4 pin
Height: 43 mm
Depth: 57 mm
Width: 75 mm
Resolution: 480 TV lines
Wide angle: 95°

Signal system: PAL/NTSC
Type: Colour
Colour: Black
Material: Aluminium
Picture sensor: 1/3" CCD
Microphone: w/
Audio: Yes
Infrared: w/
Mirror function: w/
Connection cable: 0.3 m 4 pin
Protection degree: IP 68
Alternativ no.: 161043

161006 Colour Camera w/ auto close Std pkg 1 Servicing: HC-CARGO 160994, 161007, 161039, 161046, 161051

Voltage: 12/24
Light sensitivity: 0 lux

Connection cable: 0.5 m 4 pin
Resolution: 420 TV lines
Wide angle: 140°

Signal system: PAL/NTSC
Type: Colour
Colour: Black
Material: Aluminium
Picture sensor: 1/3" CCD
Microphone: w/o
Audio: No
Infrared: w/
Connection cable: 0.5 m 4 pin
Protection degree: IP 68

		EL. SPECIFICATIONS	DIMENSIONS	ADDITIONAL SPECIFICATIONS
161029 Colour Camera				
Std pkg 1		Servicing: HC-CARGO 160994, 161007, 161039, 161046, 161051		
w/ heat.				
		Voltage: 12-24 Light sensitivity: 0 lux	Connection cable: 4 pin Height: 77.2 mm Depth: 66 mm Width: 77.2 mm Resolution: 420 TV lines Wide angle: 120°	Signal system: PAL Type: Colour Colour: Black Material: Aluminium Picture sensor: 1/3" CCD Microphone: w/o Audio: No Infrared: w/ Mirror function: w/ Connection cable: 4 pin Protection degree: IP 69K
161030 Side Camera				
Std pkg 1		Servicing: HC-CARGO 160994, 161007, 161039, 161046, 161051		
		Voltage: 12 Light sensitivity: 0 lux	Connection cable: 4 pin Height: 60 mm Depth: 90 mm Width: 75 mm Resolution: 420 TV lines Wide angle: 120°	Signal system: PAL Type: Colour Colour: Black Material: Aluminium Picture sensor: 1/3" CCD Microphone: w/o Audio: No Infrared: w/ Mirror function: w/o Connection cable: 4 pin Protection degree: IP 69K
161033 Colour Camera				
Std pkg 1		Servicing: HC-CARGO 161048		
Aerial: HC-CARGO 161036.				
		Voltage: 12-24 Light sensitivity: 0 lux	Connection cable: 4 pin Height: 75 mm Depth: 70.5 mm Width: 106.7 mm Resolution: 420 TV lines Wide angle: 120°	Signal system: PAL/NTSC Type: Colour - Wireless Colour: Black Material: Aluminium Picture sensor: 1/4" CMOS Microphone: w/o Audio: No Infrared: w/ Mirror function: w/ Connection cable: 4 pin Protection degree: IP 69K Alternativ no.: 161050
161041 Colour camera for roof mounting				
Std pkg 1		Servicing: HC-CARGO 160994, 161007, 161039, 161046, 161051		
		Voltage: 12 Light sensitivity: 0 lux	Connection cable: 0.35 m 4 pin Height: 80 mm Depth: 215 mm Width: 135 mm Resolution: 420 TV lines Wide angle: 120°	Signal system: PAL/NTSC Type: Colour Colour: Black Material: Aluminium Picture sensor: 1/3" CCD Microphone: w/o Audio: No Infrared: w/ Mirror function: w/o Connection cable: 0.35 m 4 pin Protection degree: IP 69K
161043 Colour Camera				
Std pkg 1		Servicing: HC-CARGO 160994, 161007, 161039, 161046, 161051, 160996		
		Voltage: 12 Light sensitivity: 0 lux	Connection cable: 4 pin Height: 70 mm Depth: 84 mm Width: 76 mm Resolution: 420 TV lines Wide angle: 120°	Signal system: PAL Type: Colour Colour: Black Material: Aluminium Picture sensor: 1/3" CCD Microphone: w/ Audio: Yes Infrared: w/ Connection cable: 4 pin Protection degree: IP 69K
161050 Colour Camera				
Std pkg 1		Servicing: HC-CARGO 161048		
Aerial: HC-CARGO 161036.				
		Voltage: 12-24 Light sensitivity: 0 lux	Connection cable: 4 pin Height: 75 mm Depth: 70.5 mm Width: 106.7 mm Resolution: 420 TV lines Wide angle: 120°	Signal system: PAL/NTSC Type: Colour - Wireless Colour: Black Material: Aluminium Picture sensor: 1/4" CMOS Microphone: w/ Audio: Yes Infrared: w/ Mirror function: w/ Connection cable: 4 pin Protection degree: IP 69K

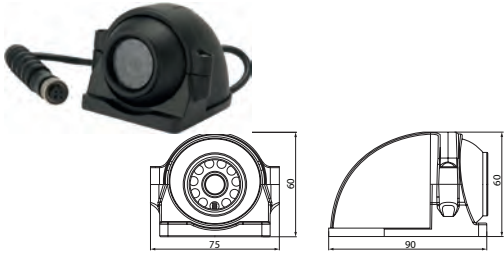
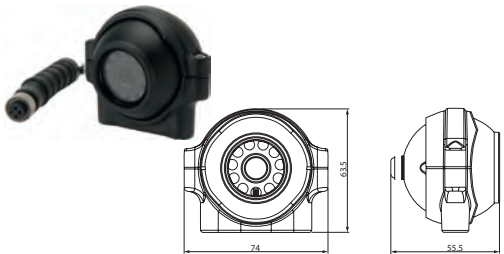
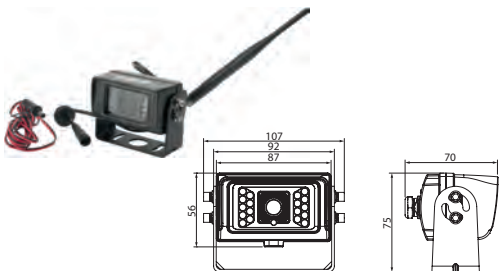
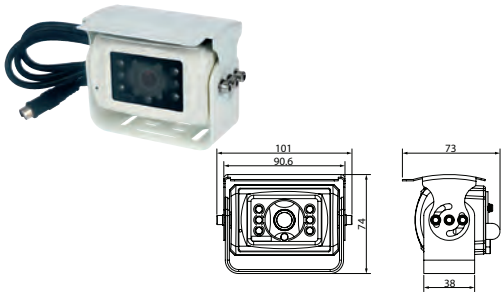
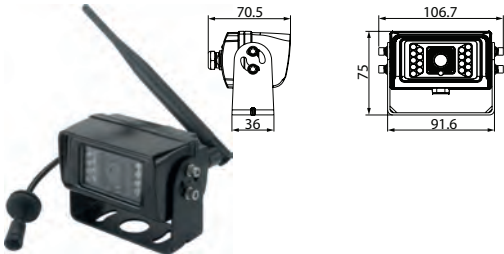
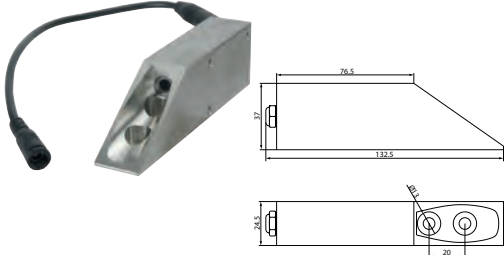



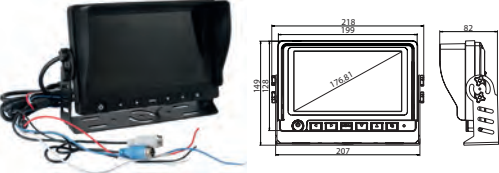
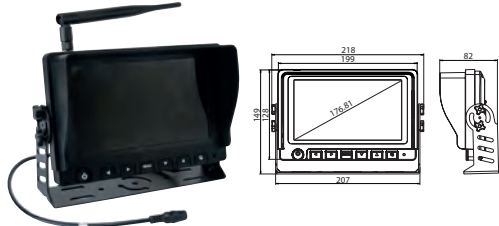
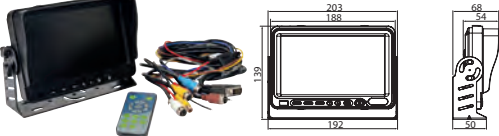
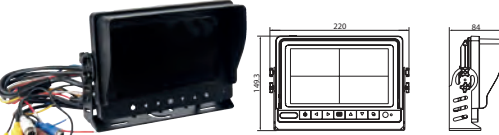
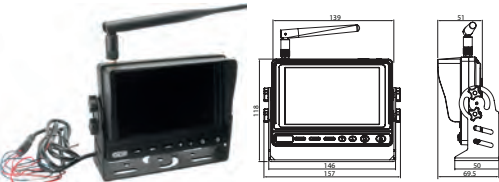

		EL. SPECIFICATIONS	DIMENSIONS	ADDITIONAL SPECIFICATIONS
161056 Side Camera Std pkg 1 Servicing: HC-CARGO 160994, 161007, 161039, 161046, 161051				
		Voltage: 12 Light sensitivity: 0 lux	Connection cable: 4 pin Height: 60 mm Depth: 90 mm Width: 75 mm Resolution: 330 TV lines Wide angle: 130°	Signal system: PAL Type: Colour Colour: Black Picture sensor: 1/3" CMOS Microphone: w/o Infrared: w/ Mirror function: w/o Connection cable: 4 pin Protection degree: IP 69K
161057 Side Camera Std pkg 1 Servicing: HC-CARGO 160994, 161007, 161039, 161046, 161051				
		Voltage: 12 Light sensitivity: 0 lux	Connection cable: 4 pin Height: 63.5 mm Depth: 55.5 mm Width: 74 mm Resolution: 330 TV lines Wide angle: 130°	Signal system: PAL Type: Colour Colour: Black Picture sensor: 1/3" CMOS Microphone: w/o Infrared: w/ Mirror function: w/o Connection cable: 4 pin Protection degree: IP 69K
161058 Colour Camera Std pkg 1 Servicing: HC-CARGO 161054				
<i>Aerial: HC-CARGO 161036.</i>				
		Voltage: 12-24 Light sensitivity: 0 lux	Connection cable: 4 pin Height: 75 mm Depth: 70 mm Width: 107 mm Resolution: 500 TV lines Wide angle: 120°	Signal system: PAL/NTSC Type: Colour - Wireless Colour: Black Material: Aluminium Picture sensor: 1/3" CMOS Microphone: w/ Audio: No Infrared: w/ Mirror function: w/ Connection cable: 4 pin Protection degree: IP 69K
161127 Colour Camera w/ Audio Std pkg 1 Servicing: HC-CARGO 160775, 160783				
		Voltage: 12 Light sensitivity: 1.5 lux	Connection cable: 6 pin mini DIN Height: 74 mm Depth: 73 mm Width: 90.6 mm Resolution: 700 TV lines Shutter rate: 1/60-1/100.000 sec. Wide angle: 122°	Signal system: PAL Type: Colour Colour: White Material: Aluminium Picture sensor: 1/3.2 CCD Microphone: w/ Audio: Yes Infrared: w/ Mirror function: w/ Connection cable: 6 pin mini DIN Protection degree: IP 68 Alternativ no.: 161038
161721 Camera Std pkg 1 Servicing: HC-CARGO 161720, 161726, 161728				
		Voltage: 11-32 Light sensitivity: 0 lux	Height: 75 mm Depth: 70.5 mm Width: 106 mm Resolution: 600 TV lines Wide angle: 120°	Signal system: PAL/NTSC Type: Colour - Wireless Colour: Black Material: Aluminium Picture sensor: 1/3" CMOS Microphone: w/ Audio: Yes Infrared: Yes Protection degree: IP 69K
161733 Camera Std pkg 1 Servicing: HC-CARGO 161720, 161726, 161728				
		Voltage: 12/24 Light sensitivity: 1 lux	Height: 37 mm Depth: 124 mm Width: 25 mm Resolution: 600 TV lines Wide angle: 50°	Signal system: PAL/NTSC Type: Colour - Wireless Colour: Silver Material: Steel Picture sensor: 1/3" CMOS Microphone: w/ Audio: Yes Infrared: Yes Protection degree: IP 67

MONITORS			EL. SPECIFICATIONS	DIMENSIONS	ADDITIONAL SPECIFICATIONS		
160776 Monitor			Std pkg 1 Servicing: HC-CARGO 160775		Voltage: 12/24 Height: 140.5 mm Depth: 51.8 mm Display size: 7" Width: 192 mm Resolution: 480x234 pixels	Signal system: PAL/NTSC Type: LED Camera type: Colour Mount. bracket: w/ Remote control: w/o Loudspeaker: w/ Audio: Yes Mirror function: w/ Language: English	
160784 Monitor			Std pkg 1 Servicing: HC-CARGO 160783		Voltage: 12/24 Height: 140.5 mm Depth: 51.8 mm Display size: 7" Width: 192 mm Resolution: 480x234 pixels	Signal system: PAL/NTSC Type: TFT-LCD Camera type: Colour Mount. bracket: w/ Remote control: w/o Loudspeaker: w/ Audio: Yes Mirror function: w/ Language: English Alternativ no.: 160776	
160995 Monitor			Std pkg 1 Servicing: HC-CARGO 160994, 161039, 161046		Voltage: 12-24 Display size: 7" Resolution: 400x234 pixels	Signal system: PAL/NTSC Type: TFT-LCD Camera type: Colour Mount. bracket: w/ Remote control: w/ Loudspeaker: w/ Audio: Yes Mirror function: w/o Language: Chinese, German, English, French, Dutch, Italian, Japanese, Portuguese, Spanish Alternativ no.: 161034	
161007 Monitor 7" Waterproof			Std pkg 1	Side Camera: HC-CARGO 161030, 161056, 161057. Colour camera: HC-CARGO 161041, 161029, 161006, 161043. Accessories: HC-CARGO 160888, 160889, 160916.		Voltage: 12-24 Display size: 7" Resolution: 800x480 pixels	Signal system: PAL/NTSC Type: TFT-LCD Camera type: Colour Remote control: w/ Protection degree: IP 67 Language: Chinese, German, English, French, Dutch, Italian, Japanese, Portuguese, Spanish
161032 Monitor			Std pkg 1 Servicing: HC-CARGO 161048	Aerial: HC-CARGO 161036.		Voltage: 12-24 Height: 149 mm Depth: 82 mm Display size: 7" Width: 218 mm Resolution: 800x480 pixels	Type: TFT-LCD Camera type: Colour - Wireless Mount. bracket: w/ Remote control: w/o Loudspeaker: w/ Audio: Yes Mirror function: w/ Language: English Alternativ no.: 161049
161034 Monitor			Std pkg 1 Servicing: HC-CARGO 161046			Voltage: 12-24 Height: 149 mm Depth: 82 mm Display size: 7" Width: 218 mm Resolution: 800x480 pixels	Signal system: PAL/NTSC Type: TFT-LCD Camera type: Colour Mount. bracket: w/ Remote control: w/o Loudspeaker: w/ Audio: Yes Mirror function: w/ Language: Chinese, German, English, French, Dutch, Italian, Portuguese, Spanish, Danish, Russian, Polish Alternativ no.: 161047

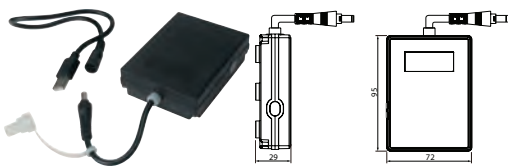
		EL. SPECIFICATIONS	DIMENSIONS	ADDITIONAL SPECIFICATIONS
161040 Monitor		Std pkg 1 Servicing: HC-CARGO 161039, 161046, 160994, 160996		
		Voltage: 12-24	Display size: 5" Resolution: 640x480 pixels	Signal system: PAL/NTSC Type: TFT-LCD Camera type: Colour Mount. bracket: w/ Remote control: w/ Loudspeaker: w/ Audio: Yes Mirror function: w/ Language: Chinese, German, English, French, Dutch, Italian, Portuguese, Spanish, Danish, Russian, Polish
161047 Monitor		Std pkg 1 Servicing: HC-CARGO 161046		
<i>Monitor Mounting, w/suction Cup: HC-CARGO 161044.</i> 		Voltage: 12-24	Height: 149 mm Depth: 82 mm Display size: 7" Width: 218 mm Resolution: 800x480 pixels	Signal system: PAL/NTSC Type: TFT-LCD Camera type: Colour Mount. bracket: w/ Remote control: w/o Loudspeaker: w/ Audio: Yes Mirror function: w/ Language: Chinese, German, English, French, Dutch, Italian, Portuguese, Spanish, Danish, Russian, Polish
161049 Monitor		Std pkg 1 Servicing: HC-CARGO 161048		
<i>Monitor Mounting, w/suction Cup: HC-CARGO 161044. Aerial: HC-CARGO 161036.</i> 		Voltage: 12-24	Height: 149 mm Depth: 82 mm Display size: 7" Width: 218 mm Resolution: 800x400 pixels	Signal system: PAL/NTSC Type: TFT-LCD Camera type: Colour - Wireless Mount. bracket: w/ Remote control: w/o Loudspeaker: w/ Audio: Yes Mirror function: w/ Language: English
161052 Monitor		Std pkg 1 Servicing: HC-CARGO 161051		
<i>Monitor Mounting, w/suction Cup: HC-CARGO 161044.</i> 		Voltage: 12-24	Height: 139 mm Depth: 68 mm Display size: 7" Width: 203 mm Resolution: 800x480 pixels	Signal system: PAL/NTSC Type: TFT-LCD Camera type: Colour Mount. bracket: w/ Remote control: w/ Loudspeaker: w/ Audio: Yes Mirror function: w/ Language: Chinese, German, English, French, Dutch, Italian, Spanish, Danish, Russian, Polish
161053 Monitor		Std pkg 1 Servicing: HC-CARGO 161051		
<i>Monitor Mounting, w/suction Cup: HC-CARGO 161044.</i> 		Voltage: 12-24	Height: 149.3 mm Depth: 84 mm Display size: 7" Width: 220 mm Resolution: 800x480 pixels	Signal system: PAL/NTSC Type: TFT-LCD Camera type: Colour Remote control: w/o Audio: No Mirror function: w/ Protection degree: IP 68 Language: English
161055 Monitor		Std pkg 1 Servicing: HC-CARGO 161054		
<i>Monitor Mounting, w/suction Cup: HC-CARGO 161044. Aerial: HC-CARGO 161036.</i> 		Voltage: 12-24	Height: 118 mm Depth: 69.5 mm Display size: 5" Width: 157 mm Resolution: 800x480 pixels	Signal system: PAL/NTSC Type: TFT-LCD Camera type: Colour - Wireless Mount. bracket: w/ Remote control: w/o Audio: No Mirror function: w/ Language: English

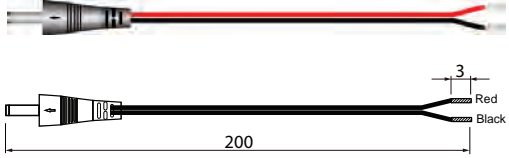
		EL. SPECIFICATIONS	DIMENSIONS	ADDITIONAL SPECIFICATIONS
161723 Monitor	Std pkg 1	Servicing: HC-CARGO 161720		
			Voltage: 12-24 Height: 122 mm Depth: 28 mm Display size: 7" Width: 185 mm Resolution: 800x480 pixels	Signal system: PAL/NTSC Type: TFT-LCD Camera type: Colour - Wireless Remote control: w/o Loudspeaker: w/ Audio: Yes Mirror function: w/ Language: English
161727 Monitor 7"	Std pkg 1	Servicing: HC-CARGO 161726		
			Voltage: 8-32 Height: 149 mm Depth: 82 mm Display size: 7" Width: 218 mm Resolution: 800x480 pixels	Signal system: PAL/NTSC Type: TFT-LCD Camera type: Colour - Wireless Mount. bracket: w/ Remote control: w/o Loudspeaker: w/ Audio: Yes Mirror function: w/ Language: English
161729 Monitor	Std pkg 1	Servicing: HC-CARGO 161728		
			Voltage: 8-32 Height: 179 mm Depth: 82 mm Display size: 9" Width: 256 mm Resolution: 800x480 pixels	Signal system: PAL/NTSC Type: TFT-LCD Camera type: Colour - Wireless Remote control: w/o Loudspeaker: w/ Audio: Yes Mirror function: w/ Language: English
161730 Monitor	Std pkg 1	Servicing: HC-CARGO 161720, 161726, 161728		
			Voltage: 8-32 Height: 149 mm Depth: 84 mm Display size: 7" Width: 220 mm Resolution: 800x480 pixels	Signal system: PAL/NTSC Type: TFT-LCD Camera type: Colour - Wireless Mount. bracket: w/ Remote control: w/o Loudspeaker: w/ Audio: w/ Mirror function: w/ Protection degree: IP 68 Language: English
ACCESSORIES				
160611 CCTV Extension Cable	Std pkg 1	Servicing: HC-CARGO 160775, 160783, 160793		
			Length: 20 m	Plug: Mini DIN 6 pin
160612 CCTV Extension Cable	Std pkg 1	Servicing: HC-CARGO 160775, 160783, 160793		
			Length: 15 m	Plug: Mini DIN 6 pin
160613 CCTV Extension Cable	Std pkg 1	Servicing: HC-CARGO 160775, 160783, 160793		
			Length: 10 m	Plug: Mini DIN 6 pin

		EL. SPECIFICATIONS	DIMENSIONS	ADDITIONAL SPECIFICATIONS
160672	CCTV Extension Cable	Std pkg 1	Servicing: HC-CARGO 160775, 160783, 160793	
			Length: 6 m	Plug: Mini DIN 6 pin
160888	CCTV Extension Cable	Std pkg 1	Servicing: HC-CARGO 160994, 160996, 161039, 161051	
			Length: 20 m	Plug: 4 pin
160889	CCTV Extension Cable	Std pkg 1	Servicing: HC-CARGO 160994, 160996, 161027	
			Length: 10 m	Plug: 4 pin
160916	Trailer Cable Kit	Std pkg 1	Servicing: HC-CARGO 160994, 160996	
			Cable from socket to camera: 2 m Cable from socket to monitor: 5 m Coil length: 3 m	Plug: 4 pin
160993	Trailer Cable Kit	Std pkg 1	Servicing: HC-CARGO 160775	
			Cable from socket to camera: 20 m Cable from socket to monitor: 5 m Coil length: 2 m	Plug: Mini DIN 6 pin
161036	Aerial	Std pkg 1	Servicing: HC-CARGO 161032, 161033, 161048, 161049, 161050, 161054, 161055, 161058	
				Colour: Black Material: Rubber
161044	Monitor Mounting, W/suction Cup	Std pkg 1	Servicing: HC-CARGO 161039, 161046, 161047, 161048, 161049, 161051, 161052, 161053, 161054, 161055	
<i>Suction.</i>				
			Length: 220 mm	Colour: Black

161722 Power bank Std pkg 1 Servicing: HC-CARGO 161048, 161054, 161720, 161726, 161728 <i>Battery lifetime 8 h.</i>				Voltage/in: 5 Milliamp: 10.000 Amp/standby: 10 Watt/cont.: 10 Watt/cont. 2: 7	Dim.: 95x72x29 mm	Type: Li-ion USB plug: w/ Protection degree: IP 66 Approval: CE
161724 Magnet Std pkg 1				Height: 6 mm Width: 43 mm		
161725 Aerial Std pkg 1 Servicing: HC-CARGO 11048, 161054, 161720, 161726, 161728				Cable length: 2500 mm		
161731 DC Connector Std pkg 1 Servicing: HC-CARGO 11048, 161054, 161720, 161726, 161728						
161732 DIN Plug Std pkg 1 Servicing: HC-CARGO 11048, 161054, 161720, 161726, 161728						
<h2 style="text-align: left;">PARKING SENSORS</h2>						
160884 Parking Sensor Std pkg 1 <i>4 sensors. Wireless.</i>				Voltage: 9-14	Dim. display: 128x27x22 mm Sensor dia.: 20 mm	
160930 Parking Sensor Std pkg 1 <i>8 sensors. Wireless.</i>				Voltage: 9-14	Dim. display: 128x27x22 mm Sensor dia.: 20 mm	Connection: Wireless Colour: Black

ACOUSTIC WARNING REVERSING ALARMS

160346 Reversing Alarm Std pkg 1

w/ "beep-beep" warning sound.

 Voltage: 12
 Watt: 10
 Decibel: 90

 Bulb type: Halogen
 Socket type: BA15S
 ADR-approved: No

160410 Reversing Alarm Std pkg 1

w/ "beep-beep" warning sound.

 Voltage: 24
 Watt: 20
 Decibel: 90

 Bulb type: Halogen
 Socket type: BA15S
 ADR-approved: No

160481 Reversing Alarm Std pkg 1

 Voltage: 12/24
 Amp: 0.25
 Decibel: 96
 Hertz: 2500

 Overvoltage: Yes
 Waterproof: Yes
 ADR-approved: No

160482 Reversing Alarm Std pkg 1

Night attenuation, excluding when fog lights are on. RED LEAD- To reverse lamp, BLACK LEAD- To earth, ORANGE LEAD- To side lamp (night silent mode), GREEN LEAD- To fog lamp (night silent override).

 Voltage: 12/24
 Amp: 0.25
 Decibel: 100
 Hertz: 980

 Overvoltage: Yes
 Waterproof: Yes
 ADR-approved: Yes

160689 Reversing Alarm Std pkg 1

 Voltage: 12/80
 Milliamp: 30
 Decibel: 85
 Hertz: 3200

 Type: Buzzer
 Waterproof: Yes
 ADR-approved: No

161125 Reversing Alarm Std pkg 1

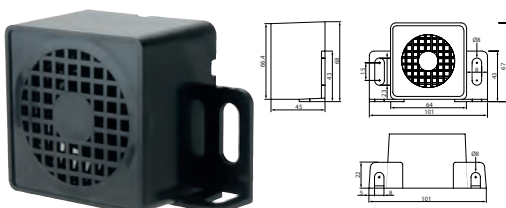
Soft tone alarm ideal for built up areas where noise pollution may be an issue.

 Voltage: 12/24
 Milliamp: 0.5
 Decibel: 88

 Overvoltage: Yes
 Waterproof: Yes

161126 Reversing Alarm Std pkg 1

Soft tone alarm ideal for built up areas where noise pollution may be an issue.



Voltage: 12/24
Miliamp: 0.5
Decibel: 92

Overvoltage: Yes
Waterproof: Yes

BUZZERS

160533 Warning Buzzer Std pkg 1



Voltage: 24
Miliamp: 30
Decibel: 85
Hertz: 400±100

160534 Warning Buzzer Std pkg 1



Voltage: 12
Miliamp: 30
Decibel: 85
Hertz: 400±100

HORNS

ELECTRICAL

160036 Twin Fanfare Horn Std pkg 1

Red w/ chromium grill.



Voltage: 12
Amp: 9
Decibel: 110
Hertz: 405-500

Relay: w/
Marine: No
E-approval: Yes

160393 Horn Std pkg 1

2 terminals. w/ bracket.



Voltage: 36-48
Amp: 1
Decibel: 112
Hertz: 420

OD: 100 mm

Type: Single tone
Material: Steel
Marine: No
E-approval: Yes

160414 Horn Std pkg 1

Model EM2.



Voltage: 24
Amp: 4
Decibel: 118
Hertz: 370

Length: 400 mm

Type: Single tone
Material: Chromed brass
Relay: w/o
Marine: Yes

160415 Horn		Std pkg 1			
Model EM2.  					
Voltage: 12 Amp: 5 Decibel: 118 Hertz: 370		Length: 400 mm		Type: Single tone Material: Chromed brass Relay: w/o Marine: Yes	
160658 Horn		Std pkg 1	Servicing: VW - Visit our web catalogue for further information		
w/ K- Jetronic connection. w/ bracket.					
 		Voltage: 12 Amp: <1 Hertz: 335		OD: 100 mm Type: Single tone Material: Steel Marine: No E-approval: Yes	
160712 Horn		Std pkg 1	Servicing: VW - Visit our web catalogue for further information		
2 poles.					
 		Voltage: 12 Hertz: 500-420		OD: 82 mm Length: 117 mm Type: Dual tone Relay: w/o Marine: No E-approval: Yes	
160746 Horn		Std pkg 1	Servicing: Scooters and motor cycles - Visit our web catalogue for further information		
2 terminals. w/ bracket.					
 		Voltage: 12 Amp: 1-1.4 Decibel: 109 Hertz: 410-550		OD: 70 mm Type: Single tone Material: Steel Marine: No E-approval: Yes	
160827 Horn		Std pkg 1	Servicing: Scooters and motor cycles - Visit our web catalogue for further information		
 		Voltage: 24 Amp: 5 Hertz: 500-420		OD: 80 mm Length: 117 mm Type: Dual tone Relay: w/ Marine: No E-approval: Yes	
160986 Horn		Std pkg 1	Servicing: Scooters and motor cycles - Visit our web catalogue for further information		
2 terminals. w/ bracket.					
 		Voltage: 12 Amp: 3.5 Decibel: 112 Hertz: 420		OD: 90 mm Type: Single tone Material: Steel Marine: No E-approval: Yes	
160987 Horn		Std pkg 1	Servicing: Scooters and motor cycles - Visit our web catalogue for further information		
2 terminals. w/ bracket.					
 		Voltage: 24 Amp: 2.5 Decibel: 112 Hertz: 420		OD: 90 mm Type: Single tone Material: Steel Marine: No E-approval: Yes	

		EL. SPECIFICATIONS	DIMENSIONS	ADDITIONAL SPECIFICATIONS
160988 Horn Std pkg 1				
2 terminals. w/ bracket.				
		Voltage: 12 Amp: 3.5 Decibel: 112 Hertz: 335	OD: 90 mm	Type: Single tone Material: Steel Marine: No E-approval: Yes
160989 Horn Std pkg 1				
2 terminals. w/ bracket.				
		Voltage: 24 Amp: 2.5 Decibel: 112 Hertz: 335	OD: 90 mm	Type: Single tone Material: Steel Marine: No E-approval: Yes
AIR HORNS				
160002 Compressor Horn Std pkg 1				
w/ parts. Y-Connector: HC-CARGO 160042.				
		Voltage: 12 Amp: 16 Decibel: 117 Hertz: 630-795		Type: Dual tone Material: Shockproof plastic Relay: w/ E-approval: Yes
160038 Pneumatic Horn Std pkg 1				
Operating pressure 500-1200 kPa. For trucks equipped w/ on-board air. Compressor: HC-CARGO 160333, 160334.				
		Decibel: 118 Hertz: 330/370	OD: 80 mm Length: 390 mm	Type: Dual tone Material: Chromed Metal E-approval: Yes
160048 Marine Horn Std pkg 1				
To be powered by electric air compressor: HC-CARGO 160213. Audibility at least 1600 mtr. over open water.				
		Decibel: 120 Hertz: 380	Length: 385 mm Capacity: 72 l/min	Material: Stainless steel Marine: Yes
160355 Pneumatic Horn Std pkg 1 Servicing: Trucks - Visit our web catalogue for further information				
Operating pressure 30-1200 kPa. Equipped w/ on-board air.				
		Decibel: 118 Hertz: 210	OD: 160 mm Length: 600 mm	Type: Single tone Material: Chromed Metal E-approval: Yes
160356 Pneumatic Horn Std pkg 1 Servicing: Trucks - Visit our web catalogue for further information				
Operating pressure 30-1200 kPa. Equipped w/ on-board air.				
		Decibel: 118 Hertz: 190	OD: 160 mm Length: 680 mm	Type: Single tone Material: Chromed Metal

EL. SPECIFICATIONS		DIMENSIONS	ADDITIONAL SPECIFICATIONS
160508 Compressor Horn Std pkg 1 <i>Y-Connector: HC-CARGO 160042.</i>			
	Voltage: 24 Amp: 8 Decibel: 118 Hertz: 692-756		Type: Dual tone Material: Shockproof plastic Relay: w/ E-approval: Yes
160632 Marine Air Horn Std pkg 1			
	Voltage: 24 Decibel: 117 Hertz: 228	Length: 500 mm	Material: Stainless steel Marine: Yes
160744 Compressor Horn Std pkg 1 <i>Servicing: Boats until 12 m - Visit our web catalogue for further information</i> <i>Electro pneumatic horn w/ integrated compressor.</i>			
	Voltage: 24 Decibel: 120 Hertz: 300	Length: 120x190x120 mm	Type: Single tone Material: ASA plastic Relay: w/ Marine: Yes
160756 Marine Air Horn Std pkg 1 <i>Approvals: Rina ELE/35398/2. Lloyds register MSA 9800031.</i>			
	Voltage: 24 Decibel: 123 Hertz: 630	OD: 200 mm Length: 460 mm	Type: Single tone Material: Enameled Brass Marine: Yes
SPARE PARTS			
160039 Electric Valve Std pkg 1 <i>For Compressor horn.</i>			
	Voltage: 24		
160042 Y-Connector Std pkg 10 <i>Servicing: HC-CARGO 160002, 160508</i>			
160213 Compressor Std pkg 1 <i>Servicing: HC-CARGO 160048</i>			
	Voltage: 24	OD: 90 mm Length: 165 mm Pressure: 2 bar	Material: Aluminium Relay: w/ Marine: Yes

160333 Compressor Std pkg 1 Servicing: HC-CARGO 160038 <i>Approved for boats until 12 mtr.</i>					
 		Voltage: 12		OD: 70 mm Length: 112 mm Pressure: 1.5 bar	
				Type: 1, 2 and 3 tones Material: Aluminium Relay: w/ Marine: Yes	
160334 Compressor Std pkg 1 Servicing: HC-CARGO 160038					
 		Voltage: 24		OD: 70 mm Length: 112 mm Pressure: 1.5 bar	
				Type: 1, 2 and 3 tones Material: Aluminium Relay: w/ Marine: Yes	
190097 PA Hose 8 mm Std pkg 50					
				ID: 8 mm OD: 11.6 mm Length: 50 m Temp.: -15 - +60 °C	

POWER MANAGEMENT COMPONENTS

VOLTAGE CONVERTERS

160899 Adaptor Std pkg 1 <i>Max. output 220 W. 7-13 pole.</i>					
		Voltage/in: 24 Voltage/out: 12 Watt/out: 6x70		Type: Switch mode	
160900 Trailer Light Converter Adapter Std pkg 1 <i>Max. output 220 W. 7-7 pole.</i>					
		Voltage/in: 24 Voltage/out: 12 Watt/out: 6x70		Type: Switch mode	
160901 Trailer Light Converter Std pkg 1 <i>Output: 2x21 W + 4x60 W. To be used when HC-CARGO 160899 and 160900 are not suited.</i>					
		Voltage/in: 24 Voltage/out: 12 Amp/idling: 0			

NON INSULATED

NON INSULATED		EL. SPECIFICATIONS	DIMENSIONS	ADDITIONAL SPECIFICATIONS
160306	Voltage Converter	Std pkg 1		
		Voltage/in: 24 Voltage/out: 12 Amp/5 min.: 18 Amp/cont.: 12	Dim.: 127X87X50 mm	Type: Switch mode/uninsulated Protection against over current: Yes Protection against over heating: Yes Protection against overvoltage: Yes Protection against reverse connection: Yes Protection against transients: Yes Approval: CE
160387	Voltage Converter	Std pkg 1		
		Voltage/in: 24 Voltage/out: 12 Amp/5 min.: 6 Amp/cont.: 3	Dim.: 67x87x50 mm	Type: Switch mode/uninsulated Protection against over current: Yes Protection against over heating: Yes Protection against overvoltage: Yes Protection against reverse connection: Yes Protection against transients: Yes Approval: CE
160388	Voltage Converter	Std pkg 1		
		Voltage/in: 24 Voltage/out: 12 Amp/5 min.: 10 Amp/cont.: 6	Dim.: 89x87x50 mm	Type: Switch mode/uninsulated Protection against over current: Yes Protection against over heating: Yes Protection against overvoltage: Yes Protection against reverse connection: Yes Protection against transients: Yes Approval: CE
160389	Voltage Converter	Std pkg 1		
		Voltage/in: 24 Voltage/out: 12 Amp/5 min.: 30 Amp/cont.: 24	Dim.: 167x87x50 mm	Type: Switch mode/uninsulated Protection against over current: Yes Protection against over heating: Yes Protection against overvoltage: Yes Protection against reverse connection: Yes Protection against transients: Yes Approval: CE
160640	Converter	Std pkg 1		
		Voltage/in: 24 Voltage/out: 12 Amp/5 min.: 60 Amp/cont.: 50	Dim.: 283x125x74 mm	Type: Switch mode/uninsulated Protection against over current: Yes Protection against over heating: Yes Protection against overvoltage: Yes Protection against reverse connection: Yes Protection against transients: Yes Approval: CE
160642	Converter	Std pkg 1		
		Voltage/in: 12 Voltage/out: 24 Amp/cont.: 3 Watt/out: 72	Dim.: 89x87x50 mm	Type: Switch mode/uninsulated Protection against over current: Yes Protection against over heating: Yes Protection against overvoltage: Yes Protection against reverse connection: Yes Protection against transients: Yes Approval: CE
160646	Converter	Std pkg 1		
		Voltage/in: 12 Voltage/out: 24 Amp/cont.: 10 Watt/out: 240	Dim.: 217x87x50 mm	Type: Switch mode/uninsulated Protection against over current: Yes Protection against over heating: Yes Protection against overvoltage: Yes Protection against reverse connection: Yes Protection against transients: Yes Approval: CE

		EL. SPECIFICATIONS	DIMENSIONS	ADDITIONAL SPECIFICATIONS
161072	Voltage Converter	Std pkg 1		
		Voltage/in: 12 Voltage/out: 24 Amp/cont.: 16 Watt/out: 400	Dim.: 233x125x74 mm	Type: Switch mode/uninsulated Protection against over current: Yes Protection against over heating: Yes Protection against overvoltage: Yes Protection against reverse connection: Yes Protection against transients: Yes Approval: CE
161073	Voltage Converter	Std pkg 1		
		Voltage/in: 12 Voltage/out: 24 Amp/cont.: 25 Watt/out: 600	Dim.: 283x125x74 mm	Type: Switch mode/uninsulated Protection against over current: Yes Protection against over heating: Yes Protection against overvoltage: Yes Protection against reverse connection: Yes Protection against transients: Yes Approval: CE
161080	Voltage Converter	Std pkg 1		
		Voltage/in: 24 Voltage/out: 12 Amp/5 min.: 22 Amp/cont.: 18	Dim.: 167x87x50 mm	Type: Switch mode/uninsulated Protection against over current: Yes Protection against over heating: Yes Protection against overvoltage: Yes Protection against reverse connection: Yes Protection against transients: Yes Approval: CE
INSULATED				
160390	Voltage Converter	Std pkg 1		
<i>The converter is supplied w/ an unique clip mounting bracket. The converter is intended for use w/ the same equipment as HC-CARGO 160387, but for systems where full isolation is required e.g. marine electrical systems and vehicles for petroche. Instruction included.</i>				
		Voltage/in: 24 Voltage/out: 12 Amp/5 min.: 6 Amp/cont.: 3	Dim.: 89x87x50 mm	Type: Switch mode/isolated Protection against over current: Yes Protection against over heating: Yes Protection against overvoltage: Yes Protection against reverse connection: Yes Protection against transients: Yes Approval: CE
160391	Voltage Converter	Std pkg 1		
<i>The converter is supplied w/ an unique clip mounting bracket. The converter is intended for use w/ the same equipment as HC-CARGO 160388, but for systems where full isolation is required e.g. marine electrical systems and vehicles for petroche. Instruction included.</i>				
		Voltage/in: 24 Voltage/out: 12 Amp/5 min.: 10 Amp/cont.: 6	Dim.: 127x87x50 mm	Type: Switch mode/isolated Protection against over current: Yes Protection against over heating: Yes Protection against overvoltage: Yes Protection against reverse connection: Yes Protection against transients: Yes Approval: CE
160392	Voltage Converter	Std pkg 1		
<i>The converter is supplied w/ an unique clip mounting bracket. The converter is intended for use w/ the same equipment as HC-CARGO 160306, but for systems where full isolation is required e.g. marine electrical systems and vehicles for petroche. Instruction included.</i>				
		Voltage/in: 24 Voltage/out: 12 Amp/5 min.: 18 Amp/cont.: 12	Dim.: 167x87x50 mm	Type: Switch mode/isolated Protection against over current: Yes Protection against over heating: Yes Protection against overvoltage: Yes Protection against reverse connection: Yes Protection against transients: Yes Approval: CE
160644	Converter	Std pkg 1		
		Voltage/in: 12 Voltage/out: 24 Amp/cont.: 7 Watt/out: 168	Dim.: 167x87x50 mm	Type: Switch mode/isolated Protection against over current: Yes Protection against over heating: Yes Protection against overvoltage: Yes Protection against reverse connection: Yes Protection against transients: Yes Approval: CE

		EL. SPECIFICATIONS	DIMENSIONS	ADDITIONAL SPECIFICATIONS
161074	Voltage Converter	Std pkg 1		
		Voltage/in: 24 Voltage/out: 24 Amp/cont.: 3 Watt/out: 72	Dim.: 127X87X50 mm	Type: Switch mode/isolated Protection against over current: Yes Protection against over heating: Yes Protection against overvoltage: Yes Protection against reverse connection: Yes Protection against transients: Yes Approval: CE
161075	Voltage Converter	Std pkg 1		
		Voltage/in: 24 Voltage/out: 24 Amp/cont.: 4.5 Watt/out: 108	Dim.: 167x87x50 mm	Type: Switch mode/isolated Protection against over current: Yes Protection against over heating: Yes Protection against overvoltage: Yes Protection against reverse connection: Yes Protection against transients: Yes Approval: CE
161076	Voltage Converter	Std pkg 1		
		Voltage/in: 24 Voltage/out: 24 Amp/cont.: 7 Watt/out: 168	Dim.: 217x87x50 mm	Type: Switch mode/isolated Protection against over current: Yes Protection against over heating: Yes Protection against overvoltage: Yes Protection against reverse connection: Yes Protection against transients: Yes Approval: CE
161077	Voltage Converter	Std pkg 1		
		Voltage/in: 24 Voltage/out: 24 Amp/cont.: 10 Watt/out: 240	Dim.: 217x87x62 mm	Type: Switch mode/isolated Protection against over current: Yes Protection against over heating: Yes Protection against overvoltage: Yes Protection against reverse connection: Yes Protection against transients: Yes Approval: CE
161079	Voltage Converter	Std pkg 1		
		Voltage/in: 24 Voltage/out: 12 Amp/5 min.: 22 Amp/cont.: 18	Dim.: 217x87x50 mm	Type: Switch mode/isolated Protection against over current: Yes Protection against over heating: Yes Protection against overvoltage: Yes Protection against reverse connection: Yes Protection against transients: Yes Approval: CE
161081	Voltage Converter	Std pkg 1		
		Voltage/in: 24 Voltage/out: 12 Amp/cont.: 24	Dim.: 217x87x50 mm	Type: Switch mode/isolated Protection against over current: Yes Protection against over heating: Yes Protection against overvoltage: Yes Protection against reverse connection: Yes Protection against transients: Yes Approval: CE
MULTI POWER				
160579	Voltage Converter	Std pkg 1		
		Voltage/in: 36-90 Voltage/out: 12 Amp/cont.: 6 Watt/out: 75	Dim.: 134x94x18 mm	Protection degree: IP 68

	EL. SPECIFICATIONS	DIMENSIONS	ADDITIONAL SPECIFICATIONS
160580 Voltage Converter Std pkg 1 	Voltage/in: 36-90 Voltage/out: 12 Amp/cont.: 15	Dim.: 134x94x48 mm	Protection degree: IP 68
<h2>RELAY BOXES</h2>			
160167 Relay Box Std pkg 1 Servicing: For 12 V trailer pulled by a 24 V vehicle - Visit our web catalogue for further information <i>Switches the voltage from 24 V to 12 V by 5 relays. Run at 24 V and leading 12 V from one of the batteries or converter to the lamps of the trailer. For continuous use it has to be connected via a converter. For internal mounting.</i>	Voltage: 12/24 Amp: 10 Watt: 250	Dim.: 100x100x58 mm	No./poles: 7 Relay switch: Yes
160502 Trailer Connecting Unit Std pkg 1 Servicing: For 12 V trailer pulled by a 24 V vehicle - Visit our web catalogue for further information <i>Mounted w/o use of converter.</i>	Voltage: 24/12 	Dim.: 110x103x43 mm	C2 control lamp: w/ No./poles: 7 Relay switch: No Transistor switch: Yes Waterproof: Yes Protection degree: IP 65
160797 Relay Box Std pkg 1 <i>To reduce voltage drop, if you use vehicles w/ trailer. Fitted w/ 5x12 V relays the 12 V function will not be affected.</i>	Voltage: 12-12 Amp: 5x8 Watt: 5x250 	Dim.: 100x100x58 mm	
<h2>VOLTAGE INVERTERS</h2>			
160541 Voltage Inverter Std pkg 1 	Voltage/in: 12 Voltage/out: 230 Voltage/Alarm: 10.5±0.5 Voltage/Shut down: 10±0.5 Amp/max/cont.: <20 Amp/standby: <0.3 Watt/cont.: 150 Watt/max.: 450	Dim.: 165x91x58 mm Temp.: 60±5 °C Regulation: ±10 Efficiency: Over 90 %	Type: Modified sine Over heating: Yes Overloading: Yes Short circuit: Yes Approval: CE Alternativ no.: 161078
160542 Voltage Inverter Std pkg 1 	Voltage/in: 24 Voltage/out: 230 Voltage/Alarm: 21±1 Voltage/Shut down: 20±1 Amp/max/cont.: <10 Amp/standby: <0.3 Watt/cont.: 150 Watt/max.: 450	Dim.: 165x91x58 mm Temp.: 60±5 °C Regulation: ±10 Efficiency: Over 90 %	Type: Modified sine Over heating: Yes Overloading: Yes Short circuit: Yes Approval: CE Alternativ no.: 161082

160543 Voltage Inverter Std pkg 1

Voltage/in: 10-15
 Voltage/out: 230
 Voltage/Alarm: 10.5±0.5
 Voltage/Shut down: 10±0.5
 Amp/max/cont.: <35
 Amp/standby: <0.3
 Watt/cont.: 300
 Watt/max.: 1000

Dim.: 190x91x58 mm
 Temp.: 60±5 °C
 Regulation: ±10
Efficiency: Over 90 %

Type: Modified sine
 Over heating: Yes
 Overloading: Yes
 Short circuit: Yes
 Approval: CE
 Alternativ no.: 161085

160544 Voltage Inverter Std pkg 1

Voltage/in: 24
 Voltage/out: 230
 Voltage/Alarm: 21±1
 Voltage/Shut down: 20±1
 Amp/max/cont.: <20
 Amp/standby: <0.3
 Watt/cont.: 300
 Watt/max.: 1000

Dim.: 190x91x58 mm
 Temp.: 60±5 °C
 Regulation: ±10

Type: Modified sine
 Over heating: Yes
 Overloading: Yes
 Short circuit: Yes
 Approval: CE
 Alternativ no.: 161086

160545 Voltage Inverter Std pkg 1

Voltage/in: 10-15
 Voltage/out: 230
 Voltage/Alarm: 10.5±0.5
 Voltage/Shut down: 10±0.5
 Amp/standby: <0.3
 Watt/cont.: 600
 Watt/max.: 1500

Dim.: 242x91x58 mm
 Temp.: 60±5 °C
 Regulation: ±10

Type: Modified sine
 Over heating: Yes
 Overloading: Yes
 Short circuit: Yes
 Approval: CE
 Alternativ no.: 161089

160546 Voltage Inverter Std pkg 1

Voltage/in: 24
 Voltage/out: 230
 Voltage/Alarm: 21±1
 Voltage/Shut down: 20±1
 Amp/standby: <0.3
 Watt/cont.: 600
 Watt/max.: 1500

Dim.: 242x91x58 mm
 Temp.: 60±5 °C
 Regulation: ±10

Type: Modified sine
 Over heating: Yes
 Overloading: Yes
 Short circuit: Yes
 Approval: CE
 Alternativ no.: 161090

160569 Voltage Inverter Std pkg 1

Remote Control: HC-CARGO 161045.



Voltage/in: 12
 Voltage/out: 230
 Voltage/Alarm: 10.5±0.5
 Voltage/Shut down: 10±0.5
 Amp/standby: <2
 Watt/cont.: 1500
 Watt/max.: 3500

Dim.: 395x240x90 mm
 Temp.: 60±5 °C

Type: Modified sine
 Cooling fan: Yes
 Over heating: Yes
 Overloading: Yes
 Short circuit: Yes
 Approval: CE
 Alternativ no.: 161097

160581 Voltage Inverter Std pkg 1

Remote Control: HC-CARGO 161045.



Voltage/in: 24
 Voltage/out: 230
 Voltage/Alarm: 21±1
 Voltage/Shut down: 20±1
 Amp/standby: <1
 Watt/cont.: 1500
 Watt/max.: 3500

Dim.: 395x240x90 mm
 Temp.: 60±5 °C







Type: Modified sine
 Over heating: Yes
 Overloading: Yes
 Short circuit: Yes
 Approval: CE
 Alternativ no.: 161098

160660 Voltage Inverter Std pkg 1

Voltage/in: 10-15
 Voltage/out: 230
 Voltage/Alarm: 10.5±0.5
 Voltage/Shut down: 10±0.5
 Amp/standby: <0.8
 Watt/cont.: 1000
 Watt/max.: 2500

Dim.: 310x205x75 mm
 Temp.: 60±5 °C
 Regulation: ±10

Type: Modified sine
 Over heating: Yes
 Overloading: Yes
 Short circuit: Yes
 Approval: CE
 Alternativ no.: 161093

	EL. SPECIFICATIONS	DIMENSIONS	ADDITIONAL SPECIFICATIONS
160676 Voltage Inverter Std pkg 1 	Voltage/in: 24 Voltage/out: 230 Voltage/Alarm: 21±1 Voltage/Shut down: 20±1 Amp/standby: <0.8 Watt/cont.: 1000 Watt/max.: 2500	Dim.: 310x205x75 mm Temp.: 60±5 °C Regulation: ±10	Type: Modified sine Over heating: Yes Overloading: Yes Short circuit: Yes Approval: CE Alternativ no.: 161094
160991 Voltage Inverter AC-DC Std pkg 1 	Voltage/in: 230 Voltage/out: 12V DC Amp/max/cont.: 25	Dim.: 226.5x115x49.7 mm Temp.: 85±5 °C	Connection: Connection Type: AC-DC Over heating: Yes Overloading: Yes Short circuit: Yes Approval: CE
161078 Voltage Inverter Std pkg 1 	Voltage/in: 12 Voltage/out: 220-240 Voltage/Alarm: 11±0.5 Voltage/Shut down: 10±0.5 Amp/max/cont.: 15 Amp/standby: <0.28 Watt/cont.: 150 Watt/max.: 450	Dim.: 120x73x73 mm Temp.: 60±5 °C Efficiency: 90 %	Type: Modified sine Over heating: Yes Overloading: Yes Short circuit: Yes Approval: CE Alternativ no.: 160541
161082 Voltage Inverter Std pkg 1 	Voltage/in: 24 Voltage/out: 220-240 Voltage/Alarm: 22±1 Voltage/Shut down: 20±1 Amp/max/cont.: 8 Amp/standby: <0.18 Watt/cont.: 150 Watt/max.: 450	Dim.: 120x73x73 mm Temp.: 60±5 °C Efficiency: 90 %	Type: Modified sine Over heating: Yes Overloading: Yes Short circuit: Yes Approval: CE Alternativ no.: 160542
161083 Voltage Inverter UK <i>UK version.</i> Std pkg 1 	Voltage/in: 12 Voltage/out: 220-240 Voltage/Alarm: 11±0.5 Voltage/Shut down: 10±0.5 Amp/max/cont.: 15 Amp/standby: <0.28 Watt/cont.: 150 Watt/max.: 450	Dim.: 120x73x73 mm Temp.: 60±5 °C Efficiency: 90 %	Type: Modified sine Over heating: Yes Overloading: Yes Short circuit: Yes Approval: CE
161084 Voltage Inverter - UK <i>UK version.</i> Std pkg 1 	Voltage/in: 24 Voltage/out: 220-240 Voltage/Alarm: 22±1 Voltage/Shut down: 20±1 Amp/max/cont.: 8 Amp/standby: <0.18 Watt/cont.: 150 Watt/max.: 450	Dim.: 120x73x73 mm Temp.: 60±5 °C Efficiency: 90 %	Type: Modified sine Over heating: Yes Overloading: Yes Short circuit: Yes Approval: CE
161085 Voltage Inverter Std pkg 1 	Voltage/in: 12 Voltage/out: 220-240 Voltage/Alarm: 10.5±0.5 Voltage/Shut down: 10±0.5 Amp/max/cont.: 30 Amp/standby: <0.5 Watt/cont.: 300 Watt/max.: 900	Dim.: 155x73x73 mm Temp.: 60±5 °C Efficiency: 90 %	Type: Modified sine Over heating: Yes Overloading: Yes Short circuit: Yes Approval: CE Alternativ no.: 160543

161086 Voltage Inverter Std pkg 1

Voltage/in: 24
 Voltage/out: 220-240
 Voltage/Alarm: 21±1
 Voltage/Shut down: 20±1
 Amp/max/cont.: 15
 Amp/standby: <0.5
 Watt/cont.: 300
 Watt/max.: 900

Dim.: 155x73x73 mm
 Temp.: 60±5 °C
 Efficiency: 90 %

Type: Modified sine
 Over heating: Yes
 Overloading: Yes
 Short circuit: Yes
 Approval: CE
 Alternativ no.: 160544

161087 Voltage Inverter UK Std pkg 1

UK version.



Voltage/in: 12
 Voltage/out: 220-240
 Voltage/Alarm: 10.5±0.5
 Voltage/Shut down: 10±0.5
 Amp/max/cont.: 30
 Amp/standby: <0.5
 Watt/cont.: 300
 Watt/max.: 900

Dim.: 155x73x73 mm
 Temp.: 60±5 °C
 Efficiency: 90 %

Type: Modified sine
 Over heating: Yes
 Overloading: Yes
 Short circuit: Yes
 Approval: CE

161088 Voltage Inverter UK Std pkg 1

UK version.



Voltage/in: 24
 Voltage/out: 220-240
 Voltage/Alarm: 21±1
 Voltage/Shut down: 20±1
 Amp/max/cont.: 15
 Amp/standby: <0.5
 Watt/cont.: 300
 Watt/max.: 900

Dim.: 155x73x73 mm
 Temp.: 60±5 °C
 Efficiency: 90 %

Type: Modified sine
 Over heating: Yes
 Overloading: Yes
 Short circuit: Yes
 Approval: CE

161089 Voltage Inverter Std pkg 1

Voltage/in: 12
 Voltage/out: 220-240
 Voltage/Alarm: 10.5±0.5
 Voltage/Shut down: 10±0.5
 Amp/max/cont.: 60
 Amp/standby: <0.6
 Watt/cont.: 600
 Watt/max.: 1500

Dim.: 190x113x62 mm
 Temp.: 60±5 °C
 Efficiency: 85-90 %

Type: Modified sine
 Over heating: Yes
 Overloading: Yes
 Short circuit: Yes
 Approval: CE
 Alternativ no.: 160545

161090 Voltage Inverter Std pkg 1

Voltage/in: 24
 Voltage/out: 220-240
 Voltage/Alarm: 21±1
 Voltage/Shut down: 20±1
 Amp/max/cont.: 30
 Amp/standby: <0.4
 Watt/cont.: 600
 Watt/max.: 1500

Dim.: 190x113x62 mm
 Temp.: 60±5 °C
 Efficiency: 85-90 %

Type: Modified sine
 Over heating: Yes
 Overloading: Yes
 Short circuit: Yes
 Approval: CE
 Alternativ no.: 160546

161091 Voltage Inverter UK Std pkg 1

UK version.



Voltage/in: 12
 Voltage/out: 220-240
 Voltage/Alarm: 10.5±0.5
 Voltage/Shut down: 10±0.5
 Amp/max/cont.: 60
 Amp/standby: <0.6
 Watt/cont.: 600
 Watt/max.: 1500

Dim.: 190x113x62 mm
 Temp.: 60±5 °C
 Efficiency: 85-90 %

Type: Modified sine
 Over heating: Yes
 Overloading: Yes
 Short circuit: Yes
 Approval: CE
 Alternativ no.: 161704

161092 Voltage Inverter UK Std pkg 1







UK version.



Voltage/in: 24
 Voltage/out: 220-240
 Voltage/Alarm: 21±1
 Voltage/Shut down: 20±1
 Amp/max/cont.: 30
 Amp/standby: <0.4
 Watt/cont.: 600
 Watt/max.: 1500

Dim.: 190x113x62 mm
 Temp.: 60±5 °C
 Efficiency: 85-90 %

Type: Modified sine
 Over heating: Yes
 Overloading: Yes
 Short circuit: Yes
 Approval: CE

	EL. SPECIFICATIONS	DIMENSIONS	ADDITIONAL SPECIFICATIONS
161093 Voltage Inverter Std pkg 1 <i>Remote control: HC-CARGO 161713.</i>		Voltage/in: 12 Voltage/out: 220-240 Voltage/Alarm: 10.5±0.5 Voltage/Shut down: 10±0.5 Amp/max/cont.: 100 Amp/standby: <0.6 Watt/cont.: 1000 Watt/max.: 2400	Dim.: 340x135x79 mm Temp.: 60±5 °C Efficiency: 85-90 % Type: Modified sine Over heating: Yes Overloading: Yes Short circuit: Yes Approval: CE Alternativ no.: 160660
161094 Voltage Inverter Std pkg 1 <i>Remote control: HC-CARGO 161713.</i>		Voltage/in: 24 Voltage/out: 220-240 Voltage/Alarm: 21±1 Voltage/Shut down: 20±1 Amp/max/cont.: 50 Amp/standby: <0.5 Watt/cont.: 1000 Watt/max.: 2400	Dim.: 340x135x79 mm Temp.: 60±5 °C Efficiency: 85-90 % Type: Modified sine Over heating: Yes Overloading: Yes Short circuit: Yes Approval: CE Alternativ no.: 160676
161095 Voltage Inverter UK Std pkg 1 <i>UK version. Remote control: HC-CARGO 161713.</i>		Voltage/in: 12 Voltage/out: 220-240 Voltage/Alarm: 10.5±0.5 Voltage/Shut down: 10±0.5 Amp/max/cont.: 100 Amp/standby: <0.6 Watt/cont.: 1000 Watt/max.: 2400	Dim.: 340x135x79 mm Temp.: 60±5 °C Efficiency: 85-90 % Type: Modified sine Over heating: Yes Overloading: Yes Short circuit: Yes Approval: CE Alternativ no.: 161707
161096 Voltage Inverter UK Std pkg 1 <i>UK version. Remote control: HC-CARGO 161713.</i>		Voltage/in: 24 Voltage/out: 220-240 Voltage/Alarm: 21±1 Voltage/Shut down: 20±1 Amp/max/cont.: 50 Amp/standby: <0.5 Watt/cont.: 1000 Watt/max.: 2400	Dim.: 340x135x79 mm Temp.: 60±5 °C Efficiency: 85-90 % Type: Modified sine Over heating: Yes Overloading: Yes Short circuit: Yes Approval: CE Alternativ no.: 160676UK
161097 Voltage Inverter Std pkg 1 <i>Remote control: HC-CARGO 161713.</i>		Voltage/in: 12 Voltage/out: 220-240 Voltage/Alarm: 10.5±0.5 Voltage/Shut down: 10±0.5 Amp/max/cont.: 150 Amp/standby: <0.7 Watt/cont.: 1500 Watt/max.: 3000	Dim.: 400x135x79 mm Temp.: 60±5 °C Efficiency: 85-90 % Type: Modified sine Over heating: Yes Overloading: Yes Short circuit: Yes Approval: CE Alternativ no.: 160569
161098 Voltage Inverter Std pkg 1 <i>Remote control: HC-CARGO 161713.</i>		Voltage/in: 24 Voltage/out: 220-240 Voltage/Alarm: 21±1 Voltage/Shut down: 20±1 Amp/max/cont.: 75 Amp/standby: <0.6 Watt/cont.: 1500 Watt/max.: 3000	Dim.: 400x135x79 mm Temp.: 60±5 °C Efficiency: 85-90 % Type: Modified sine Over heating: Yes Overloading: Yes Short circuit: Yes Approval: CE Alternativ no.: 160581
161099 Voltage Inverter UK Version Std pkg 1 <i>UK version. Remote control: HC-CARGO 161713.</i>		Voltage/in: 12 Voltage/out: 220-240 Voltage/Alarm: 10.5±0.5 Voltage/Shut down: 10±0.5 Amp/max/cont.: 150 Amp/standby: <0.7 Watt/cont.: 1500 Watt/max.: 3000	Dim.: 400x135x79 mm Temp.: 60±5 °C Efficiency: 85-90 % Type: Modified sine Over heating: Yes Overloading: Yes Short circuit: Yes Approval: CE Alternativ no.: 161705

161100 Voltage Inverter UK Version Std pkg 1

UK version. Remote control: HC-CARGO 161713.



Voltage/in: 24
 Voltage/out: 220-240
 Voltage/Alarm: 21±1
 Voltage/Shut down: 20±1
 Amp/max/cont.: 75
 Amp/standby: <0.6
 Watt/cont.: 1500
 Watt/max.: 3000

Dim.: 400x135x79 mm
 Temp.: 60±5 °C
 Efficiency: 85-90 %

Type: Modified sine
 Over heating: Yes
 Overloading: Yes
 Short circuit: Yes
 Approval: CE
 Alternativ no.: 161706

161101 Voltage Inverter Std pkg 1

Remote control: HC-CARGO 161713.



Voltage/in: 12
 Voltage/out: 220-240
 Voltage/Alarm: 10.5±0.5
 Voltage/Shut down: 10±0.5
 Amp/max/cont.: 70
 Amp/standby: <0.9
 Watt/cont.: 700
 Watt/max.: 1400

Dim.: 340x135x79 mm
 Temp.: 60±5 °C
 Efficiency: >85 %

Type: Sinus
 Over heating: Yes
 Overloading: Yes
 Short circuit: Yes
 Approval: CE

161102 Voltage Inverter Std pkg 1

Remote control: HC-CARGO 161713.



Voltage/in: 24
 Voltage/out: 220-240
 Voltage/Alarm: 21±1
 Voltage/Shut down: 20±1
 Amp/max/cont.: 35
 Amp/standby: <0.6
 Watt/cont.: 700
 Watt/max.: 1400

Dim.: 340x135x79 mm
 Temp.: 60±5 °C
 Efficiency: >85 %

Type: Sinus
 Over heating: Yes
 Overloading: Yes
 Short circuit: Yes
 Approval: CE

161103 Voltage Inverter UK Std pkg 1

UK version. Remote control: HC-CARGO 161713.



Voltage/in: 12
 Voltage/out: 220-240
 Voltage/Alarm: 10.5±0.5
 Voltage/Shut down: 10±0.5
 Amp/max/cont.: 70
 Amp/standby: <0.9
 Watt/cont.: 700
 Watt/max.: 1400

Dim.: 340x135x79 mm
 Temp.: 60±5 °C
 Efficiency: >85 %

Type: Sinus
 Over heating: Yes
 Overloading: Yes
 Short circuit: Yes
 Approval: CE

161104 Voltage Inverter UK Std pkg 1

UK version. Remote control: HC-CARGO 161713.



Voltage/in: 24
 Voltage/out: 220-240
 Voltage/Alarm: 21±1
 Voltage/Shut down: 20±1
 Amp/max/cont.: 35
 Amp/standby: <0.6
 Watt/cont.: 700
 Watt/max.: 1400

Dim.: 340x135x79 mm
 Temp.: 60±5 °C
 Efficiency: >85 %

Type: Sinus
 Over heating: Yes
 Overloading: Yes
 Short circuit: Yes
 Approval: CE

161105 Voltage Inverter Std pkg 1

Remote control: HC-CARGO 161713.



Voltage/in: 12
 Voltage/out: 220-240
 Voltage/Alarm: 10.5±0.5
 Voltage/Shut down: 10±0.5
 Amp/max/cont.: 110
 Amp/standby: <1.3
 Watt/cont.: 1000
 Watt/max.: 2000

Dim.: 360x195x80 mm
 Temp.: 60±5 °C
 Efficiency: >85 %

Type: Sinus
 Over heating: Yes
 Overloading: Yes
 Short circuit: Yes
 Approval: CE

161106 Voltage Inverter Std pkg 1

Remote control: HC-CARGO 161713.



Voltage/in: 24
 Voltage/out: 220-240
 Voltage/Alarm: 21±1
 Voltage/Shut down: 20±1
 Amp/max/cont.: 55
 Amp/standby: <1
 Watt/cont.: 1000
 Watt/max.: 2000

Dim.: 360x195x80 mm
 Temp.: 60±5 °C
 Efficiency: >85 %

Type: Sinus
 Over heating: Yes
 Overloading: Yes
 Short circuit: Yes
 Approval: CE

	EL. SPECIFICATIONS	DIMENSIONS	ADDITIONAL SPECIFICATIONS
161107 Voltage Inverter UK Std pkg 1 <i>UK version. Remote control: HC-CARGO 161713.</i>	 <p>Voltage/in: 12 Voltage/out: 220-240 Voltage/Alarm: 10.5±0.5 Voltage/Shut down: 10±0.5 Amp/max/cont.: 110 Amp/standby: <1.3 Watt/cont.: 1000 Watt/max.: 2000</p>	<p>Dim.: 360x195x80 mm Temp.: 60±5 °C Efficiency: >85 %</p>	<p>Type: Sinus Over heating: Yes Overloading: Yes Short circuit: Yes Approval: CE</p>
161108 Voltage Inverter UK Std pkg 1 <i>UK version. Remote control: HC-CARGO 161713.</i>	 <p>Voltage/in: 24 Voltage/out: 220-240 Voltage/Alarm: 21±1 Voltage/Shut down: 20±1 Amp/max/cont.: 55 Amp/standby: <1 Watt/cont.: 1000 Watt/max.: 2000</p>	<p>Dim.: 360x195x80 mm Temp.: 60±5 °C Efficiency: >85 %</p>	<p>Type: Sinus Over heating: Yes Overloading: Yes Short circuit: Yes Approval: CE</p>
161109 Voltage Inverter Std pkg 1 <i>Remote control: HC-CARGO 161734.</i>	 <p>Voltage/in: 12 Voltage/out: 220-240 Voltage/Alarm: 10.5±0.5 Voltage/Shut down: 10±0.5 Amp/max/cont.: 160 Amp/standby: <1.3 Watt/cont.: 1500 Watt/max.: 3000</p>	<p>Dim.: 430x245x85 mm Temp.: 60±5 °C Efficiency: >85 %</p>	<p>Type: Sinus Over heating: Yes Overloading: Yes Short circuit: Yes Approval: CE</p>
161110 Voltage Inverter Std pkg 1 <i>Remote control: HC-CARGO 161734.</i>	 <p>Voltage/in: 24 Voltage/out: 220-240 Voltage/Alarm: 21±1 Voltage/Shut down: 20±1 Amp/max/cont.: 80 Amp/standby: <1 Watt/cont.: 1500 Watt/max.: 3000</p>	<p>Dim.: 430x245x85 mm Temp.: 60±5 °C Efficiency: >85 %</p>	<p>Type: Sinus Over heating: Yes Overloading: Yes Short circuit: Yes Approval: CE</p>
161111 Voltage Inverter UK Std pkg 1 <i>UK version. Remote control: HC-CARGO 161734.</i>	 <p>Voltage/in: 12 Voltage/out: 220-240 Voltage/Alarm: 10.5±0.5 Voltage/Shut down: 10±0.5 Amp/max/cont.: 160 Amp/standby: <1.3 Watt/cont.: 1500 Watt/max.: 3000</p>	<p>Dim.: 430x245x85 mm Temp.: 60±5 °C Efficiency: >85 %</p>	<p>Type: Sinus Over heating: Yes Overloading: Yes Short circuit: Yes Approval: CE</p>
161112 Voltage Inverter UK Std pkg 1 <i>UK version. Remote control: HC-CARGO 161734.</i>	 <p>Voltage/in: 24 Voltage/out: 220-240 Voltage/Alarm: 21±1 Voltage/Shut down: 20±1 Amp/max/cont.: 80 Amp/standby: <1 Watt/cont.: 1500 Watt/max.: 3000</p>	<p>Dim.: 430x245x85 mm Temp.: 60±5 °C Efficiency: >85 %</p>	<p>Type: Sinus Over heating: Yes Overloading: Yes Short circuit: Yes Approval: CE</p>
161113 Voltage Inverter Std pkg 1 <i>Remote control: HC-CARGO 161713.</i>	 <p>Voltage/in: 12 Voltage/out: 220-240 Voltage/Alarm: 10.5±0.5 Voltage/Shut down: 10±0.5 Amp/max/cont.: 250 Amp/standby: <0.8 Watt/cont.: 2500 Watt/max.: 5000</p>	<p>Dim.: 340x135x148 mm Temp.: 60±5 °C Efficiency: 85-90 %</p>	<p>Type: Modified sine Over heating: Yes Overloading: Yes Short circuit: Yes Approval: CE</p>

161114 Voltage Inverter Std pkg 1				
<i>Remote control: HC-CARGO 161713.</i>				
	Voltage/in: 24 Voltage/out: 220-240 Voltage/Alarm: 21±1 Voltage/Shut down: 20±1 Amp/max/cont.: 125 Amp/standby: <0.7 Watt/cont.: 2500 Watt/max.: 5000	Dim.: 340x135x148 mm Temp.: 60±5 °C Efficiency: 85-90 %	Type: Modified sine Over heating: Yes Overloading: Yes Short circuit: Yes Approval: CE	
161115 Voltage Inverter UK Std pkg 1				
<i>UK version. Remote control: HC-CARGO 161713.</i>				
	Voltage/in: 12 Voltage/out: 220-240 Voltage/Alarm: 10.5±0.5 Voltage/Shut down: 10±0.5 Amp/max/cont.: 250 Amp/standby: <0.8 Watt/cont.: 2500 Watt/max.: 5000	Dim.: 340x135x148 mm Temp.: 60±5 °C Efficiency: 85-90 %	Type: Modified sine Over heating: Yes Overloading: Yes Short circuit: Yes Approval: CE	
161116 Voltage Inverter UK Std pkg 1				
<i>UK version. Remote control: HC-CARGO 161713.</i>				
	Voltage/in: 24 Voltage/out: 220-240 Voltage/Alarm: 21±1 Voltage/Shut down: 20±1 Amp/max/cont.: 125 Amp/standby: <0.7 Watt/cont.: 2500 Watt/max.: 5000	Dim.: 340x135x148 mm Temp.: 60±5 °C Efficiency: 85-90 %	Type: Modified sine Over heating: Yes Overloading: Yes Short circuit: Yes Approval: CE	
161704 Voltage Inverter UK Version Std pkg 1				
<i>UK version.</i>				
	Voltage/in: 12 Voltage/out: 230 Voltage/Alarm: 10.5±0.5 Voltage/Shut down: 10±0.5 Amp/standby: <1.35 Watt/cont.: 600 Watt/max.: 1500	Dim.: 242x91x58 mm Temp.: 60±5 °C Regulation: ±10	Type: Modified sine Over heating: Yes Overloading: Yes Short circuit: Yes Approval: CE Alternativ no.: 161091	
161705 Voltage Inverter UK Version Std pkg 1				
<i>UK version. Remote Control: HC-CARGO 161045.</i>				
	Voltage/in: 10-15 Voltage/out: 230 Voltage/Alarm: 10.5±0.5 Voltage/Shut down: 10±0.5 Amp/standby: 1 Watt/cont.: 1500 Watt/max.: 3500	Dim.: 395x240x90 mm Temp.: 60±5 °C	Type: Modified sine Over heating: Yes Overloading: Yes Short circuit: Yes Approval: CE Alternativ no.: 161099	
161706 Voltage Inverter UK Version Std pkg 1				
<i>UK version. Remote Control: HC-CARGO 161045.</i>				
	Voltage/in: 10-15 Voltage/out: 230 Voltage/Alarm: 21±1 Voltage/Shut down: 20±1 Amp/standby: <1 Watt/cont.: 1500 Watt/max.: 3500	Dim.: 395x240x90 mm Temp.: 60±5 °C	Type: Modified sine Over heating: Yes Overloading: Yes Short circuit: Yes Approval: CE Alternativ no.: 161100	
161707 Voltage Inverter UK Version Std pkg 1				
<i>UK version.</i>				
	Voltage/in: 12 Voltage/out: 230 Voltage/Alarm: 10.5±0.5 Voltage/Shut down: 10±0.5 Amp/standby: <0.3 Watt/cont.: 1000 Watt/max.: 2500	Dim.: 310x205x75 mm Temp.: 60±5 °C Regulation: ±10	Type: Modified sine Over heating: Yes Overloading: Yes Short circuit: Yes Approval: CE Alternativ no.: 161095	

161710 Voltage Inverter UK Std pkg 1

UK version.

 Voltage/in: 24
 Voltage/out: 230
 Voltage/Alarm: 21±1
 Voltage/Shut down: 20±1
 Amp/standby: <0.8
 Watt/cont.: 1000
 Watt/max.: 2500

 Dim.: 310x205x75 mm
 Temp.: 60±5 °C
 Regulation: ±10

 Type: Modified sine
 Over heating: Yes
 Overloading: Yes
 Short circuit: Yes
 Approval: CE

ACCESSORIES
161045 Remote Control Std pkg 1 Servicing: HC-CARGO 160569, 161705, 160581,161706

161713 Remote control Std pkg 1 Servicing: HC-CARGO 161093..161118, 161113..161116

161734 Remote control Std pkg 1 Servicing: HC-CARGO 161109, 161110, 161111, 161112

VOLTAGE REDUCER
160627 Voltage Reducer Std pkg 1

Set w/ 2 resistors. Reduces the voltage w/ 0.75 V. Secures the lifetime of the headlight bulbs in cars w/ high voltage. 12/24 V.

161042 Voltage Reducer Std pkg 1

Protects electronics against voltage peaks.

Voltage: 12-14

 ID/mount. hole: 8 mm
 Length: 27 mm
 Width: 33 mm

LOAD RESISTORS

160970 Load Resistor 12 V Std pkg 1

Contains: 2 pcs.

 Voltage: 12
 Amp: 2
 Watt: 50
 Ohm: 6

 Length: 50 mm
 Width: 15 mm

160971 Load Resistor 24 V Std pkg 1

Contains: 2 pcs.

 Voltage: 24
 Amp: 1
 Watt: 50
 Ohm: 24

 Length: 50 mm
 Width: 15 mm

CHARGERS

160874 Charger Std pkg 1

 Voltage: 230/24
 Amp: 12

 Dim.: 235x87x58 mm
 Working temp.: -30 -
 +55 °C

 Warning lamp: w/
 Auto stop: Yes
 Protection degree: IP 67
 Approval: CE

160875 Charger Std pkg 1

 Voltage: 230/12
 Amp: 17

 Dim.: 235x87x58 mm
 Working temp.: -30 -
 +55 °C

 Warning lamp: w/
 Auto stop: Yes
 Protection degree: IP 67
 Approval: CE

161026 Charger Std pkg 1

Charger cable: HC-CARGO 160990.

 Voltage: 230/12
 Amp: 5
 Hertz: 50

 Dim.: 170x73x48 mm
 Working temp.: -20 -
 +50 °C

 Warning lamp: w/
 Protection degree: IP 65
 Approval: CE
 Alternativ no.: 160969

161122 Charger Std pkg 1

Servicing: All types of 12V LEAD ACID Batteries, (AGM, GEL, STD,VRLA, MF, CAL/CAL and START-STOP) & LFP batteries - Visit our web catalogue for further information

 Voltage: 220/240
 Amp: 1.5/10
 Amp/hour: 200
 Hertz: 50/60

 Dim.: 210x98x60 mm
 Working temp.: -20 -
 +50 °C

 Protection degree: IP 65
 Approval: CE







161123 Charger UK Std pkg 1

Servicing: All types of 12V LEAD ACID Batteries, (AGM, GEL, STD,VRLA, MF, CAL/CAL and START-STOP) & LFP batteries - Visit our web catalogue for further information

 Voltage: 220/240
 Amp: 10
 Amp/hour: 200
 Hertz: 50/60

 Dim.: 210x98x60 mm
 Working temp.: -20 -
 +50 °C

 Protection degree: IP 65
 Approval: CE

		EL. SPECIFICATIONS	DIMENSIONS	ADDITIONAL SPECIFICATIONS
161701 UK Charger Std pkg 1				
<i>Charger cable: HC-CARGO 160990.</i>				
	Voltage: 230/12 Amp: 5 Hertz: 50	Working temp.: -20 - +50 °C	Warning lamp: w/ Protection degree: IP 65 Approval: CE Alternativ no.: 161026UK	
181743 USB Adapter Std pkg 1 <i>Servicing: HC-CARGO 172187</i>				
	Voltage: 5 Amp: 0.5 Voltage/AC 1: 230		Approval: CE	
211035 Charger Std pkg 1				
<i>Test Connection: HC-CARGO 211077.</i>				
	Voltage: 6-12 Amp: 1.5-3	Dim.: 150x90x135 mm	Auto stop: No Approval: CE	
211036 Charger Std pkg 1				
<i>Test Connection: HC-CARGO 211077.</i>				
	Voltage: 12-24 Amp: 4-8	Dim.: 210x125x180 mm	Auto stop: No Approval: CE	
211073 Charger Std pkg 1				
<i>230 V. AC. Test Connection: HC-CARGO 211077.</i>				
	Voltage: 12-24 Amp: 8	Dim.: 235x140x180 mm	Auto stop: Yes Approval: CE	
ACCESSORIES				
161888 Charger cable Std pkg 1 <i>Servicing: HC-CARGO 161026, 161701, 161122</i>				
<i>w/ Fuse.</i>				
	Voltage: 300	Length: 300 mm Temp. area: 105 °C	Lead type: Dual Cap colour: Black Cap material: PVC	
211077 Test Connection Std pkg 1 <i>Servicing: HC-CARGO 211035, 211036, 211073</i>				
				

POWER GUARD
161014 Power Guard Std pkg 1

 Voltage/in: 12/24
 Voltage/Alarm: Yes
 Voltage/Shut down: Yes
 Shut down/12 V: 11.5
 Shut down/24 V: 23
 Amp/max/cont.: 10

 Dim.: 155x30x15 mm
 Regulation: Yes

 Connection: Connection
 Over heating: Yes
 Overloading: Yes
 Short circuit: Yes

161015 Power Guard Std pkg 1

 Voltage/in: 12/24
 Voltage/Alarm: Yes
 Voltage/Shut down: Yes
 Shut down/12 V: 11.5
 Shut down/24 V: 23
 Amp/max/cont.: 20

 Dim.: 155x30x15 mm
 Regulation: Yes

 Connection: Connection
 Over heating: Yes
 Overloading: Yes
 Short circuit: Yes

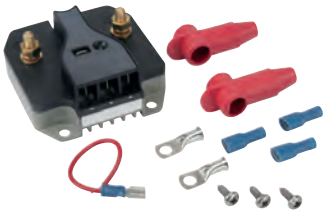
161016 Power Guard Std pkg 1

 Voltage/in: 12/24
 Voltage/Alarm: Yes
 Voltage/Shut down: Yes
 Shut down/12 V: 11.5
 Shut down/24 V: 23
 Amp/max/cont.: 40

 Dim.: 76x78x33 mm
 Regulation: Yes

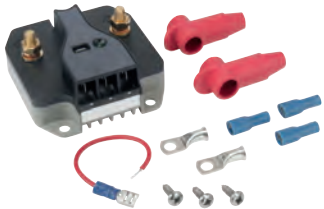
 Connection: M6
 Over heating: Yes
 Overloading: Yes
 Short circuit: Yes

161017 Power Guard Std pkg 1

 Voltage/in: 12/24
 Voltage/Alarm: Yes
 Voltage/Shut down: Yes
 Shut down/12 V: 11.5
 Shut down/24 V: 23
 Amp/max/cont.: 60

 Dim.: 76x78x33 mm
 Regulation: Yes

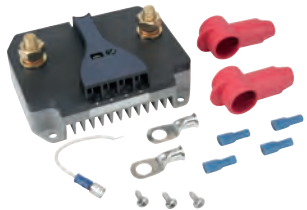
 Connection: M6
 Over heating: Yes
 Overloading: Yes
 Short circuit: Yes

161018 Power Guard Std pkg 1

 Voltage/in: 12/24
 Voltage/Alarm: Yes
 Voltage/Shut down: Yes
 Shut down/12 V: 11.5
 Shut down/24 V: 23
 Amp/max/cont.: 100

 Dim.: 124x97x51 mm
 Regulation: Yes

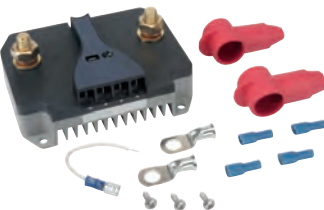
 Connection: M10
 Over heating: Yes
 Overloading: Yes
 Short circuit: Yes

161019 Power Guard Std pkg 1

 Voltage/in: 12/24
 Voltage/Alarm: Yes
 Voltage/Shut down: Yes
 Shut down/12 V: 11.5
 Shut down/24 V: 23
 Amp/max/cont.: 200

 Dim.: 124x97x51 mm
 Regulation: Yes

 Connection: M10
 Over heating: Yes
 Overloading: Yes
 Short circuit: Yes

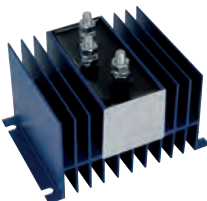





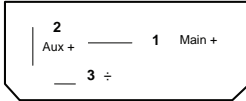

BATTERY ISOLATORS
160342 Battery Isolator Std pkg 1 Servicing: Boats, autocampers, industrial vehicles - Visit our web catalogue for further information

Eliminates the multi battery drain when 2 or more batteries are in a charging system.

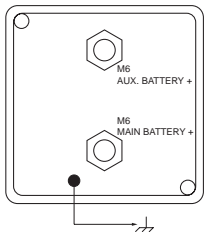
 Voltage: 6-36
 Amp/current max: 70

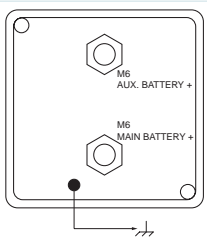



Dim.: 85x115x95 mm





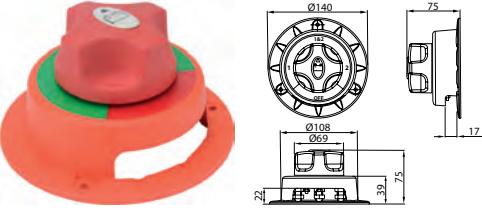
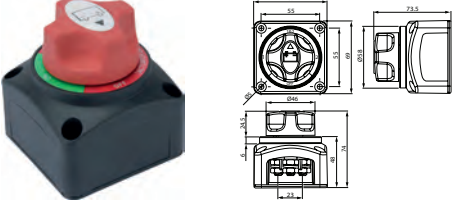
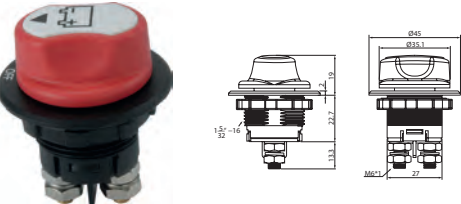

 No./batteries: 2
 Comp. diode: No

		EL. SPECIFICATIONS	DIMENSIONS	ADDITIONAL SPECIFICATIONS
160343 Battery Isolator Std pkg 1 Servicing: Boats, autocampers, industrial vehicles - Visit our web catalogue for further information				
<i>Eliminates the multi battery drain when 2 or more batteries are in a charging system. w/ compensationsdiode which allows a higher charging current.</i>				
	Voltage: 6-36 Amp/current max: 70	Dim.: 85x115x95 mm	No./batteries: 2 Comp. diode: Yes	
160398 Battery Isolator Std pkg 1 Servicing: Boats, autocampers, industrial vehicles - Visit our web catalogue for further information				
<i>Eliminates the multi battery drain when 2 or more batteries are in a charging system.</i>				
	Voltage: 6-36 Amp/current max: 120	Dim.: 170x115x95 mm	No./batteries: 2 Comp. diode: No	
160399 Battery Isolator Std pkg 1 Servicing: Boats, autocampers, industrial vehicles - Visit our web catalogue for further information				
<i>Eliminates the multi battery drain when 2 or more batteries are in a charging system. w/ compensationsdiode which allows a higher charging current.</i>				
	Voltage: 6-36 Amp/current max: 120	Dim.: 170x115x95 mm	No./batteries: 2 Comp. diode: Yes	
160740 Split Charge Relay 12V Std pkg 1 Servicing: Boats, autocampers, industrial vehicles, Nissan - Visit our web catalogue for further information				
<i>Microprocessor-controlled relay. Opens for charging the secondary battery when charger voltage reaches 13.4 V and closes at 12.5 V.</i>				
	Voltage: 12 Amp/current max: 180	Dim.: 120x80x55 mm	No./batteries: 2 Comp. diode: No	
160742 Split Charge Relay Std pkg 1 Servicing: Boats, autocampers, industrial vehicles - Visit our web catalogue for further information				
<i>Microprocessor-controlled relay. Opens for charging the secondary battery when charger voltage reaches 27 V and closes at 25.4 V.</i>				
	Voltage: 24 Amp/current max: 100	Dim.: 120x80x70 mm	No./batteries: 2 Comp. diode: No	
160876 Split Charge Relay Std pkg 1				
<i>Microprocessor-controlled relay. Opens for charging the secondary battery when charger voltage reaches 13.4 V and closes at 12.6 V.</i>				
	Voltage: 12 Amp/current max: 70	Dim.: 60x34x70 mm	No./batteries: 2 Comp. diode: No	

		EL. SPECIFICATIONS	DIMENSIONS	ADDITIONAL SPECIFICATIONS
160877 Split Charge Relay Std pkg 1  		Voltage: 24 Amp/current max.: 50	Dim.: 60x34x70 mm	No./batteries: 2 Comp. diode: No
161059 Split Charge Relay 12V Std pkg 1 <i>Microprocessor-controlled relay. Opens for charging the secondary battery when charger voltage reaches 13.3 V and closes at 12.8 V.</i>		  Voltage: 12 Amp/current max.: 140	Dim.: 67x67x50 mm	No./batteries: 2 Comp. diode: No
161060 Split Charge Relay Std pkg 1 <i>Microprocessor-controlled relay. Opens for charging the secondary battery when charger voltage reaches 26.6 V and closes at 25.6 V.</i>		  Voltage: 24 Amp/current max.: 140	Dim.: 67x67x50 mm	No./batteries: 2 Comp. diode: No
<h2>SWITCHES</h2> <h3>BATTERY SWITCHES</h3>				
180028 Battery Main Switch Std pkg 1 <i>Spare key: HC-CARGO 180028, 180143. Pole: dia. 10 mm.</i>		 Voltage: 24 Amp/5 sec.: 500 Amp/cont.: 100	Dist. mount. holes: 38 mm	Type: Battery Material: Plastic No./mounting holes: 2 Key: w/ Protection degree: IP 65
180087 Battery Main Switch Std pkg 1 <i>Spare key: HC-CARGO 180202.</i>		 Voltage: 24 Amp/5 sec.: 2500 Amp/cont.: 250	Dist. mount. holes: 100 mm	Type: Battery Material: Metal No./mounting holes: 2 Key: w/ Waterproof: Yes Protection degree: IP 66
180203 Battery Main Switch Std pkg 1 <i>Spare key: HC-CARGO 180029, 180619.</i>		 Voltage: 24 Amp/5 sec.: 2500 Amp/cont.: 250	Dist. mount. holes: 100 mm	Type: Battery Material: Plastic No./mounting holes: 2 No./poles: 2 Key: w/ Protection degree: IP 66

		EL. SPECIFICATIONS	DIMENSIONS	ADDITIONAL SPECIFICATIONS
180211 Battery Main Switch Std pkg 1				
Spare key: HC-CARGO 180288, 180333. Rubber boot: HC-CARGO 180375.				
 		Voltage: 24 Amp/5 sec.: 2500 Amp/cont.: 250	Dist. mount. holes: 100 mm	Type: Battery Material: Metal No./mounting holes: 2 Key: w/ Protection degree: IP 65 Alternativ no.: 181475
180216 Battery Main Switch Std pkg 1				
Spare key: HC-CARGO 180029, 180143, 180619, 181270. Rubber protection cap: HC-CARGO 180374.				
 		Voltage: 24 Amp/5 sec.: 500 Amp/cont.: 100	Dist. mount. holes: 39.5 mm	Type: Battery Material: Plastic No./mounting holes: 2 No./poles: M8 Key: w/ Protection degree: IP 40
180229 Battery Main Switch Std pkg 1				
Spare key: HC-CARGO 180029, 180619, 181270. On/Off under load.				
		Voltage: 24 Amp/5 sec.: 2500 Amp/cont.: 250	Dist. mount. holes: 100 mm	Type: Battery Material: Plastic No./mounting holes: 2 Key: w/ Protection degree: IP 66
180289 Battery Main Switch Std pkg 1				
Rubber boot: HC-CARGO 180375.				
		Voltage: 24 Amp/5 sec.: 2500 Amp/cont.: 250	Dist. mount. holes: 30 mm	Type: Battery Material: Metal No./mounting holes: 2 Key: w/ Protection degree: IP 65
180313 Battery Main Switch Std pkg 1				
Spare key: HC-CARGO 180029, 180143, 181270. Rubber protection cap: HC-CARGO 180374.				
 		Voltage: 24 Amp/5 sec.: 500 Amp/cont.: 100	Dist. mount. holes: 45 mm	Type: Battery No./mounting holes: 2 Key: w/o Protection degree: IP 40
180326 Battery Main Switch Std pkg 1				
Rubber boot: HC-CARGO 180375. w/ rotation/press handle.				
		Voltage: 24 Amp/5 sec.: 2500 Amp/cont.: 250	Dist. mount. holes: 100 mm	Type: Battery No./mounting holes: 2 Protection degree: IP 65
180596 Battery Main Switch Std pkg 1				
Spare key: HC-CARGO 180029, 180619.				
		Voltage: 24 Amp/5 sec.: 500 Amp/cont.: 100	Dist. mount. holes: 38 mm	Type: Battery Material: Plastic No./mounting holes: 2 Key: w/ Resistor: 3 Ohm, 11 W Sec. circuit: w/ Protection degree: IP 43

180614 Battery Main Switch		Std pkg 1			
<i>Spare key: HC-CARGO 181578.</i>					
		Voltage: 24 Amp/5 sec.: 1000 Amp/cont.: 75	Dist. mount. holes: 38 mm	Type: Battery Material: Metal No./mounting holes: 2 Key: w/ Protection degree: IP 41	
181475 Battery Main Switch		Std pkg 1			
<i>Spare key: HC-CARGO 180288, w/o chain and rubber cap. Rubber boot: HC-CARGO 180375.</i>					
		Voltage: 24 Amp/5 sec.: 2500 Amp/cont.: 250	Dist. mount. holes: 100 mm	Material: Metal No./mounting holes: 2 Key: w/ Protection degree: IP 65	
181613 Battery Main Switch		Std pkg 1			
		Voltage: 12-50 Amp/5 sec.: 1000 Amp/cont.: 200	Dist. mount. holes: 104 mm	Type: Battery Material: PBT No./mounting holes: 3 No./poles: 3 Key: w/o Protection degree: IP 54 Approval: CE	
181614 Battery Main Switch		Std pkg 1			
		Voltage: 12-50 Amp/5 sec.: 1000 Amp/cont.: 200	Dist. mount. holes: 55 mm	Type: Battery Material: PBT No./mounting holes: 4 No./poles: 2 Key: w/ Protection degree: IP 54 Approval: CE	
181687 Battery Main Switch		Std pkg 1	Servicing: HC-CARGO 181679, 181680, 181681		
		Voltage: <32 Amp/5 sec.: 500 Amp/cont.: 100	Dist. mount. holes: 27 mm	Type: Battery Material: PBT No./mounting holes: 2 No./poles: 2 Key: w/o	
WATERPROOF					
180271 Battery Main Switch		Std pkg 1			
<i>Rubber boot: HC-CARGO 180375. Working temp. -30°C/+65°C.</i>					
		Voltage: 12/24 Amp/5 sec.: 1000 Amp/cont.: 300	Dist. mount. holes: 45 mm	Type: Battery Material: Plastic Explosion proof/SAEJ1171: Yes No./mounting holes: 2 No./poles: M10 Key: w/ Waterproof: Yes Protection degree: IP 65 Approval: SAE J1171	
180272 Battery Main Switch		Std pkg 1	Servicing: Marine - Visit our web catalogue for further information		
<i>Spare key: HC-CARGO 180273. Rubber boot: HC-CARGO 180375.</i>					
		Voltage: 24 Amp/5 sec.: 1000 Amp/cont.: 150	Dist. mount. holes: 45 mm	Type: Battery Material: Metal Explosion proof/SAEJ1171: Yes No./mounting holes: 2 Key: w/ Waterproof: Yes Protection degree: IP 68	

180274 Battery Main Switch		Std pkg 1		
<i>Rubber boot: HC-CARGO 180375 . For alternator w/ separate regulator.</i>				
	Voltage: 24 Amp/5 sec.: 2500 Amp/cont.: 250	Dist. mount. holes: 65 mm	Type: Battery Material: Metal Explosion proof/SAEJ1171: Yes No./mounting holes: 2 Key: w/ Waterproof: Yes Protection degree: IP 67	
180275 Battery Main Switch		Std pkg 1		
<i>Rubber boot: HC-CARGO 180375. For alternator w/ intergral regulator. w/ D+ contact.</i>				
	Voltage: 24 Amp/5 sec.: 2500 Amp/cont.: 250	Dist. mount. holes: 65 mm	Type: Battery Material: Metal Explosion proof/SAEJ1171: Yes No./mounting holes: 2 Key: w/ Waterproof: Yes Protection degree: IP 67	
180276 Battery Main Switch		Std pkg 1		
<i>Rubber boot: HC-CARGO 180375. For alternator w/ intergral regulator. w/ D+ contact.</i>				
	Voltage: 24 Amp/5 sec.: 2500 Amp/cont.: 250	Dist. mount. holes: 110 mm	Type: Battery Material: Metal Explosion proof/SAEJ1171: Yes Explosion proof/EN50020(Eex IA): Yes No./mounting holes: 2 No./poles: 2 Key: w/ Waterproof: Yes Protection degree: IP 67 Approval: ADR	
180277 Battery Main Switch		Std pkg 1		
<i>Rubber boot: HC-CARGO 180375 . For alternator w/ separate regulator.</i>				
	Voltage: 24 Amp/5 sec.: 2500 Amp/cont.: 250	Dist. mount. holes: 110 mm	Type: Battery Material: Metal Explosion proof/SAEJ1171: Yes Explosion proof/EN50020(Eex IA): Yes No./mounting holes: 2 No./poles: 2 Key: w/ Waterproof: Yes Protection degree: IP 67	
180278 Battery Main Switch		Std pkg 1		
<i>Spare key: HC-CARGO 181477. Rubber boot: HC-CARGO 180375.</i>				
	Voltage: 24 Amp/5 sec.: 3000 Amp/cont.: 300	Dist. mount. holes: 100 mm	Type: Battery Material: Metal Explosion proof/SAEJ1171: Yes No./mounting holes: 2 Key: w/ Waterproof: Yes Protection degree: IP 68	
180338 Battery Main Switch		Std pkg 1		
<i>For alternator w/ separate regulator. w/ secondary circuit 24 V. Rubber boot: HC-CARGO 180375.</i>				
	Voltage: 24 Amp/5 sec.: 2500 Amp/cont.: 20	Dist. mount. holes: 65 mm	Type: Battery Material: Plastic Explosion proof/SAEJ1171: Yes No./mounting holes: 2 Key: w/ Sec. circuit: w/ Waterproof: Yes Protection degree: IP 67	

181238 Battery Main Switch Std pkg 1

Spare key: HC-CARGO 180333. Rubber boot: HC-CARGO 180375.



Voltage: 24
Amp/5 sec.: 2500
Amp/cont.: 250

Dist. mount. holes:
100 mm

Type: Battery
Material: Metal
No./mounting holes: 2
Key: w/
Waterproof: Yes
Protection degree: IP 66

181599 Battery Main Switch Std pkg 1

Rubber boot: HC-CARGO 180375. Spare key: HC-CARGO 181603.



Voltage: 12-24
Amp/5 sec.: 2500
Amp/cont.: 250

Dist. mount. holes:
120 mm

Type: Battery
Material: Metal
No./mounting holes: 2
No./poles: 4
Key: w/
Waterproof: Yes
Protection degree: IP 66

RUBBER BOOTS

180374 Terminal Boot Std pkg 10 Servicing: HC-CARGO 180216, 180313



Material: Rubber

180375 Terminal Boot set Std pkg 1 Servicing: HC-CARGO 180211, 180271, 180272, 180274, 180275, 180276, 180277, 180278, 180289, 180326, 180338, 180238, 181475, 181599

Supplied in kit of 2 pcs.



Material: Rubber

SPARE KEYS

180029 Key Std pkg 10 Servicing: HC-CARGO 180028, 180203, 180216, 180229, 180313, 180596



OD/shaft: 11 mm

No./pins: 2

180143 Key Std pkg 10 Servicing: HC-CARGO 180028, 180216, 180313





OD/shaft: 9 mm

180202 Key Std pkg 1 Servicing: HC-CARGO 180087



OD/shaft: 15 mm

		EL. SPECIFICATIONS	DIMENSIONS	ADDITIONAL SPECIFICATIONS
180273	Key	Std pkg 1 Servicing: HC-CARGO 180272		OD/shaft: 14 mm
				
180288	Key	Std pkg 5 Servicing: HC-CARGO 180211, 181475		OD/shaft: 14 mm No./pins: 2
				
180333	Key	Std pkg 5 Servicing: HC-CARGO 180211, 181238		OD/shaft: 14 mm No./pins: 1
				
180619	Key	Std pkg 10 Servicing: HC-CARGO 180028, 180203, 180216, 180229, 180596		OD/shaft: 11 mm No./pins: 1 Alternativ no.: 181270
				
181270	Key	Std pkg 10 Servicing: HC-CARGO 180028, 180216, 180229, 180313		OD/shaft: 11 mm No./pins: 1 Alternativ no.: 180619
				
181477	Key	Std pkg 1 Servicing: HC-CARGO 180278		OD/shaft: 11 mm
				
181578	Key	Std pkg 1 Servicing: HC-CARGO 180614		OD/shaft: 8 mm
<i>For battery main switch.</i>				
				

181603 Key Std pkg 1 Servicing: HC-CARGO 181599

For battery main switch.



OD/shaft: 15 mm

ELECTROMAGNETIC

180232 Battery Switch Std pkg 1 Servicing: Industrial vehicles, buses, tractors, lift trucks and boats - Visit our web catalogue for further information

These devices are designed to disconnect and protect the batteries and all the vehicle's electrical circuits. Depending on the model, the isolation switches are able to disconnect either the negative, the positive or both sides of the battery. The models with separate coil power supply can also be used to disconnect any other type of electrical circuit (e.g. marine applications). For serial or parallel connected batteries 250 Amp. Continued, 2500 Amp. For 5 sec. negative disconnection.

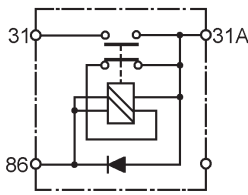

Voltage: 12
Amp/5 sec.: 2500
Amp/cont.: 250

Type: Electromagnetic
Switch: Negative
Protection degree: IP 65

180233 Battery Switch Std pkg 1 Servicing: Industrial vehicles, buses, tractors, lift trucks and boats - Visit our web catalogue for further information

These devices are designed to disconnect and protect the batteries and all the vehicle's electrical circuits. Depending on the model, the isolation switches are able to disconnect either the negative, the positive or both sides of the battery. The models with separate coil power supply can also be used to disconnect any other type of electrical circuit (e.g. marine applications). For serial or parallel connected batteries 250 Amp. Continued, 2500 Amp. For 5 sec. negative disconnection.

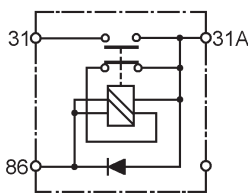

Voltage: 24
Amp/5 sec.: 2500
Amp/cont.: 250

Type: Electromagnetic
Switch: Negative
Protection degree: IP 65

180290 Battery Switch Std pkg 1

For serial and parallel connction of two 12 V batteries in 12 V systems w/ 24 V starter.



Voltage: 12/24
Amp/5 sec.: 1500
(1 sec)
Amp/cont.: 75

180556 Battery Switch Std pkg 1

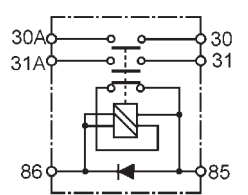

Voltage: 24
Amp/5 sec.: 2500
Amp/cont.: 250





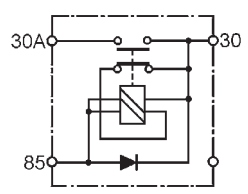



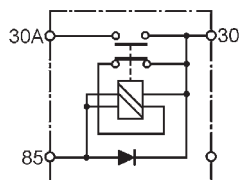

Type: Electromagnetic
Switch: Positive/negative
Protection degree: IP 65

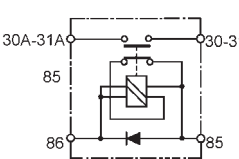
180602 Battery Switch Std pkg 1

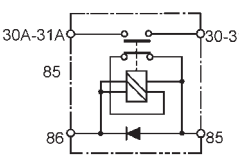

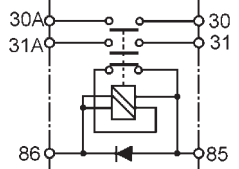
Voltage: 12
Amp/5 sec.: 2500
Amp/cont.: 250

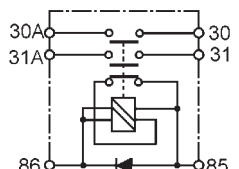
Type: Electromagnetic
Switch: Positive
Protection degree: IP 65

180603 Battery Switch Std pkg 1			
		Voltage: 24 Amp/5 sec.: 2500 Amp/cont.: 200	Type: Electromagnetic Switch: Positive Protection degree: IP 65
180604 Battery Switch Std pkg 1			
		Voltage: 12 Amp/5 sec.: 2500 Amp/cont.: 250	Type: Electromagnetic Switch: Positive/negative Protection degree: IP 65
180605 Battery Switch Std pkg 1 <i>w/ seperate power supply.</i>			
		Voltage: 24 Amp/5 sec.: 2500 Amp/cont.: 200	Type: Electromagnetic Switch: Positive/negative No./mounting holes: 4 Protection degree: IP 65
181476 Battery Switch Std pkg 1 <i>Plug: HC-CARGO 181545.</i>			
		Voltage: 24 Amp/5 sec.: 2500 Amp/cont.: 250	Type: Electromagnetic Explosion proof/SAEJ1171: Yes Explosion proof/EN50020(Eex IA): Yes Switch: Positive/negative No./mounting holes: 4 No./poles: 4 Protection degree: IP 65 Approval: Ex
181562 Battery Switch Std pkg 1			
		Voltage: 12 Amp/5 sec.: 2500 Amp/cont.: 250	Switch: Positive/negative Comp. diode: Yes Protection degree: IP 65
EMERGENCY STOP SWITCHES			
181247 Emergency Stop Button Std pkg 1 <i>Emergency stop button operable w/ push button, turn for reset.</i>			
			Protection degree: IP 65
181271 Emergency Stop Button Std pkg 1 <i>Emergency stop button operable w/ push button, turn for reset.</i>			
	Voltage: 48 Amp: 150	Mount. hole size: 37 mm	Type/terminal: Screw Protection degree: IP 66

CONTROL BOXES
181244 Control Box Std pkg 1

 Voltage/AC 1: 220
 Voltage/DC 1: 24
 Voltage/AC 2: 380
 Voltage/DC 2: 48
 Voltage/AC 3: 500
 Voltage/DC 3: 100
 Amp/max 1: 5
 Amp/max 2: 4.5
 Amp/max 3: 4
 Amp/max 4: 3
 Amp/max 5: 2

 No./buttons: 2
 Protection degree: IP 65

181245 Control Box Std pkg 1

 Voltage/AC 1: 220
 Voltage/DC 1: 24
 Voltage/AC 2: 380
 Voltage/DC 2: 48
 Voltage/AC 3: 500
 Voltage/DC 3: 100
 Amp/max 1: 5
 Amp/max 2: 4.5
 Amp/max 3: 4
 Amp/max 4: 3
 Amp/max 5: 2

 No./buttons: 3
 Protection degree: IP 65

181246 Control Box Std pkg 1

 Voltage/AC 1: 220
 Voltage/DC 1: 24
 Voltage/AC 2: 380
 Voltage/DC 2: 48
 Voltage/AC 3: 500
 Voltage/DC 3: 100
 Amp/max 1: 5
 Amp/max 2: 4.5
 Amp/max 3: 4
 Amp/max 4: 3
 Amp/max 5: 2

 No./buttons: 2
 Protection degree: IP 65

181540 Remote Lift Control Set Std pkg 1 Servicing: Lift, doors, ports, winches, hoists etc - Visit our web catalogue for further information
 Set of hand transmitter, receiver and antenna. Individual coding. Coverage 50-125 m. w/o emergency stop.

 Voltage/AC 1: 12
 Voltage/DC 1: 12
 Voltage/AC 2: 24
 Voltage/DC 2: 24

 No./buttons: 3
 Protection degree: IP 65

181577 Control Box Std pkg 1

For tail lift.

 Voltage/DC 1:
 12-24





 No./buttons: 3
 Protection degree: IP 65

IGNITION/LIGHT
180045 Ignition/Light Switch Std pkg 1

Spare key: HC-CARGO 180341.

 Mount. hole size:
 26.5 mm

 Switch combination: Parkinglight-off-
 ignition-sidelight-DRL
 No./keys: 2
 Terminals: 6

180324 Ignition/Light Switch Std pkg 1 <i>Spare key: HC-CARGO 180341.</i>			
		Mount. hole size: 26.5 mm	Switch combination: Parkinglight-off-ignition-sidelight-DRL No./keys: 2 Terminals: 7
IGNITION STARTER			
180025 Ignition Starter Switch Std pkg 1 <i>Spare key: HC-CARGO 180339.</i>			
		Mount. hole size: 18.5 mm	Switch combination: Off-ignition No./keys: 2 Terminals: 3
180027 Ignition Starter Switch Std pkg 1 <i>Spare key: HC-CARGO 180339. Multi plug: HC-CARGO 181597.</i>			
		Mount. hole size: 18.5 mm	Switch combination: Off-ignition-start No./keys: 2 Terminals: 5
180041 Ignition Starter Switch Std pkg 1 <i>Spare key: HC-CARGO 180340.</i>			
		Mount. hole size: 26.5 mm	Switch combination: Parking light-off-start No./keys: 2 Terminals: 7 Protection degree: IP 63 DIN norm: 40050
180043 Ignition Starter Switch Std pkg 1 <i>Spare key: HC-CARGO 180339.</i>			
		Mount. hole size: 18.5 mm	Switch combination: Off-aux-ignition-start No./keys: 2 Terminals: 4
181518 Ignition Starter Switch Std pkg 1 <i>Spare key: HC-CARGO 180339.</i>			
		Mount. hole size: 22.5 mm	Switch combination: Off-ignition-start No./keys: 2 Terminals: 5 Positions: 1

DIESEL STARTER

180044 Ignition Switch Std pkg 1 Servicing: Deutz, IH - Visit our web catalogue for further information

Supplied w/ 2 keys. Spare key: HC-CARGO 180340. Multi plug: HC-CARGO 181595, 181596. Rubber Boot: HC-CARGO 181598.



Mount. hole size:
26.5 mm

Switch combination: Parking light-off-ignition-glow-start
Terminals: 10
Protection degree: IP 63
DIN norm: 40050

181235 Ignition Switch Std pkg 1 Servicing: Massey Ferguson - Visit our web catalogue for further information

Spare Key: HC-CARGO 181465. 1=30. 2=15. 3=19.



Mount. hole size:
16 mm

Switch combination: Off-ignition-glow-start
No./keys: 2
Terminals: 6
Positions: 4

181236 Ignition Switch Std pkg 1 Servicing: Massey Ferguson - Visit our web catalogue for further information

Spare key: HC-CARGO 181465.



Mount. hole size:
16 mm

Switch combination: Start-Off-Glow-Start
No./keys: 2
Terminals: 4
Positions: 4

181237 Ignition Switch Std pkg 1 Servicing: Massey Ferguson - Visit our web catalogue for further information

Spare key: HC-CARGO 181465.



Mount. hole size:
16 mm

Switch combination: Off-aux-ignition-glow-start
No./keys: 2
Terminals: 7
Positions: 5

RUBBER BOOTS

181598 Rubber Boot Std pkg 1 Servicing: HC-CARGO 180044









SPARE PARTS

180339 Spare Key Std pkg 10 Servicing: HC-CARGO 180025, 180027, 180043, 181518



		EL. SPECIFICATIONS	DIMENSIONS	ADDITIONAL SPECIFICATIONS
180340	Spare Key	Std pkg 10	Servicing: HC-CARGO 180041, 180044	
				
180341	Spare Key	Std pkg 10	Servicing: HC-CARGO 180045, 180324	
				
181465	Spare Key	Std pkg 10	Servicing: HC-CARGO 181235, 181236, 181237	
				Material: Metal
181595	Central Plug Connector	Std pkg 5	Servicing: HC-CARGO 180044	
<i>DIN 46340. Used w/ HC-CARGO 181596.</i>				
				Type: Socket Type/terminal: 9.5x1.2 Colour: Black No./poles: 4 Plug: Female
181596	Central Plug Connector	Std pkg 5	Servicing: HC-CARGO 180044	
<i>DIN 46340. Used w/ HC-CARGO 181595.</i>				
				Type: Socket Type/terminal: 6.3x0.8 Colour: Black No./poles: 6 Plug: Female
181597	Central Plug Connector	Std pkg 5	Servicing: HC-CARGO 180027	
				Type: Socket Colour: Black No./poles: 6 Plug: Female
SOLENOIDS				
SOLENOID SHUTDOWN-KITS				
EXTERNALLY SWITCHED				
090095	Solenoid Shutdown Kit	Std pkg 1		
<i>This solenoid can't switch off by itself, it will have to be controlled externally.</i>				
		Voltage: 12 Amp/hold: 1.1 Amp/pull: 46	Pull rating: 89N at 25.4 mm Mount. side: Left Hold rating: 178N	Elect. connection: Cable Function: Pull Mount. type: Flange/bracket Switch: External

		EL. SPECIFICATIONS	DIMENSIONS	ADDITIONAL SPECIFICATIONS
090096 Solenoid Shutdown Kit Std pkg 1				
<i>This solenoid can't switch off by itself, it will have to be controlled externally.</i>				
	Voltage: 12 Amp/hold: 1.1 Amp/pull: 46	Pull rating: 89N at 25.4 mm Mount. side: Right Hold rating: 178N	Elect. connection: Cable Function: Pull Mount. type: Flange/bracket Switch: External	
090099 Solenoid Shutdown Kit Std pkg 1				
<i>This solenoid can't switch off by itself, it will have to be controlled externally.</i>				
	Voltage: 24 Amp/hold: 0.5 Amp/pull: 25	Pull rating: 89N at 25.4 mm Mount. side: Left Hold rating: 178N	Elect. connection: Cable Function: Pull Mount. type: Flange/bracket Switch: External	
090100 Solenoid Shutdown Kit Std pkg 1				
<i>This solenoid can't switch off by itself, it will have to be controlled externally.</i>				
	Voltage: 24 Amp/hold: 0.5 Amp/pull: 25	Pull rating: 89N at 25.4 mm Mount. side: Right Hold rating: 178N	Elect. connection: Cable Function: Pull Mount. type: Flange/bracket Switch: External	
090103 Solenoid Shutdown Kit Std pkg 1 Servicing: Nippondenso, Zexel - Visit our web catalogue for further information				
<i>This solenoid can't switch off by itself, it will have to be controlled externally.</i>				
	Voltage: 12 Amp/hold: 1.1 Amp/pull: 55	Pull rating: 89N at 25.4 mm Mount. side: Left Hold rating: 178N	Elect. connection: Cable Function: Pull Mount. type: Flange/bracket Switch: External	
090104 Solenoid Shutdown Kit Std pkg 1 Servicing: Nippondenso, Zexel - Visit our web catalogue for further information				
<i>This solenoid can't switch off by itself, it will have to be controlled externally.</i>				
	Voltage: 12 Amp/hold: 1.1 Amp/pull: 55	Pull rating: 89N at 25.4 mm Mount. side: Right Hold rating: 178N	Elect. connection: Cable Function: Pull Switch: External	
090105 Solenoid Shutdown Kit Std pkg 1 Servicing: Nippondenso, Zexel - Visit our web catalogue for further information				
<i>This solenoid can't switch off by itself, it will have to be controlled externally.</i>				
	Voltage: 24 Amp/hold: 0.63 Amp/pull: 29	Pull rating: 89N at 25.4 mm Mount. side: Left Hold rating: 178N	Elect. connection: Cable Function: Pull Switch: External	
090106 Solenoid Shutdown Kit Std pkg 1 Servicing: Nippondenso, Zexel - Visit our web catalogue for further information				
<i>This solenoid can't switch off by itself, it will have to be controlled externally.</i>				
	Voltage: 24 Amp/hold: 0.63 Amp/pull: 29	Pull rating: 89N at 25.4 mm Mount. side: Right Hold rating: 178N	Elect. connection: Cable Function: Pull Switch: External	

090107 Solenoid Shutdown Kit Std pkg 1

This solenoid can't switch off by itself, it will have to be controlled externally.



Voltage: 12
Amp/hold: 1.1
Amp/pull: 55

Pull rating:
89N at 25.4 mm
Mount. side: Left
Hold rating: 178N

Elect. connection: Multiplug
Function: Pull
Switch: External

090108 Solenoid Shutdown Kit Std pkg 1

This solenoid can't switch off by itself, it will have to be controlled externally.



Voltage: 24
Amp/hold: 0.63
Amp/pull: 29

Pull rating:
89N at 25.4 mm
Mount. side: Left
Hold rating: 178N

Elect. connection: Multiplug
Function: Pull
Switch: External

INTERNALLY SWITCHED

090097 Solenoid Shutdown Kit Std pkg 1

This solenoid can switch off the pull coil, and no external 'control' is necessary.



Voltage: 12
Amp/hold: 1.1
Amp/pull: 46

Pull rating:
89N at 25.4 mm
Mount. side: Left
Hold rating: 178N

Elect. connection: Plug
Function: Pull
Mount. type: Flange/bracket
Switch: Internal

090098 Solenoid Shutdown Kit Std pkg 1

This solenoid can switch off the pull coil, and no external 'control' is necessary.



Voltage: 12
Amp/hold: 1.1
Amp/pull: 46

Pull rating:
89N at 25.4 mm
Mount. side: Right
Hold rating: 178N

Elect. connection: Plug
Function: Pull
Switch: Internal

090101 Solenoid Shutdown Kit Std pkg 1

This solenoid can switch off the pull coil, and no external 'control' is necessary.



Voltage: 24
Amp/hold: 0.5
Amp/pull: 25

Pull rating:
89N at 25.4 mm
Mount. side: Left
Hold rating: 178N

Elect. connection: Plug
Function: Pull
Switch: Internal

090102 Solenoid Shutdown Kit Std pkg 1

This solenoid can switch off the pull coil, and no external 'control' is necessary.



Voltage: 24
Amp/hold: 0.5
Amp/pull: 25

Pull rating:
89N at 25.4 mm
Hold rating: 178N

Elect. connection: Plug
Function: Pull
Switch: Internal

SOLENOID SHUTDOWN EXTERNALLY SWITCHED

090109 Shutdown Solenoid Std pkg 1

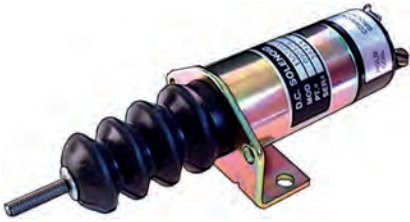
This solenoid can't switch off by itself, it will have to be controlled externally.

 Voltage: 12
 Amp/hold: 0.7
 Amp/pull: 30

 Thread size: 6
 Thread type: mm
 Pull rating:
 40N at 25.4 mm
 Return spring: 9N
 Hold rating: 89N

 Plunger: External
 Elect. connection: Plug
 Function: Pull
 Mount. type: Flange/bracket
 Switch: External

090110 Shutdown Solenoid Std pkg 1

This solenoid can't switch off by itself, it will have to be controlled externally. Supplied with 2 plungers 1/4" and M6 thread Thread: 1/4" and M6

 Voltage: 24
 Amp/hold: 0.25
 Amp/pull: 17

 Thread size: 6
 Thread type: mm
 Pull rating:
 40N at 25.4 mm
 Return spring: 9N
 Hold rating: 89N

 Plunger: External
 Elect. connection: Plug
 Function: Pull
 Mount. type: Flange/bracket
 Switch: External

090111 Shutdown Solenoid Std pkg 1

This solenoid can't switch off by itself, it will have to be controlled externally.

 Voltage: 12
 Amp/hold: 0.6
 Amp/pull: 44

 Thread size: 1/4"
 Thread type: Inches
 Pull rating:
 75N at 25.4 mm
 Return spring: 35N
 Hold rating: 178N

 Plunger: External
 Elect. connection: Plug
 Function: Pull
 Mount. type: Flange/bracket
 Switch: External

090113 Shutdown Solenoid Std pkg 1

This solenoid can't switch off by itself, it will have to be controlled externally.

 Voltage: 24
 Amp/hold: 0.3
 Amp/pull: 23

 Thread size: 6
 Thread type: mm
 Pull rating:
 75N at 25.4 mm
 Return spring: 35N
 Hold rating: 178N

 Plunger: External
 Elect. connection: Plug
 Function: Pull
 Mount. type: Flange/bracket
 Switch: External
 Aux terminal: Yes

090199 Shutdown Solenoid Std pkg 1

This solenoid can't switch off by itself, it will have to be controlled externally.

 Voltage: 12
 Amp/hold: 1.1
 Amp/pull: 46

 Thread size: 6
 Thread type: mm
 Pull rating:
 89N at 25.4 mm
 Return spring: 17N
 Hold rating: 178N

 Plunger: External
 Elect. connection: Cable
 Function: Pull/Push
 Mount. type: Flat w/ 2 fixing holes
 Switch: External







090200 Shutdown Solenoid Std pkg 1

This solenoid can't switch off by itself, it will have to be controlled externally.

 Voltage: 24
 Amp/hold: 4
 Amp/pull: 18

 Thread size: 6
 Thread type: mm
 Pull rating:
 67N at 25.4 mm
 Return spring: 17N
 Hold rating: 178N

 Plunger: External
 Elect. connection: Cable
 Function: Pull/Push
 Switch: External

		EL. SPECIFICATIONS	DIMENSIONS	ADDITIONAL SPECIFICATIONS
090206 Shutdown Solenoid Std pkg 1 Servicing: Yanmar Diesel - Visit our web catalogue for further information				
<i>This solenoid can't switch off by itself, it will have to be controlled externally.</i>				
	Voltage: 12 Amp/hold: 0.49 Amp/pull: 36.5	Thread size: 0.158 Thread type: Inches	Plunger: Internal Switch: External	
090216 Shutdown Solenoid Std pkg 1 Servicing: Kubota - Visit our web catalogue for further information				
<i>This solenoid can't switch off by itself, it will have to be controlled externally.</i>				
	Voltage: 12 Amp/hold: 0.7 Amp/pull: 30	Pull rating: 44N at 25.4mm Return spring: 17N Hold rating: 85N	Plunger: External Elect. connection: Multiplug Mount. type: Flange Switch: External	
090225 Shutdown Solenoid Std pkg 1 Servicing: Perkins - Visit our web catalogue for further information				
<i>This solenoid can't switch off by itself, it will have to be controlled externally.</i>				
	Voltage: 12 Amp/hold: 0.49 Amp/pull: 36.5	Thread size: 0.25 Thread type: Inches	Plunger: Internal Switch: External	
090226 Shutdown Solenoid Std pkg 1				
<i>This solenoid can't switch off by itself, it will have to be controlled externally.</i>				
	Voltage: 24 Voltage 2: 24 Amp/hold: 0.5 Amp/pull: 25	Thread size: 6 Thread type: mm Pull rating: 111N at 25.4 mm Return spring: 7N Hold rating: 182N	Plunger: External Elect. connection: Multiplug Function: Pull Switch: External	
090228 Shutdown Solenoid Std pkg 1 Servicing: Yanmar Motors - Visit our web catalogue for further information				
<i>This solenoid can't switch off by itself, it will have to be controlled externally.</i>				
	Voltage: 12 Amp/hold: 0.49 Amp/pull: 36.5		Plunger: Internal Switch: External	
090267 Shutdown Solenoid Std pkg 1 Servicing: Volvo wheel loader - Visit our web catalogue for further information				
<i>Syncro start/Woodward.</i>				
	Voltage: 24 Amp/hold: 0.86 Amp/pull: 39	Pull rating: 129N at 25.4 mm Hold rating: 182N	Plunger: Cable Elect. connection: Multiplug Function: Pull Switch: External	
090281 Shutdown Solenoid Std pkg 1 Servicing: Volvo - Visit our web catalogue for further information				
<i>This solenoid can't switch off by itself, it will have to be controlled externally.</i>				
	Voltage: 24 Amp/hold: 0.5 Amp/pull: 25	Thread size: 6 Thread type: mm Pull rating: 89N at 25.4 mm Hold rating: 236N	Plunger: External Elect. connection: Multiplug Function: Pull/Push Mount. type: Bracket Switch: External	

090348 Shutdown Solenoid Std pkg 1

This solenoid can't switch off by itself, it will have to be controlled externally.



Voltage: 12
Amp/hold: 1.1
Amp/pull: 46

Thread size: 6
Thread type: mm
Pull rating:
111N at 25.4 mm
Return spring: 4-8N
Hold rating: 182N

Plunger: External
Elect. connection: Cable
Function: Pull
Mount. type: Flat w/ 2 fixing holes
Switch: External

090370 Shutdown Solenoid Std pkg 1 Servicing: Kubota D722, Z482 - Visit our web catalogue for further information

This solenoid can't switch off by itself, it will have to be controlled externally.



Voltage: 12
Amp/hold: 1.1
Amp/pull: 46

Thread size:
1/4 - 28 UNF-2A
Pull rating: 111N
Hold rating: 182N

Plunger: External
Elect. connection: Cable
Mount. type: Flat w/ 2 fixing holes
Switch: External

090371 Shutdown Solenoid Std pkg 1 Servicing: Kubota D722, Z482 - Visit our web catalogue for further information

This solenoid can't switch off by itself, it will have to be controlled externally.



Voltage: 24
Amp/hold: 0.5
Amp/pull: 25

Thread size:
1/4 - 28 UNF-2A
Pull rating: 111N
Hold rating: 182N

Plunger: External
Elect. connection: Cable
Switch: External

090373 Shutdown Solenoid Std pkg 1

This solenoid can't switch off by itself, it will have to be controlled externally.



Voltage: 12
Amp/hold: 0.972
Amp/pull: 36.5

Thread size: 0.154
Thread type: Inches

Plunger: External
Switch: External

090431 Shutdown Solenoid Std pkg 1

This solenoid can't switch off by itself, it will have to be controlled externally.



Voltage: 24
Voltage 2: 24
Amp/hold: 0.57
Amp/pull: 30

Thread size: 5/16"
Thread type: Inches
Pull rating: 165N
Return spring: 80-115N
Hold rating: 391N

Plunger: External
Function: Pull
Mount. type: Flange/bracket
Switch: External
Insulated return: Yes

090439 Shutdown Solenoid Std pkg 1

This solenoid can switch off the pull coil, and no external 'control' is necessary.



Voltage: 12
Amp/hold: 0.76
Amp/pull: 41.4

Thread size: 6
Thread type: mm
Pull rating:
49N at 25.4 mm
Hold rating: 89N

Plunger: Internal
Switch: Internal

SPARE PARTS

090218 Plunger Std pkg 1



Thread size: M6
Thread type: Ordinary

Plunger: External

INTERNALLY SWITCHED
090160 Shutdown Solenoid Std pkg 1

This solenoid can switch off the pull coil, and no external 'control' is necessary.

 Voltage: 12
 Amp/hold: 0.7
 Amp/pull: 30

 Thread size: 6
 Thread type: mm
 Pull rating:
 40N at 25.4 mm
 Return spring: 17N
 Hold rating: 89N

 Plunger: External
 Elect. connection: Plug
 Mount. type: Flange/bracket
 Switch: Internal

090161 Shutdown Solenoid Std pkg 1

This solenoid can switch off the pull coil, and no external 'control' is necessary.

 Voltage: 24
 Amp/hold: 0.25
 Amp/pull: 17

 Thread size: 6
 Thread type: mm
 Pull rating:
 40N at 25.4 mm
 Return spring: 17N
 Hold rating: 89N

 Plunger: Internal
 Elect. connection: Plug
 Function: Pull
 Mount. type: Flange/bracket
 Switch: Internal

090168 Shutdown Solenoid Std pkg 1

This solenoid can switch off the pull coil, and no external 'control' is necessary.

 Voltage: 12
 Amp/hold: 0.6
 Amp/pull: 44

 Thread size: 6
 Thread type: mm
 Pull rating:
 75N at 25.4 mm
 Return spring: 35N
 Hold rating: 178N

 Plunger: External
 Elect. connection: Plug
 Mount. type: Flange/bracket
 Switch: Internal

090169 Shutdown Solenoid Std pkg 1

This solenoid can switch off the pull coil, and no external 'control' is necessary.

 Voltage: 24
 Amp/hold: 0.3
 Amp/pull: 23

 Thread size: 6
 Thread type: mm
 Pull rating:
 75N at 25.4 mm
 Return spring: 35N
 Hold rating: 178N

 Plunger: External
 Elect. connection: Plug
 Function: Pull
 Mount. type: Flange/bracket
 Switch: Internal
 Aux terminal: Yes

090210 Shutdown Solenoid Std pkg 1

This solenoid can switch off the pull coil, and no external 'control' is necessary.

 Voltage: 12
 Amp/hold: 1.1
 Amp/pull: 46

 Thread size:
 1/4"-28 stud.
 Thread type: Inches
 Pull rating:
 89N at 25.4 mm
 Return spring: 9N
 Hold rating: 178N

 Plunger: Internal
 Elect. connection: Plug
 Function: Pull
 Mount. type: Flange/bracket
 Switch: Internal
 Aux terminal: Yes

090224 Shutdown Solenoid Std pkg 1

This solenoid can switch off the pull coil, and no external 'control' is necessary.

 Voltage: 12
 Amp/hold: 0.25
 Amp/pull: 17

 Thread size: 6
 Thread type: mm
 Pull rating:
 40N at 25.4 mm
 Return spring: 17N
 Hold rating: 89N

 Plunger: Internal
 Switch: Internal
 Alternativ no.: 090442

090268 Shutdown Solenoid Std pkg 1 Servicing: Kubota 5 series - Visit our web catalogue for further information

This solenoid can switch off the pull coil, and no external 'control' is necessary.



Voltage: 12
Amp/hold: 0.49
Amp/pull: 36.5

Thread size: 0.155
Thread type: Inches

Plunger: Internal
Switch: Internal

090297 Shutdown Solenoid Std pkg 1

This solenoid can switch off the pull coil, and no external 'control' is necessary.



Voltage: 24
Amp/hold: 1.1
Amp/pull: 46

Thread size: 6
Thread type: mm
Pull rating:
107N at 25.4 mm
Return spring: 7-11N
Hold rating: 169N

Plunger: External
Switch: Internal
Aux terminal: No

090317 Shutdown Solenoid Std pkg 1

This solenoid can switch off the pull coil, and no external 'control' is necessary.



Voltage: 24
Amp/hold: 0.3
Amp/pull: 20

Pull rating:
98N at 32 mm
Return spring: 45N
Hold rating: 245N

Plunger: Internal
Switch: Internal
Coil commander: w/

090318 Shutdown Solenoid Std pkg 1

This solenoid can switch off the pull coil, and no external 'control' is necessary.



Voltage: 12
Amp/hold: 0.65
Amp/pull: 37

Pull rating:
98N at 32 mm
Return spring: 45N
Hold rating: 245N

Plunger: Internal
Switch: Internal

090334 Shutdown Solenoid Std pkg 1 Servicing: Sisu Diesel 8366 40253 - Visit our web catalogue for further information

This solenoid can switch off the pull coil, and no external 'control' is necessary.



Voltage: 12
Amp/hold: 1.1
Amp/pull: 46.5

Pull rating: 89N
Hold rating: 178N

Plunger: Internal
Switch: Internal

090402 Shutdown Solenoid Std pkg 1 Servicing: Kubota super 5 series - Visit our web catalogue for further information

This solenoid can switch off the pull coil, and no external 'control' is necessary.



Voltage: 24
Amp/hold: 0.59
Amp/pull: 19.6

Thread size: 0.154
Thread type: Inches

Plunger: Internal
Switch: Internal

090430 Shutdown Solenoid Std pkg 1 Servicing: Kubota - Visit our web catalogue for further information

This solenoid can switch off the pull coil, and no external 'control' is necessary.



Voltage: 12
Amp/hold: 0.49
Amp/pull: 36.5



Thread size: 0.158
Thread type: Inches

Plunger: Internal
Switch: Internal

		EL. SPECIFICATIONS	DIMENSIONS	ADDITIONAL SPECIFICATIONS
090442 Shutdown Solenoid Std pkg 1				Alternativ no.: 090224
				
PULL COIL TIMER MODULES				
090115 Pull Coil Timer Std pkg 1		Voltage: 12		No./wires: 3
				
090116 Pull Coil Timer Std pkg 1		Voltage: 24		No./wires: 3
				
ADVANCE SOLENOIDS				
080940 Actuator Std pkg 1		Servicing: Fiat, Renault - Visit our web catalogue for further information		
		Voltage: 12		
080941 Actuator Std pkg 1		Servicing: Ford - Visit our web catalogue for further information		
		Voltage: 12		
080942 Actuator Std pkg 1		Servicing: Renault - Visit our web catalogue for further information		
		Voltage: 12		
081117 Actuator Std pkg 1		Voltage: 12		
				

SOLENOID STOP

SOLENOID STOP		EL. SPECIFICATIONS	DIMENSIONS	ADDITIONAL SPECIFICATIONS
080177	Solenoid Stop Std pkg 1		Voltage: 12 Voltage 2: 12	Filter: w/o Insulated return: No
080178	Solenoid Stop Std pkg 1		Voltage: 24 Voltage 2: 24	Filter: w/o Insulated return: No
080207	Solenoid Stop Std pkg 1		Voltage: 12 Voltage 2: 12	Type: Stop solenoid Filter: w/o Insulated return: No
080208	Solenoid Stop Std pkg 1		Voltage: 24 Voltage 2: 24	Filter: w/o Insulated return: No
080209	Solenoid Stop Std pkg 1		Voltage: 12 Voltage 2: 12	Filter: w/o Insulated return: No
080210	Solenoid Stop Std pkg 1		Voltage: 24 Voltage 2: 24	Elect. connection: Plug Filter: w/o Insulated return: Yes
080211	Solenoid Stop Std pkg 1		Voltage: 24 Voltage 2: 24	Filter: w/o Insulated return: No

		EL. SPECIFICATIONS	DIMENSIONS	ADDITIONAL SPECIFICATIONS
080212	Solenoid Stop	Std pkg 1		
		Voltage: 12 Voltage 2: 12		Elect. connection: Plug Filter: w/o Insulated return: Yes
080595	Solenoid Stop	Std pkg 1		
		Voltage: 12 Voltage 2: 12		Filter: w/o Insulated return: No
080680	Solenoid Stop	Std pkg 1		
		Voltage: 12 Voltage 2: 12	Thread size: M5	Filter: w/
080873	Solenoid Stop	Std pkg 1		
		Voltage: 12 Voltage 2: 12		Filter: w/o
080926	Solenoid Stop	Std pkg 1		
		Voltage: 24 Voltage 2: 24		Plunger: Internal Mount. type: w/ nuts Filter: w/o
080929	Solenoid Stop	Std pkg 1		
		Voltage: 12 Voltage 2: 12		Elect. connection: Cable Filter: w/o Insulated return: Yes
080995	Solenoid Stop	Std pkg 1		
		Voltage: 12 Voltage 2: 12		Elect. connection: Multiplug Filter: w/o Insulated return: Yes

080996 Solenoid Stop Std pkg 1

 Voltage: 24
Voltage 2: 24

 Elect. connection: Multiplug
Filter: w/o
Insulated return: Yes

080998 Solenoid Stop Std pkg 1

 Voltage: 12
Voltage 2: 12

 Filter: w/o
Insulated return: No

081000 Solenoid Stop Std pkg 1

 Voltage: 12
Voltage 2: 12

 Function: Push
Type: Coil
Filter: w/o
Insulated return: No

081002 Solenoid Stop Std pkg 1

 Voltage: 24
Voltage 2: 24

 Elect. connection: Cable
Function: Push
Filter: w/o
Insulated return: Yes

081166 Solenoid Stop Std pkg 1

 Voltage: 12
Voltage 2: 12

 Plunger: Internal
Filter: w/o
Insulated return: No

PUMPS & PUMP PARTS

ELECTRICAL BILGE PUMPS

070154 Bilge Pump Std pkg 1

Model UP500. Completely submersible bilge pump. Compact design w/ ABS material housing, corrosion resistant. Shaft seal made of ceramic and graphite which ensures lubrication and leak resistance. Water inlet strainer slots will screen particles present in the bilge allowing easy running. Pump body can be dismantled by a simple snap-off movement for easy inspection and cleaning.

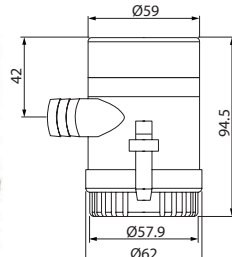
 Voltage: 12
Amp: 5

 Dim.: 94.5x59 mm
Hose connection:
19 mm
Lift height: 4 m
Capacity: 32 l/min
Pressure: 0.45 bar
Pressure: 6.5 PSI

 Gasket: Ceramic
Type: Bilge
Pump housing: ABS plastic
Pump shaft: Stainless steel
ISO norm: 8849/8846

070155 Bilge Pump Std pkg 1

Model UP1000. Completely submersible bilge pump. Compact design w/ ABS material housing, corrosion resistant. Shaft seal made of ceramic and graphite which ensures lubrication and leak resistance. Water inlet strainer slots will screen particles present in the bilge allowing easy running. Pump body can be dismantled by a simple snap-off movement for easy inspection and cleaning.



 Voltage: 12
Amp: 10

 Dim.: 124.7x78 mm
Hose connection:
28.6 mm
Lift height: 4 m
Capacity: 63 l/min
Pressure: 0.45 bar
Pressure: 6.5 PSI

 Gasket: Ceramic
Type: Bilge
Pump housing: ABS plastic
Pump shaft: Stainless steel
ISO norm: 8849/8846

070156 Bilge Pump Std pkg 1

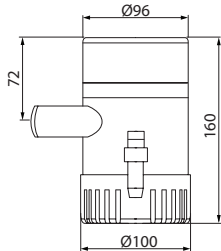
Model UP1500. Completely submersible bilge pump. Compact design w/ ABS material housing, corrosion resistant. Shaft seal made of ceramic and graphite which ensures lubrication and leak resistance. Water inlet strainer slots will screen particles present in the bilge allowing easy running. Pump body can be dismantled by a simple snap-off movement for easy inspection and cleaning.

 Voltage: 12
Amp: 20

 Dim.: 160x96 mm
Hose connection:
26.5 mm
Lift height: 4 m
Capacity: 95 l/min
Pressure: 0.45 bar
Pressure: 6.5 PSI

 Gasket: Ceramic
Type: Bilge
Pump housing: ABS plastic
Pump shaft: Stainless steel
ISO norm: 8849/8846

ACCESSORIES
070160 Automatic Float Switch Std pkg 1

Made of corrosion resistant materials.



 Voltage: 12/24
Amp: 10

 Dim.: 113x83x62 mm
Height/closed: 22
Height/open: 57

Floating switch: w/

ELECTRICAL WATER PUMPS
070144 Water Pump Std pkg 1 Servicing: Renault - Visit our web catalogue for further information

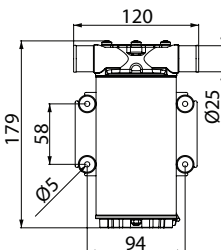
Model UP1-N. Self priming (1.5 m) electric water pump w/ self-lubricating flexible impeller for prolonged service life and better performance. Pump body made of brass w/ stainless steel shaft and a rubber lip seal. 1/2" BSP inner thread and ID 25 mm bore hose connections. Main application: as a bilge pump.



 Voltage: 12
Amp: 20

 Dim.: 176x120x94 mm
Hose connection:
25 mm
Capacity: 35 l/min
Pressure: 0.8 bar
Pressure: 11.6 PSI

 Type: Impeller
Pump housing: Brass
Pump shaft: Stainless steel
Impeller: Rubber
Filter: w/
Non return valve: Yes
ISO norm: 8849/8846

070145 Water Pump Std pkg 1

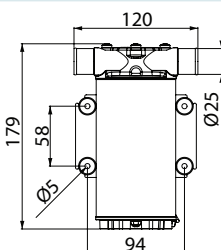
Model UP1-N. Self priming (1.5 m) electric water pump w/ self-lubricating flexible impeller for prolonged service life and better performance. Pump body made of brass w/ stainless steel shaft and a rubber lip seal. 1/2" BSP inner thread and ID 25 mm bore hose connections. Main application: as a bilge pump.



 Voltage: 24
Amp: 15

 Dim.: 176x120x94 mm
Hose connection:
25 mm
Capacity: 35 l/min
Pressure: 0.8 bar
Pressure: 11.6 PSI

 Type: Water, Impeller
Pump housing: Brass
Pump shaft: Stainless steel
Impeller: Rubber
Filter: w/
Non return valve: Yes
ISO norm: 8849/8846

070153 Water Pump Std pkg 1

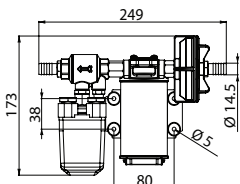
Model UP3/A. Self priming electric gear pump equipped w/ pressure switch, non-return valve to be used as automatic pump for water pressure system on boats, mobile homes etc. Bronze gears and rubber lip seal.



 Voltage: 12
Amp: 10

 Dim.: 163x249x118 mm
Hose connection:
13 mm
Capacity: 14 l/min
Pressure: 2 bar
Pressure: 29 PSI

 Type: Gear
Pump housing: Brass
Pump shaft: Stainless steel
Pinion: PTFE
Filter: w/
Non return valve: Yes

070172 Water Pump Std pkg 1

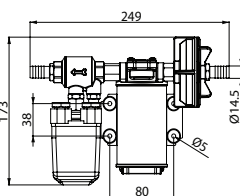
Model UP4/A. Self priming electric gear pump equipped w/ pressure switch, non-return valve to be used as automatic pump for water pressure system on boats, mobile homes etc. Bronze gears and rubber lip seal.

 Voltage: 24
Amp: 5

 Dim.: 163x249x118 mm
Hose connection:
14 mm
Capacity: 14 l/min
Pressure: 2 bar
Pressure: 29 PSI

 Type: Water, Gear
Pump housing: Brass
Pump shaft: Stainless steel
Pinion: PTFE
Filter: w/
Non return valve: Yes

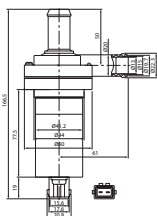
CIRCULATION TYPE
070192 Circulation Pump Std pkg 1 Servicing: Ford, Seat, VW - Visit our web catalogue for further information

Voltage: 12

 Hose connection:
20 mm
Capacity: 14 l/min

Type: Water, Impeller

070203 Circulation Pump Std pkg 1 Servicing: Saab, Scania, Ferrari, Maserati, Opel, Vauxhall - Visit our web catalogue for further information

Junior Timer Connector: HC-CARGO 192146. (see Workshop Cons. & Tools).

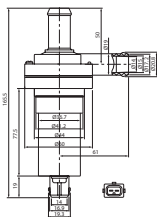

Voltage: 12

 Hose connection:
19 mm
Capacity: 18 l/min

 Type: Water, Impeller
Filter: w/

070206 Circulation Pump Std pkg 1 Servicing: Mercedes-Benz - Visit our web catalogue for further information



Voltage: 12

 Hose connection:
19 mm
Capacity: 18 l/min

 Type: Water, Impeller
Filter: w/o



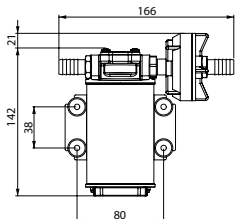



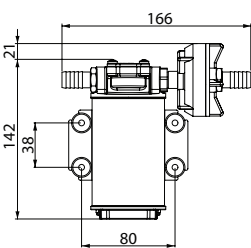

ELECTRICAL FLUID PUMPS
070147 Fluid Pump Std pkg 1 Servicing: Main application: transfer of diesel fuel, water antifreeze etc. - Visit our web catalogue for further information

Model UP1/3. self-priming 1.5 m. Electric pump w/ bronze gears for transfer of various liquids, complete w/ inline filter. Pump body made of brass w/ stainless steel shaft and a rubber lip seal. 3/8" BSP w/ brass connection for I.D. 14 mm inner tubing.

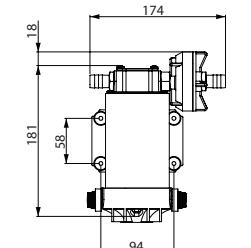
 Voltage: 12
Amp: 10

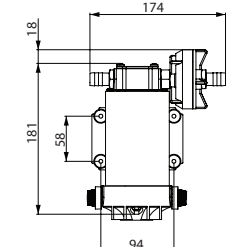
 Dim.: 163x166x95 mm
Hose connection:
14 mm
Capacity: 14 l/min
Pressure: 2 bar
Pressure: 29 PSI

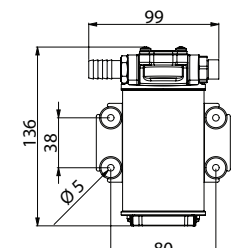
 Type: Gear
Pump housing: Brass
Pump shaft: Stainless steel
Pinion: Brass
Filter: w/

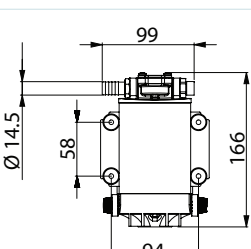
070148 Fluid Pump	Std pkg 1	Servicing: Main application: transfer of diesel fuel, water antifreeze etc. - Visit our web catalogue for further information	
Model UP/3. self-priming 1.5 m. Electric pump w/ bronze gears for transfer of various liquids, complete w/ inline filter. Pump body made of brass w/ stainless steel shaft and a rubber lip seal. 3/8" BSP w/ brass connection for I.D. 14 mm inner tubing.			
 	Voltage: 24 Amp: 5	Dim.: 163x166x95 mm Hose connection: 14 mm Capacity: 14 l/min Pressure: 2 bar Pressure: 29 PSI	Type: Gear Pump housing: Brass Pump shaft: Stainless steel Pinion: Brass Filter: w/
070149 Fluid Pump	Std pkg 1	Servicing: Main application: transfer of diesel fuel, water antifreeze etc. - Visit our web catalogue for further information	
Self-priming electric pump w/ helical bronze gears, complete w/ in-line filter. Nickel plated brass body w/ stainless steel shaft. Ports: 1/2" BSP w/ brass connection for Ø 16 mm inner tubing.			
 	Voltage: 12 Amp: 15	Dim.: 199x174x108 mm Hose connection: 16 mm Capacity: 26 l/min Pressure: 2 bar Pressure: 29 PSI	Type: Fluid, Gear Pump housing: Brass Pump shaft: Stainless steel Pinion: Brass Filter: w/
070150 Fluid Pump	Std pkg 1	Servicing: Main application: transfer of diesel fuel, water antifreeze etc. - Visit our web catalogue for further information	
Self-priming electric pump w/ helical bronze gears, complete w/ in-line filter. Nickel plated brass body w/ stainless steel shaft. Ports: 1/2" BSP w/ brass connection for Ø 16 mm inner tubing.			
 	Voltage: 24 Amp: 7.5	Dim.: 199x174x108 mm Hose connection: 16 mm Capacity: 26 l/min Pressure: 2 bar Pressure: 29 PSI	Type: Gear Pump housing: Brass Pump shaft: Stainless steel Pinion: Brass Filter: w/
070151 Fluid Pump	Std pkg 1	Servicing: Main application: transfer of diesel fuel, water antifreeze etc. - Visit our web catalogue for further information Model UP3/ oil. Self-priming 1 m. Electrical gear pump particularly suitable for the transfer of lubricating oils or viscous liquids. Complete w/ two brass connections for 14 mm inner tube and one additional quick-fit for 8 mm external tubing. The pump can be used for extracting lubricating oil out of oil sumps of engines. Pump body made of brass w/ bronze gears, stainless steel shaft and a rubber lip seal.	
 	Voltage: 12 Amp: 7.5	Dim.: 139x108x86 mm Hose connection: 14 mm Capacity: 5.5 l/min Pressure: 29 PSI	Gasket: Rubber Type: Fluid, Gear Pump housing: Brass Pump shaft: Stainless steel Pinion: Bronze Non return valve: Yes
070152 Fluid Pump	Std pkg 1	Servicing: Main application: transfer of diesel fuel, water antifreeze etc. - Visit our web catalogue for further information Model UP6/ oil. Self-priming 1.5 m. Electrical gear pump particularly suitable for the transfer of lubricating oils or viscous liquids. Professional model complete w/ two brass connections for 14 mm inner tube and one additional quick-fit for 8 mm external tubing. The pump can be used for extracting lubricating oil out of oil sumps of engines. Pump body made of brass w/ bronze gears, stainless steel shaft and a rubber lip seal.	
 	Voltage: 12 Amp: 10	Dim.: 166x117x94 mm Hose connection: 14 mm Capacity: 8 l/min Pressure: 2 bar Pressure: 29 PSI	Type: Fluid, Gear Pump housing: Brass Pump shaft: Stainless steel Pinion: Bronze

070173 Fluid Pump Std pkg 1

Model UP6 w/ oil. Self-priming 1.5 m. Electrical gear pump particularly suitable for the transfer of lubricating oils or viscous liquids. Professional model complete w/ two brass connections for 14 mm inner tube and one additional quick-fit for 8 mm external tubing. The pump can be used for extracting lubricating oil out of oil sumps of engines.

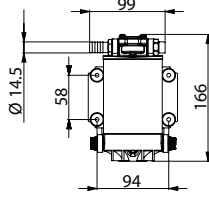

Voltage: 24
Amp: 7.5

Dim.: 166x117x94 mm
Hose connection: 14 mm
Capacity: 8 l/min
Pressure: 2 bar
Pressure: 29 PSI

Type: Fluid, Gear
Pump housing: Brass
Pump shaft: Stainless steel
Impeller: Rubber
Pinion: Bronze

070208 Electrical Fluid Pump HD Std pkg 1

Model UP12. Self-priming 4 m.

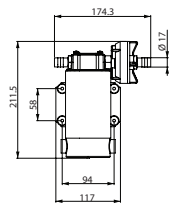

Voltage: 12
Amp: 30

Dim.: 212x174x109 mm
Hose connection: 16 mm
Capacity: 40 l/min
Pressure: 2.5 bar
Pressure: 36 PSI

Type: Fluid, Gear
Pump housing: Brass
Pump shaft: Stainless steel
Pinion: Bronze
Filter: w/
Non return valve: Yes

070209 Electrical Fluid Pump HD Std pkg 1

Model UP12. Self-priming 4 m.

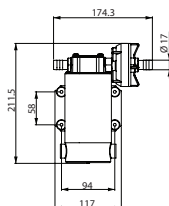

Voltage: 24
Amp: 15

Dim.: 212x174x109 mm
Hose connection: 16 mm
Capacity: 40 l/min
Pressure: 2.5 bar
Pressure: 36 PSI

Type: Fluid, Gear
Pump housing: Brass
Pump shaft: Stainless steel
Pinion: Bronze
Filter: w/
Non return valve: Yes

SPARE PARTS

070182 Brush Set Std pkg 1 Servicing: HC-CARGO 070144, -145, -149, -150, -152



Height: 18.1 mm
Thickness: 5.6 mm
Width: 8.6 mm

ELECTRICAL FUEL PUMPS

DIESEL PUMP KITS

070162 Diesel Transfer/Filter Kit Std pkg 1

Includes: 2.5 m suction hose. 2.5 m pressure hose w/ gun. Wired connection w/ alligator clips. Switch on the pump. Bypass valve on the pump ensures that it is not overloaded by closed gun. Not for gasoline.



Voltage: 12
Amp: 15

Dim.: 210x161x120 mm
Hose connection: 25 mm
Capacity: 45 l/min
Pressure: 1.2 bar
Pressure: 17.4 PSI

Type: Fluid, Gear
Impeller: Steel
Filter: w/

070175 Diesel Transfer/Filter Kit Std pkg 1

2.5 m suction hose w/ filter. 2.5 m pressure hose w/ gun. 2 m cable w/ alligator clips. Switch on the pump. Bypass valve on the pump ensure against overloading. Not for gasoline.

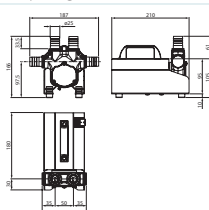

Voltage: 24
Amp: 7.5

Dim.: 210x161x120 mm
Hose connection: 25 mm
Capacity: 45.1 l/min
Pressure: 1.2 bar
Pressure: 17.4 PSI

Type: Fluid
Filter: w/

INTERRUPTER PUMPS
070003 Fuel Pump Std pkg 1

Built in Pressure Relief: assures an immediate return to zero pressure when the ignition is turned off. Prevents flooding and assures satisfactory restarting on the hottest days. Vertical mounting near tank is preferred. to 1.1 mtr. Fuel lift. Inlet/outlet 1/8"-27 thread. Fitting instruction. Fuel delivery capacity: 113.5 litre/h. Tested at: +60°C. Incl. 2 pcs. 6 mm hose nipples. 8 mm: HC-CARGO 080955. 8 mm angle: HC-CARGO 070181. Filter: HC-CARGO 070177.



Voltage: 12

 Capacity: 113.5 l/h
Pressure: 4-5 PSI

Type: Universal

070004 Fuel Pump Std pkg 1

Built in Pressure Relief: assures an immediate return to zero pressure when the ignition is turned off. Prevents flooding and assures satisfactory restarting on the hottest days. Vertical mounting near tank is preferred. to 1.1 mtr. Fuel lift. Inlet/outlet 1/8"-27 thread. Fitting instruction. Fuel delivery capacity: 113.5 litre/h. Tested at: +60°C. Incl. 2 pcs. Incl. 2 pcs. 6 mm hose nipples. 8 mm: HC-CARGO 080955. 8 mm angle: HC-CARGO 070181. Filter: HC-CARGO 070177.



Voltage: 24

 Capacity: 113.5 l/h
Pressure: 4-5 PSI

Type: Universal

070058 Fuel Pump Std pkg 1 Servicing: Thermo King, Carrier - Visit our web catalogue for further information

Built in Pressure Relief: assures an immediate return to zero pressure when the ignition is turned off. Prevents flooding and assures satisfactory restarting on the hottest days. Vertical mounting near tank is preferred. to 1.1 mtr. Fuel lift. Inlet/outlet 1/8"-27 thread. Fitting instruction. Fuel delivery capacity: 113.5 litre/h. Tested at: +60°C. Incl. 2 pcs. Incl. 2 pcs. 6 mm hose nipples. 8 mm: HC-CARGO 080955. 8 mm angle: HC-CARGO 070181. Filter: HC-CARGO 070177.



Voltage: 12

 Capacity: 87 l/h
Pressure: 7-9.5 PSI

Type: Universal

070134 Fuel Pump Std pkg 1 Servicing: New-Holland, Same - Visit our web catalogue for further information

Built in Pressure Relief: assures an immediate return to zero pressure when the ignition is turned off. Prevents flooding and assures satisfactory restarting on the hottest days. Vertical mounting near tank is preferred. to 1.1 mtr. Fuel lift. Inlet/outlet 1/8"-27 thread. Fitting instruction. Fuel delivery capacity: 113.5 litre/h. Tested at: +60°C. Filter: HC-CARGO 070177.



Voltage: 12

 Thread: In 1/4-18"
Capacity: 136 l/h
Pressure: 4-5 PSI

Type: Universal

070214 Fuel Pump Std pkg 1

w/ integral filter.



Voltage: 12

 Thread: 1/8-27 INT
Capacity: 150-227 l/h
Pressure: 9-11.5 PSI

 Fuel: Gasoline, diesel, ethanol,
methanol
Type: Universal

ACCESSORIES
070177 Filter Std pkg 1 Servicing: HC-CARGO 070003, 070004, 070058, 070134

PRESSURE PUMPS
070032 Fuel Pump Std pkg 1

Hose nipple 8 mm. Suction 1 mtr. Connectors can be rotated. Fitting instruction included.

Voltage: 12

Capacity: 120 l/h
Pressure: 0.2 bar

Fuel: Gasoline, diesel, ethanol, methanol
Type: Universal

070078 Fuel Pump Std pkg 1

Hose nipple 8 mm. Suction 1.5 mtr. Connectors can be rotated. Fitting instruction included.

Voltage: 12

Capacity: 125 l/h
Pressure: 0.35 bar

Type: Universal

070107 Fuel Pump Std pkg 1

Hose nipple 8 mm. Suction 1.5 mtr. Connectors can be rotated. Fitting instruction included.

Voltage: 24

Capacity: 130 l/h
Pressure: 0.35 bar

Fuel: Gasoline, diesel, ethanol, methanol
Type: Universal

070161 Fuel Pump Std pkg 1

Hose nipple 8 mm.

Voltage: 12

Capacity: 80-150 l/h
Pressure: 0.1-0.4 kg
Pressure: 1.4-5.7 PSI

Type: Universal

HIGH PERFORMANCE FUEL PUMPS
070187 Fuel Pump Std pkg 1

(Solid state pumps). Universal Built in Pressure Relief: assures an immediate return to zero pressure when the ignition is turned off. Prevents flooding and assures satisfactory restarting on the hottest days. For cars w/fuel-pressure. Not injection. To be mounted near the tank. The solid state pump is self priming to 30 cm. fuel lift. W/ electronic contacts. Fitting instruction included. Supplied w/ 2 pcs. 6 mm hose connection.

Voltage: 12

Thread: In 1/8"-27 NPTF
Capacity: 95 l/h
Pressure: 0.1-0.28 bar
Pressure: 0.1-0.3 kg
Pressure: 1.5-4 PSI

Fuel: Gasoline, diesel, ethanol, methanol
Type: Universal

070188 Fuel Pump Std pkg 1

(Solid state pumps). Universal. Built in Pressure Relief: assures an immediate return to zero pressure when the ignition is turned off. Prevents flooding and assures satisfactory restarting on the hottest days. For cars w/fuel-pressure. Not injection. To be mounted near the tank. The solid state pump is self priming to 30 cm. fuel lift. W/ electronic contacts. Fitting instruction included. Replaceable hose nipple. Supplied w/ 2 pcs. 6 mm hose connection.

Voltage: 12

Thread: In 1/8"-27 NPTF
Capacity: 132 l/h
Pressure: 0.3-0.5 kg
Pressure: 4-7 PSI

Fuel: Gasoline, diesel, ethanol, methanol
Type: Universal

070191 Fuel Pump Std pkg 1

(Solid state pumps). Universal. Built in Pressure Relief: assures an immediate return to zero pressure when the ignition is turned off. Prevents flooding and assures satisfactory restarting on the hottest days. For cars w/fuel-pressure. Not injection. To be mounted near the tank. The solid state pump is self priming to 30 cm. fuel lift. W/ electronic contacts. Fitting instruction included. Standard 6 mm hose nipples.



Voltage: 12

 Thread: In M8
 Capacity: 130 l/h
 Pressure: 0.5-0.7 kg
 Pressure: 7-10 PSI

 Fuel: Gasoline, diesel, ethanol, methanol
 Type: Universal

SOLID STATE PUMPS
070056 Fuel Pump Std pkg 1 Servicing: Caterpillar, IH/Case - Visit our web catalogue for further information

Built in Pressure Relief: assures an immediate return to zero pressure when the ignition is turned off. Prevents flooding and assures satisfactory restarting on the hottest days. Vertical mounting near tank is preferred. to 1.1 mtr. Fuel lift. Inlet/outlet 1/8"-27 thread. Fitting instruction. Fuel delivery capacity: 113.5 litre/h. Tested at: +60°C.



Voltage: 24

 Capacity: 121 l/h
 Pressure: 0.3-0.45 kg
 Pressure: 4.5-6 PSI

Type: Universal

070057 Fuel Pump Std pkg 1 Servicing: Thermo King etc - Visit our web catalogue for further information

Built in Pressure Relief: assures an immediate return to zero pressure when the ignition is turned off. Prevents flooding and assures satisfactory restarting on the hottest days. Vertical mounting near tank is preferred. to 1.1 mtr. Fuel lift. Inlet/outlet 1/8"-27 thread. Fitting instruction. Fuel delivery capacity: 113.5 litre/h. Tested at: +60°C.



Voltage: 12

 Capacity: 121 l/h
 Pressure: 0.7 kg
 Pressure: 10 PSI

 Fuel: Gasoline, diesel, ethanol, methanol
 Type: Universal

SUCTION PUMPS
070019 Fuel Pump Std pkg 1 Servicing: Bobcat - Visit our web catalogue for further information

Suction 0.2 bar = 2.7 mtr. Fitting instruction included.



Voltage: 12

 Thread: Out R-1/4"
 Capacity: 120 l/h
 Pressure: 0.2 bar

 Fuel: Gasoline
 Type: Universal

070021 Fuel Pump Std pkg 1 Servicing: VW - Visit our web catalogue for further information

Hose nipple 8 mm. Suction 1 mtr. Connectors can be rotated. Fitting instruction included.



Voltage: 12

 Capacity: 80 l/h
 Pressure: 0.15 bar

 Fuel: Gasoline/diesel
 Type: Universal

070184 Fuel Pump Std pkg 1 Servicing: VW marine - Visit our web catalogue for further information

Hose nipple 8 mm. Waterproof. Suction 1 mtr. Connectors can be rotated.



Voltage: 12

 Capacity: 120 l/h
 Pressure: 0.15 bar

 Fuel: Gasoline, diesel, ethanol, methanol
 Type: Universal

UNIVERSAL
HOSE NIPPLES

070067 Hose Nipple Std pkg 2				Hose ID: 10 mm Thread: R1/4	
070070 Hose Nipple Std pkg 2				Hose ID: 10 mm Thread: M16-1.5	
070077 Hose Nipple Std pkg 2				Hose ID: 6 mm Thread: 1/8-27 NPTF	
070181 Hose Nipple Std pkg 2 Servicing: HC-CARGO 070003, 070004, 070058 90°.				Hose ID: 8 mm Thread: R1/8	
080854 Hose Nipple Std pkg 5				Hose ID: 8 mm Thread: M14-1.5	
080855 Hose Nipple Std pkg 5				Hose ID: 10 mm Thread: R1/2	
080857 Hose Nipple Std pkg 5				Hose ID: 8 mm Thread: 1/2-20 UNF	
080858 Hose Nipple Std pkg 5				Hose ID: 8 mm Thread: M16-1.5	

		EL. SPECIFICATIONS	DIMENSIONS	ADDITIONAL SPECIFICATIONS
080875	Hose Nipple	Std pkg 5		
			Hose ID: 11 mm Thread: M16-1.5	
080954	Hose Nipple	Std pkg 2		
			Hose ID: 6 mm Thread: M14-1.5	
080955	Hose Nipple	Std pkg 2	Servicing: HC-CARGO 070003, 070004, 070058	
			Hose ID: 8 mm Thread: 1/8-27 NPTF	
080958	Hose Nipple	Std pkg 5		
			Hose ID: 10 mm Thread: M18-1.5	
080959	Hose Nipple	Std pkg 5		
			Hose ID: 10 mm Thread: M14-1.5	
080960	Hose Nipple	Std pkg 5		
			Hose ID: 10 mm Thread: 1/2-20 UNF	
081039	Nipple	Std pkg 10	Servicing: Bosch - Visit our web catalogue for further information	
				
081040	Nipple	Std pkg 10	Servicing: Bosch - Visit our web catalogue for further information	
				

FUEL INJECTION PUMPS

070053 Fuel Injection Pump

Std pkg 1

Servicing: Abarth, Alfa Romeo, Austin, BMW, Citroen, Fiat, Jaguar, Lancia, Land Rover, Mercedes-Benz, Opel, Peugeot, Pininfarina - Visit our web catalogue for further information



Voltage: 12

Pressure: 2-3.5 bar

070054 Fuel Injection Pump

Std pkg 1

Servicing: Alfa Romeo, Citroen, Fiat, Jaguar, Mercedes-Benz, Peugeot, Porsche, Renault, Saab, Volvo - Visit our web catalogue for further information



Voltage: 12

Pressure: 4 bar

070055 Fuel Injection Pump

Std pkg 1

Servicing: Ford, Mercedes-Benz - Visit our web catalogue for further information



Voltage: 12

Pressure: 3 bar

FILTERS & FILTER PARTS

FUEL FILTERS

090193 Filter House

Std pkg 1

90 l/hour. Glass Bowl: HC-CARGO 090073. Filter Cup: HC-CARGO 090127.



Thread: M14-1.5

Water separator: Yes

090194 Filter House

Std pkg 1



Thread: 1/2"-20 UNF

Water separator: Yes

090203 Filter House

Std pkg 1







Servicing: Ford Fiesta, Mondeo, Transit - Visit our web catalogue for further information

150 l/hour.

 Hose nipple: 8 mm
Thread: M14-1.5

 Hand pump: Yes
Water separator: Yes

		EL. SPECIFICATIONS	DIMENSIONS	ADDITIONAL SPECIFICATIONS
090213 Filter House		Std pkg 1		
<i>Flow 150 l/h. Glass Bowl: HC-CARGO 090074.</i>				
			Thread: M14-1.5	Fuel: Diesel Water separator: Yes
090345 Filter Kit		Std pkg 1		
<i>Filter Top: HC-CARGO 090319.</i>				
			Thread: M14-1.15	
090346 Filter Kit		Std pkg 1		
<i>Filter Top: HC-CARGO 090320.</i>				
			Thread: 1/2-20UNF	
090404 Filter House		Std pkg 1		
<i>Glass Bowl: HC-CARGO 090074.</i>				
			Thread: 1/2"-20	Water separator: Yes
AS301 Fuel Filter		Std pkg 1	Servicing: Alfa Romeo, Audi, Citroen, Fiat, Ford, Land Rover, Peugeot, Renault, Seat, Volvo - Visit our web catalogue for further information	
				Fuel: Diesel
RT1000 Fuel Filter		Std pkg 12		
			ID/hose: 6 mm ID/hose 2: 8 mm	Fuel: Gasoline Universal: Yes Transparent: Yes
RT1003 Fuel Filter		Std pkg 24		
			ID/hose: 6 mm ID/hose 2: 8 mm	Fuel: Gasoline Universal: Yes Transparent: Yes

		EL. SPECIFICATIONS	DIMENSIONS	ADDITIONAL SPECIFICATIONS
RT1005	Fuel Filter	Std pkg 12		
			ID/hose: 6 mm ID/hose 2: 6 mm	Fuel: Gasoline Universal: Yes Transparent: Yes
RT2002	Fuel Filter	Std pkg 24	Servicing: Mercedes-Benz - Visit our web catalogue for further information	
<i>Only for diesel fuel.</i>				
			ID/hose: 6 mm ID/hose 2: 8 mm	Fuel: Diesel Universal: Yes Transparent: Yes
RT2006	Fuel Filter	Std pkg 6		
<i>281 micron.</i>				
			ID/hose: 6 mm ID/hose 2: 8 mm	Fuel: Diesel Universal: Yes Transparent: Yes
RT2016	Fuel Filter	Std pkg 12	Servicing: Seat, Peugeot, VW, Volvo, Vauxhall, Peugeot, Seat, Vauxhall, Volvo, VW - Visit our web catalogue for further information	
			ID/hose: 6 mm ID/hose 2: 8 mm	Fuel: Diesel Universal: Yes Transparent: Yes
FUEL HEATERS				
080944	Heat Exchanger	Std pkg 1		
			Thread: M16-1.5	Type: Water Sandwich type: Yes
081176	Fuel Heater	Std pkg 1		
		Voltage: 12 Watt: 150	Demister tube connection: 8/10 mm	Type: Electric Sandwich type: No
WATER SEPARATOR				
090145	Water Separator	Std pkg 1		
			Thread: M14-1.5	Universal: Yes

		EL. SPECIFICATIONS	DIMENSIONS	ADDITIONAL SPECIFICATIONS
090146 Water Separator		Std pkg 1		
			Thread: 1/2"-20 UNF	Universal: Yes
SPARE PARTS				
080194 O-ring		Std pkg 10		
			ID: 6 mm Thickness: 2 mm	Material: Rubber
080465 Gasket		Std pkg 10	Servicing: CAV - Visit our web catalogue for further information	
			ID: 15 mm OD: 28 mm Thickness: 3 mm	
080701 Gasket		Std pkg 10	Servicing: CAV - Visit our web catalogue for further information	
For filter glass.				
			ID: 80 mm OD: 88 mm Thickness: 3 mm	
080702 Gasket		Std pkg 10	Servicing: CAV - Visit our web catalogue for further information	
For filter glass.				
			ID: 77 mm OD: 84 mm Thickness: 3 mm	
080805 Gasket		Std pkg 10	Servicing: CAV - Visit our web catalogue for further information	
For filter glass.				
			ID: 41.5 mm OD: 54 mm Thickness: 3 mm	
081007 Gasket Kit		Std pkg 1	Servicing: CAV - Visit our web catalogue for further information	
				

EL. SPECIFICATIONS		DIMENSIONS	ADDITIONAL SPECIFICATIONS
090071	Single Cover Std pkg 1		Thread: M14-1.5 Universal: Yes
			
090072	Single Cover Std pkg 1		Thread: 1/2"-20 UNF Universal: Yes
			
090073	Glass Bowl Std pkg 1	Servicing: HC-CARGO 090193	
			
090127	Filter Cup Std pkg 1	Servicing: HC-CARGO 090193	
			
090166	Filter Cover Std pkg 1		Thread: M14-1.5 Hand pump: Yes
<i>Filter thread 16x1.5 mm.</i> 			
090167	Filter Cover Std pkg 1	Servicing: Bosch, VW, GM - Visit our web catalogue for further information	
<i>Filter thread 16x1.5 mm.</i> 			Thread: M14-1.5 Hand pump: Yes Universal: Yes
090172	Glass Std pkg 1		
<i>For water separator.</i> 			

EL. SPECIFICATIONS		DIMENSIONS	ADDITIONAL SPECIFICATIONS
090316 Filter Top Std pkg 1			
		Thread: M14-1.5	Hand pump: Yes Universal: Yes
090319 Filter Top Std pkg 1 Servicing: HC-CARGO 090345			
		Thread: M14-1.5	
090320 Filter Top Std pkg 1 Servicing: HC-CARGO 090346			
		Thread: 1/2"-20 UNF	
090347 Filter Top Std pkg 1 Servicing: Japanese appl - Visit our web catalogue for further information			
8 mm hose I.D.			
		Thread: 20x1.5	Hand pump: Yes Universal: Yes
090381 Filter Top Std pkg 1			
Filter thread 16x1.5 mm.			
		Thread: 14x1.5	Universal: Yes
DIESEL PARTS			
BEARINGS			
090061 Repair Kit Std pkg 1			
			
DIESEL PUMP PARTS			
080038 Air Screw Std pkg 1 Servicing: DPA - Visit our web catalogue for further information			
			

		EL. SPECIFICATIONS	DIMENSIONS	ADDITIONAL SPECIFICATIONS
080114	Hollow Screw	Std pkg 1		
			Thread: M12-1.5 Hole size: 5.5 mm	Calibrated: Yes
080614	Rotor Vane Set	Std pkg 1	Servicing: CAV DPA/DPC - Visit our web catalogue for further information	
				
080752	Diaphragm	Std pkg 1	Servicing: DPC - Visit our web catalogue for further information	
				
080757	Diaphragm	Std pkg 1	Servicing: DPS - Visit our web catalogue for further information	
				
080773	Rotor Vane Set	Std pkg 1	Servicing: DPA - Visit our web catalogue for further information	
				
080815	Liner	Std pkg 1	Servicing: CAV DPA - Visit our web catalogue for further information	
				
080824	Rotor Vane Set	Std pkg 1		
				

			EL. SPECIFICATIONS	DIMENSIONS	ADDITIONAL SPECIFICATIONS
080969	Diaphragm	Std pkg 1	Servicing: DPC - Visit our web catalogue for further information		
<i>Diaphragm set for boost controller.</i>					
					
081004	Injector Nut	Std pkg 1	Servicing: Volvo Penta - Visit our web catalogue for further information		
					
090027	Repair Kit	Std pkg 1	Servicing: Bosch PE6P - Visit our web catalogue for further information		
					
090047	Repair Kit	Std pkg 1	Servicing: CAV DPA pumps - Visit our web catalogue for further information		
					
090055	Gasket Kit	Std pkg 1	Servicing: CAV DPS - Visit our web catalogue for further information		
					
090062	Damper	Std pkg 1	Servicing: Bosch - Visit our web catalogue for further information		
					
090136	Gasket Kit	Std pkg 1	Servicing: CAV DPC "Turbo" - Visit our web catalogue for further information		
					

090150 End Plate Std pkg 1



090222 Gasket Kit Std pkg 1 Servicing: Simms Minimec 4 cyl, CAV - Visit our web catalogue for further information

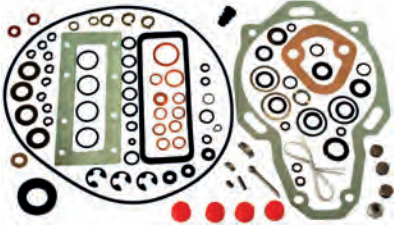

090223 Gasket Kit Std pkg 1

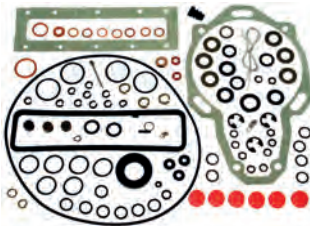

090242 Gasket Kit Std pkg 1 Servicing: Stanadyne DB2 - Visit our web catalogue for further information



090244 Governor Kit Std pkg 1 Servicing: CAV Minimec - Visit our web catalogue for further information













090277 Start Advance Std pkg 1 Servicing: Talbot - Visit our web catalogue for further information



090278 Start Advance Std pkg 1 Servicing: Citroen, Peugeot - Visit our web catalogue for further information



		EL. SPECIFICATIONS	DIMENSIONS	ADDITIONAL SPECIFICATIONS
090294	Gasket Kit	Std pkg 1	Servicing: CAV Epic, Lucas Epic - Visit our web catalogue for further information	
				
090344	Gasket Kit	Std pkg 1	Servicing: Stanadyne DB4 - Visit our web catalogue for further information	
				
090441	Gasket Kit	Std pkg 1	Servicing: VW. - Visit our web catalogue for further information	
<i>Repair kit for VW injector pumps. Incl. Parts for 1 injectors.</i>				
				
FEED PUMPS				
090015	Feed Pump	Std pkg 1		Type: Plunger Valves: 2
				
090016	Feed Pump	Std pkg 1		Type: Plunger No./mounting holes: 2 Valves: 2
				
090020	Feed Pump	Std pkg 1		Type: Plunger Valves: 2
				
090151	Feed Pump	Std pkg 1	Servicing: Hatz - Visit our web catalogue for further information	
				

		EL. SPECIFICATIONS	DIMENSIONS	ADDITIONAL SPECIFICATIONS
090156	Feed Pump	Std pkg 1	Servicing: Cummins, DAF, I.H - Visit our web catalogue for further information	Type: Diaphragm
				
090187	Feed Pump	Std pkg 1	Servicing: Fiat, Iveco, New Holland - Visit our web catalogue for further information	Type: Diaphragm
				
090197	Feed Pump	Std pkg 1	Servicing: Ford Transit 2.5 L - Visit our web catalogue for further information	Type: Diaphragm
				
090198	Feed Pump	Std pkg 1		Type: Plunger
				
090202	Feed Pump	Std pkg 1		Type: Plunger
				
090235	Feed Pump	Std pkg 1	Servicing: Vetus, Volvo Penta - Visit our web catalogue for further information	Type: Diaphragm No./mounting holes: 2
			Mount. hole dist.: 44.5 mm Thread type/inlet: M12x1 Thread type/outlet: M12x1	
090250	Feed Pump	Std pkg 1	Servicing: Cummins - Visit our web catalogue for further information	Type: Diaphragm
				

		EL. SPECIFICATIONS	DIMENSIONS	ADDITIONAL SPECIFICATIONS
090251	Feed Pump	Std pkg 1	Servicing: Cummins - Visit our web catalogue for further information	
				Type: Plunger
090253	Feed Pump	Std pkg 1	Servicing: Kubota Industry - Visit our web catalogue for further information	
				Type: Diaphragm
090254	Feed Pump	Std pkg 1		
				Type: Diaphragm
090314	Feed Pump	Std pkg 1		
				Type: Diaphragm
090315	Feed Pump	Std pkg 1		
				Type: Plunger
090333	Feed Pump	Std pkg 1		
				Type: Diaphragm
090337	Feed Pump	Std pkg 1		
				Type: Diaphragm

090391 Feed Pump Std pkg 1 Servicing: Cummins - Visit our web catalogue for further information



090440 Feed Pump Std pkg 1 Servicing: Thermo King and Carrier - Visit our web catalogue for further information

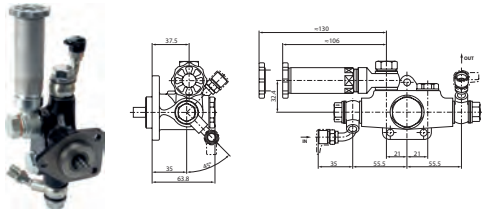

Type: Zexel

SPARE PARTS

080059 Valve Repair Kit Std pkg 1

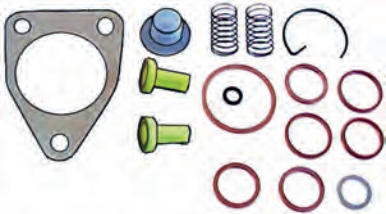

080064 Valve Repair Kit Std pkg 1



080071 Hand Pump Std pkg 1

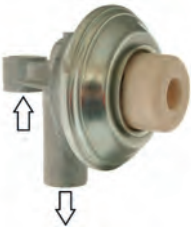

Thread: M14-1.5
Inlet size: 14

Type: Universal

080097 Oil Seal Std pkg 10 Servicing: VE pumps - Visit our web catalogue for further information



ID: 20 mm
OD: 31.1 mm
Height: 6.9 mm

080099 Gasket Std pkg 10 Servicing: HC-CARGO 080730, Bosch VE



Type: Diesel
Material: Viton

080168 Repair Kit Std pkg 1

Bushing lenght: 40.5 mm.



080170 Repair Kit Std pkg 1 Servicing: HC-CARGO 080730, 0460494251

Bushing lenght: 30.5 mm.



080205 Gasket Std pkg 10 Servicing: CAV - Visit our web catalogue for further information

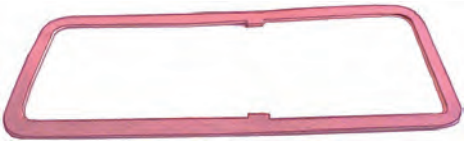

080292 Glass Bowl Std pkg 5 Servicing: Bosch - Visit our web catalogue for further information

For filter glass.



080294 Repair Kit Std pkg 1

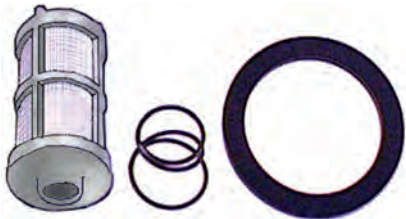

080295 Hand Pump Std pkg 1



Thread: M16-1.5

080695 Hand Pump Std pkg 1

Union: HC-CARGO 081003.



Thread: M22-1

080703 Hand Pump Std pkg 1

For hose I.D. 8 mm.



Type: Universal

080730 Repair Kit Std pkg 1

Contains: 1x HC-CARGO 080170. 1x HC-CARGO 080099.

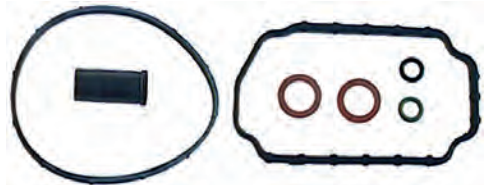

080738 Gasket Std pkg 10



080742 Hand Pump Std pkg 1



Thread: M16-1.5

080783 Repair Kit Std pkg 1

Servicing: CAV - Visit our web catalogue for further information



080793 Hand Pump Std pkg 1

Servicing: Scania - Visit our web catalogue for further information



Thread: M14-1.5

Type: Universal

080811 Repair Kit Std pkg 1

Servicing: Bosch - Visit our web catalogue for further information



		EL. SPECIFICATIONS	DIMENSIONS	ADDITIONAL SPECIFICATIONS
080840	Hand Pump	Std pkg 1		
			Thread: M16-1.5	Material: Steel
080852	Repair Kit	Std pkg 1	Servicing: Bosch - Visit our web catalogue for further information	
				
080933	Gasket	Std pkg 10	Servicing: CAV DPA - Visit our web catalogue for further information	
				Material: Cardboard
081003	Union	Std pkg 1	Servicing: HC-CARGO 080695	
			Thread: M16-1.5-M22-1	
081058	Hot Starting Device	Std pkg 1	Servicing: VE-EDC pumps for Audi, BMW, Seat, Skoda, VW - Visit our web catalogue for further information	
				
090076	Prefilter	Std pkg 1		
			Thread: M14-1.5	Fuel: Diesel Filter type: Prefilter
090159	Hand Pump	Std pkg 1		
			Thread: 1/2"-20 UNF Inlet size: 14	Type: Universal

FILTER PARTS

080721 Plug Std pkg 10



080809 Plug Std pkg 5 Servicing: CAV - Visit our web catalogue for further information



090074 Glass Bowl Std pkg 1 Servicing: HC-CARGO 090213, 090404, CAV

GOVERNOR PARTS

090147 Diesel Injection Pump Std pkg 1 Servicing: Bosch RSV Turbo - Visit our web catalogue for further information

INJECTION PIPE HOLDERS

080046 Injection Pipe Holder Std pkg 10

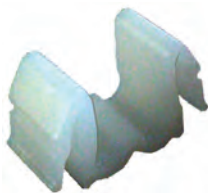

 Material: Plastic
No./pipes: 2

080047 Injection Pipe Holder Std pkg 10

 Material: Plastic
No./pipes: 3

INJECTION PIPES

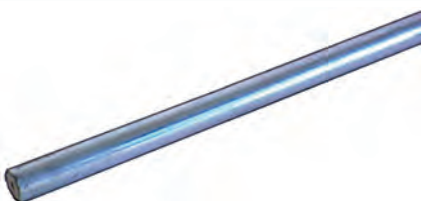





090086 Injection Pipe Std pkg 1

 ID: 1.5 mm
OD: 6 mm
Length: 3000 mm

Universal: Yes

EL. SPECIFICATIONS		DIMENSIONS	ADDITIONAL SPECIFICATIONS
090087 Injection Pipe Std pkg 1			
		ID: 2 mm OD: 6 mm Length: 3000 mm	Universal: Yes
NOZZLES			
100352 Nozzle Std pkg 1		Servicing: Mercedes-Benz - Visit our web catalogue for further information	
			Code type: DN0SD265 Nozzle type: Diesel
NOZZLE HOLDER PARTS			
080055 Inj. Pipe Nut Set Std pkg 10			
		OD: 6 mm	
080340 Injector Spacer Std pkg 1		Servicing: Bosch, kbal, kdal - Visit our web catalogue for further information	
			
080389 Injector Washer Std pkg 10			
		ID: 12.1 mm OD: 23 mm Thickness: 1 mm	Overflow washers: Copper
080457 Injector Washer Std pkg 10		Servicing: Mitsubishi, Nissan, Toyota, mm - Visit our web catalogue for further information	
		ID: 12 mm OD: 18.5 mm Thickness: 1 mm	Overflow washers: Aluminium
080458 Injector Washer Std pkg 10			
		ID: 12.5 mm OD: 22.5 mm Thickness: 1 mm	Overflow washers: Aluminium

		EL. SPECIFICATIONS	DIMENSIONS	ADDITIONAL SPECIFICATIONS
080459	Injector Washer	Std pkg 10		
			ID: 12 mm OD: 19.5 mm Thickness: 1 mm	Overflow washers: Copper
080467	Plug	Std pkg 50	Servicing: Bosch - Mercedes - Visit our web catalogue for further information	
				
080582	Eye Union Overflow	Std pkg 5		
<i>Spanner size 24 mm.</i>				
				Overflow washers: Brass No./nipples: 1
081041	Overflow Kit	Std pkg 1		
<i>Hose 100 cm.</i>				
				No./nipples: 4
081129	Injector Seal Kit	Std pkg 4	Servicing: Opel - Visit our web catalogue for further information	
				
SEALING RINGS				
080865	Sealing Ring	Std pkg 50		
			ID: 8 mm OD: 16 mm Thickness: 1 mm	Material: Steel/rubber
080866	Sealing Ring	Std pkg 50		
			ID: 10 mm OD: 18 mm Thickness: 1.5 mm	Material: Steel/rubber

		EL. SPECIFICATIONS	DIMENSIONS	ADDITIONAL SPECIFICATIONS
080868	Sealing Ring	Std pkg 50		
			ID: 14.7 mm OD: 21 mm Thickness: 1.5 mm	Material: Steel/rubber
VE PUMP PARTS				
090092	Repair Kit	Std pkg 1	Servicing: Bosch VE - Visit our web catalogue for further information	
Turbo.				
				
090165	Gasket Kit	Std pkg 1	Servicing: Bosch VE - Visit our web catalogue for further information	
				
090212	Gasket Kit	Std pkg 1	Servicing: Bosch VE - Visit our web catalogue for further information	
				
VE THROTTLE SHAFTS				
080188	Throttle Shaft	Std pkg 1	Servicing: CAV DPA - Visit our web catalogue for further information	
				Type/throttle shaft: Short
080828	Throttle Shaft	Std pkg 1	Servicing: Opel, Ford, VW - Visit our web catalogue for further information	
			Total length: 59.5 mm Total height: 47.2 mm Bottom o-ring: 26.7 mm Top o-ring: 3 mm	
SPARE PARTS				
080420	O-ring	Std pkg 10		
For throttle shafts.				
			ID: 6.5 mm Thickness: 2 mm	

GLOW PLUGS

HC-CARGO	Std. Pkg.	Voltage/ glow plug	Voltage/ battery	Ampere	Thread	L1	L2	L3	Glow duration
100079	Pkg.1	0.9	12	6.3	M18-1.5	27.5 mm	32.5 mm	90 mm	
100652	Pkg.1	4.4	12	8.5	M8-1	26.5 mm	100 mm	147.9 mm	4 sec.
100673	Pkg.1	4.4	12	8.5	M10-1	27 mm	81 mm	129.4 mm	4 sec.
100625	Pkg.1	4.4	12	8.5	M8-1	29.5 mm	70 mm	116.5 mm	4 sec.
100660	Pkg.1	4.4	12	8.5	M8-1	29 mm	42 mm	93.9 mm	4 sec.
100245	Pkg.1	5	12	11	M10-1.25	24 mm	47 mm	89 mm	20 sec.
100624	Pkg.1	5	12	8.5	M10x1	29 mm	46 mm	97 mm	4 sec.
100641	Pkg.1	5	12	8.5	M10-1	32 mm	46 mm	106 mm	4 sec.
100277	Pkg.1	6	12	8	M10-1.25	31.5 mm	43.5 mm	95 mm	12 sec.
100254	Pkg.1	6.5	12	6.5	M10-1.25	19 mm	33.5 mm	70 mm	20 sec.
100324	Pkg.1	6.5	12	5.5	M10-1.25	21.5 mm	47 mm	84 mm	15 sec.
100325	Pkg.1	6.5	12	5.5		21.5 mm	90 mm		20 sec.
100676	Pkg.1	7	12	10	M10X1	25.5 mm	115.5 mm	163.4 mm	4 sec.
100683	Pkg.1	7	12	10	M8X1	25.5 mm	78 mm	125.9 mm	4 sec.
100680	Pkg.1	7	12	10	M8X1	26 mm	100 mm	147.4 mm	4 sec.
100665	Pkg.1	7	12	10	M8x1	27.5 mm	85 mm	135 mm	4 sec.
100678	Pkg.1	7	12	10	M10X1	27 mm	81 mm	131 mm	4 sec.
100681	Pkg.1	7	12	10	M10X1	28 mm	46 mm	95.9 mm	4 sec.
100257	Pkg.1	7	12	8.5	M10-1.25	28 mm	53 mm	101 mm	20 sec.
100679	Pkg.1	7	12	10	M10X1	28 mm	78 mm	134 mm	4 sec.
100682	Pkg.1	7	12	10	M8X1	29.5 mm	70 mm	116.5 mm	4 sec.
100258	Pkg.1	7	12	8	M10-1.25	31.5 mm	43 mm	95 mm	20 sec.
100286	Pkg.1	8.5	12	9	M10-1.25	22 mm	45 mm	86 mm	20 sec.
100256	Pkg.1	8.5	12	9	M10-1.25	28 mm	53 mm	101 mm	20 sec.
100295	Pkg.1	9	12	10	M18-1.5	28 mm	35 mm	78.4 mm	20 sec.
100566	Pkg.1	9.5	12	10	M14-2	30 mm	52.5 mm	97.9 mm	20 sec.
100522	Pkg.1	10	12	10	M10-1.25	17 mm	34.5 mm	68 mm	6 sec.
100565	Pkg.1	10	12	10	M10-1	24.5 mm	54.5 mm	96 mm	10 sec.
100636	Pkg.1	10.5	12	9.7		24.3 mm	76.5 mm		9 sec.
100262	Pkg.1	10.5	12	10	M18-1.5	25 mm	47.5 mm	87.9 mm	20 sec.
100583	Pkg.1	10.5	12	14		25 mm	87.9 mm		20 sec.
100548	Pkg.1	10.5	12	10	M10-1	28.5 mm	27.3 mm	77.3 mm	
100684	Pkg.1	11		10	M10X1	24 mm	44.5 mm	90.5 mm	8 sec.
100685	Pkg.1	11		8.5	M10x1	24 mm	51 mm	96.4 mm	
100691	Pkg.1	11		10	M10x1	24 mm	61 mm	107 mm	8 sec.
100686	Pkg.1	11		8.5	M8x1	27.5 mm	63 mm	113.9 mm	
100690	Pkg.1	11		8.5	M9x1	27.5 mm	70 mm	119 mm	
100689	Pkg.1	11		10	M10x1.25	28.5 mm	111 mm	160 mm	8 sec.
100687	Pkg.1	11		5	M10x1.25	29 mm	82.5 mm	129 mm	3-7 sec.
100688	Pkg.1	11		10	M10x1	30 mm	57 mm	109 mm	8 sec.
100692	Pkg.1	11		10	M10x1.25	31 mm	108.5 mm	160.9 mm	4.5 sec.
100653	Pkg.1	11	12	10	M10x1.25	145 mm	181.5 mm	21 mm	8 sec.
100336	Pkg.1	11	12	10	M10-1.25	15.5 mm	52 mm	81.5 mm	10 sec.
100435	Pkg.1	11	12	6.5	M10-1.25	16 mm	37.5 mm	75 mm	25 sec.
100434	Pkg.1	11	12	8	M10-1.25	16 mm	39 mm	75 mm	20 sec.
100531	Pkg.1	11	12	10	M12-1.25	17.5 mm	30 mm	62.9 mm	8 sec.
100510	Pkg.1	11	12	7	M10-1.25	17.5 mm	47 mm	85 mm	7 sec.
100557	Pkg.1	11	12	10	M10-1.25	17.5 mm	47 mm	85 mm	7 sec.
100513	Pkg.1	11	12	7	M10-1.25	17.5 mm	53 mm	89 mm	7 sec.
100271	Pkg.1	11	12	10	M10-1.25	17 mm	33.5 mm	67 mm	10 sec.
100433	Pkg.1	11	12	7.5	M10-1.25	17 mm	33.5 mm	70 mm	20 sec.
100426	Pkg.1	11	12	7.2	M10-1.25	17 mm	47 mm	84 mm	15 sec.
100668	Pkg.1	11	12	10	M10-1.25	17 mm	50 mm	82.4 mm	8 sec.
100670	Pkg.1	11	12	10	M10-1.25	18.5 mm	47.5 mm	81.4 mm	8 sec.
100302	Pkg.1	11	12	7	M10-1.25	18.5 mm	47 mm	83 mm	7 sec.
100326	Pkg.1	11	12	10	M10-1.25	18.5 mm	62 mm	95 mm	9 sec.
100518	Pkg.1	11	12	7.3	M8-1	19.5 mm	34 mm	69 mm	7 sec.
100247	Pkg.1	11	12	9	M10-1.25	19 mm	33.5 mm	70 mm	20 sec.
100251	Pkg.1	11	12	8	M10-1.25	19 mm	33.5 mm	70 mm	20 sec.

HC-CARGO	Std. Pkg.	Voltage/ glow plug	Voltage/ battery	Ampere	Thread	L1	L2	L3	Glow duration
100666	Pkg.1	11	12	10	M10-1.25	19 mm	50 mm	84.4 mm	8 sec.
100306	Pkg.1	11	12	10	M10-1.25	19 mm	50 mm	84.4 mm	8 sec.
100559	Pkg.1	11	12	10	M10-1.25	20.5 mm	47 mm	88 mm	5 sec.
100512	Pkg.1	11	12	10	M12-1.25	20 mm	26 mm	61.4 mm	8 sec.
100639	Pkg.1	11	12	10	M12-1.25	20 mm	30 mm	79.5 mm	8 sec.
100303	Pkg.1	11	12	8	M12-1.25	20 mm	32 mm	66.9 mm	8 sec.
100563	Pkg.1	11	12	12	M10-1.25	21.5 mm	47 mm	89 mm	7 sec.
100560	Pkg.1	11	12	10	M10-1.25	21 mm	140.5 mm	180 mm	5 sec.
100520	Pkg.1	11	12	6.5	M10-1.25	22.5 mm	47 mm	85 mm	5 sec.
100619	Pkg.1	11	12	10	M10-1.25	22 mm	45.5 mm	82.9 mm	8 sec.
100521	Pkg.1	11	12	9.7	M10-1.25	22 mm	45 mm	83.5 mm	9 sec.
100515	Pkg.1	11	12	6	M10-1.25	22 mm	45 mm	84 mm	8.5 sec.
100634	Pkg.1	11	12	7	M10-1.25	22 mm	45 mm	85 mm	20 sec.
100261	Pkg.1	11	12	16.5	M10-1.25	22 mm	45 mm	86 mm	15 sec.
100287	Pkg.1	11	12	10	M10-1.25	22 mm	50 mm	88 mm	10 sec.
100555	Pkg.1	11	12	10	M10-1.25	23.5 mm	93 mm	143 mm	10 sec.
100578	Pkg.1	11	12	10	M10-1.25	23 mm	175.5 mm	213 mm	7 sec.
100650	Pkg.1	11	12	10	M12-1.25	24.5 mm	32 mm	71.9 mm	8 sec.
100532	Pkg.1	11	12	10	M10-1	24.5 mm	53 mm	92.9 mm	8 sec.
100622	Pkg.1	11	12	10	M8-1	24.5 mm	80 mm	125.9 mm	4.5 sec.
100646	Pkg.1	11	12	10	M10-1	24 mm	105 mm	151 mm	8 sec.
100323	Pkg.1	11	12	10	M10-1	24 mm	46 mm	85.4 mm	8 sec.
100529	Pkg.1	11	12	10	M10-1	24 mm	46 mm	85.4 mm	8 sec.
100436	Pkg.1	11	12	10	M10-1	24 mm	46 mm	92 mm	8 sec.
100275	Pkg.1	11	12	6.5	M10-1.25	24 mm	47 mm	89 mm	25 sec.
100292	Pkg.1	11	12	6	M10-1.25	24 mm	47 mm	89 mm	10 sec.
100592	Pkg.1	11	12	8.6	M10-1	24 mm	53 mm	98.5 mm	10 sec.
100645	Pkg.1	11	12	10	M10-1	24 mm	57 mm	103 mm	8 sec.
100534	Pkg.1	11	12	10	M10-1	24 mm	57 mm	96.4 mm	8 sec.
100662	Pkg.1	11	12	10	M10-1.25	24 mm	93 mm	132.4 mm	8 sec.
100657	Pkg.1	11	12	10	M12-1.25	24 mm	96 mm	135.4 mm	8 sec.
100432	Pkg.1	11	12	10	M12-1.25	25 mm	27 mm	67.4 mm	8 sec.
100541	Pkg.1	11	12	10	M12-1.25	25 mm	29 mm	69.4 mm	8 sec.
100545	Pkg.1	11	12	10	M12-1.25	25 mm	32 mm	72.4 mm	8 sec.
100511	Pkg.1	11	12	22	M12-1.25	25 mm	57 mm	72.5 mm	5 sec.
100429	Pkg.1	11	12	8-10	M10-1.25	25 mm	58.5 mm	104 mm	10 sec.
100675	Pkg.1	11	12	10	M10-1	25 mm	83 mm	130 mm	8 sec.
100533	Pkg.1	11	12	6-11		27.5 mm	107 mm		6 sec.
100664	Pkg.1	11	12	10	M8-1	27.5 mm	47.5 mm	98.4 mm	<4.5 sec.
100627	Pkg.1	11	12	10	M8-1	27.5 mm	70 mm	118.9 mm	4.5 sec.
100593	Pkg.1	11	12	4.6	M8-1	27.5 mm	75 mm	119 mm	9 sec.
100663	Pkg.1	11	12	10	M8-1	27.5 mm	75 mm	124.1 mm	4.5 sec.
100674	Pkg.1	11	12	10	M10-1	27 mm	75 mm	117.4 mm	8 sec.
100263	Pkg.1	11	12	10	M10-1	28.5 mm	53.3 mm	98.5 mm	15 sec.
100544	Pkg.1	11	12	10	M10-1	28.5 mm	76 mm	132.5 mm	8 sec.
100086	Pkg.1	11	12	10	M14-1.25	28 mm	34 mm	77.4 mm	8 sec.
100283	Pkg.1	11	12	10	M10-1.25	28 mm	53 mm	101 mm	10 sec.
100514	Pkg.1	11	12	6	M10-1.25	28 mm	53 mm	101 mm	10 sec.
100642	Pkg.1	11	12	10	M9-1	29.5 mm	100 mm	150.9 mm	4.5 sec.
100595	Pkg.1	11	12	6	10-1	29.5 mm	60 mm	111.5 mm	10 sec.
100669	Pkg.1	11	12	10	M12-1.25	29 mm	26 mm	70 mm	8 sec.
100284	Pkg.1	11	12	10	M12-1.25	29 mm	32 mm	76.4 mm	8 sec.
100335	Pkg.1	11	12	10	M10-1	29 mm	46 mm	90.4 mm	8 sec.
100527	Pkg.1	11	12	10	M10-1	29 mm	46 mm	97 mm	8 sec.
100594	Pkg.1	11	12	6	M10-1	30.5 mm	77 mm	134 mm	10 sec.
100661	Pkg.1	11	12	10	M10-1.25	30 mm	83 mm	134.5 mm	8 sec.
100524	Pkg.1	11	12	6		30 mm	85 mm		8.5 sec.
100260	Pkg.1	11	12	11	M10-1.25	31.5 mm	43.5 mm	96 mm	20 sec.
100651	Pkg.1	11	12	10	M10-1.25	31 mm	100.5 mm	148.9 mm	8 sec.
100616	Pkg.1	11	12	10	M10-1	31 mm	77 mm	129.5 mm	8 sec.

HC-CARGO	Std. Pkg.	Voltage/ glow plug	Voltage/ battery	Ampere	Thread	L1	L2	L3	Glow duration
100291	Pkg.1	11	12	6	M10-1.25	32 mm	43.5 mm	95 mm	10 sec.
100516	Pkg.1	11	12	5	M10-1.25	32 mm	43.5 mm	97 mm	8 sec.
100536	Pkg.1	11	12	10	M10-1	32 mm	46 mm	106 mm	8 sec.
100523	Pkg.1	11	12	6	M10-1.25	33.5 mm	24.5 mm	80 mm	8.5 sec.
100644	Pkg.1	11	12	10	M10-1.25	33.5 mm	24 mm	72.9 mm	8 sec.
100590	Pkg.1	11	12	4.5	M10-1.25	36 mm	103 mm	159 mm	7 sec.
100556	Pkg.1	11	12	10	M10-1.25	37 mm	111.5 mm	170 mm	7 sec.
100331	Pkg.1	11.5	12	10	M12-1.25	22 mm	32 mm	69.4 mm	8 sec.
100307	Pkg.1	11.5	12	10	M10-1	26.5 mm	83 mm	124.9 mm	8 sec.
100337	Pkg.1	11.5	12	10	M12-1.25	27 mm	37 mm	87 mm	8 sec.
100339	Pkg.1	11.5	12	10	M12-1.25	27 mm	67.5 mm	115.9 mm	8 sec.
100537	Pkg.1	11.5	12	10	M10-1	27 mm	80.5 mm	130.5 mm	8 sec.
100177	Pkg.1	11.5	12	13		32 mm	62 mm		
100246	Pkg.1	12	12	8.5	M10-1.25	22 mm	52 mm	95 mm	20 sec.
100671	Pkg.1	12	12	10	M12-1.25	28.5 mm	26 mm	84 mm	8 sec.
100538	Pkg.1	12	12	10	M10-1	34.5 mm	70 mm	126.5 mm	8 sec.
100561	Pkg.1	12	12	12	M10-1	35 mm	95 mm	104.7 mm	10 sec.
100327	Pkg.1	12.5	12	10	M12-1.25	27.5 mm	67.5 mm	120.4 mm	8 sec.
100658	Pkg.1	20.5	24	5	M12-1.25	24 mm	96 mm	135.4 mm	10 sec.
100280	Pkg.1	21	24	5	M10-1.25	28 mm	53 mm	101 mm	20 sec.
100276	Pkg.1	23	24	4.8	M10-1.25	17 mm	33.5 mm	67 mm	10 sec.
100252	Pkg.1	23	24	7.5	M10-1.25	19 mm	33.5 mm	70 mm	20 sec.
100282	Pkg.1	23	24	4.6	M10-1.25	28 mm	53 mm	101 mm	20 sec.
100659	Pkg.1	23	24	5	M10-1	29 mm	46 mm	97 mm	10 sec.

GLOW PLUG RELAYS











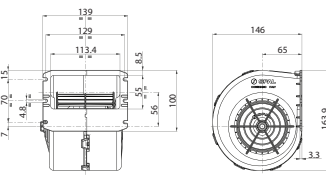

ITEM ID	Pre-heating time in sec. at +20 °C	Post heating		Temp. Measurement		Characteristic	ITEM ID	Pre-heating time in sec. at +20 °C	Post heating		Temp. Measurement		Characteristic
		w/	w/o	Int.	Ext.				w/	w/o	Int.	Ext.	
160416	< 8		✓	✓			160447	< 9	✓			✓	w/ "defect" warning.
160417	< 13		✓	✓			160448	< 9	✓			✓	w/ "defect" warning.
160418	< 8	✓		✓			160449	< 7	✓		✓		Can replace HC-CARGO 160441 and 160443 in connection w/ change to post heating glow plug.
160419	< 6	✓		✓									
160420	< 8	✓			✓								
160421	< 4	✓			✓		160451	< 7	✓			✓	
160422	< 18		✓		✓		160453			✓			
160423	< 14		✓	✓			160458	< 12	✓			✓	
160424	< 8		✓	✓			160459			✓			Model UWD.
160425	< 9		✓	✓			160460						For engines w/ electronic diesel control.
160426	< 7	✓		✓			160461			✓			
160431	< 10		✓	✓			160469	< 5	✓		✓		
160432	< 7	✓		✓			160718			✓			
160434	< 8	✓			✓		160719			✓			
160436	< 8	✓			✓		160795			✓			
160438	< 10	✓		✓			161120						
160441	< 9		✓	✓		w/ "defect" warning.	161735						
160442	< 9		✓	✓		w/ "defect" warning.	161736						
160443	< 9		✓	✓		w/ "defect" warning.	161737						
160445	< 9	✓			✓	w/ "defect" warning.	161738						
160446	< 9	✓			✓	w/ "defect" warning.	161739						
							161740						

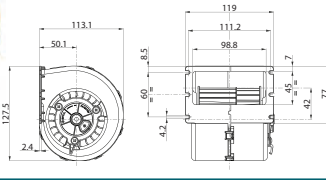
FANS & BLOWERS

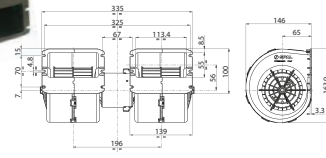

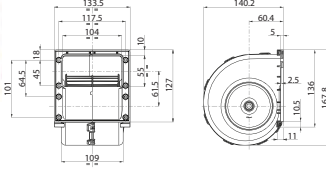

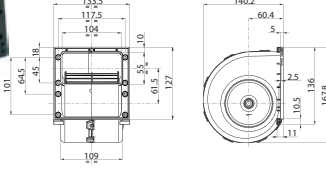
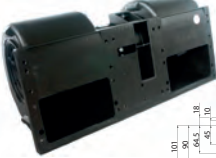
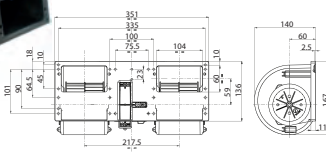

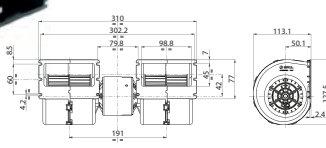
BLOWERS

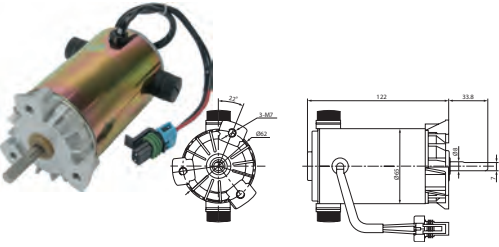
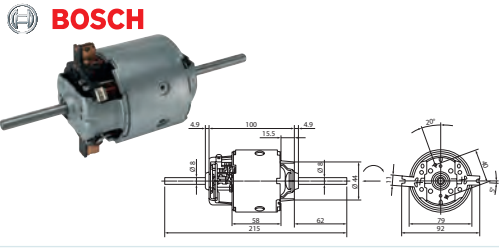

CENTRIFUGAL TYPE

160483 Centrifugal Blower Std pkg 1 Servicing: HC-CARGO 060216			
	Voltage: 12 Amp: 15	Dim.: 113.1x127.5 mm Shaft dia.: 50.1 mm Length: 310 mm Capacity: 750 m ³ Pressure: 0 PSI Speed: 3-speed	No./shafts: 2 Fan mounted: Yes Complete w/housing: Yes
160510 Centrifugal Blower Std pkg 1 Servicing: New Holland tractors - Visit our web catalogue for further information			
	Voltage: 12 Amp: 14	Dim.: 111.7x124.6 mm Shaft dia.: 54.9 mm Length: 317 mm Capacity: 650 m ³ Pressure: 0 PSI Speed: 3-speed	No./shafts: 2 Fan mounted: Yes Complete w/housing: Yes
160511 Centrifugal Blower Std pkg 1 Servicing: Deutz, New Holland - Visit our web catalogue for further information <i>This model have to be used w/ a static pressure that is higher than 0.1 psi. (pressure cabins).</i>			
	Voltage: 12 Amp: 34	Dim.: 139.8x167.5 mm Shaft dia.: 60 mm Length: 351 mm Capacity: 840 m ³ Pressure: 0 PSI Speed: 1-speed	No./shafts: 2 Fan mounted: Yes Complete w/housing: Yes
160512 Centrifugal Blower Std pkg 1			
	Voltage: 24 Amp: 15.9	Dim.: 139.8x167.5 mm Shaft dia.: 60 mm Length: 351 mm Capacity: 1160 m ³ Pressure: 0 PSI Speed: 3-speed	No./shafts: 2 Fan mounted: Yes Complete w/housing: Yes
160556 Centrifugal Blower Std pkg 1			
	Voltage: 24 Amp: 8.1	Dim.: 139.8x167.5 mm Shaft dia.: 60 mm Length: 351 mm Capacity: 850 m ³ Pressure: 0 PSI Speed: 3-speed	No./shafts: 2 Fan mounted: Yes Complete w/housing: Yes
160557 Centrifugal Blower Std pkg 1			
	Voltage: 24 Amp: 12	Dim.: 139.8x167.5 mm Shaft dia.: 60 mm Length: 351 mm Capacity: 1050 m ³ Pressure: 0 PSI Speed: 3-speed	No./shafts: 2 Fan mounted: Yes Complete w/housing: Yes

EL. SPECIFICATIONS		DIMENSIONS	ADDITIONAL SPECIFICATIONS
160592	Centrifugal Blower	Std pkg 1	
		Voltage: 12 Amp: 19.6	Dim.: 146x163.9 mm Shaft dia.: 65 mm Length: 139 mm Capacity: 540 m ³ Pressure: 0 PSI Speed: 3-speed
160593	Centrifugal Blower	Std pkg 1	
		Voltage: 12 Amp: 5	Dim.: 113.5x127.5 mm Shaft dia.: 50.1 mm Length: 119 mm Capacity: 260 m ³ Pressure: 0 PSI Speed: 3-speed
160594	Centrifugal Blower	Std pkg 1	
		Voltage: 24 Amp: 11	Dim.: 146x163.9 mm Shaft dia.: 65 mm Length: 335 mm Capacity: 1050 m ³ Pressure: 0 PSI Speed: 3-speed
160596	Centrifugal Blower	Std pkg 1	
		Voltage: 24 Amp: 11.1	Dim.: 140.2x167.8 mm Shaft dia.: 60.4 mm Length: 133.5 mm Capacity: 530 m ³ Pressure: 0 PSI Speed: 3-speed
160639	Centrifugal Blower	Std pkg 1	
		Voltage: 12 Amp: 19.9	Dim.: 140.2x167.8 mm Shaft dia.: 60.4 mm Length: 133.5 mm Capacity: 510 m ³ Pressure: 0 PSI Speed: 3-speed
160647	Centrifugal Blower	Std pkg 1	
		Voltage: 12 Amp: 17.2	Dim.: 140x167 mm Shaft dia.: 60 mm Length: 351 mm Capacity: 910 m ³ Pressure: 0 PSI Speed: 3-speed
160649	Centrifugal Blower	Std pkg 1	Servicing: HC-CARGO 060220
		Voltage: 24 Amp: 8.2	Dim.: 113.1x127.5 mm Shaft dia.: 50.1 mm Length: 310 mm Capacity: 750 m ³ Pressure: 0 PSI Speed: 3-speed



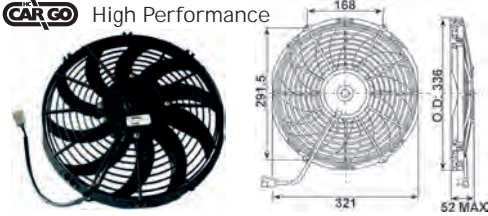
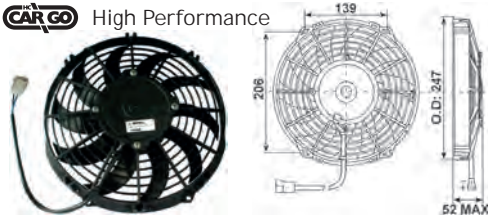
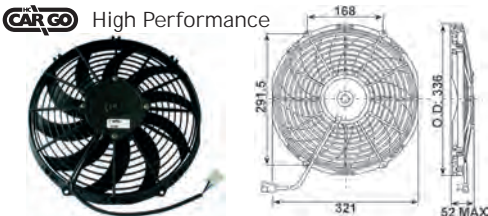
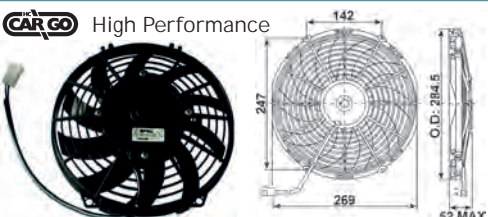
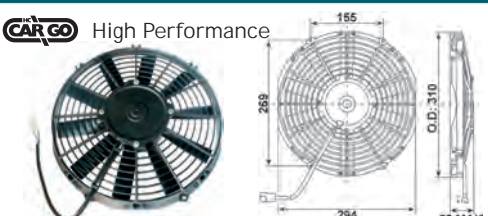





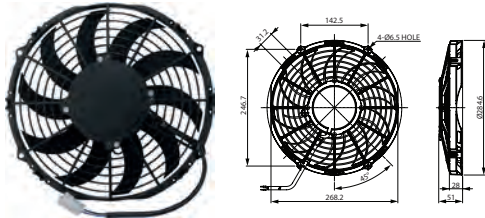
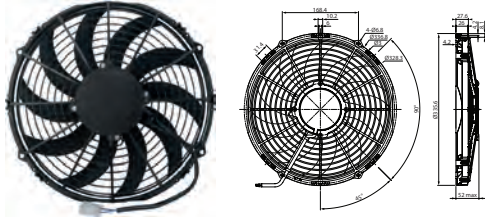
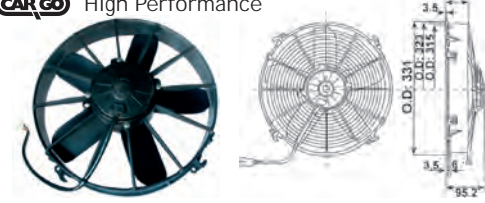
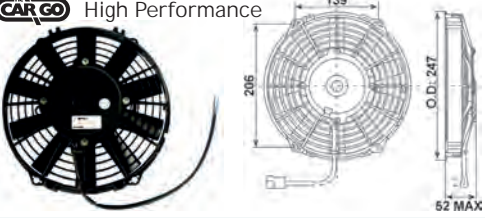

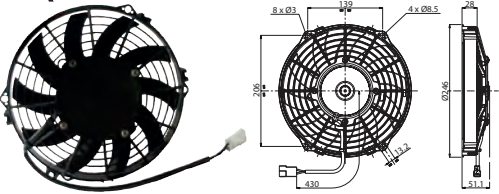

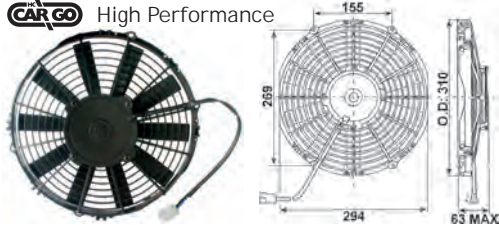
		EL. SPECIFICATIONS	DIMENSIONS	ADDITIONAL SPECIFICATIONS
160878 Centrifugal Blower				
Std pkg 1		Servicing: Volvo - Visit our web catalogue for further information		
	Voltage: 24	Dim.: 139.8x167.5 mm	No./shafts: 2	
	Amp: 12	Shaft dia.: 60 mm Length: 351 mm Capacity: 1050 m ³ Pressure: 0 PSI Speed: 4-speed	Fan mounted: Yes Complete w/housing: Yes	
FAN/HEATER MOTORS				
SINGLE SHAFTS				
160005 Universal Motor				
Std pkg 1		Servicing: Volvo - Visit our web catalogue for further information		
	Voltage: 12	Dia.: 60 mm	No./shafts: 1	
	Watt: 40	Shaft dia.: 8x22 mm Length: 121 mm Revolutions/min.: 2000 Speed: 1-speed	Fan mounted: No Complete w/housing: No	
160006 Universal Motor				
Std pkg 1		Servicing: Volvo - Visit our web catalogue for further information		
	Voltage: 24	Dia.: 60 mm	No./shafts: 1	
	Watt: 40	Shaft dia.: 8x22 mm Length: 121 mm Revolutions/min.: 2000 Speed: 1-speed	Fan mounted: No Complete w/housing: No	
160674 Universal Motor				
Std pkg 1		Servicing: Volvo - Visit our web catalogue for further information		
	Voltage: 12	Dim.: 58x107 mm Dia.: 51 mm Shaft dia.: 6 mm Length: 107 mm	No./shafts: 1 Fan mounted: No Complete w/housing: No	
	Servicing: Volvo - Visit our web catalogue for further information			
160734 Universal motor				
Std pkg 1		Servicing: Volvo - Visit our web catalogue for further information		
	Voltage: 12	Dia.: 73 mm Shaft dia.: 8 mm Length: 144 mm	No./shafts: 1 Fan mounted: No Complete w/housing: No	
	Servicing: Volvo - Visit our web catalogue for further information			
161712 Universal Motor				
Std pkg 1		Servicing: Carrier 54-00639-114 - Visit our web catalogue for further information		
	Voltage: 12	Dia.: 80 mm OD: 65 mm Shaft dia.: 7 mm Length: 118 mm Speed: 1-speed	No./shafts: 1 Fan mounted: No Complete w/housing: No	
	Servicing: Carrier 54-00639-114 - Visit our web catalogue for further information			

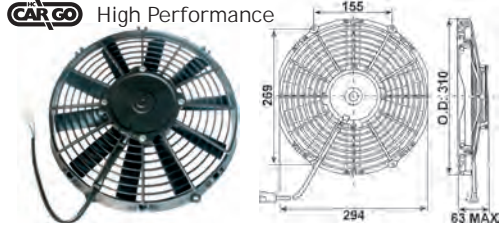
EL. SPECIFICATIONS		DIMENSIONS	ADDITIONAL SPECIFICATIONS
161718 Universal Motor	Std pkg 1		
	Voltage: 12	Dia.: 62 mm OD: 65 mm Shaft dia.: 8 mm Length: 122 mm Speed: 1-speed	No./shafts: 1 Fan mounted: No Complete w/housing: No
161719 Universal Motor	Std pkg 1	Servicing: Chrysler, MAN, Mercedes-Benz, Volvo - Visit our web catalogue for further information	
	Voltage: 24	Length: 215 mm	Fan mounted: No
DOUBLE SHAFTS			
160250 Universal Motor	Std pkg 1		
	Voltage: 12	Dia.: 90 mm Shaft dia.: 9.52x113 mm Length: 105 mm Revolutions/min.: 3200 Speed: 3-speed	No./shafts: 2 Fan mounted: No Complete w/housing: No
160251 Universal Motor	Std pkg 1		
	Voltage: 24	Dia.: 90 mm Shaft dia.: 9.52x112 mm Length: 107 mm Revolutions/min.: 2600 Speed: 3-speed	No./shafts: 2 Fan mounted: No Complete w/housing: No
160252 Universal Motor	Std pkg 1		
	Voltage: 24	Dia.: 82 mm Shaft dia.: 8x65 mm Length: 248 mm Revolutions/min.: 2500 Speed: 1-speed	No./shafts: 2 Fan mounted: No Complete w/housing: No
160253 Universal Motor	Std pkg 1		
	Voltage: 12	Dia.: 77.5 mm Shaft dia.: 8 mm Length: 254 mm Revolutions/min.: 3300 Speed: 3-speed	No./shafts: 2 Fan mounted: No Complete w/housing: No
160622 DC Motor	Std pkg 1	Servicing: Massey Ferguson 3070 - Visit our web catalogue for further information	
	Voltage: 12	Dia.: 73 mm Shaft dia.: 8x51 mm Length: 223 mm Revolutions/min.: 3100	Type: Blower No./shafts: 2 Fan mounted: No Complete w/housing: No

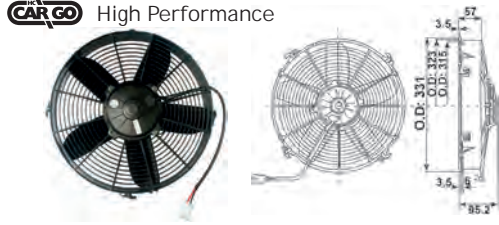
		EL. SPECIFICATIONS	DIMENSIONS	ADDITIONAL SPECIFICATIONS
160626	DC Motor	Std pkg 1	Servicing: Fiat tractors - Visit our web catalogue for further information	
		Voltage: 12	Dia.: 59.5 mm Shaft dia.: 8 mm Length: 198 mm Revolutions/min.: 4000	No./shafts: 2 Fan mounted: No Complete w/housing: No
AXIAL FANS				
12 V				
160536	Axial Fan	Std pkg 1		
		Voltage: 12 Amp: 6.2	OD: 336 mm Capacity: 1590 m ³	Type: Blower Fan mounted: Yes Tightness norm: IP 68 Alternativ no.: 161003
160537	Axial Fan	Std pkg 1		
		Voltage: 12 Amp: 6.7	OD: 247 mm Capacity: 1060 m ³	Type: Suction Fan mounted: Yes Tightness norm: IP 68
160538	Axial Fan	Std pkg 1		
		Voltage: 12 Amp: 6.7	OD: 336 mm Capacity: 1540 m ³	Type: Suction Fan mounted: Yes Tightness norm: IP 68 Alternativ no.: 161002
160539	Axial Fan	Std pkg 1		
		Voltage: 12 Amp: 8.7	OD: 284.5 mm Capacity: 1360 m ³	Type: Suction Fan mounted: Yes Tightness norm: IP 68 Alternativ no.: 161000
160598	Axial Fan	Std pkg 1		
		Voltage: 12 Amp: 7.8	OD: 310 mm Capacity: 1390 m ³	Type: Suction Fan mounted: Yes Tightness norm: IP 68
160601	Axial Fan	Std pkg 1		
		Voltage: 12 Amp: 7.7	OD: 310 mm Capacity: 1400 m ³	Type: Blower Fan mounted: Yes Tightness norm: IP 68

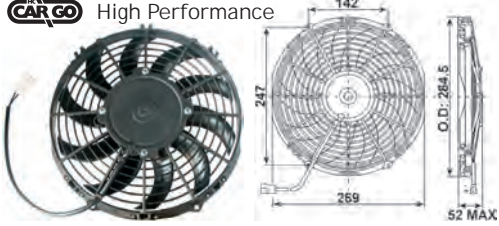
		EL. SPECIFICATIONS	DIMENSIONS	ADDITIONAL SPECIFICATIONS
160739 Axial Fan Std pkg 1 High Performance 		Voltage: 12 Amp: 15.6	OD: 331 mm Capacity: 2430 m ³	Type: Suction Fan mounted: Yes Tightness norm: IP 68
160910 Axial Fan Std pkg 1 High Performance 		Voltage: 12 Amp: 7.2	OD: 247 mm Capacity: 1080 m ³	Type: Blower Fan mounted: Yes Tightness norm: IP 68
160911 Axial Fan Std pkg 1 High Performance 		Voltage: 12 Amp: 7.6	OD: 284.5 mm Capacity: 1430 m ³	Type: Blower Fan mounted: Yes Tightness norm: IP 68
160912 Axial Fan Std pkg 1 High Performance 		Voltage: 12 Amp: 11.4	Dim.: 376x310x108 mm OD: 292 mm Capacity: 2280 m ³	Type: Blower Fan mounted: Yes Tightness norm: IP 68
160913 Axial Fan Std pkg 1 High Performance 		Voltage: 12 Amp: 15.3	OD: 331 mm Capacity: 2340 m ³	Type: Blower Fan mounted: Yes Tightness norm: IP 68
160914 Axial Fan Std pkg 1 High Performance 		Voltage: 12 Amp: 9.5	OD: 382 mm Capacity: 2220 m ³	Type: Suction Fan mounted: Yes Tightness norm: IP 68
160915 Axial Fan Std pkg 1 High Performance 		Voltage: 12 Amp: 8.7	OD: 382 mm Capacity: 2140 m ³	Type: Blower Fan mounted: Yes Tightness norm: IP 68

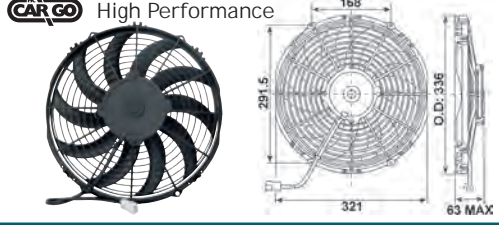
		EL. SPECIFICATIONS	DIMENSIONS	ADDITIONAL SPECIFICATIONS	
161000 HC-CARGO Axial Fan Std pkg 1			Voltage: 12 Amp: 9	OD: 284.6 mm Capacity: 1506 m ³	Type: Suction Tightness norm: IP 68 Alternativ no.: 160539
161002 HC-CARGO Axial Fan Std pkg 1			Voltage: 12 Amp: 7.5	OD: 335.6 mm Capacity: 1733 m ³	Type: Suction Tightness norm: IP 68 Alternativ no.: 160538
161003 HC-CARGO Axial Fan Std pkg 1			Voltage: 12 Amp: 7.5	OD: 335.6 mm Capacity: 1733 m ³	Type: Blower Tightness norm: IP 68 Alternativ no.: 160536
24 V					
160584 Axial Fan Std pkg 1			Voltage: 24 Amp: 7.4	OD: 331 mm Capacity: 2900 m ³	Type: Suction Fan mounted: Yes Tightness norm: IP 68 Alternativ no.: 161004
160587 Axial Fan Std pkg 1			Voltage: 24 Amp: 3.9	OD: 384.5 mm Capacity: 1300 m ³	Type: Suction Tightness norm: IP 68 Alternativ no.: 161001
160588 Axial Fan Std pkg 1			Voltage: 24 Amp: 4.1	OD: 247 mm Capacity: 1080 m ³	Type: Blower Fan mounted: Yes Tightness norm: IP 68
160595 Axial Fan Std pkg 1			Voltage: 24 Amp: 8.7	OD: 414 mm Capacity: 3540 m ³	Type: Blower Tightness norm: IP 68

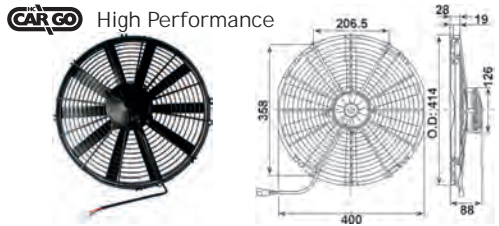
		EL. SPECIFICATIONS	DIMENSIONS	ADDITIONAL SPECIFICATIONS
160597 Axial Fan	Std pkg 1			
 High Performance		Voltage: 24 Amp: 3.9	OD: 247 mm Capacity: 1180 m ³	Type: Blower Fan mounted: Yes Tightness norm: IP 68
160599 Axial Fan	Std pkg 1			
 High Performance		Voltage: 24 Amp: 4.4	OD: 310 mm Capacity: 1690 m ³	Type: Suction Fan mounted: Yes Tightness norm: IP 68
160600 Axial Fan	Std pkg 1			
 High Performance		Voltage: 24 Amp: 4.1	OD: 310 mm Capacity: 1570 m ³	Type: Blower Tightness norm: IP 68
160619 Axial Fan	Std pkg 1			
 High Performance		Voltage: 24 Amp: 7.8	OD: 310 mm Capacity: 2440 m ³	Type: Blower Fan mounted: Yes Tightness norm: IP 68
160714 Axial Fan	Std pkg 1			
 High Performance		Voltage: 24 Amp: 3.7	OD: 284.5 mm Capacity: 1400 m ³	Type: Blower Tightness norm: IP 68
160737 Axial Fan	Std pkg 1			
 High Performance		Voltage: 24 Amp: 6	OD: 336 mm Capacity: 2240 m ³	Type: Blower Fan mounted: Yes Tightness norm: IP 68
160777 Axial Fan	Std pkg 1			
 High Performance		Voltage: 24 Amp: 8.4	OD: 414 mm Capacity: 3315 m ³	Type: Suction Tightness norm: IP 68

		EL. SPECIFICATIONS	DIMENSIONS	ADDITIONAL SPECIFICATIONS
160799 Axial Fan Std pkg 1		CAR GO High Performance 	Voltage: 24 Amp: 4 OD: 347 mm Capacity: 1170 m ³	Type: Suction Fan mounted: Yes Tightness norm: IP 68
160906 Axial Fan Std pkg 1		CAR GO High Performance 	Voltage: 24 Amp: 3.7 OD: 247 mm Capacity: 1070 m ³	Type: Suction Fan mounted: Yes Tightness norm: IP 68
160907 Axial Fan Std pkg 1		CAR GO High Performance 	Voltage: 24 Amp: 5.7 OD: 278 mm Capacity: 1990 m ³	Type: Suction Fan mounted: Yes Tightness norm: IP 68
160908 Axial Fan Std pkg 1		CAR GO High Performance 	Voltage: 24 Amp: 7.1 OD: 331 mm Capacity: 2760 m ³	Type: Blower Fan mounted: Yes Tightness norm: IP 68
160909 Axial Fan Std pkg 1		CAR GO High Performance 	Voltage: 24 Amp: 4.9 OD: 382 mm Capacity: 2170 m ³	Type: Suction Fan mounted: Yes Tightness norm: IP 68
160998 HC-CARGO Axial Fan Std pkg 1			Voltage: 24 Amp: 2.5 OD: 210.8 mm Capacity: 645 m ³	Type: Suction Tightness norm: IP 68
160999 HC-CARGO Axial Fan Std pkg 1			Voltage: 24 Amp: 2.5 OD: 210.8 mm Capacity: 645 m ³	Type: Blower Tightness norm: IP 68

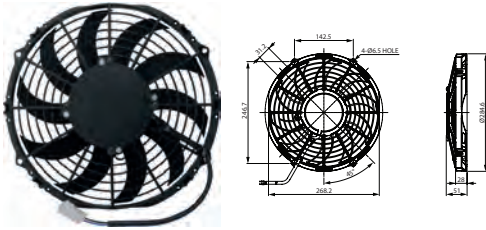
161001 HC-CARGO Axial Fan Std pkg 1

 Voltage: 24
Amp: 4

 OD: 284.6 mm
Capacity: 1437 m³

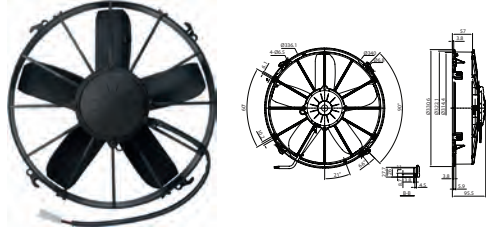
 Type: Suction
Tightness norm: IP 68
Alternativ no.: 160587

161004 HC-CARGO Axial Fan Std pkg 1

 Voltage: 24
Amp: 9

 OD: 330.6 mm
Capacity: 2976 m³

 Type: Suction
Tightness norm: IP 68
Alternativ no.: 160584

ACCESSORIES
160966 Mounting kit Std pkg 1

Total length: 180 mm

Washer: w/

CABIN HEATERS
060216 Cabin Heater Std pkg 1

The heater has three 75 mm tube connections on the air inlet side. There are also three 75 mm tube connections on the outlet side. The water connections can be placed on either side of the heater and also be turned towards either the inlet or the outlet side. Centrifugal Blower: HC-CARGO 160649.

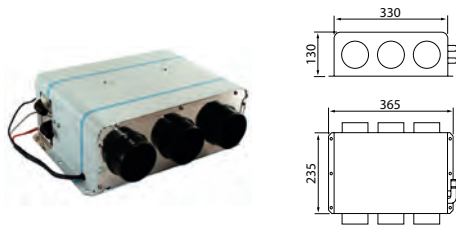

 Voltage: 12
Watt/speed 1: 60
Watt/speed 2: 77
Watt/speed 3:
114

 Dim.: 330x230x130 mm
Water connection OD: 16 mm
Capacity kW/speed 1: 7.2
Airflow speed 1: 264 m³/h
Capacity kW/speed 2: 9.3
Airflow speed 2: 357 m³/h
Capacity kW/speed 3: 12.2
Airflow speed 3: 504 m³/h
Regulation: Yes

Cabinet: Stainless steel

060220 Cabin Heater Std pkg 1

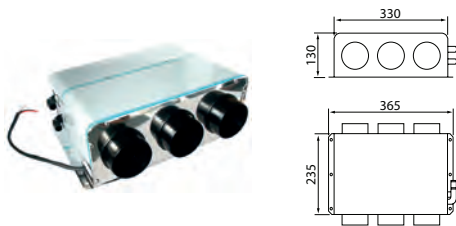
The heater has three 75 mm tube connections on the air inlet side. There are also three 75 mm tube connections on the outlet side. The water connections can be placed on either side of the heater and also be turned towards either the inlet or the outlet side. Centrifugal Blower: HC-CARGO 160649.



 Voltage: 24
Watt/speed 1: 60
Watt/speed 2: 77
Watt/speed 3:
114

 Dim.: 330x230x130 mm
Water connection OD: 16 mm
Capacity kW/speed 1: 7.2
Airflow speed 1: 264 m³/h
Capacity kW/speed 2: 9.2
Airflow speed 2: 357 m³/h
Capacity kW/speed 3: 12.2
Airflow speed 3: 504 m³/h
Regulation: Yes

Cabinet: Stainless steel

060222 Cabin Heater Std pkg 1

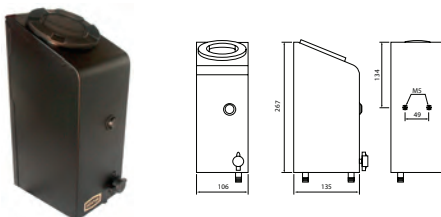
This Cabin heater is easily installed in small off road vehicles or as auxiliary heater in buses and delivery vans. The heating cycle is controlled by means of the built-in 1/4-turn water valve and the built-in switch. Heat-On 1331-12.



 Voltage: 12
Watt/speed 1: 42

 Dim.: 267x106x135 mm
Water connection OD: 12 mm
Capacity kW/speed 1: 2.5
Airflow speed 1: 120 m³/h

Cabinet: Metal

060223 Cabin Heater Std pkg 1

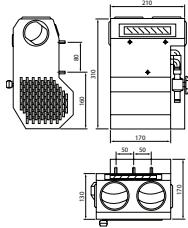
This very powerful cabin heater is used for airrecirculation and has all connections behind a cover allowing hoses and cables to be led in any direction. It has a powerful fan (230 W), controlled by means of a built-in 1/4-turn water valve. Efficient distribution of the air through the adjustable air vents provides for demisting of the cabin screens w/o the use of extra tubes and nozzles.



Voltage: 12
Watt/speed 3:
230

Dim.: 310x210x130 mm
Water connection OD: 16 mm
Capacity kW/speed 1: 4.3
Airflow speed 1: 180 m³/h
Capacity kW/speed 2: 6.3
Airflow speed 2: 288 m³/h
Capacity kW/speed 3: 9.2
Airflow speed 3: 468 m³/h
Regulation: Yes

Cabinet: Galvanized steel w/
black polyester

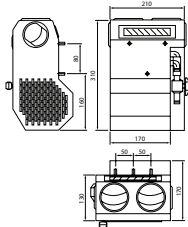
060233 Cabin Heater Std pkg 1

Voltage: 24
Watt/speed 3:
230

Dim.: 310x210x130 mm
Water connection OD: 16 mm
Capacity kW/speed 1: 4.3
Airflow speed 1: 180 m³/h
Capacity kW/speed 2: 6.3
Airflow speed 2: 288 m³/h
Capacity kW/speed 3: 9.2
Airflow speed 3: 468 m³/h
Regulation: Yes

Cabinet: Galvanized steel w/
black polyester

060235 Cabin Heater Std pkg 1

Especially suitable for heating the passenger room in for instance buses.

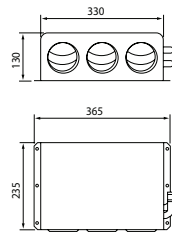

Voltage: 24
Watt/speed 1: 60
Watt/speed 2: 77
Watt/speed 3:
114

Dim.: 365x235x130 mm
Water connection OD: 16 mm
Capacity kW/speed 1: 7.2
Airflow speed 1: 264 m³/h
Capacity kW/speed 2: 9.3
Airflow speed 2: 357 m³/h
Capacity kW/speed 3: 12.2
Airflow speed 3: 504 m³/h
Regulation: Yes

Cabinet: Metal

060241 Cabin Heater Std pkg 1

Servicing: Delivery vans, excavators, park tractors - Visit our web catalogue for further information

Radiator: copper/aluminium.

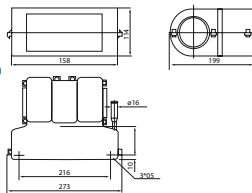

Voltage: 12
Watt/speed 2: 75

Dim.: 273x199x114 mm
Water connection OD: 16 mm
Capacity kW/speed 2: 4.3
Airflow speed 2: 230 m³/h
Regulation: Yes

Cabinet: Shockproof plastic

HEATER MOTORS

060059 Cabin Heater Motor Std pkg 1

Heat-on 1531M-2412.



Voltage: 12
Watt: 24

Dim.: 72 mm
Dia.: 70 mm
Shaft dia.: 6.35x16 mm
Length: 63 mm
Speed: 1-speed

Mount.: 3 holes
No./shafts: 1

060213 Cabin Heater Motor Std pkg 1

Heat-on 1531 M-5012.



Voltage: 12
Watt: 50

Dia.: 70 mm
Shaft dia.: 6.35x16 mm
Length: 63 mm
Speed: 2-speed

Mount.: 3 holes
No./shafts: 1
Fan mounted: No

060214 Cabin Heater Motor Std pkg 1

Heat-on 1531 M-5024.

 Voltage: 24
Watt: 50

 Dia.: 70 mm
Shaft dia.: 6.35x16 mm
Length: 63 mm
Speed: 1-speed

 Mount.: 3 holes
No./shafts: 1
Fan mounted: No

CONNECTORS
060229 Round Air Vent Std pkg 1

Heat-on 66231.

 ID: 70/76 mm
OD: 101 mm

ACCESSORIES
060058 Defroster Set Std pkg 1

Heat-on 1518.

 ID/demister tube
connection: 45 mm
ID/demister tube:
40 mm
Length: 160 cm

 Rubber elbows: 2
Demist nozzles: 2

060215 Fan Std pkg 1

Heat-on 1531-10.



OD: 120 mm

060219 Air Distribution Kit Std pkg 1 Servicing: HC-CARGO 060216, 060220

Heat-on 3050-30.

 ID/demister tube:
75 mm
Length: 620 cm

Demist nozzles: 3

060227 Water Valve Std pkg 1

Heat-on 2100.

 ID/demister tube
connection: 16 mm
Length: 11.2 cm

060237 Demister Tube Std pkg 1

 ID/demister tube:
50 mm

WIPER SYSTEMS

WIPER BLADES

FOR PASSENGER CARS

FLEXFIT

	HC-CARGO	Std Pkg	Length		Type
	161061	Pkg.1	350 mm	14"	For curved glass
	161062	Pkg.1	380 mm	15"	For curved glass
	161063	Pkg.1	400 mm	16"	For curved glass
	161064	Pkg.1	450 mm	18"	For curved glass
	161065	Pkg.1	470 mm	19"	For curved glass
	161066	Pkg.1	500 mm	20"	For curved glass
	161067	Pkg.1	530 mm	21"	For curved glass
	161068	Pkg.1	550 mm	22"	For curved glass
	161069	Pkg.1	600 mm	24"	For curved glass
	161070	Pkg.1	650 mm	26"	For curved glass
	161071	Pkg.1	700 mm	28"	For curved glass

161117 Display HC-CARGO Flexfit Std pkg 1 Servicing: HC-CARGO 161061...161071

Wiper Blade: HC-CARGO 161061..161071.



161118 Display HC-CARGO Flexfit Kit w/ wiper blades Std pkg 1

Consists: 1x HC-CARGO 161117. 4x HC-CARGO 161061. 4x HC-CARGO 161062. 4x HC-CARGO 161063. 6x HC-CARGO 161064. 6x HC-CARGO 161065. 6x HC-CARGO 161066. 6x HC-CARGO 161067. 6x HC-CARGO 161068. 6x HC-CARGO 161069. 4x HC-CARGO 161070. 4x HC-CARGO 161071.



STANDARD TYPE

160586 Wiper Blade Display w/o CARGO SIGN Std pkg 1 Servicing: Passenger cars - Visit our web catalogue for further information



	HC-CARGO	Std Pkg	Length		Type
	160628	Pkg.1	280 mm	11"	
	160633	Pkg.1	330 mm	13"	
	160635	Pkg.1	350 mm	14"	
	160638	Pkg.1	380 mm	15"	
	160641	Pkg.1	410 mm	16"	
	160643	Pkg.1	430 mm	17"	
	160645	Pkg.1	450 mm	18"	
	160648	Pkg.1	480 mm	19"	
	160650	Pkg.1	500 mm	20"	
	160653	Pkg.1	530 mm	21"	
	160655	Pkg.1	550 mm	22"	
	161580	Pkg.1	580 mm	23"	For curved glass
	160661	Pkg.1	610 mm	24"	

SPOILER

	HC-CARGO	Std Pkg	Length		Type
	160741	Pkg.1	400 mm	16"	
	160745	Pkg.1	450 mm	18"	
	160748	Pkg.1	480 mm	19"	
	160750	Pkg.1	510 mm	20"	
	160753	Pkg.1	530 mm	21"	
	160755	Pkg.1	550 mm	22"	
	160761	Pkg.1	610 mm	24"	
	160766	Pkg.1	660 mm	26"	
	160771	Pkg.1	710 mm	28"	

FOR TRUCKS

	HC-CARGO	Std Pkg	Length		Type
DOGA 	160321	Pkg.1	400 mm	16"	
	160322	Pkg.1	450 mm	18"	
	160323	Pkg.1	500 mm	20"	
	160325	Pkg.1	600 mm	24"	
	160326	Pkg.1	600 mm	24"	
	160327	Pkg.1	650 mm	26"	For curved glass
	160370	Pkg.1	650 mm	26"	
	160328	Pkg.1	700 mm	28"	
	160411	Pkg.1	700 mm	28"	
	160329	Pkg.1	800 mm	32"	
	161013	Pkg.1	900 mm	36"	
	160330	Pkg.1	1000 mm	40"	

INDUSTRIAL

	HC-CARGO	Std Pkg	Length		Type
DOGA 	160019	Pkg.1	300 mm	12"	For flat glass
	160028	Pkg.1	330 mm	13"	For flat glass
	160035	Pkg.1	350 mm	14"	For flat glass
	160025	Pkg.1	360 mm	14"	For flat glass
	160026	Pkg.1	400 mm	16"	For flat glass







MOUNTING PARTS

160758 Adapter Kit Std pkg 1 Servicing: HC-CARGO 160325

DOGA



Used on: Trucks

WIPER ARMS			
160022	Wiper Arm	Std pkg 1	Servicing: HC-CARGO 160031, 160032, 160033, 160034, 160506, 160558, 160292, 160293
DOGA			Dim./wiper arm: 8x2 mm Length: 390 mm Mount./wiper shaft: 6 mm Type: Single
160023	Wiper Arm	Std pkg 1	Servicing: HC-CARGO 160031, 160032, 160033, 160034, 160506, 160558, 160292, 160293, Opel
DOGA			Dim./wiper arm: 8x2 mm Length: 420 mm Mount./wiper shaft: 6 mm Type: Single
160024	Wiper Arm	Std pkg 1	Servicing: HC-CARGO 160031, 160032, 160033, 160034, 160506, 160558, 160292, 160293, Opel
DOGA			Dim./wiper arm: 8x2.5 mm Length: 450 mm Mount./wiper shaft: 6 mm Type: Single
160256	Wiper Arm	Std pkg 1	Servicing: HC-CARGO 160258, 160290, 160291, 160357, 160408, 160659, 160725, 161023
DOGA			Length: 450 mm Dist./wiper arms: 57 mm Mount./wiper shaft: M6 cone + M8 shaft mm Type: Parallel Length/adjustable: No
160257	Wiper Arm	Std pkg 1	Servicing: HC-CARGO 160258, 160290, 160291, 160357, 160408, 160659, 160725, 161023
DOGA			Length: 400 mm Dist./wiper arms: 57 mm Mount./wiper shaft: M6 cone + M8 shaft mm Type: Parallel Length/adjustable: No
160338	Wiper Arm	Std pkg 1	Servicing: HC-CARGO 160727, 160321, 160322
DOGA			Length: 700 mm Dist./wiper arms: 55 mm Mount./wiper shaft: 2x8 cone mm Type: Parallel Length/adjustable: No
160339	Wiper Arm	Std pkg 1	
Wiper motor: HC-CARGO 160292, 160293.			
DOGA			Length: 400 mm Dist./wiper arms: 57 mm Mount./wiper shaft: 6+M8 shaft mm Type: Parallel Length/adjustable: No

		EL. SPECIFICATIONS	DIMENSIONS	ADDITIONAL SPECIFICATIONS
160358	Wiper Arm	Std pkg 1	Servicing: HC-CARGO 160258, 160290, 160291, 160357, 160408, 160659, 160725, 161023	
 			Length: 500 mm Dist./wiper arms: 57 mm Mount./wiper shaft: M6 cone + M8 shaft mm	Type: Parallel Length/adjustable: No
160359	Wiper Arm	Std pkg 1	Servicing: HC-CARGO 160258, 160290, 160291, 160357, 160408, 160659, 160725, 161023	
 			Length: 550 mm Dist./wiper arms: 57 mm Mount./wiper shaft: M6 cone + M8 shaft mm	Type: Parallel Length/adjustable: No
160484	Wiper Arm	Std pkg 1	Servicing: HC-CARGO 161023, 160659	
 			Length: 340-420 mm Dist./wiper arms: 57 mm Mount./wiper blade: 9x2.5 mm hook Mount./wiper shaft: M8 cone + M8 shaft mm	Type: Parallel Length/adjustable: Yes
160485	Wiper Arm	Std pkg 1	Servicing: HC-CARGO 161023, 160659	
 			Length: 430-500 mm Dist./wiper arms: 57 mm Mount./wiper blade: 9x2.5 mm hook Mount./wiper shaft: M8 cone + M8 shaft mm	Type: Parallel Length/adjustable: Yes
160486	Wiper Arm	Std pkg 1		
 			Length: 340-420 mm Mount./wiper blade: 9x3 mm hook Mount./wiper shaft: M8 cone mm	Type: Single Length/adjustable: Yes
160487	Wiper Arm	Std pkg 1		
 			Length: 430-500 mm Mount./wiper blade: 9x3 mm hook Mount./wiper shaft: M8 cone mm	Type: Single Length/adjustable: Yes
160571	Wiper Arm	Std pkg 1	Servicing: HC-CARGO 161025	
 			Length: 680 mm Dist./wiper arms: 60 mm Mount./wiper shaft: 2x8 cone mm	Type: Parallel Length/adjustable: No

161021 Wiper Arm Std pkg 1

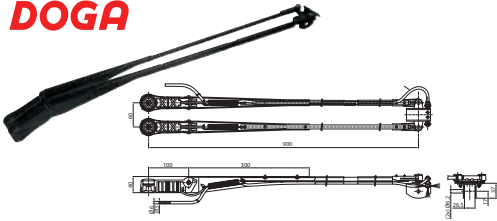
DOGA

MOUNTING PARTS

160727 K-Connector Std pkg 1 Servicing: HC-CARGO 160338

DOGA

Used on: Trucks

WIPER MOTORS

160150 Wiper Motor Std pkg 1 Servicing: Fiat 127, Lada 2101 - Visit our web catalogue for further information

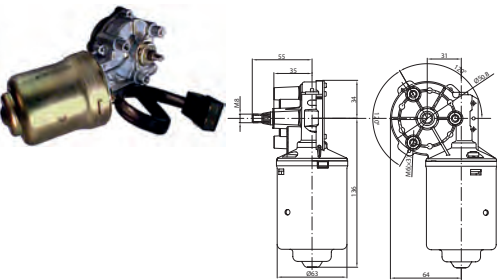

Voltage: 12

Type: OE

160395 Wiper Motor Std pkg 1 Servicing: Nissan Patrol 86-93 - Visit our web catalogue for further information

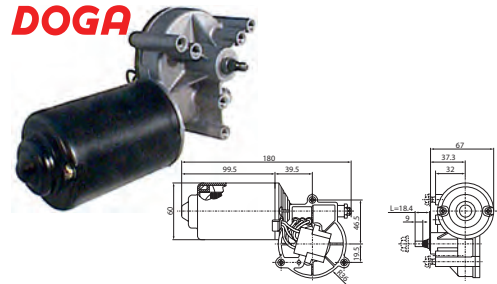
DOGA

Voltage: 12

 Type: OE
 Position: Rear windscreen
 Wiper shaft: w/ 1 M8 Shaft
 Auto stop: No

160396 Wiper Motor Std pkg 1 Servicing: Nissan Patrol 86-93 - Visit our web catalogue for further information

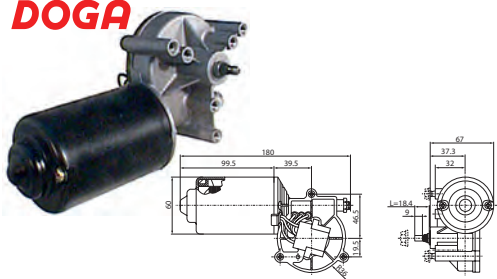
DOGA

Voltage: 24

 Type: OE
 Position: Rear windscreen
 Wiper shaft: w/ 1 M6 Shaft
 Auto stop: No

160671 Wiper Motor Std pkg 1 Servicing: Citroen, Fiat, Peugeot - Visit our web catalogue for further information



Voltage: 12

 Type: OE
 Position: Front windscreen

		EL. SPECIFICATIONS	DIMENSIONS	ADDITIONAL SPECIFICATIONS
160881 Wiper Motor Std pkg 1 Servicing: TEREX/SCHAEFF 5388665196 - Visit our web catalogue for further information		Voltage: 12	Shaft length: 38 mm	Type: OE Wiper shaft: w/ 1 Shaft Built in switch: No Auto stop: Yes Auto stop/placement: Left side
UNIVERSAL				
160031 Wiper Motor Std pkg 1 Servicing: HC-CARGO 160022, 160023, 160024 <i>Fitted w/ an interchangeable bearing allowing the shaft to be cut in any size.</i>				
DOGA		Voltage: 12	Wiper angle: 85°	Type: Universal Built in switch: Yes Auto stop: No
160032 Wiper Motor Std pkg 1 Servicing: HC-CARGO 160022, 160023, 160024 <i>Fitted w/ an interchangeable bearing allowing the shaft to be cut in any size.</i>				
DOGA		Voltage: 24	Wiper angle: 85°	Type: Universal Built in switch: Yes Auto stop: No
160033 Wiper Motor Std pkg 1 Servicing: HC-CARGO 160022, 160023, 160024 <i>Fitted w/ an interchangeable bearing allowing the shaft to be cut in any size.</i>				
DOGA		Voltage: 12	Wiper angle: 110°	Type: Universal Built in switch: Yes Auto stop: No
160034 Wiper Motor Std pkg 1 Servicing: HC-CARGO 160022, 160023, 160024 <i>Fitted w/ an interchangeable bearing allowing the shaft to be cut in any size.</i>				
DOGA		Voltage: 24	Wiper angle: 110°	Type: Universal Built in switch: Yes Auto stop: Yes
160258 Wiper Motor Std pkg 1 Servicing: HC-CARGO 160256, 160257, 160358, 160359 <i>w/ reciprocating shaft.</i>				
DOGA		Voltage: 12	Dist./shafts: 57 mm Wiper angle: 95°	Type: Universal Wiper shaft: w/ 2 shafts for parallelogram Built in switch: No Auto stop: Yes

EL. SPECIFICATIONS		DIMENSIONS		ADDITIONAL SPECIFICATIONS
160290 Wiper Motor Std pkg 1 Servicing: HC-CARGO 160256, 160257, 160358, 160359				
w/ reciprocating shaft.				
DOGA 		Voltage: 12 Dist./shafts: 57 mm Wiper angle: 95°		Type: Universal Wiper shaft: w/ 2 shafts for parallelogram Built in switch: No Auto stop: Yes Auto stop/placement: Left side
160291 Wiper Motor Std pkg 1 Servicing: HC-CARGO 160256, 160257, 160358, 160359				
w/ reciprocating shaft.				
DOGA 		Voltage: 24 Dist./shafts: 57 mm Wiper angle: 95°		Type: Universal Wiper shaft: w/ 2 shafts for parallelogram Auto stop: Yes Auto stop/placement: Left side
160292 Wiper Motor Std pkg 1 Servicing: HC-CARGO 160022, 160023, 160024				
w/ reciprocating shaft.				
DOGA 		Voltage: 12 Dist./shafts: 57 mm Wiper angle: 110°		Type: Universal Wiper shaft: w/ 2 shafts for parallelogram Built in switch: Yes Auto stop: No
160293 Wiper Motor Std pkg 1 Servicing: HC-CARGO 160022, 160023, 160024				
w/ reciprocating shaft.				
DOGA 		Voltage: 24 Dist./shafts: 57 mm Wiper angle: 110°		Type: Universal Wiper shaft: w/ 2 shafts for parallelogram Built in switch: Yes Auto stop: No
160357 Wiper Motor Std pkg 1 Servicing: HC-CARGO 160256, 160257, 160358, 160359				
w/ reciprocating shaft.				
DOGA 		Voltage: 12 Dist./shafts: 57 mm Wiper angle: 90°		Type: Universal Wiper shaft: w/ 2 shafts for parallelogram Built in switch: Yes Auto stop: No
160408 Wiper Motor Std pkg 1 Servicing: HC-CARGO 160256, 160257, 160358, 160359				
w/ reciprocating shaft.				
DOGA 		Voltage: 24 Dist./shafts: 57 mm Wiper angle: 95°		Type: Universal Wiper shaft: w/ 2 shafts for parallelogram Auto stop/placement: Right side

160503 Wiper Motor

Std pkg 1

DOGA

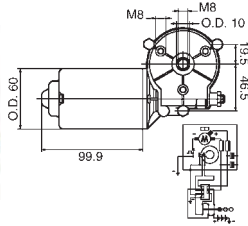

Voltage: 12

Type: Universal
Built in switch: No
Auto stop: Yes

160504 Wiper Motor

Std pkg 1

DOGA

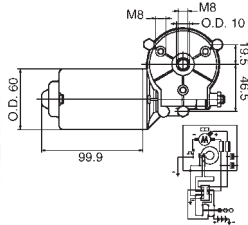

Voltage: 24

Type: Universal
Auto stop: Yes

160506 Wiper Motor

Std pkg 1

Servicing: HC-CARGO 160022, 160023, 160024

Moment: 0.8 NM.

DOGA

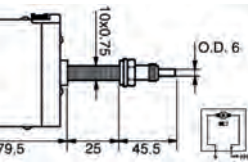

Voltage: 12

Wiper angle: 110°

Type: Universal
Wiper shaft: w/ 1 Shaft
Built in switch: Yes

160558 Wiper Motor

Std pkg 1

Servicing: HC-CARGO 160022, 160023, 160024

Black motor.

DOGA

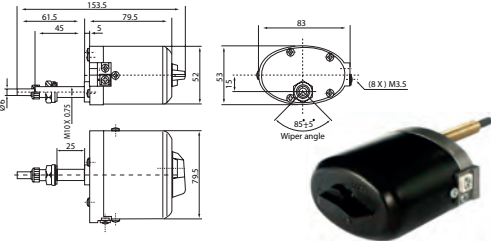

Voltage: 12

Wiper angle: 85°

Type: Universal
Position: Rear windscreen
Wiper shaft: w/ 1 Shaft
Built in switch: Yes

160659 Wiper Motor

Std pkg 1

Servicing: HC-CARGO 160256, 160257, 160358, 160359

1 speed.

DOGA



Voltage: 12

Dist./shafts: 57 mm
Wiper angle: 85°

Type: Universal
Wiper shaft: w/ 1 M6 Shaft
Built in switch: No
Auto stop: Yes

160725 Wiper Motor

Std pkg 1

Servicing: HC-CARGO 160256, 160257, 160358, 160359

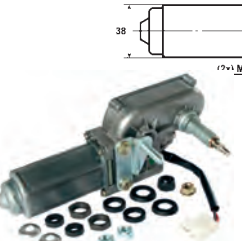

DOGA



Voltage: 12

Dist./shafts: 57 mm
Wiper angle: 90°

Type: Universal
Wiper shaft: w/ 2 shafts for parallelogram
Built in switch: Yes
Auto stop: Yes
Auto stop/placement: Right side

		EL. SPECIFICATIONS	DIMENSIONS	ADDITIONAL SPECIFICATIONS
161022 Wiper Motor Std pkg 1 DOGA 		Voltage: 24	Wiper angle: 90°	Type: Universal Built in switch: No
161023 Wiper Motor Std pkg 1 Servicing: HC-CARGO 160256, 160257, 160358, 160359 DOGA 		Voltage: 24	Dist./shafts: 57 mm Wiper angle: 85°	Type: Universal Wiper shaft: w/ 2 M8 shafts for parallelogram Built in switch: No
161024 Wiper Motor Std pkg 1 DOGA 		Voltage: 24	Wiper angle: 90°	Type: Universal Built in switch: No
161025 Wiper Motor Std pkg 1 DOGA 		Voltage: 24	Wiper angle: 40°	Type: Universal Built in switch: No
WINDSCREEN WASHERS				
KITS				
160186 Washer Kit Std pkg 1 <i>Pump: HC-CARGO 160386.</i> 		Voltage: 12	Dim.: 190x130x100 mm Can capacity: 1.2 l Capacity: 140 ml/min	Type: Complete kit Can: w/
160273 Washer Kit Std pkg 1 <i>Pump: HC-CARGO 160630.</i> 		Voltage: 24	Dim.: 190x130x100 mm Can capacity: 1.2 l	Type: Complete kit Can: w/

TANKS
12 V
160187 Washer Tank Std pkg 1

Washer pump: HC-CARGO 160360.

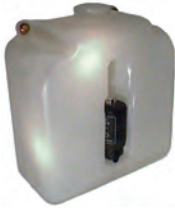
DOGA

Voltage: 12

 Dim.: 207x200x100 mm
 Can capacity: 3 l

 Type: Can
 Motor: w/

160973 Washer Tank 12 V Std pkg 1

Washer pump: HC-CARGO 160386.



Voltage: 12

 Dim.: 190x130x100 mm
 Can capacity: 1.2 l

 Type: Can
 Motor: w/
 Alternativ no.: 160186

24 V
160188 Washer Tank Std pkg 1

Washer pump: HC-CARGO 160360.

DOGA

Voltage: 24

 Dim.: 207x200x100 mm
 Can capacity: 3 l

 Type: Can
 Motor: w/

160967 Washer Tank Std pkg 1

Doga ref. 232.2001.30.00.

DOGA

Voltage: 24

 Dim.: 220x151.5x100 mm
 Can capacity: 2.1 l

 Type: Can
 Motor: w/

PUMPS
160197 Washer Pump Std pkg 1

Servicing: Porsche, Volvo, Volkswagen, Alfa Romeo, Audi, BMW, Fiat, Ford, Lancia, Mercedes-Benz, Opel, Porsche, Saab, Seat - Visit our web catalogue for further information



Voltage: 12

Capacity: 2400 ml/min

 Type: Standard
 Pump type: Single

160198 Washer Pump Std pkg 1



Servicing: Scania, Mercedes-Benz - Visit our web catalogue for further information



















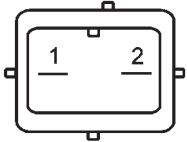

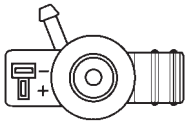
Voltage: 24

Capacity: 2400 ml/min

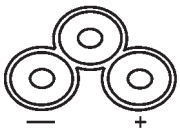
 Type: Universal
 Pump type: Single

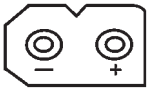
		EL. SPECIFICATIONS	DIMENSIONS	ADDITIONAL SPECIFICATIONS
160223	Washer Pump	Std pkg 1	Servicing: Peugeot 104, 504 - Visit our web catalogue for further information	
<i>For independent mounting in engine compartment.</i>				
		Voltage: 12	Capacity: 1500 ml/min	Type: Universal Pump type: Single
160289	Washer Pump	Std pkg 1	Servicing: Peugeot, Citroen, Renault - Visit our web catalogue for further information	
		Voltage: 24	Capacity: 1500 ml/min	Pump type: Single
160332	Washer Pump	Std pkg 1	Servicing: Peugeot, Citroen, Renault - Visit our web catalogue for further information	
		Voltage: 12	Capacity: 1500 ml/min	Pump type: Single
160360	Washer Pump	Std pkg 1	Servicing: HC-CARGO 160187, 160188, Rover Group, Honda	
		Voltage: 12	Capacity: 1400 ml/min	Type: Universal Pump type: Single
160361	Washer Pump	Std pkg 1	Servicing: Skoda Favorit - Visit our web catalogue for further information	
<i>Replacing original pump 115930290 on Skoda Favorit.</i>				
		Voltage: 12	Capacity: 1200 ml/min	Type: Standard Pump type: Single
160378	Washer Pump	Std pkg 1	Servicing: Ford, Opel, Seat, VW - Visit our web catalogue for further information	
		Voltage: 12	Capacity: 2200 ml/min	Pump type: Single
160379	Washer Pump	Std pkg 1	Servicing: Mercedes-Benz - Visit our web catalogue for further information	
		Voltage: 12	Capacity: 2200 ml/min	Type: Standard Pump type: Single

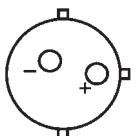
		EL. SPECIFICATIONS	DIMENSIONS	ADDITIONAL SPECIFICATIONS
160380	Washer Pump	Std pkg 1	Servicing: VW, Opel, Seat, Ford - Visit our web catalogue for further information	
		Voltage: 12	Capacity: 2400 ml/min	Type: Universal Pump type: Dual
160381	Washer Pump	Std pkg 1	Servicing: Fiat, Vauxhall, Audi, Ford, Opel, VW, Wartburg - Visit our web catalogue for further information	
		Voltage: 12	Capacity: 2000 ml/min	Type: Universal Pump type: Dual
160382	Washer Pump	Std pkg 1	Servicing: Opel, Seat, VW - Visit our web catalogue for further information	
		Voltage: 12	Capacity: 2400 ml/min	Type: Universal Pump type: Dual
160383	Washer Pump	Std pkg 1	Servicing: VW, Smart, Seat, Audi, BMW - Visit our web catalogue for further information	
		Voltage: 12	Capacity: 2200 ml/min	Type: Universal Pump type: Dual
160386	Washer Pump	Std pkg 1	Servicing: HC-CARGO 160186, 160973, Honda Accort, Peugeot (UK), Ford	
		Voltage: 12	Capacity: 1800 ml/min	Type: Universal Pump type: Single
160507	Washer Pump	Std pkg 1	Servicing: Daihatsu, Ford, Mazda - Visit our web catalogue for further information	
		Voltage: 24	Capacity: 1500 ml/min	Type: Universal Pump type: Single
160535	Washer Pump	Std pkg 1	Servicing: Daihatsu, Ford, Mazda - Visit our web catalogue for further information	
		Voltage: 12	Capacity: 1800 ml/min	Type: Standard Pump type: Dual

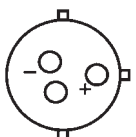
		EL. SPECIFICATIONS	DIMENSIONS	ADDITIONAL SPECIFICATIONS
160629 Washer Pump	Std pkg 1	Servicing: Citroen, Fiat, Peugeot - Visit our web catalogue for further information		
		Voltage: 12	Capacity: 1700 ml/min	Type: Standard Pump type: Dual
160630 Washer Pump	Std pkg 1	Servicing: HC-CARGO 160273		
		Voltage: 24	Capacity: 1800 ml/min	Type: Universal Pump type: Single
160677 Washer Pump	Std pkg 1	Servicing: Daewoo, Hyundai, Kia, Mazda, Mitsubishi, Toyota - Visit our web catalogue for further information		
		Voltage: 12	Capacity: 2000 ml/min	Type: Standard Pump type: Single
160679 Washer Pump	Std pkg 1	Servicing: Mercedes-Benz - Visit our web catalogue for further information		
		Voltage: 12	Capacity: 2100 ml/min	Type: Standard Pump type: Single
160680 Washer Pump	Std pkg 1	Servicing: BMW - Visit our web catalogue for further information		
		Voltage: 12	Capacity: 2300 ml/min	Type: Standard Pump type: Single
160681 Washer Pump	Std pkg 1	Servicing: Audi - Visit our web catalogue for further information		
		Voltage: 12	Capacity: 2400 ml/min	Type: Standard Pump type: Single
160682 Washer Pump	Std pkg 1	Servicing: Audi - Visit our web catalogue for further information		
		Voltage: 12	Capacity: 2400 ml/min	Type: Standard Pump type: Dual

EL. SPECIFICATIONS
DIMENSIONS
ADDITIONAL SPECIFICATIONS
160683 Washer Pump

Std pkg 1

Servicing: Audi, BMW, Mercedes-Benz, Seat, Skoda, VW - Visit our web catalogue for further information



Voltage: 12

Capacity: 2200 ml/min

 Type: Standard
 Pump type: Dual

JETS
160192 Washer Jet

Std pkg 10

 OD: 6.2 mm
 Length: 38 mm
 Thread: 9.5 mm

Jet: Dual

160686 Washer Jet

Std pkg 10

 OD: 15 mm
 Length: 9 mm

Jet: Single

160688 Washer Jet

Std pkg 10

Universal.

 OD: 5.8 mm
 Length: 30 mm
 Thread: 9.5 mm

Jet: Dual

161124 Washer Jet

Std pkg 1

Installation of wiper arms.

 Jet: Dual
 Alternativ no.: 160917

CONNECTIONS
160195 T-Connector

Std pkg 10

For hose I.D. 4 mm.

OD: 4 mm

Valve: w/o

160413 Pipe Connector

Std pkg 10

For hose I.D. 4 mm.

 OD: 8 mm
 Length: 32 mm

Valve: w/

RADIO ACCESSORIES

AERIALS

040077 Aerial Std pkg 1

Removable mast.



Ohm: 150

Length: 400 mm
Cable length: 1200 mm
Hole size: 8 mm
Mount. angle: 0-180

Colour: Black
Material: Rubber

040094 Aerial Extension Lead Std pkg 1



Cable length: 3500 mm

040181 Aerial Std pkg 1

Removable mast.



Ohm: 150

Length: 880 mm
Cable length: 1600 mm
Hole size: 18 mm
Mount. angle: 0-45

Colour: Black
Material: Fiber glass

040182 Aerial Std pkg 1

Removable mast.



Ohm: 75

Length: 880 mm
Cable length: 1600 mm
Hole size: 18 mm
Mount. angle: 0-45

Colour: Black
Material: Fiber glass

040190 Aerial Std pkg 1

Removable mast.



Ohm: 150

Length: 570 mm
Cable length: 1300 mm
Hole size: 18 mm
Mount. angle: 0-45

Colour: Black
Material: Fiber glass

040215 Aerial Std pkg 1

Extended.

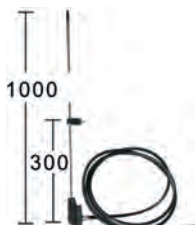

Ohm: 150

Length: 1000 mm
Cable length: 1500 mm
Hole size: 12 mm

Mount.: Pillar
Type: 3 sections
Colour: Black
Material: Stainless steel

EXTENSION LEADS
040019 Aerial Extension Lead Std pkg 1

Cable length: 1000 mm

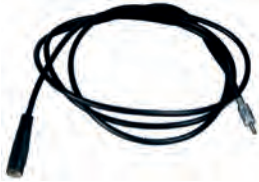
040192 Aerial Extension Lead Std pkg 1

Cable length: 2000 mm

PLUGS & SOCKETS
040096 Aerial Plug Std pkg 10

Male/female: Male

040199 Aerial Plug Std pkg 1

New standard (ISO).

040200 Aerial Adaptor Std pkg 5

New to old male plug ISO>DIN.

040201 Aerial Adaptor Std pkg 5

Old to new male plug DIN>ISO.

CAPACITORS
FOR CAR RADIOS
150100 Capacitor Std pkg 10

For car radios.

 El. capacitance:
2.2 μ F

Length: 100 mm

 Type: Universal
Mount. bracket: Straight
Plug: Straight
Cable: w/

150101 Capacitor		Std pkg 10	
<i>For car radios.</i>			
	El. capacitance: 2.2 μ F	Length: 80 mm	Type: Universal Mount. bracket: Angled Plug: Angled Cable: w/
150407 Capacitor		Std pkg 10	
<i>For car radios.</i>			
	El. capacitance: 2.2 μ F	Length: 40 mm	Type: Universal Mount. bracket: Angled Plug: Angled Cable: w/
150408 Capacitor		Std pkg 10	
<i>For car radios.</i>			
	El. capacitance: 2.2 μ F	Length: 100 mm	Type: Universal Mount. bracket: Angled Plug: Ring Cable: w/
LOUDSPEAKER IN CABINET			
040197 Speakers		Std pkg 1	
	Watt: 20/40 Ohm: 4	Length: 97 mm Depth: 95 mm Width: 95 mm	Cabinet: Yes Mount. bracket: w/ Unit: Set
LOUDSPEAKER BUILT-IN			
040193 Speakers		Std pkg 1	
<i>70-23000 Hz.</i>			
	Watt: 150 Ohm: 4	ID/hole: 95 mm Depth: 50 mm Dist./mount. holes 1: 80 mm Dist./mount. holes 2: 115 mm Width: 100 mm	Type: Built-in System: 2 way Grill: w/ Unit: Set
RADIO MOUNTING KITS			
040149 Radio Box		Std pkg 1	
			Colour: Black Material: Acrylic Mount. bracket: Pendant Integral front: Yes

040170 Radio Mounting Kit Std pkg 1

Galvanized. w/ gasket.



Integral front: Yes

DASHBOARD GAUGES

AMMETER

160697 Ammeter Std pkg 1

White figures.

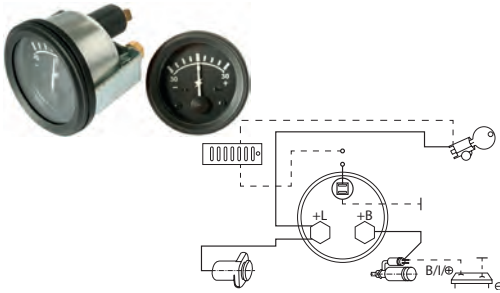

Voltage: 12-24

OD: 52 mm

Mount. type: Hook fastening
Colour: Black
Measuring range: 30-0-30

160698 Ammeter Std pkg 1

White figures.

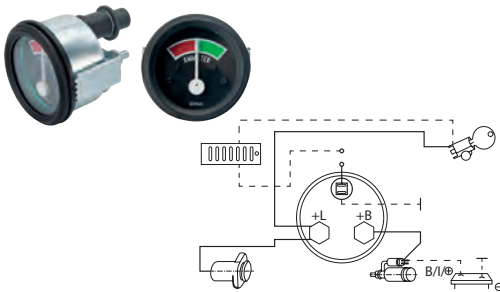

Voltage: 12-24

OD: 52 mm

Mount. type: Hook fastening
Colour: Black
Measuring range: 60-0-60

161716 Ammeter Std pkg 1 Servicing: HC-CARGO 181679, 181680, 181681

Mounting hole: 29 mm. 6.3 mm terminals.

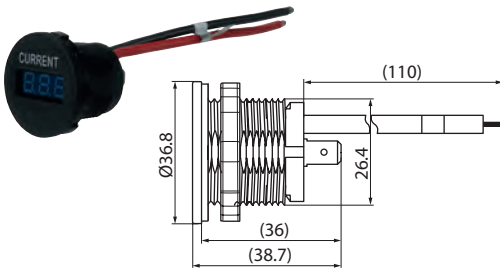

Voltage: 12/24

ID: 26.4 mm
OD: 36.8 mm

Mount. type: Built-in
Colour: Black
Measuring range: 0-20
Digital: Yes

VOLTMETER

160695 Voltmeter Std pkg 1

White figures.

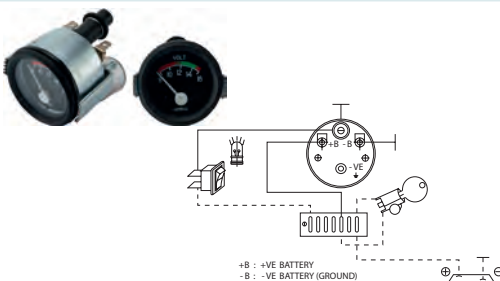

Voltage: 8-16

OD: 52 mm

Mount. type: Hook fastening
Colour: Black
Measuring range: 8-16

160696 Voltmeter Std pkg 1

White figures.

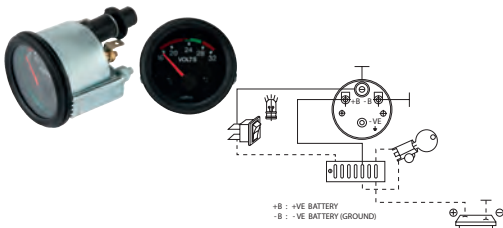

Voltage: 16-32

OD: 52 mm

Mount. type: Hook fastening
Colour: Black
Measuring range: 16-32

161714 Voltmeter Std pkg 1 Servicing: HC-CARGO 181679, 181680, 181681

Mounting hole: 29 mm. 6.3 mm terminals.

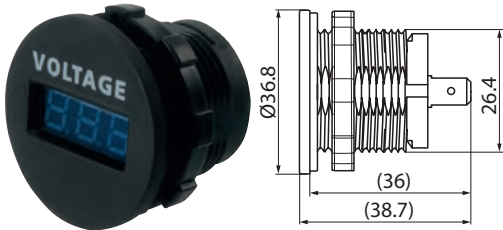

Voltage: 6-33

ID: 26.4 mm
OD: 36.8 mm

Mount. type: Built-in
Colour: Black
Measuring range: 0-36
Digital: Yes

161715 Voltmeter Std pkg 1 Servicing: HC-CARGO 181679, 181680, 181681

Mounting hole: 29 mm. 6.3 mm terminals.



Voltage: 12/24

ID: 26.4 mm
OD: 36.8 mm

Mount. type: Built-in
Colour: Black
Measuring range: 11-32 V
Digital: Yes

HOUR METER

160702 Hour Meter Std pkg 1

w/o illumination. IP65.

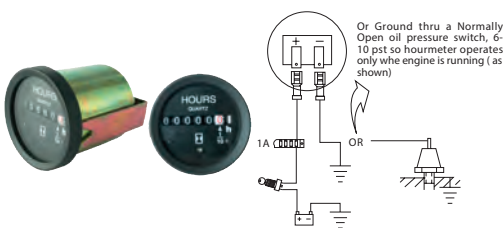

Voltage: 12-28

OD: 52 mm

Type: Mechanical
Mount. type: Hook fastening
Colour: Black

160747 Hour Meter Std pkg 1

w/o illumination.

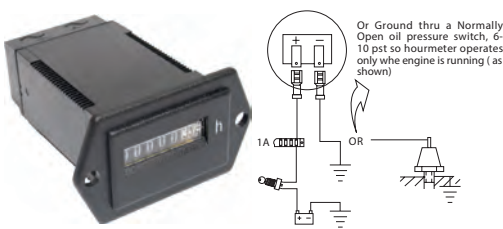

Voltage: 10-28

OD: 36.5x25 mm

Type: Electrical operated
Colour: Black

160897 Hour Meter Std pkg 1

Digital.

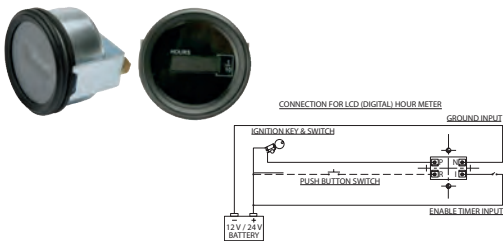

Voltage: 10-28

OD: 52 mm

Type: Electrical operated
Mount. type: Hook fastening
Colour: Black
Digital: Yes

FUEL GAUGES

160701 Fuel Gauge 12V Std pkg 1

10-180 Ohm. Fuel Gauge: HC-CARGO 160873.



Voltage: 12

OD: 52 mm

Mount. type: Hook fastening
Colour: Black
Sender: w/

160872 Fuel Gauge 24V Std pkg 1

Fuel Gauge: HC-CARGO 160873.



Voltage: 24

OD: 52 mm

Mount. type: Hook fastening
Colour: Black
Sender: w/

160873 Fuel Gauge Std pkg 1

Servicing: HC-CARGO 160701, 160872



Voltage: 12/24

OD: 52 mm

WATER TEMP. GAUGES

160699 Water Temp. Gauge Std pkg 1

Transmitter 1/8" NPTF: HC-CARGO 160786.

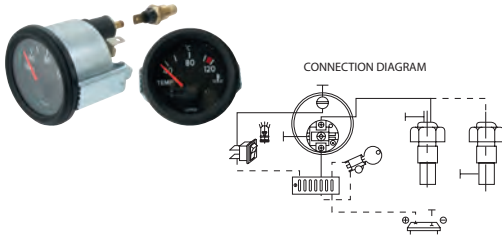

Voltage: 12

OD: 52 mm

Type: Electrical operated
Mount. type: Hook fastening
Colour: Black
Measurement range: 40-120
Sender: w/

160778 Water Temp. Gauge Std pkg 1

Transmitter 1/8" NPTF: HC-CARGO 160786.

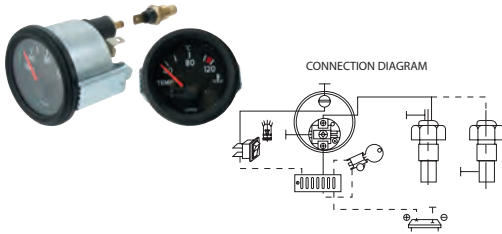

Voltage: 24

OD: 52 mm

Type: Electrical operated
Mount. type: Hook fastening
Colour: Black
Measurement range: 40-120
Sender: w/

OIL PRESSURE GAUGES

160700 Electrical Oil Pressure Gauge Std pkg 1

Transmitter 1/8" NPTF: HC-CARGO 160787.



Voltage: 12

OD: 52 mm

Type: Electrical operated
Mount. type: Hook fastening
Colour: Black
Measuring range: 0-10
Sender: w/

160779 Oil Pressure Gauge Std pkg 1

Transmitter 1/8" NPTF: HC-CARGO 160787.

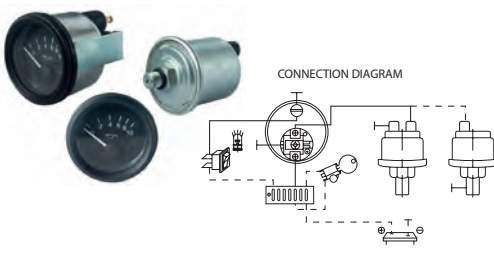

Voltage: 24

OD: 52 mm

Type: Electrical operated
Mount. type: Hook fastening
Colour: Black
Measuring range: 0-10
Sender: w/

IGNITION COMPONENTS

IGNITION COILS

150246 Electronic Ignition Coil Std pkg 1 Servicing: Alfa Romeo, Fiat, Lancia - Visit our web catalogue for further information

2 units on each vehicle.



Voltage: 12

Type: Dry
No./terminals: 2

150252 Electronic Ignition Coil Std pkg 1 Servicing: Alfa Romeo, Citroen, Fiat, Honda, Kia, Lancia, Land Rover, Peugeot - Visit our web catalogue for further information

2 units on each vehicle.



Voltage: 12

Type: Dry
No./terminals: 3

150259 Electronic Ignition Coil Std pkg 1 Servicing: Citroen, Fiat, Innocenti, Lancia, Peugeot - Visit our web catalogue for further information



Voltage: 12

Type: Dry
No./terminals: 4

150266 Electronic Ignition Coil Std pkg 1 Servicing: Toyota - Visit our web catalogue for further information



Voltage: 12



Type: Dry
No./terminals: 2

150270 Electronic Ignition Coil Std pkg 1 Servicing: Honda, Rover - Visit our web catalogue for further information



Voltage: 12

Type: Dry
No./terminals: 2

		EL. SPECIFICATIONS	DIMENSIONS	ADDITIONAL SPECIFICATIONS
150416	Electronic Ignition Coil	Std pkg 1	Servicing: Mazda, Ford - Visit our web catalogue for further information Voltage: 12	Type: Dry No./terminals: 3
				
150424	Electronic Ignition Coil	Std pkg 1	Servicing: Daewoo, Mercedes-Benz, Puch (Steyr-Daimler), Ssangyong, VW - Visit our web catalogue for further information Voltage: 12	Type: Dry
				
150428	Electronic Ignition Coil	Std pkg 1	Servicing: Audi, Seat, Skoda, VW - Visit our web catalogue for further information Voltage: 12	Type: Dry
				
150433	Electronic Ignition Coil	Std pkg 1	Servicing: Nissan, Renault - Visit our web catalogue for further information Voltage: 12	Type: Dry
				
150434	Electronic Ignition Coil	Std pkg 1	Servicing: Renault - Visit our web catalogue for further information Voltage: 12	Type: Dry
				
150441	Electronic Ignition Coil	Std pkg 1	Servicing: Nissan, Renault - Visit our web catalogue for further information Voltage: 12	Type: Dry
				
150505	Electronic Ignition Coil	Std pkg 1	Servicing: Nissan, Opel, Renault, Vauxhall - Visit our web catalogue for further information Voltage: 12	Type: Dry, Pencil
				

		EL. SPECIFICATIONS	DIMENSIONS	ADDITIONAL SPECIFICATIONS
150508	Electronic Ignition Coil	Std pkg 1	Servicing: Audi, Seat, Skoda, VW - Visit our web catalogue for further information Voltage: 12	Type: Dry, Pencil
				
150509	Electronic Ignition Coil	Std pkg 1	Servicing: Audi, Seat, Skoda, VW - Visit our web catalogue for further information Voltage: 12	Type: Dry, Pencil
				
150513	Electronic Ignition Coil	Std pkg 1	Servicing: Skoda, VW - Visit our web catalogue for further information Voltage: 12	Type: Dry, Pencil No./terminals: 4
				
150520	Electronic Ignition Coil	Std pkg 1	Servicing: Citroen, Peugeot - Visit our web catalogue for further information Voltage: 12	Type: Dry
				
150521	Electronic Ignition Coil	Std pkg 1	Servicing: Opel, Vauxhall - Visit our web catalogue for further information Voltage: 12	Type: Dry
				
150522	Electronic Ignition Coil	Std pkg 1	Servicing: Citroen, Peugeot - Visit our web catalogue for further information Voltage: 12	Type: Dry
				
150525	Electronic Ignition Coil	Std pkg 1	Servicing: Opel - Visit our web catalogue for further information Voltage: 12	Type: Dry
				

UNIVERSAL
150037 Electronic Ignition Coil Std pkg 1

Universal.

Voltage: 12

OD: 55 mm

 Type: Oil cooled
 No./terminals: 2

150169 Electronic Ignition Coil Std pkg 1

Universal.

Voltage: 12

OD: 60 mm

 Type: Oil cooled, Super
 No./terminals: 2

150395 Electronic Ignition Coil Std pkg 1 Servicing: Hitachi, BMW - Visit our web catalogue for further information
w/ external resistor. Universal.

Voltage: 12

 Type: Dry, High Power
 No./terminals: 2
 Terminals w/thread: Yes

MODULES
150055 Ignition Module Std pkg 1

Servicing: Alfa Romeo, BMW, Citroen, Fiat, Mercedes-Benz, Opel, Peugeot, Talbot, Vauxhall, Zastava - Visit our web catalogue for further information

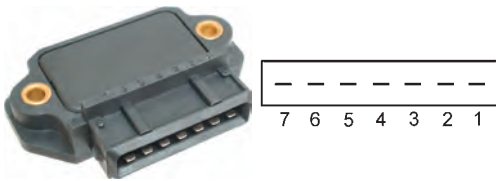
Also repl. ignition modules w/ 6 terminals.

 Type: Pick up
 Terminals: 7
 1: KI1
 2: KI31/Ground
 3: KI31/Ground
 4: KI15
 5: G+
 6: G-
 7: TACH/rpm

150056 Ignition Module Std pkg 1

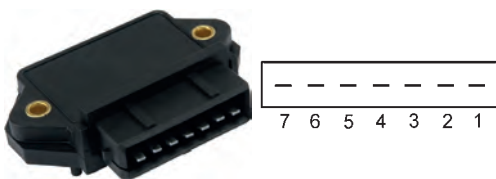

Servicing: Alfa, BMW, GM, KHD, Renault, Audi, Opel, Porsche, Saab, Seat, Vauxhall, Volvo, VW - Visit our web catalogue for further information







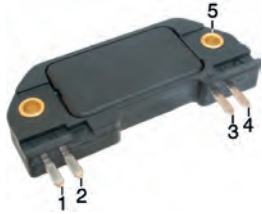
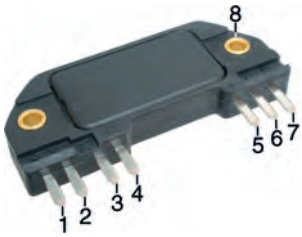
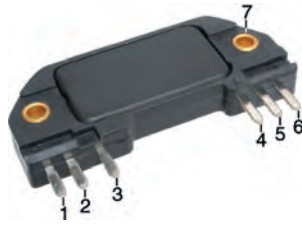
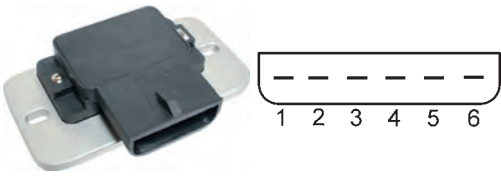
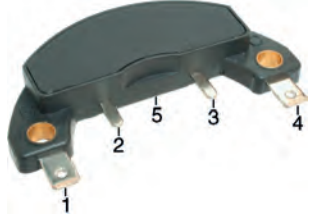

Also repl. ignition modules w/ 6 terminals.

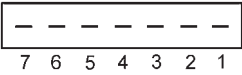
 Type: Hall
 Terminals: 7
 1: KI1
 2: KI31/Ground
 3: KI31/Ground
 4: KI15
 5: G+
 6: G°
 7: TACH/rpm

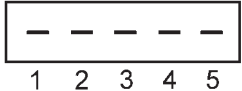

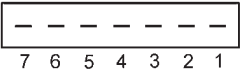

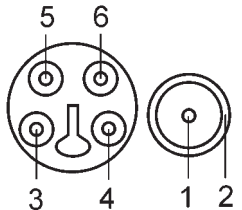



150057 Ignition Module Std pkg 1

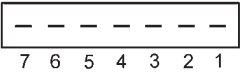

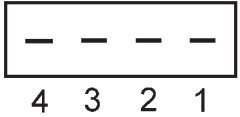

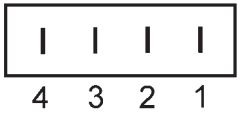
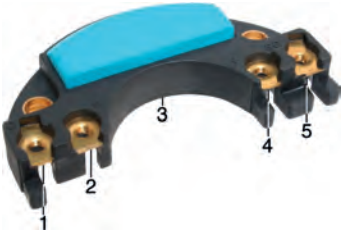
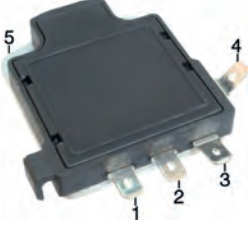
Servicing: Alfa Romeo, Citroen, Ford, Peugeot - Visit our web catalogue for further information

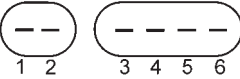
 Type: Pick up
 Terminals: 5
 1: KI1
 2: KI31/Ground
 3: KI15
 4: G+
 5: G-

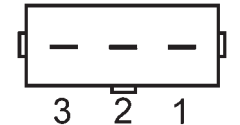
		EL. SPECIFICATIONS	DIMENSIONS	ADDITIONAL SPECIFICATIONS
150058	Ignition Module	Std pkg 1	Servicing: AMC, GM, Opel, Peugeot, Vauxhall, Alfa Romeo, Autobianchi, Fiat, Lancia, Polski-Fiat, Renault - Visit our web catalogue for further information	
				Type: Pick up Terminals: 5 1: G-/W 2: G+/G 3: K115/B 4: K11/C 5: K131/Ground
150062	Ignition Module	Std pkg 1	Servicing: AMC, Buick, Cadillac, Chevrolet, GM, Jeep, Oldsmobile, Pontiac, Opel, Vauxhall - Visit our web catalogue for further information	
				Type: Pick up Terminals: 5 1: G- 2: G+ 3: K115 4: K11 5: K131/Ground
150063	Ignition Module	Std pkg 1	Servicing: GM, Honda, Opel, Vauxhall - Visit our web catalogue for further information	
				Type: Pick up Terminals: 8 1: G+/P 2: G-/N 3: Input/E 4: Output/R 5: K115/+ 6: K11/C 7: Output/B 8: K131/Ground
150064	Ignition Module	Std pkg 1	Servicing: Opel, Vauxhall - Visit our web catalogue for further information	
				Type: Pick up Terminals: 7 1: G+/P 2: G-/N 3: Input/T 4: K115/+ 5: K11/C 6: Output/0 7: K131/Ground
150067	Ignition Module	Std pkg 1	Servicing: Ford, Renault V.I. - Visit our web catalogue for further information	
				Type: Pick up Terminals: 6 1: K11 2: K115 3: NC 4: G+ 5: G- 6: K131/Ground
150068	Ignition Module	Std pkg 1	Servicing: Chrysler, Mazda, Mitsubishi - Visit our web catalogue for further information	
				Type: Pick up Terminals: 5 1: K115/B 2: G- 3: G+ 4: K11/C 5: K131/Ground
150072	Ignition Module	Std pkg 1	Servicing: Ford - Visit our web catalogue for further information	
				Type: Pick up Terminals: 5 1: G+ 2: G- 3: K115 4: K131/Ground 5: K11

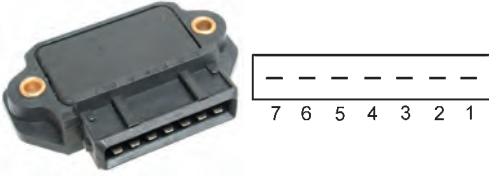
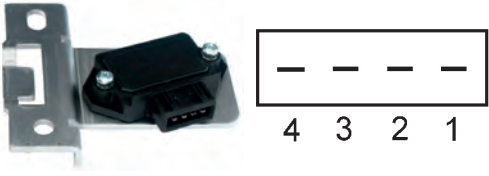
		EL. SPECIFICATIONS	DIMENSIONS	ADDITIONAL SPECIFICATIONS
150075	Ignition Module	Std pkg 1	Servicing: Audi, Saab, Seat, Volvo, VW, Wartburg - Visit our web catalogue for further information	Type: Hall Terminals: 7 1: K11 2: K131/Ground 3: K131/Ground 4: K115 5: G+ 6: G° 7: TACH/rpm
				
150088	Ignition Module	Std pkg 1	Servicing: Fiat, Innocenti, Lancia - Visit our web catalogue for further information	Type: Pick up Terminals: 5 1: G- 2: G+ 3: K115 4: K11 5: K131/Ground
				
150096	Ignition Module	Std pkg 1	Servicing: Chrysler, Hyundai, Mazda, Mitsubishi - Visit our web catalogue for further information	Type: Pick up Terminals: 3 1: K131/Ground 2: K115/B 3: K11/C
				
150098	Ignition Module	Std pkg 1	Servicing: Volvo, Citroen, Opel, Peugeot, Porsche, Renault V.I., Saab, Seat, Vauxhall - Visit our web catalogue for further information	Type: Amplifier Terminals: 6 1: K11 2: K131/Ground 3: K131/Grounda 4: K115 5: Input 6: NC 7: NC
				
150154	Ignition Module	Std pkg 1	Servicing: Mercedes-Benz, Puch (Steyr-Daimler) - Visit our web catalogue for further information	Type: Pick up Type/terminal: Bullet Terminals: 6 1: G+ 2: G- 3: K11/16 4: K115 5: K131/Ground 6: TACH/rpm
				
150157	Ignition Module	Std pkg 1	Servicing: Toyota - Visit our web catalogue for further information	Type: Pick up Terminals: 6 1: K115/B (Red) 2: K11/C (Yellow) 3: K131/Ground 4: TACH/rpm 5: + 6: -
				
150160	Ignition Module	Std pkg 1	Servicing: Ford, Nissan, Suzuki, Mazda - Visit our web catalogue for further information	Type: Pick up Terminals: 5 1: K115/B 2: K11/C 3: G+ 4: G- 5: K131/Ground
				

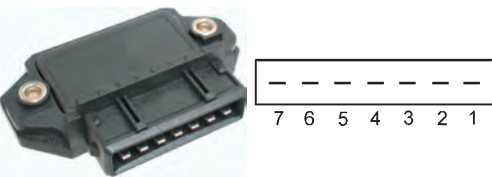
		EL. SPECIFICATIONS	DIMENSIONS	ADDITIONAL SPECIFICATIONS
150165	Ignition Module	Std pkg 1	Servicing: Alfa Romeo, Ferrari, Fiat, Lancia - Visit our web catalogue for further information	Type: Amplifier Terminals: 7 1: KI1 2: KI31/Ground 3: KI31/Ground 4: KI15 5: NC 6: Input 7: NC
				
150175	Ignition Module	Std pkg 1	Servicing: Opel, Vauxhall - Visit our web catalogue for further information	Type: Amplifier Terminals: 4 1: KI1 2: KI31/Ground 3: KI15 4: Input Alternativ no.: 150380
				
150215	Ignition Module	Std pkg 1	Servicing: Skoda - Visit our web catalogue for further information	Type: Pick up Terminals: 5 1: KI15 2: G- 3: G+ 4: KI1 5: KI31/Ground
				
150234	Ignition Module	Std pkg 1	Servicing: Mazda - Visit our web catalogue for further information	Type: Pick up Type/terminal: Internal thread Terminals: 5 1: KI1/C 2: KI15/B 3: KI31/Ground 4: G+/ 5: G-/SG
				
150236	Ignition Module	Std pkg 1	Servicing: Acura, Honda - Visit our web catalogue for further information	Type: Amplifier Terminals: 5 1: Input 2: KI15 3: KI1 4: TACH/rpm 5: KI31/Ground
				
150239	Ignition Module	Std pkg 1	Servicing: GM USA, Daewoo - Visit our web catalogue for further information	Type: Amplifier Terminals: 8 1: KI15 2: KI1/C 3: KI31/Ground 4: B(ECU) 5: B(ECU) 6: E(ECU) 7: G+ 8: W-
				
150377	Ignition Module	Std pkg 1	Servicing: Suzuki, Audi, Hyundai, Mitsubishi, Seat, Skoda, VW - Visit our web catalogue for further information	Type: Amplifier Terminals: 3 1: Input 2: KI31/Ground 3: KI1
				

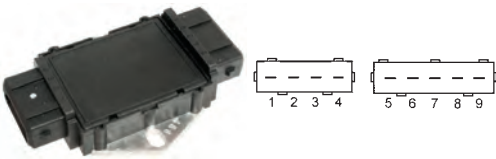
		EL. SPECIFICATIONS	DIMENSIONS	ADDITIONAL SPECIFICATIONS
150378	Ignition Module	Std pkg 1	Servicing: Mitsubishi - Visit our web catalogue for further information	<p>Type: Amplifier</p> <p>Terminals: 5</p> <p>1: KI1/C</p> <p>2: KI15/B</p> <p>3: KI31/Ground</p> <p>4: G+/+</p> <p>5: G-/SG</p>
				
150379	Ignition Module	Std pkg 1	Servicing: BMW, Opel, Alfa Romeo, Citroen, Lancia, Peugeot, Porsche - Visit our web catalogue for further information	<p>Type: Amplifier</p> <p>Terminals: 7</p> <p>1: KI1</p> <p>2: Input</p> <p>3: NC</p> <p>4: KI31/Ground</p> <p>5: NC</p> <p>6: KI1</p> <p>7: Input</p>
				
150380	Ignition Module	Std pkg 1	Servicing: Opel, Vauxhall - Visit our web catalogue for further information	<p>Type: Amplifier</p> <p>Terminals: 4</p> <p>1: KI1</p> <p>2: KI31/Ground</p> <p>3: KI15</p> <p>4: Input</p> <p>Alternativ no.: 150175</p>
<p>w/ bracket.</p> 				
150384	Ignition Module	Std pkg 1	Servicing: Honda - Visit our web catalogue for further information	<p>Type: Amplifier</p> <p>Terminals: 5</p> <p>1: KI31/Ground</p> <p>2: Input</p> <p>3: KI15</p> <p>4: KI1</p> <p>5: RPM out/TD</p>
				
150387	Ignition Module	Std pkg 1	Servicing: Alfa Romeo, Ferrari, Opel, Volvo - Visit our web catalogue for further information	<p>Type: Amplifier</p> <p>Terminals: 7</p> <p>1: KI1</p> <p>2: Input</p> <p>3: KI1</p> <p>4: KI31/Ground</p> <p>5: Input</p> <p>6: KI1</p> <p>7: Input</p>
				
150398	Ignition Module	Std pkg 1	Servicing: Hitachi, Honda - Visit our web catalogue for further information	<p>Type: Pick up</p> <p>Terminals: 5</p> <p>1: Ground</p> <p>2: C+/B</p> <p>3: B+/B2</p> <p>4: TACH/rpm</p> <p>5: C-/C</p>
				
150406	Ignition Module	Std pkg 1	Servicing: Skoda, Audi, Seat, VW - Visit our web catalogue for further information	<p>Type: Amplifier</p> <p>Terminals: 9</p> <p>1: KI1.4</p> <p>2: LI1.3</p> <p>3: KI1.2</p> <p>4: KI1.1</p> <p>5: Input4</p> <p>6: Input3</p> <p>7: KI31</p> <p>8: Input2</p> <p>9: Input1</p>
				

		EL. SPECIFICATIONS	DIMENSIONS	ADDITIONAL SPECIFICATIONS
150409	Ignition Module	Std pkg 1	Servicing: VW, Passat, Audi - Visit our web catalogue for further information	
				Type: Amplifier Terminals: 7 1: KI1.1 2: KI1.2 3: KI1.3 4: Input1 5: Input2 6: KI31 7: Input3
150417	Ignition Module	Std pkg 1	Servicing: Mazda - Visit our web catalogue for further information	
				Type: Pick up Terminals: 6 1: KI1/G 2: KI15/B 3: G+ 4: KI31/Ground 5: W- 6: A
150512	Ignition Module	Std pkg 1	Servicing: Mitsubishi - Visit our web catalogue for further information	
<i>Hall.</i> 				Type: Hall Terminals: 6
ELECTRONIC KITS				
150227	Electronic Ignition Kit	Std pkg 1	Servicing: Audi, Seat, Skoda, VW - Visit our web catalogue for further information	
<i>Does not fit VW w/ Telefunken plant.</i> 		Voltage: 12		Type: Dry Terminals/ignition coil: 2 Terminals/module: 3 Terminals w/thread: Yes
150403	Electronic Ignition Kit	Std pkg 1	Servicing: Opel, Vauxhall - Visit our web catalogue for further information	
		Voltage: 12		Type: Dry Terminals/module: 4
150435	Electronic Ignition Kit	Std pkg 1	Servicing: Audi, Seat, Skoda, VW - Visit our web catalogue for further information	
		Voltage: 12		Type: Dry Terminals/module: 4 Terminals w/thread: Yes
150516	Electronic Ignition Kit	Std pkg 1	Servicing: Ford, Mercedes-Benz, VW - Visit our web catalogue for further information	
		Voltage: 12		Type: Dry Terminals/module: 5

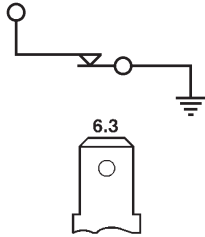
SWITCHES & SENSORS - ENGINE MANAGEMENT
SWITCHES
OIL PRESSURE SWITCHES
180626 Oil Pressure Switch Std pkg 1

 Thread size: M10-1
 cone
 Thread type: mm
 Pressure: 0.3 bar

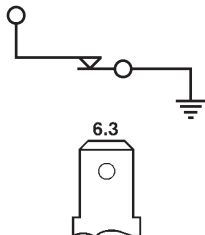
Alternativ no.: 180634

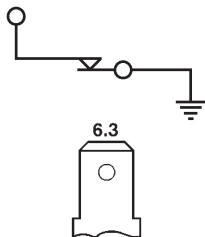
180631 7.0001 Oil Pressure Switch Std pkg 1 Servicing: Fiat, Lancia, Seat - Visit our web catalogue for further information

 Thread size: M12-1.5
 Thread type: mm
 Pressure: 0.3 bar

180634 7.0007 Oil Pressure Switch Std pkg 1 Servicing: Alfa Romeo, Audi, BMW, Rover - Visit our web catalogue for further information

 Thread size: M10-1
 cone
 Thread type: mm
 Pressure: 0.3 bar

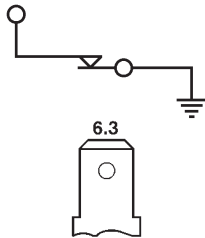
Alternativ no.: 180626

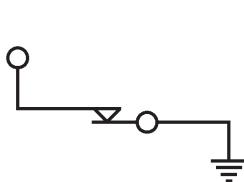
180635 7.0008 Oil Pressure Switch Std pkg 1 Servicing: Alfa Romeo, Audi, Lancia, Seat, Volvo, VW - Visit our web catalogue for further information

Replacing original brown switch.

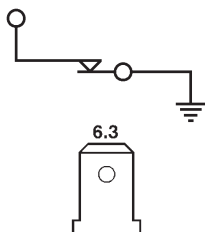
 Thread size: M10-1
 Thread type: mm
 Pressure: 0.3 bar

180636 7.0011 Oil Pressure Switch Std pkg 1 Servicing: Ford, Mazda - Visit our web catalogue for further information

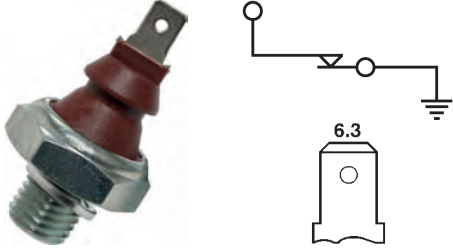
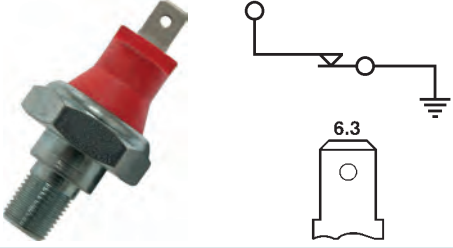
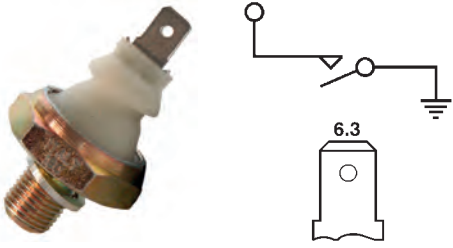
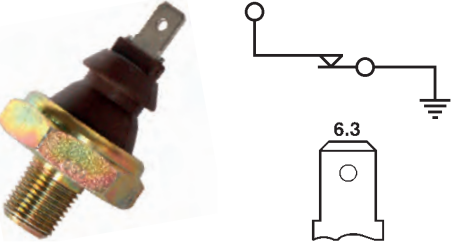
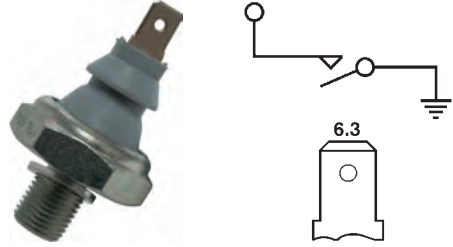
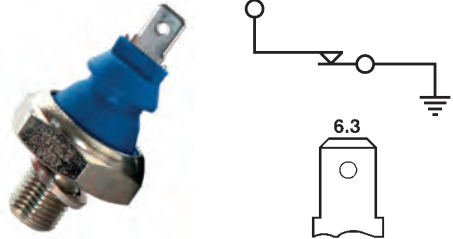
 Thread size: 1/4-18
 NPT cone
 Pressure: 0.3 bar

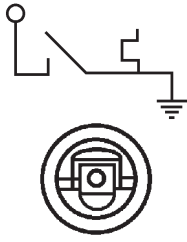
180641 7.0017 Oil Pressure Switch Std pkg 1 Servicing: Acura, Chevrolet, Daewoo, Daihatsu, Ford, Hyundai, Kia, Mazda, Mitsubishi, Suzuki, Toyota, VW - Visit our web catalogue for further information

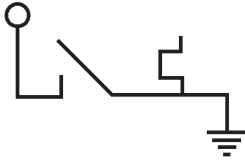
 Thread size: 1/8 GAS
 cone
 Pressure: 0.4 bar

<p>180648 7.0026 Oil Pressure Switch Std pkg 1</p>	<p>Servicing: BMW, Mercedes-Benz, Puch (Steyr-Daimler), Smart (MCC), VW - Visit our web catalogue for further information</p>
<p><i>Replacing original brown switch.</i></p>	
	<p>Thread size: M12-1.5 Thread type: mm Pressure: 0.35 bar</p>
<p>180649 7.0027 Oil Pressure Switch Std pkg 1</p>	<p>Servicing: Austin, Rover - Visit our web catalogue for further information</p>
	<p>Thread size: 1/8-27 NPT cone Pressure: 0.5 bar</p>
<p>180658 7.0045 Oil Pressure Switch Std pkg 1</p>	<p>Servicing: Audi, Seat, VW - Visit our web catalogue for further information</p>
<p><i>Replacing original white switch.</i></p>	
	<p>Thread size: M10-1 Thread type: mm Pressure: 1.8 bar</p>
<p>180660 7.0047 Oil Pressure Switch Std pkg 1</p>	<p>Servicing: Volvo - Visit our web catalogue for further information</p>
	<p>Thread size: 1/8-27 NPT cone Pressure: 0.5 bar</p>
<p>180688 7.0095 Oil Pressure Switch Std pkg 1</p>	<p>Servicing: Audi, Ford, Seat, Skoda, VW - Visit our web catalogue for further information</p>
<p><i>Replacing original brown and grey switch.</i></p>	
	<p>Thread size: M10-1 Thread type: mm Pressure: 0.9 bar</p>
<p>180694 7.0108 Oil Pressure Switch Std pkg 1</p>	<p>Servicing: Audi, Ford, Mercedes-Benz, Renault, Seat, Skoda, Volvo, VW - Visit our web catalogue for further information</p>
<p><i>Replacing original light blue switch.</i></p>	
	<p>Thread size: M10-1 Thread type: mm Pressure: 0.3 bar</p>

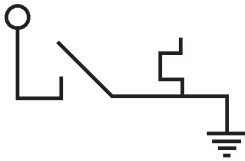
TEMPERATURE SWITCHES
180945 7.4000 Temperature Switch Std pkg 1 Servicing: Fiat, Lancia, Seat - Visit our web catalogue for further information

 Thread size: M16-1.5
 cone
 Thread type: mm
 Working temp.: 115 °C

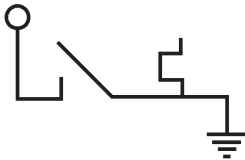
180949 7.4007 Temperature Switch Std pkg 1 Servicing: Audi - Visit our web catalogue for further information

 Thread size: M10-1
 Thread type: mm
 Working temp.: 120 °C

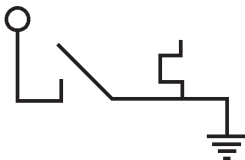

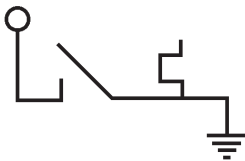



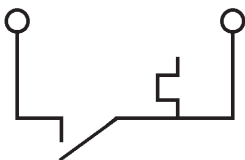



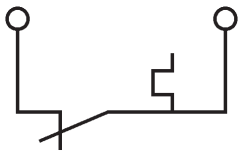

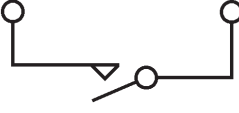
180950 7.4014 Temperature Switch Std pkg 1 Servicing: Citroen, Fiat, Ford, Peugeot - Visit our web catalogue for further information

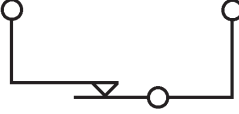
 Thread size: M18-1.5
 Thread type: mm
 Working temp.: 105 °C

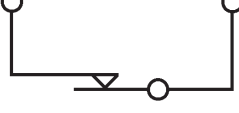
180953 7.4029 Temperature Switch Std pkg 1 Servicing: Citroen, Ford, Peugeot - Visit our web catalogue for further information

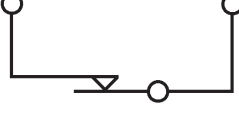
 Thread size: M14-1.25
 Thread type: mm
 Working temp.: 105 °C

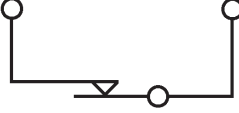
180954 7.4030 Temperature Switch Std pkg 1 Servicing: Citroen, Ford, Peugeot - Visit our web catalogue for further information

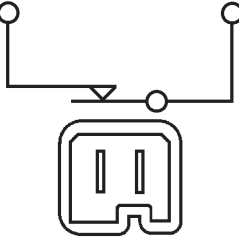
 Thread size: M14-1.25
 Thread type: mm
 Working temp.: 110 °C

180959 7.4042 Temperature Switch Std pkg 1 Servicing: Mercedes-Benz - Visit our web catalogue for further information

 Thread size: M14-1.5
 Thread type: mm
 Working temp.: 110 °C

180985 7.4079 Temperature Switch Std pkg 1 Servicing: Alfa Romeo - Visit our web catalogue for further information

 Thread size: M14-1.5
 Thread type: mm
 Working temp.: 45 °C

180986 7.4080 Temperature Switch Std pkg 1		Servicing: Seat, VW - Visit our web catalogue for further information	
			Thread size: M10-1 Thread type: mm Working temp.: 120 °C
BRAKE LIGHT SWITCHES			
MECHANICAL			
180008 Brake Light Switch Std pkg 1			
			Type: Mechanical
180009 Brake Light Switch Std pkg 1			
			Type: Mechanical
180726 7.1000 Brake Light Switch Std pkg 1		Servicing: Alfa Romeo, Fiat, Iveco, Lada, Lancia, Polski-Fiat, Seat, Skoda, Zastava - Visit our web catalogue for further information	
			Thread size: M12-1.5 Thread type: mm Type: Mechanical
180731 7.1007 Brake Light Switch Std pkg 1		Servicing: Citroen, Peugeot, Talbot - Visit our web catalogue for further information	
			Thread size: M10-1 Type: Mechanical
180734 7.1014 Brake Light Switch Std pkg 1		Servicing: BMW, Lada, Mercedes-Benz, Opel, Saab, Volvo - Visit our web catalogue for further information	
			Thread size: M12-1 Thread type: mm Type: Mechanical
180785 7.1091 Brake Light Switch Std pkg 1		Servicing: Citroen, Fiat, Lancia, Peugeot - Visit our web catalogue for further information	
			Type: Mechanical

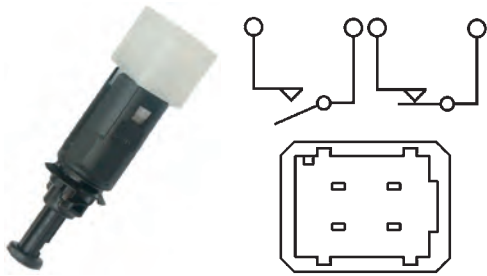
181367 7.1149 Brake Light Switch Std pkg 1 Servicing: Nissan, Renault - Visit our web catalogue for further information

Self-adjustable plunger.



Type: Mechanical

181369 7.1151 Brake Light Switch Std pkg 1 Servicing: Audi, Ford, Seat, Skoda, VW - Visit our web catalogue for further information

Self-adjustable plunger.

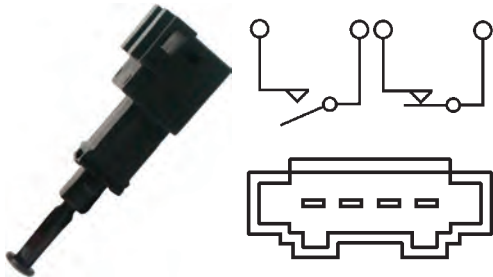

Type: Mechanical

HYDRAULIC

180790 7.1101 Brake Light Switch Std pkg 1 Servicing: Austin, Fiat, Ford, Jaguar, MAN, MG - Visit our web catalogue for further information

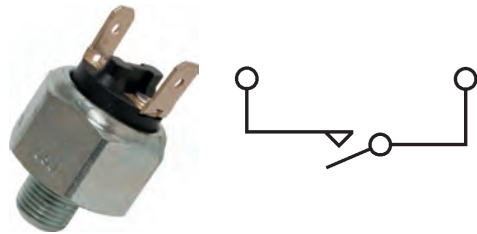

Thread size: 1/8-27
NPT cone

Type: Hydraulic

180791 7.1102 Brake Light Switch Std pkg 1 Servicing: Audi, Porsche, Skoda, VW - Visit our web catalogue for further information

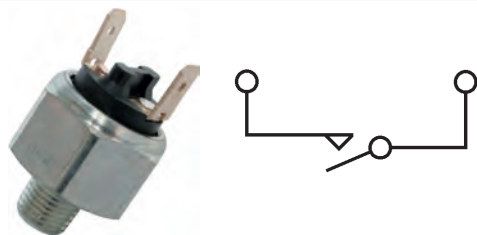

Thread size: M10-1
cone
Thread type: mm

Type: Hydraulic

REVERSE LIGHT SWITCHES

181147 7.6007 Reverse Light Switch Std pkg 1 Servicing: Ford, VW - Visit our web catalogue for further information



















Thread type: M14-1.5





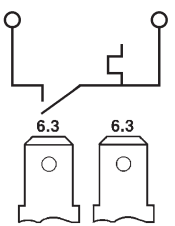

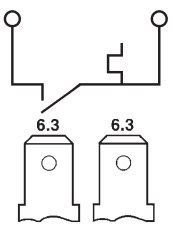

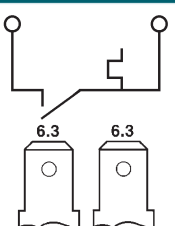

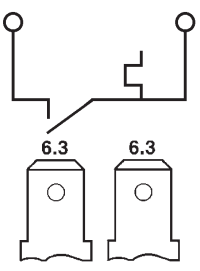
181148 7.6009 Reverse Light Switch Std pkg 1 Servicing: Austin, Rover, Seat, VW - Visit our web catalogue for further information

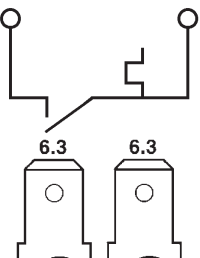

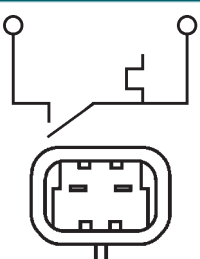
Thread type: M12-1.5

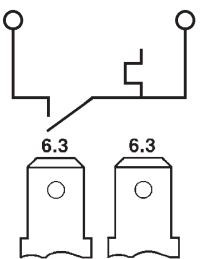
EL. SPECIFICATIONS		DIMENSIONS	ADDITIONAL SPECIFICATIONS
181150	7.6011 Reverse Light Switch Std pkg 1	Servicing: Opel - Visit our web catalogue for further information	Thread type: M12-1.5
			
181156	7.6019 Reverse Light Switch Std pkg 1	Servicing: Citroen, Fiat, Talbot - Visit our web catalogue for further information	Thread type: M12-1
			
181158	7.6021 Reverse Light Switch Std pkg 1	Servicing: Skoda - Visit our web catalogue for further information	Thread type: M14-1
			
181182	7.6073 Reverse Light Switch Std pkg 1	Servicing: Alfa Romeo, Chevrolet, Daewoo, Fiat, Lancia, Mercedes-Benz, MG, Mini, Opel, Rover, Saab, Suzuki - Visit our web catalogue for further information	Thread type: M12-1.5
			
181183	7.6075 Reverse Light Switch Std pkg 1		Thread type: M16-2
			
181191	7.6096 Reverse Light Switch Std pkg 1	Servicing: DAF, Mercedes-Benz, Mitsubishi, Nissan, Opel, Renault, Volvo - Visit our web catalogue for further information	Thread type: M14-1.5
			
181194	7.6099 Reverse Light Switch Std pkg 1	Servicing: Audi, Citroen, Fiat, Lancia, Land Rover, Mini, Nissan, Peugeot, Rover, Skoda, VW - Visit our web catalogue for further information	Thread type: M14-1.5
			

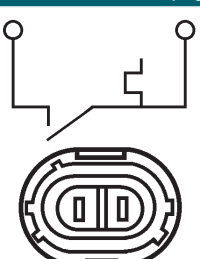
		EL. SPECIFICATIONS	DIMENSIONS	ADDITIONAL SPECIFICATIONS
181197	7.6102 Reverse Light Switch Std pkg 1	Servicing: Iveco - Visit our web catalogue for further information		
			Thread type: M27-1 Thread type 2: M18-1.5	
181201	7.6108 Reverse Light Switch Std pkg 1	Servicing: Citroen, Fiat, Peugeot - Visit our web catalogue for further information		
			Thread type: M14-1.5	
181212	7.6125 Reverse Light Switch Std pkg 1	Servicing: Rover, Seat, Skoda, VW - Visit our web catalogue for further information		
			Thread type: M12-1.5	
181456	7.6215 Reverse Light Switch Std pkg 1	Servicing: Audi, Ford, Seat, Skoda, VW - Visit our web catalogue for further information		
			Thread type: M12-1.5	
THERMO SENSOR SWITCHES				
181001	7.5000 Thermo Sensor Switch Std pkg 1	Servicing: Alfa Romeo, Fiat, Lada, Saab, Seat, Talbot, Zastava - Visit our web catalogue for further information		
			Thread size: M22-1.5 Thread type: mm Working temp.: 92 °C Working temp. 2: 87 °C	
181005	7.5004 Thermo Sensor Switch Std pkg 1	Servicing: Peugeot - Visit our web catalogue for further information		
			Thread size: M22-1.5 Thread type: mm Working temp.: 82 °C Working temp. 2: 67 °C	
181008	7.5007 Thermo Sensor Switch Std pkg 1	Servicing: Citroen, Ford, Peugeot, Renault, Talbot - Visit our web catalogue for further information		
			Thread size: M22-1.5 Thread type: mm Working temp.: 87 °C Working temp. 2: 77 °C	

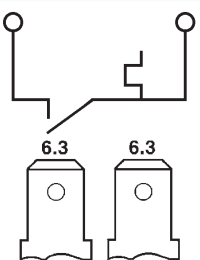
<p>181009 7.5008 Thermo Sensor Switch Std pkg 1</p>  	<p>Servicing: Alfa Romeo, Peugeot, Renault - Visit our web catalogue for further information</p>	<p>Thread size: M22-1.5 Thread type: mm Working temp.: 85 °C Working temp. 2: 75 °C</p>	
<p>181015 7.5018 Thermo Sensor Switch Std pkg 1</p>  	<p>Servicing: Citroen - Visit our web catalogue for further information</p>	<p>Thread size: M22-1.5 Thread type: mm Working temp.: 86 °C Working temp. 2: 81 °C</p>	
<p>181021 7.5031 Thermo Sensor Switch Std pkg 1</p>  	<p>Servicing: Alfa Romeo, Fiat, Innocenti, Iveco, Lancia - Visit our web catalogue for further information</p>	<p>Thread size: M22-1.5 Thread type: mm Working temp.: 92 °C Working temp. 2: 87 °C</p>	
<p>181034 7.5063 Thermo Sensor Switch Std pkg 1</p>  	<p>Servicing: BMW, Opel, Volvo - Visit our web catalogue for further information</p>	<p>Thread size: M14-1.5 Thread type: mm Working temp.: 95 °C Working temp. 2: 90 °C</p>	
<p>181064 7.5128 Thermo Sensor Switch Std pkg 1</p>  	<p>Servicing: Ford, Mercedes-Benz, Opel, Renault - Visit our web catalogue for further information</p>	<p>Thread size: M22-1.5 Thread type: mm Working temp.: 92 °C Working temp. 2: 82 °C</p>	
<p>181073 7.5142 Thermo Sensor Switch Std pkg 1</p>  	<p>Servicing: Volvo - Visit our web catalogue for further information</p>	<p>Thread size: M14-1.5 Thread type: mm Working temp.: 72 °C Working temp. 2: 67 °C</p>	

181076 7.5145 Thermo Sensor Switch Std pkg 1 Servicing: Citroen, Fiat, Lancia, Opel, Peugeot - Visit our web catalogue for further information

Replacing original switch w/ yellow ring.

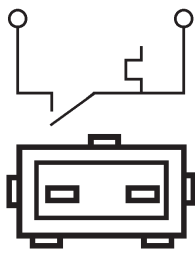

Thread size: M22-1.5
Thread type: mm
Working temp.: 97 °C
Working temp. 2: 92 °C

181077 7.5146 Thermo Sensor Switch Std pkg 1 Servicing: Volvo - Visit our web catalogue for further information

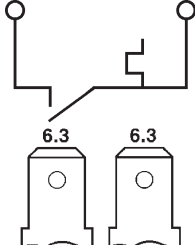

Thread size: M14-1.5
Thread type: mm
Working temp.: 87 °C
Working temp. 2: 82 °C

181088 7.5182 Thermo Sensor Switch Std pkg 1 Servicing: Mercedes-Benz, Opel, Vauxhall - Visit our web catalogue for further information

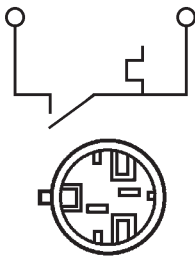

Thread size: M22-1.5
Thread type: mm
Working temp.: 100 °C
Working temp. 2: 95 °C

181089 7.5187 Thermo Sensor Switch Std pkg 1 Servicing: Citroen, Fiat, Iveco, Lancia, Peugeot - Visit our web catalogue for further information

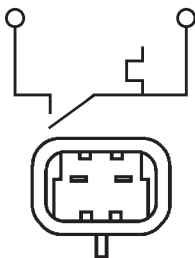

Thread size: M22-1.5
Thread type: mm
Working temp.: 92 °C
Working temp. 2: 87 °C

DOUBLE FAN OR TWO SPEED MOTORS

181121 7.5626 Thermo Sensor Switch Std pkg 1 Servicing: Audi, VW - Visit our web catalogue for further information

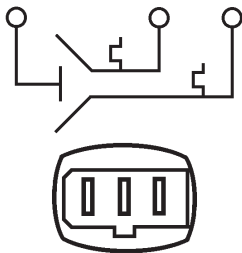

Thread size: M22-1.5
Thread type: mm
Working temp.: 87-77 °C
Working temp. 2: 92-82 °C

Double fan: Yes
2 speed: Yes

181126 7.5635 Thermo Sensor Switch Std pkg 1 Servicing: Audi, Opel, Seat, Skoda, VW - Visit our web catalogue for further information

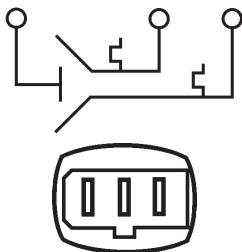

Thread size: M22-1.5
Thread type: mm
Working temp.: 95-85 °C
Working temp. 2: 102-92 °C

Double fan: Yes
2 speed: Yes

SENSORS

TEMPERATURE SENSORS

WATER

160786 Temp. Transmitter Std pkg 1 Servicing: HC-CARGO 160699, 160778



Voltage: 12-24

Thread size: 1/8 NPTF

180804 7.3000 Temperature Sensor Std pkg 1

For water.



Thread size: M16-1.5 cone
Thread type: mm

180808 7.3005 Temperature Sensor Std pkg 1

For water.



Thread size: 1/8-27 NPT cone

180820 7.3028 Temperature Sensor Std pkg 1

Replace original yellow sensor. For water.



Thread size: 1/8-27 NPT cone

180839 7.3073 Temperature Sensor Std pkg 1

For water.



Thread size: M10-1

180848 7.3086 Temperature Sensor Std pkg 1

Replacing original black sensor. For water.



180883 7.3146 Temperature Sensor Std pkg 1

Replacing original black and yellow sensor. For water.

180893 7.3165 Temperature Sensor Std pkg 1

Replacing original black sensor. For water.

 Thread size: 1/8-27
NPT

181400 7.3258 Temperature Sensor Std pkg 1

Replace original green sensor. For water.

ENGINE
180861 7.3101 Temperature Sensor Std pkg 1

Replacing original blue sensor. For engine.

 Thread size: M16-1
Thread type: mm

180875 7.3128 Temperature Sensor Std pkg 1

Replacing original blue sensor. For engine.

 Thread size: M12-1.5
Thread type: mm

180905 7.3191 Temperature Sensor Std pkg 1

Replacing original white sensor. For engine.

 Thread size: M12-1.5
Thread type: mm

181373 7.3308 Temperature Sensor Std pkg 1

For motor.

 Thread size: M14-1.25
 Thread type: mm

181395 7.3239 Temperature Sensor Std pkg 1

For motor.

 Thread size: M12-1.5
 Thread type: mm

OIL PRESSURE SENSORS

160787 Oil Pressure Sensor Std pkg 1 Servicing: HC-CARGO 160700, 160779

Voltage: 12-24

Thread size: 1/8 NPTF

TIMING SENSORS

CRANKSHAFTS

150340 Crankshaft Position Sensor Std pkg 1

Ohm: 240

150354 Crankshaft Position Sensor Std pkg 1

Ohm: 530

150404 Crankshaft Position Sensor Std pkg 1

Ohm: 250

150414 Crankshaft Position Sensor Std pkg 1

Ohm: 250

150451 Crankshaft Position Sensor Std pkg 1

Ohm: 900

150468 Crankshaft Position Sensor Std pkg 1

Ohm: 900

Sensor dia.: 20.2 mm

Plug: w/

150470 Crankshaft Position Sensor Std pkg 1

Ohm: 900

CAMSHAFTS

150496 Camshaft Position Sensor Std pkg 1 Servicing: Volvo, Renault - Visit our web catalogue for further information

Hall effect.

LAMBDA SENSORS







UNIVERSAL

181584 Universal Lambda Sensor Std pkg 1 Servicing: Audi, BMW, Daewoo, Daihatsu, De Lorean, Fiat, Honda, Hyundai, Jaguar, Kia, Lancia, Lotus, Mazda, Mercedes-Benz - Visit our web catalogue for further information

 Sensor dia.: 21 mm
 Thread size: M18-1.5
 Thread type: mm

 Type: Universal, Zirconia
 Colour: Black
 No./wires: 1
 Plug: w/o

		EL. SPECIFICATIONS	DIMENSIONS	ADDITIONAL SPECIFICATIONS
181585	Universal Lambda Sensor	Std pkg 1	Servicing: Alfa Romeo, Audi, Autobianchi, BMW, Chevrolet, Daimler, Ferrari, Fiat, Ford, Hyundai, Isuzu, Jaguar, Kia, Lancia, Mazda - Visit our web catalogue for further information	
		Watt: 12	Sensor dia.: 21.8 mm Thread size: M18-1.5 Thread type: mm	Connection: Pre heating +, Pre heating -, Signal + Type: Universal, Zirconia Colour: Black - White - White No./wires: 3 Plug: w/o
181586	Universal Lambda Sensor	Std pkg 1	Servicing: BMW, Citroen, Fiat, Jeep, Mazda, Mercedes-Benz, Peugeot, Renault, Seat, Skoda, Volvo, VW - Visit our web catalogue for further information	
		Watt: 18	Sensor dia.: 21.8 mm Thread size: M18-1.5 Thread type: mm	Connection: Pre heating +, Pre heating -, Signal +, Signal - Type: Universal, Zirconia Colour: Black - White - White - Grey No./wires: 4 Plug: w/o
181587	Universal Lambda Sensor	Std pkg 1	Servicing: Audi, Chrysler, Dodge, Fiat, Jeep, Mercedes-Benz, Nissan, Opel, Saab, Seat, Suzuki, Vauxhall, Volvo, VW - Visit our web catalogue for further information	
		Watt: 18	Sensor dia.: 21.8 mm Thread size: M18-1.5 Thread type: mm	Connection: Pre heating +, Pre heating -, Signal + Type: Universal, Zirconia Colour: Black - White - White No./wires: 3 Plug: w/o
181588	Universal Lambda Sensor	Std pkg 1	Servicing: Alpina, Audi, Bentley, BMW, Citroen, Daewoo, Ferrari, Ford, Lada, Land Rover, Mazda, Mercedes-Benz, Opel, Peugeot - Visit our web catalogue for further information	
		Watt: 18	Sensor dia.: 21.8 mm Thread size: M18-1.5 Thread type: mm	Connection: Pre heating +, Pre heating -, Signal +, Signal - Type: Universal, Zirconia Colour: Black - White - White - Grey No./wires: 4 Plug: w/o
181589	Universal Lambda Sensor	Std pkg 1	Servicing: Alfa Romeo, Austin, BMW, Chrysler, Citroen, Ferrari, Fiat, Ford, Honda, Lancia, Land Rover, Mazda, Mercedes-Benz, MG - Visit our web catalogue for further information	
		Watt: 12	Sensor dia.: 21.8 mm Thread size: M18-1.5 Thread type: mm	Connection: Pre heating +, Pre heating -, Signal +, Signal - Type: Universal, Zirconia Colour: Black - White - White - Grey No./wires: 4 Plug: w/o
181590	Universal Lambda Sensor	Std pkg 1	Servicing: Aston Martin, Audi, BMW, Chevrolet, Chrysler, Citroen, Dacia, Daihatsu, Dodge, Ferrari, Fiat, Ford, Honda, Hyundai - Visit our web catalogue for further information	
		Watt: 12	Sensor dia.: 21.8 mm Thread size: M18-1.5 Thread type: mm	Connection: Pre heating +, Pre heating -, Signal +, Signal - Type: Universal, Zirconia Colour: Black - White - White - Grey No./wires: 4 Plug: w/o

			EL. SPECIFICATIONS	DIMENSIONS	ADDITIONAL SPECIFICATIONS
181591	Universal Lambda Sensor	Std pkg 1	Servicing: Alfa Romeo, Audi, Bentley, BMW, Cadillac, Chevrolet, Citroen, Daewoo, Daihatsu, Fiat, Ford, Honda, Hyundai, Jeep, Kia - Visit our web catalogue for further information		
			Watt: 7	Sensor dia.: 17.6 mm Thread size: M18-1.5 Thread type: mm	Connection: Pre heating +, Pre heating -, Signal +, Signal - Type: Universal, Titania Colour: Black - White - White - Grey No./wires: 4 Plug: w/o
181592	Universal Lambda Sensor	Std pkg 1	Servicing: Abarth, Alfa Romeo, Audi, Cadillac, Chrysler, Citroen, Dacia, Ferrari, Fiat, Ford, Honda, Lancia, Land Rover - Visit our web catalogue for further information		
			Watt: 7	Sensor dia.: 17.6 mm Thread size: M18-1.5 Thread type: mm	Connection: Pre heating +, Pre heating -, Signal +, Signal - Type: Universal, Titania Colour: Black - White - White - Grey No./wires: 4 Plug: w/o
ACCESSORIES					
180526	Gasket/Flange	Std pkg 1	ID/threaded hole: M18		
					
AIR MASS METERS					
181494	Air Mass Sensor	Std pkg 1	Servicing: GM, VW, Alfa Romeo, Fiat, Lancia, Opel, Vauxhall - Visit our web catalogue for further information		
					
181495	Air Mass Sensor	Std pkg 1	Servicing: Toyota, GM, Alfa Romeo, Ferrari, Fiat, Honda, Lada, Lancia, Opel, Rover, Vauxhall, Volvo - Visit our web catalogue for further information		
					
181500	Air Mass Sensor	Std pkg 1	Servicing: Landrover, Daewoo, Ssang Yong, BMW, Mercedes-Benz - Visit our web catalogue for further information		
					



Assortments

Edition 2018/2019

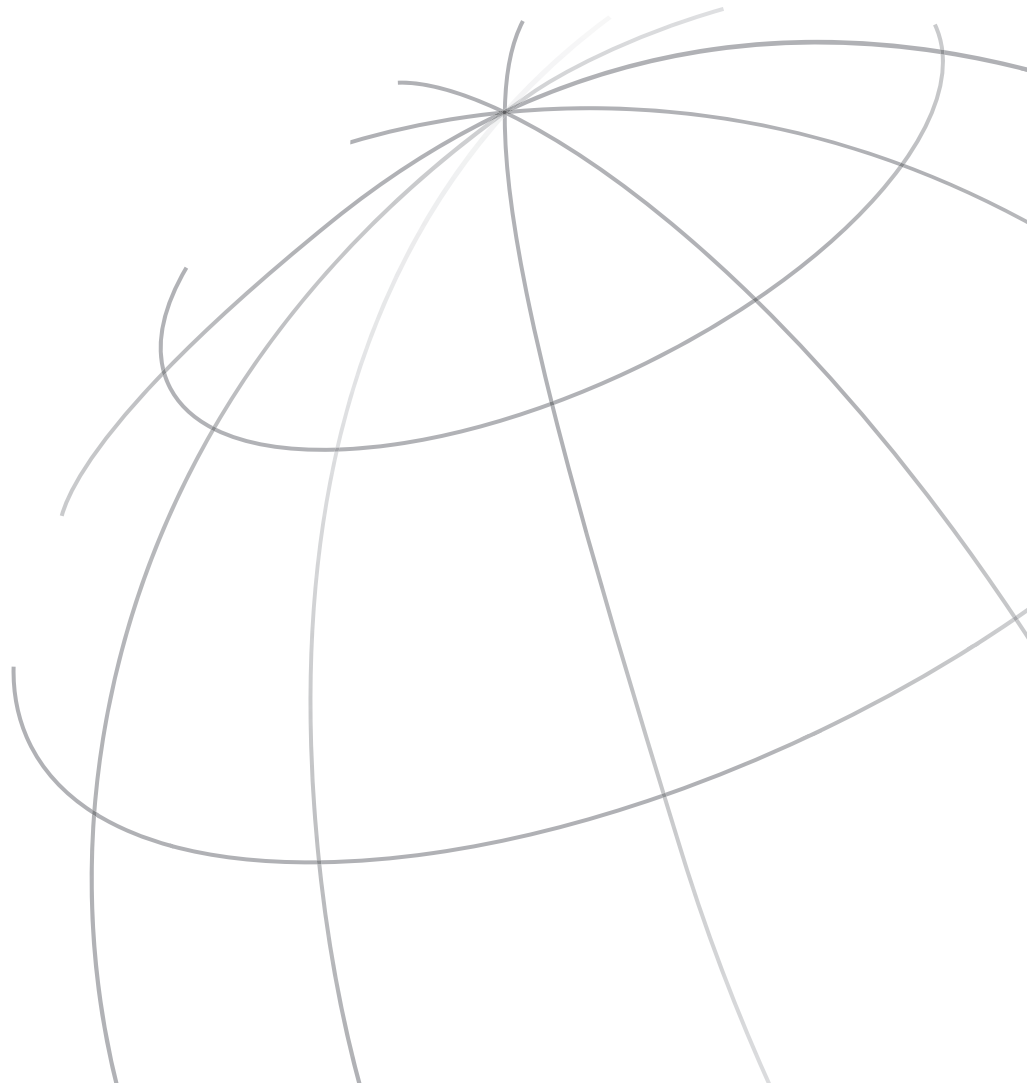

Thermal Washers
806011

	Qty.		Qty.
080296	10	080440	10
080424	10	080441	10
080425	10	080442	10
080426	10	080443	10
080427	10	080444	10
080428	10	080446	10
080430	10	080447	10
080431	10	080448	10
080432	10	080449	10
080433	10	080450	10
080434	10	080452	10
080435	10	080453	10
080436	10	080454	10
080437	10	080456	10
080438	10	080688	10
080439	10	081115	10

Ring Nipples & Hose Sleeves
806015

	Qty.		Qty.
080237	5	080263	10
080238	5	080264	10
080239	5	080265	10
080240	5		
080241	5		
080242	5		
080243	5		
080245	5		
080246	5		
080247	5		
080259	10		
080260	10		
080261	10		
080262	10		

Hollow Screws & Hose Nipples
806020

	Qty.		Qty.
080003	3	080255	10
080237	3	080256	10
080238	3	080257	10
080239	3	080258	10
080240	3		
080241	3		
080242	3		
080243	3		
080246	3		
080247	3		
080251	5		
080252	5		
080253	5		
080254	5		

Glow Plugs
806030

	Qty.
100261	4
100335	4
100515	4
100527	4
100531	4
100532	4
100537	4
100538	4
100545	4
100555	4
100557	4
100563	4
100592	4
100593	4





Workshop Consumables

Edition 2018/2019



CRIMP TERMINALS

INSULATED

RED
0.25-1.6 mm²

BLUE
1-2.6 mm²

YELLOW
2.6-6.6 mm²

FEMALE SPADE



HC-CARGO	Std pkg	Type	ID	Colour
190049	Pkg. 100	2.8 mm	1.7 mm	Red
192795	Pkg. 100	2.8 mm	2.3 mm	Blue
190045	Pkg. 100	4.7 mm	1.7 mm	Red
192825	Pkg. 100	4.7 mm	2.3 mm	Blue
190024	Pkg. 50	6.3 mm	1.7 mm	Yellow
190022	Pkg. 100	6.3 mm	1.7 mm	Red
190020	Pkg. 100	6.3 mm	2.3 mm	Blue
190041	Pkg. 100	8 mm	2.3 mm	Blue
190048	Pkg. 50	9.5 mm	3.4 mm	Yellow

FULLY INSULATED



HC-CARGO	Std pkg	Type	ID	Colour
192226	Pkg. 100	4.7 mm	1.7 mm	Red
190985	Pkg. 100	6.3 mm	1.7 mm	Red
190046	Pkg. 100	6.3 mm	2.3 mm	Blue
192036	Pkg. 50	6.3 mm	3.4 mm	Yellow

FEMALE SPADE & PIGGY BACK SPADE



HC-CARGO	Std pkg	Type	ID	Colour
190025	Pkg. 100	6.3 mm	1.7 mm	Red
190026	Pkg. 100	6.3 mm	2.3 mm	Blue

SPADE



HC-CARGO	Std pkg	Width	ID	Colour
192449	Pkg. 100	2.8 mm	1.7 mm	Red
190019	Pkg. 100	6.3 mm	1.7 mm	Red
190016	Pkg. 100	6.3 mm	2.3 mm	Blue
191191	Pkg. 50	6.3 mm	3.4 mm	Yellow

FEMALE BULLET







HC-CARGO	Std pkg	Width	ID	Colour
190017	Pkg. 100	3.9 mm	1.7 mm	Red
190018	Pkg. 100	4.9 mm	2.3 mm	Blue
190050	Pkg. 50	4.9 mm	3.4 mm	Yellow

MALE BULLET



HC-CARGO	Std pkg	Width	ID	Colour
190021	Pkg. 100	4 mm	1.7 mm	Red
190023	Pkg. 100	5 mm	2.3 mm	Blue
190051	Pkg. 50	5 mm	3.4 mm	Yellow

BUTT CONNECTOR					
	HC-CARGO	Std pkg	Width	ID	Colour
	190028	Pkg. 100	4.1 mm	1.7 mm	Red
	190001	Pkg. 100	4.8 mm	2.3 mm	Blue
	190030	Pkg. 50	6.7 mm	3.4 mm	Yellow
RING					
	HC-CARGO	Std pkg	Bolt size	ID	Colour
	190038	Pkg. 100	3 mm	1.7 mm	Red
	190257	Pkg. 100	3 mm	2.3 mm	Blue
	190029	Pkg. 100	4 mm	2.3 mm	Blue
	190027	Pkg. 100	4 mm	1.7 mm	Red
	190031	Pkg. 100	5 mm	1.7 mm	Red
	190032	Pkg. 100	5 mm	2.3 mm	Blue
	190033	Pkg. 50	5 mm	3.5 mm	Yellow
	190015	Pkg. 100	6 mm	1.7 mm	Red
	190034	Pkg. 100	6 mm	2.3 mm	Blue
	190035	Pkg. 50	6 mm	3.5 mm	Yellow
	190039	Pkg. 100	8 mm	2.3 mm	Blue
	190255	Pkg. 50	8 mm	3.5 mm	Yellow
	192352	Pkg. 100	8 mm	1.7 mm	Red
	190042	Pkg. 50	10 mm	3.5 mm	Yellow
	192353	Pkg. 100	10 mm	1.7 mm	Red
	192354	Pkg. 100	10 mm	2.3 mm	Blue
191515	Pkg. 50	12 mm	3.5 mm	Yellow	
FORK					
	HC-CARGO	Std pkg	Type	ID	Colour
	191501	Pkg. 100	2 mm	3.5 mm	Red
	191067	Pkg. 100	4 mm	4.9 mm	Blue
	190973	Pkg. 100	4 mm	3.7 mm	Red
	190037	Pkg. 100	5.3 mm	2.3 mm	Blue
	192142	Pkg. 50	6.4 mm	3.4 mm	Yellow
	192950	Pkg. 100	8.3 mm	3.5 mm	Yellow
FORK W/ FLANGE					
	HC-CARGO	Std pkg	Width	ID	Colour
	192371	Pkg. 100	5 mm	2.3 mm	Blue
PIN					
	HC-CARGO	Std pkg	Width	ID	Colour
	190974	Pkg. 100	1.9 mm	1.7 mm	Red
	190952	Pkg. 100	1.9 mm	2.3 mm	Blue
	190953	Pkg. 50	2.8 mm	3.4 mm	Yellow

TERMINATORS HEAT-SHRINKABLE W/SOLDER

FEMALE SPADE, FULLY INSULATED

	HC-CARGO	Std pkg	Width	Crimp temp.	Temp. area	Colour
	193244	Pkg. 25	3.2 mm	150 °C	10-105 °C	Red
	193245	Pkg. 25	5 mm	150 °C	10-105 °C	Red
	191697	Pkg. 25	6.6 mm	150 °C	10-105 °C	Red
	191698	Pkg. 25	6.6 mm	150 °C	10-105 °C	Blue

MALE

	HC-CARGO	Std pkg	Width	Crimp temp.	Temp. area	Colour
	191699	Pkg. 25	6.3 mm	150 °C	10-105 °C	Red
	191700	Pkg. 25	6.3 mm	150 °C	10-105 °C	Blue

BUTT CONNECTOR

	HC-CARGO	Std pkg	Width	Crimp temp.	Temp. area	Colour
	191010	Pkg. 100	6.9 mm	min. +85	-55 - +125 °C	Blue
	191009	Pkg. 100	6 mm	min. +85	-55 - +125 °C	Red
	191011	Pkg. 100	8.6 mm	min. +85	-55 - +125 °C	Yellow

RING

	HC-CARGO	Std pkg	Width	Crimp temp.	Temp. area	Colour
	191685	Pkg. 25	4.2 mm	150 °C	10-105 °C	Blue
	191682	Pkg. 25	4.2 mm	150 °C	10-105 °C	Red
	191683	Pkg. 25	5.2 mm	150 °C	10-105 °C	Red
	191686	Pkg. 25	5.2 mm	150 °C	10-105 °C	Blue
	191689	Pkg. 25	5.2 mm	150 °C	10-105 °C	Yellow
	191690	Pkg. 25	6.3 mm	150 °C	10-105 °C	Yellow
	191684	Pkg. 25	6.4 mm	150 °C	10-105 °C	Red
	191687	Pkg. 25	6.5 mm	150 °C	10-105 °C	Blue
	191688	Pkg. 25	8.5 mm	150 °C	10-105 °C	Blue
	191691	Pkg. 25	8.5 mm	150 °C	10-105 °C	Yellow
	191692	Pkg. 25	10.5 mm	150 °C	10-105 °C	Yellow

FORK

	HC-CARGO	Std pkg	Width	Crimp temp.	Temp. area	Colour
	191693	Pkg. 25	4.2 mm	150 °C	10-105 °C	Red
	191694	Pkg. 25	4.2 mm	150 °C	10-105 °C	Blue
	191696	Pkg. 25	5.2 mm	150 °C	10-105 °C	Yellow
	191695	Pkg. 25	5.2 mm	150 °C	10-105 °C	Blue

FEMALE BULLET

	HC-CARGO	Std pkg	Width	Crimp temp.	Temp. area	Colour
	193248	Pkg. 25	4 mm	min. +85 °C	-55 - +125 °C	Red
	193247	Pkg. 25	5 mm	min. +85 °C	-55 - +125 °C	Blue

HEAT-SHRINCABLE W/GLUE						
SOLDER SLEEVE						
	HC-CARGO	Std pkg	Width	Crimp temp.	Temp. area	Colour
	193237	Pkg. 25	1.7 mm	min. +85 °C	-55 - +125 °C	Transparent
	193242	Pkg. 25	2.7/4.5 mm	min. +85 °C	-55 - +125 °C	Red/Blue
	191701	Pkg. 25	2.7 mm	min. +85 °C	-55 - +125 °C	Red
	191702	Pkg. 25	4.5 mm	min. +85 °C	-55 - +125 °C	Blue
	193243	Pkg. 25	4.5/6 mm	min. +85 °C	-55 - +125 °C	Yellow/blue
	191703	Pkg. 25	6 mm	min. +85 °C	-55 - +125 °C	Yellow
MULTIWIRE SPLICE						
	HC-CARGO	Std pkg	Width	Crimp temp.	Temp. area	Colour
	191704	Pkg. 5	3.1 mm	min. +85 °C	-55 - +125 °C	Green
	191708	Pkg. 5	3.6 mm	min. +85 °C	-55 - +125 °C	Green
	191705	Pkg. 5	3.9 mm	min. +85 °C	-55 - +125 °C	Red
	191713	Pkg. 5	3.9 mm	min. +85 °C	-55 - +125 °C	Green
	191709	Pkg. 5	5 mm	min. +85 °C	-55 - +125 °C	Red
	191706	Pkg. 5	5.35 mm	min. +85 °C	-55 - +125 °C	Blue
	191710	Pkg. 5	7.5 mm	min. +85 °C	-55 - +125 °C	Blue
	191711	Pkg. 5	9.4 mm	min. +85 °C	-55 - +125 °C	Yellow
NON INSULATED						
MALE FLAT SPADE						
	HC-CARGO	Std pkg	Width	Cable size	Non return tag	Type
	192089	Pkg. 100	1.5 mm	1-1.5 mm ²	w/o	Male, Super Seal Connector
	192410	Pkg. 100	1.8 mm	0.5-1.25 mm ²	w/o	Male, Type 070 M280
	192528	Pkg. 100	2.3 mm	0.5-1.25 mm ²	w/	Male, MT- serie 090
	192645	Pkg. 100	2.3 mm	0.5-1.25 mm ²	w/	Male, TS sealed-serie
	192217	Pkg. 50	2.7 mm	0.5-1 mm ²	w/	Male, Micro Timer II
	192174	Pkg. 100	2.8 mm	0.35-1 mm ²	w/	Male, Junior Timer
	192503	Pkg. 100	2.8x0.8 mm	0.5-1 mm ²	w/	Male, Junior Power Timer
	191681	Pkg. 50	2.8 mm	0.5-1 mm ²	w/	<i>Universal. For car radio</i> Male, M280 DIN norm: 46343
	192240	Pkg. 100	2.8 mm	0.5-1.5 mm ²	w/o	Male, Mark II
	192373	Pkg. 50	2.8 mm	1-2.5 mm ²	w/o	<i>Single Wire Seal: HC-CARGO 192375.</i> Male, Metripack M280

	HC-CARGO	Std pkg	Width	Cable size	Non return tag	Type
	191807	Pkg. 100	3 mm	1-3 mm ²	w/	Male, MIC I
	191129	Pkg. 100	4.7 mm	0.5-1.5 mm ²	w/	Male, Flat For insulator For multiplug
	192156	Pkg. 100	5 mm	0.5-1 mm ²	w/	Male, Junior Power Timer
	192157	Pkg. 100	5 mm	1.5-2.5 mm ²	w/	Male, Junior Power Timer
	191549	Pkg. 100	6.3 mm	0.5-1 mm ²	w/	Male, Flat For insulator For multiplug
	192380	Pkg. 50	6.3 mm	0.5-2 mm ²	w/	Male, Flat Tin plated Japanese type For insulator For multiplug
	191415	Pkg. 100	6.3 mm	1-2.5 mm ²	w/o	Male, Flat For insulator
	190270	Pkg. 100	6.3 mm	1-2.5 mm ²	w/	Male, Flat For insulator For multiplug
	191028	Pkg. 100	6.3 mm	4-6 mm ²	w/	Male, Flat Tin plated For insulator For multiplug



FEMALE SPADE

	HC-CARGO	Std pkg	Width	Cable size	Non return tag	Type
	192786	Pkg. 100	1 mm	0.3-0.5 mm ²	w/o	Female, Type 040 Tin plated
	192090	Pkg. 100	1.5 mm	1-1.5 mm ²	w/o	Female, Super Seal Connector
	192529	Pkg. 100	2.3 mm	0.5-1.25 mm ²	w/	Female, MT- serie 090
	192646	Pkg. 100	2.3 mm	0.5-1.25 mm ²	w/	Female, TS sealed-serie, 090 terminal
	191083	Pkg. 100	2.8 mm	0.5-1 mm ²	w/	Female, Flat For multiplug
	192411	Pkg. 100	2.8 mm	0.5-1.25 mm ²	w/o	Female, Type 070 F280
	192239	Pkg. 100	2.8 mm	0.5-1.5 mm ²	w/o	For tail lamps. Female, Mark II
	192374	Pkg. 50	2.8 mm	1-2.5 mm ²	w/o	Single Wire Seal: HC-CARGO 192375. Female, Metripack F280







	HC-CARGO	Std pkg	Width	Cable size	Non return tag	Type
	191806	Pkg. 100	3 mm	1-3 mm ²	w/	Female, MIC I
	192140	Pkg. 50	3.3 mm	0.5-1 mm ²	w/	Female, Micro Timer II
	191551	Pkg. 100	4 mm	0.5-1.5 mm ²	w/	Female, Junior Timer
	192175	Pkg. 100	4.3 mm	0.5-1 mm ²	w/	Female, Junior Power Timer
	192155	Pkg. 100	4.5 mm	1.5-2.5 mm ²	w/	Female, Junior Timer
	192443	Pkg. 100	4.8 mm	0.5-1 mm ²	w/o	Female, Flat For insulator
	191089	Pkg. 100	4.8 mm	0.5-1 mm ²	w/	Female, Flat Tin plated For multiplug
	192573	Pkg. 100	4.8 mm	0.5-1 mm ²	w/o	Female, Flat For insulator
	192998	Pkg. 100	5.3 mm	1.5-2.5 mm ²	w/	Female, Straight, Single, Crimp For multiplug
	192986	Pkg. 50	5.5 mm	0.5-1.25 mm ²	w/	Female, Flat, Straight, Single, Crimp
	192176	Pkg. 100	6 mm	1-2.5 mm ²	w/	Female, Junior, Power Timer
	192377	Pkg. 100	6.3 mm	0.5-1 mm ²	w/	Female, Flat For multiplug
	192574	Pkg. 100	6.3 mm	0.5-1 mm ²	w/o	Female, Flat For insulator
	193238	Pkg. 100	6.3 mm	0.5-1 mm ²	w/	Female, Flat For multiplug
	190868	Pkg. 100	6.3 mm	0.5-1 mm ²	w/	Female, Flat For multiplug
	191246	Pkg. 50	6.3 mm	0.5-1.5 mm ²	w/o	Female, Positive lock, Straight
	192381	Pkg. 50	6.3 mm	0.5-2 mm ²	w/o	Female, Flat, Tin plated Japanese type For insulator For multiplug

	HC-CARGO	Std pkg	Width	Cable size	Non return tag	Type
	192376	Pkg. 100	6.3 mm	1-2.5 mm ²	w/	Female, Flat For multiplug
	190252	Pkg. 100	6.3 mm	1-2.5 mm ²	w/	Female, Flat, Straight, Single For multiplug
	191008	Pkg. 100	6.3 mm	1-2.5 mm ²	w/o	Female, Flat For insulator
	191248	Pkg. 50	6.3 mm	1-2.5 mm ²	w/o	Female, Positive lock, Angled
	191029	Pkg. 100	6.3 mm	2.5-6 mm ²	w/	<i>Preformed.</i> Female, Flat For multiplug
	190725	Pkg. 100	6.3 mm	<2.5 mm ²	w/o	Female, Flat, Angled
	191064	Pkg. 100	6.3 mm	2.5-6 mm ²	w/o	Female, Flat For insulator
	192772	Pkg. 100	6.3 mm		w/o	PC board
	191247	Pkg. 50	7.3 mm	2.5-4 mm ²	w/o	Female, Positive lock, Straight
	191200	Pkg. 100	8 mm	1-2.5 mm ²	w/	Female, Flat For multiplug
	191260	Pkg. 20	8 mm	1-2.5 mm ²	w/o	Female, Positive lock Power connectors
	191261	Pkg. 20	8 mm	4-6 mm ²	w/o	Female, Positive lock Power connectors
	191262	Pkg. 20	8 mm	6-10 mm ²	w/o	Female, Positive lock Power connectors
	191938	Pkg. 100	9.1 mm	1-2.5 mm ²	w/	Female, Flat, Angled, Crimp
	191025	Pkg. 100	9.5 mm	2-4 mm ²	w/	Female, Flat Tin plated For multiplug
	191069	Pkg. 100	9.5 mm	2-4 mm ²	w/o	Female, Flat For insulator
	190726	Pkg. 50	9.5 mm	3-6 mm ²	w/o	Female, Flat, Angled, Crimp

ADAPTERS						
	HC-CARGO	Std pkg	Width	Cable size	Non return tag	Type
	191082	Pkg. 1		0.5-2.5 mm ²	w/o	Contains: 1x HC-CARGO 191078. 1x HC-CARGO 191079. 1x HC-CARGO 191080. 1x HC-CARGO 191081. Tin plated
	192383	Pkg. 100	7.6 mm	6.3x0.8 mm	w/o	Adaptor, Spade w/piggyback
	192575	Pkg. 50	9.6 mm	6.3x0.8 mm	w/o	Adaptor, Triple Tin plated
	190256	Pkg. 100	11.4 mm	6.3x0.8 mm	w/o	Adaptor, Spade w/piggyback
LEAF SPRING TERMINALS						
	HC-CARGO	Std pkg	Width	Cable size	Non return tag	Type
	192236	Pkg. 25	6.5 mm	0.5-1 mm ²	w/	Female, Blade fuse
	192237	Pkg. 25	6.5 mm	1.5-2.5 mm ²	w/	Female, Blade fuse
TIMER TERMINALS						
	HC-CARGO	Std pkg		Cable size	Non return tag	Type
	191556	Pkg. 100		1-2.5 mm ²	w/	Female, Standard timer
	192486	Pkg. 10		4-6 mm ²	w/	Female, Maxi Power Timer
FEMALE BULLET						
	HC-CARGO	Std pkg	Width	Cable size	Non return tag	Type
	191075	Pkg. 100	2 mm	0.5-1 mm ²	w/	Female, Round
	191916	Pkg. 100	3.2 mm	0.3-0.9 mm ²	w/	Mini. Female, Round
	191079	Pkg. 50	3.96 mm	0.5-2 mm ²	w/o	Female, Round Tin plated
	193250	Pkg. 100	4.1 mm	0.5-2.5 mm ²	w/	Female, Round
	191092	Pkg. 100	4.2 mm	0.5-2.1 mm ²	w/	Female, Round

	HC-CARGO	Std pkg	Width	Cable size	Non return tag	Type
	191544	Pkg. 100	4.2 mm	1-2.5 mm ²	w/	Female, Round
	191564	Pkg. 100	5.8 mm	0.5-2 mm ²	w/	Female, Round

MALE BULLET

	HC-CARGO	Std pkg	Width	Cable size	Non return tag	Type
	191915	Pkg. 100	3.6 mm	0.3-0.9 mm ²	w/	Male, Round
	191078	Pkg. 50	3.96 mm	0.5-2.5 mm ²	w/o	Male, Round
	191985	Pkg. 50	4 mm	0.7-1.5 mm ²	w/	Male, Round
	191074	Pkg. 100	4 mm	1-2.5 mm ²	w/	Male, Round
	191091	Pkg. 100	4.2 mm	0.5-2.1 mm ²	w/	Male, Round
	191543	Pkg. 100	4.2 mm	1-2.5 mm ²	w/	Male, Round
	191563	Pkg. 100	6.1 mm	0.5-2 mm ²	w/	Male, Round

MALE & FEMALE DEUTCH





	HC-CARGO	Std pkg	Cable size	Non return tag	Type
	192619	Pkg. 50	0.2-0.5 mm ²	w/o	DEUTSCH 0460-202-20141. Male, Round
	192620	Pkg. 50	0.2-0.5 mm ²	w/o	DEUTSCH 0462-201-20141. Female, Round
	192505	Pkg. 50	0.75-1.25 mm ²	w/o	DEUTSCH 0460-202-16141. Male, Round
	192506	Pkg. 50	0.75-1.25 mm ²	w/o	DEUTSCH 0462-201-16141. Female, Round
	192477	Pkg. 50	1.25-2 mm ²	w/o	DEUTSCH 0460-215-16141. Male, Round
	192478	Pkg. 50	1.25-2 mm ²	w/o	DEUTSCH 0462-209-16141. Female, Round

	HC-CARGO	Std pkg	Cable size	Non return tag	Type
	192621	Pkg. 50	2-3 mm ²	w/o	DEUTSCH 0460-204-11817. Male, Round
	192622	Pkg. 50	2-3 mm ²	w/o	DEUTSCH 0462-203-12141. Female, Round
	193233	Pkg. 1	5-8 mm ²	w/o	DEUTSCH 0460-204-08141. Male, Round
	193235	Pkg. 1	5-8 mm ²	w/o	DEUTSCH 0462-203-08141. Female, Round
	193234	Pkg. 1	13 mm ²	w/o	DEUTSCH 0460-204-0490. Male, Round
	193236	Pkg. 1	13 mm ²	w/o	DEUTSCH 0462-203-04141. Female, Round

WATERPROOF CONNECTOR TERMINALS

	HC-CARGO	Std pkg	Cable size	Non return tag	Type
	191168	Pkg. 10	1-2.5 mm ²	w/o	Female, ABS/EBS
	191196	Pkg. 10	1.5 mm ²	w/	Male, ABS/EBS
	191171	Pkg. 10	1.5-2.5 mm ²	w/	Male, ABS/EBS
	192180	Pkg. 10	1.5-2.5 mm ²	w/o	Female, ABS/EBS For multiplug
	191197	Pkg. 10	4 mm ²	w/	Male, ABS/EBS
	192181	Pkg. 10	4 mm ²	w/o	Female, ABS/EBS For multiplug
	191169	Pkg. 10	4-6 mm ²	w/o	Female, ABS/EBS
	191172	Pkg. 10	4-6 mm ²	w/	Male, ABS/EB



PINS

	HC-CARGO	Std pkg	Width	Cable size	Non return tag	Type
	191801	Pkg. 100	1.9 mm	1-2.5 mm ²	w/o	Pin
	191855	Pkg. 100	5.4 mm	2.6-4 mm ²	w/o	Pin
	192552	Pkg. 100	5.6 mm	2.5-4 mm ²	w/o	Pin
	193120	Pkg. 100	5.7 mm	4-6 mm ²	w/o	Pin, Round

SPRING TERMINALS

	HC-CARGO	Std pkg	Width	Cable size	Non return tag	Type
	191870	Pkg. 100	5.3 mm	1-1.5 mm ²	w/	Heavy duty. Fuse Holder: HC-CARGO 192759. Female, Blade fuse holder, Spring
	191412	Pkg. 100	5.3 mm	1-2.5 mm ²	w/	Fuse Holder: HC-CARGO 192759. Female, Blade fuse holder, Spring
	191871	Pkg. 100	5.3 mm	2.5-4 mm ²	w/	Heavy duty. Fuse Holder: HC-CARGO 192759. Female, Blade fuse holder, Spring
	191411	Pkg. 100	6.3 mm		w/	To be connected w/ 6.3 mm flat tongue terminal. Fuse Holder: HC-CARGO 192759. Female, Blade fuse holder, Spring
	191413	Pkg. 100	6.5 mm	2.5-6 mm ²	w/	Fuse Holder: HC-CARGO 192759. Female, Blade fuse holder, Spring
	191872	Pkg. 50	7.5 mm	4-6 mm ²	w/	Heavy duty. Fuse Holder: HC-CARGO 192759. Female, Blade fuse holder, Spring

FOR POWR-BLOKS

	HC-CARGO	Std pkg	Width	Cable size	Non return tag	Type
	191734	Pkg. 50	8.2 mm	1-2.5 mm ²	w/	Female, Powr-bloks
	192758	Pkg. 50	8.2 mm	3.5-5 mm ²	w/	Heavy duty. Female, Spring, Powr-bloks
	191733	Pkg. 50	8.4 mm	1-2.5 mm ²	w/	Female, Spring, Powr-bloks

CRIMP TERMINALS							
	HC-CARGO	Std pkg	Width	Cable size	Non return tag	Type	
	191739	Pkg. 50	2.8 mm	1-2.5 mm ²	w/o	Female, Powr-bloks	
	191740	Pkg. 50	2.8 mm	2.5-4 mm ²	w/o	Female, Powr-bloks	
	191737	Pkg. 50	4.7 mm	0.8-1.3 mm ²	w/o	Female, Powr-bloks	
	191738	Pkg. 50	4.7 mm	2.1-3.3 mm ²	w/o	Female, Powr-bloks	
	191764	Pkg. 50	6.3 mm	0.5-0.8 mm ²	w/	Female, Flat, Powr-bloks	
	191765	Pkg. 50	6.3 mm	1.3-2.1 mm ²	w/	Female, Flat, Powr-bloks	
	191766	Pkg. 50	6.3 mm	3.3-5.4 mm ²	w/	Female, Flat, Powr-bloks	
	191735	Pkg. 10	9.7 mm	2.1-3.3 mm ²	w/o	Female, Powr-bloks	
RING TERMINALS							
	HC-CARGO	Std pkg	Width	Cable size	ID	Non return tag	Type
	192003	Pkg. 100	5.3 mm	0.8-2 mm ²	5.3 mm	w/o	Ring
	191030	Pkg. 100	5.6 mm	0.8-2 mm ²	4.3 mm	w/o	Ring
	192004	Pkg. 100	6.4 mm	0.8-2.5 mm ²	6.4 mm	w/o	Ring
	192005	Pkg. 100	7.3 mm	2-4 mm ²	8.4 mm	w/o	Ring
FLAG RING TERMINALS							
	HC-CARGO	Std pkg	Width	Cable size	ID	Non return tag	Type
	191050	Pkg. 100	10 mm	0.3-1.7 mm ²	4.3 mm	w/o	Ring, Angled
	191051	Pkg. 100	10 mm	0.3-1.7 mm ²	5.3 mm	w/o	Ring, Angled
	191856	Pkg. 10	16 mm	10.5-16.8 mm ²	8.3 mm	w/o	Ring, Angled

CABLE JOINTS RING

DIN norm: 46234



HC-CARGO	Std pkg	Bolt size	Cable size	Material	Type
192975	Pkg. 100	M3	0.5-1.5 mm ²	Tin plated copper	Ring
191060	Pkg. 100	M4	0.25-1 mm ²	Tin plated copper	Ring
192134	Pkg. 50	M5	4-6 mm ²	Tin plated copper	Ring
192135	Pkg. 50	M5	10 mm ²	Tin plated copper	Ring
190846	Pkg. 50	M6	4-6 mm ²	Tin plated copper	Ring
190716	Pkg. 10	M6	10 mm ²	Tin plated copper	Ring
190717	Pkg. 10	M6	16 mm ²	Tin plated copper	Ring
191049	Pkg. 10	M8	10 mm ²	Tin plated copper	Ring
190718	Pkg. 10	M8	16 mm ²	Tin plated copper	Ring
190719	Pkg. 10	M8	25 mm ²	Tin plated copper	Ring
191416	Pkg. 10	M8	35 mm ²	Tin plated copper	Ring
190722	Pkg. 10	M8	50 mm ²	Tin plated copper	Ring
192557	Pkg. 10	M10	16 mm ²	Tin plated copper	Ring
190720	Pkg. 10	M10	25 mm ²	Tin plated copper	Ring
190721	Pkg. 10	M10	35 mm ²	Tin plated copper	Ring
190723	Pkg. 10	M10	50 mm ²	Tin plated copper	Ring
191884	Pkg. 10	M12	10 mm ²	Tin plated copper	Ring

CABLE LUGS RING



HC-CARGO	Std pkg	Bolt size	Cable size	ID	Material	Type
192905	Pkg. 10	M6	6 mm ²	6.5 mm	Tin plated copper	Straight, Solder
192908	Pkg. 10	M6	10 mm ²	6.5 mm	Tin plated copper	Straight, Single, Solder
192911	Pkg. 10	M6	16 mm ²	6.5 mm	Tin plated copper	Straight, Solder
192915	Pkg. 10	M6	25 mm ²	6.5 mm	Tin plated copper	Straight, Solder
192919	Pkg. 10	M6	35 mm ²	6.5 mm	Tin plated copper	Straight, Solder
192906	Pkg. 10	M8	6 mm ²	8.3 mm	Tin plated copper	Straight, Solder
192909	Pkg. 10	M8	10 mm ²	8.3 mm	Tin plated copper	Straight, Solder
192912	Pkg. 10	M8	16 mm ²	8.3 mm	Tin plated copper	Straight, Solder
192916	Pkg. 10	M8	25 mm ²	8.3 mm	Tin plated copper	Straight, Solder
192920	Pkg. 10	M8	35 mm ²	8.3 mm	Tin plated copper	Straight, Solder
192923	Pkg. 10	M8	50 mm ²	5.3 mm	Tin plated copper	Straight, Solder
192926	Pkg. 10	M8	70 mm ²	8.3 mm	Tin plated copper	Straight, Solder
193264	Pkg. 10	M8	95 mm ²	8.3 mm	Tin plated copper	Ring, Straight, Crimp
192907	Pkg. 10	M10	6 mm ²	10.3 mm	Tin plated copper	Straight, Solder
192910	Pkg. 10	M10	10 mm ²	10.3 mm	Tin plated copper	Straight, Solder
192913	Pkg. 10	M10	16 mm ²	10.3 mm	Tin plated copper	Straight, Solder
192917	Pkg. 10	M10	25 mm ²	10.3 mm	Tin plated copper	Straight, Solder
192921	Pkg. 10	M10	35 mm ²	10.3 mm	Tin plated copper	Straight, Solder
192924	Pkg. 10	M10	50 mm ²	10.3 mm	Tin plated copper	Straight, Solder
192927	Pkg. 10	M10	70 mm ²	10.3 mm	Tin plated copper	Straight, Solder
192932	Pkg. 10	M10	95 mm ²	10.3 mm	Tin plated copper	Ring, Straight, Crimp
192914	Pkg. 10	M12	16 mm ²	12.7 mm	Tin plated copper	Straight, Solder
192918	Pkg. 10	M12	25 mm ²	12.7 mm	Tin plated copper	Straight, Solder
192922	Pkg. 10	M12	35 mm ²	12.7 mm	Tin plated copper	Straight, Solder
192925	Pkg. 10	M12	50 mm ²	12.7 mm	Tin plated copper	Straight, Solder
192928	Pkg. 10	M12	70 mm ²	12.7 mm	Tin plated copper	Straight, Solder
192933	Pkg. 10	M12	95 mm ²	12.7 mm	Tin plated copper	Straight, Single, Solder

BUTT SPLICES



HC-CARGO	Std pkg	Cable size	ID	OD	Material
192007	Pkg. 100	0.5-1.5 mm ²	1.9 mm	3.3 mm	Tin plated copper
192008	Pkg. 100	1.5-2.5 mm ²	2.3 mm	4 mm	Tin plated copper
191885	Pkg. 10	4-6 mm ²	3.6 mm	5.5 mm	Tin plated copper
191886	Pkg. 10	8 mm ²	5.1 mm	7.1 mm	Tin plated copper
191887	Pkg. 10	14 mm ²	6.4 mm	9 mm	Tin plated copper
191888	Pkg. 10	22 mm ²	8.2 mm	11.4 mm	Tin plated copper
191889	Pkg. 10	38 mm ²	10.1 mm	13.3 mm	Tin plated copper
191890	Pkg. 10	60 mm ²	12 mm	15.4 mm	Tin plated copper
191891	Pkg. 10	70 mm ²	14 mm	17.4 mm	Tin plated copper
193168	Pkg. 10	80 mm ²	14.5 mm	19.5 mm	Tin plated copper

CORD END TERMINALS

	HC-CARGO	Std pkg	Cable size	ID	OD	Material
DIN norm: 46228/1						
	191962	Pkg. 100	0.5 mm ²	1 mm	2.1 mm	Tin plated copper
	191963	Pkg. 100	0.75 mm ²	1.2 mm	2.3 mm	Tin plated copper
	191964	Pkg. 100	1 mm ²	1.4 mm	2.5 mm	Tin plated copper
	191965	Pkg. 100	1.5 mm ²	1.7 mm	2.8 mm	Tin plated copper
	191966	Pkg. 100	2.5 mm ²	2.2 mm	3.4 mm	Tin plated copper
	191967	Pkg. 100	4 mm ²	2.8 mm	4 mm	Tin plated copper
	191968	Pkg. 100	6 mm ²	3.5 mm	4.7 mm	Tin plated copper
	191969	Pkg. 100	10 mm ²	4.5 mm	5.8 mm	Tin plated copper
192047	Pkg. 100	16 mm ²	5.8 mm	7.5 mm	Tin plated copper	

IGNITION COIL TERMINALS

	HC-CARGO	Std pkg	OD	Type
	192225	Pkg. 50	7 mm	Universal.
	192222	Pkg. 10	7 mm	w/ clip.
	192224	Pkg. 100	7 mm	Angled 90°
	190052	Pkg. 100	7 mm	

FOR POWER CONNECTORS

	HC-CARGO	Std pkg	Width	Cable size	Non return tag	Type
	191263	Pkg. 100	8 mm	2.5x4 mm ²	w/	Male, Flat, Power connectors
	191983	Pkg. 20	8 mm	4x10 mm ²	w/	Male, Flat, Power connectors
	191264	Pkg. 20	8 mm	10x16 mm ²	w/	Male, Flat, Power connectors

SCREW TYPE

	HC-CARGO	Std pkg	Width	Cable size	Angled	Non return tag	Type
	191016	Pkg. 100	6.3 mm	4.2 mm	45°	w/o	Male, Flat, Screw
	192576	Pkg. 100	6.3 mm	4.2 mm	45°	w/o	Male, Flat, Dual
	190283	Pkg. 100	6.3 mm	5.2 mm	45°	w/o	Male, Flat, Screw
	191047	Pkg. 100	6.3 mm	5.2 mm	90°	w/o	Male, Flat, Screw
	191791	Pkg. 100	6.3 mm	6.3 mm	45°	w/o	Male, Flat, Screw
	192242	Pkg. 100	6.3 mm	8.4 mm	45°	w/o	Male, Flat, Screw
	191044	Pkg. 100	6.3x8 mm	5.2 mm	180°	w/o	Male, Flat, Screw, Power connectors
	191048	Pkg. 100	9.5 mm	5.3 mm	180°	w/o	Male, Flat, Screw

TOOLS

CRIMPING

FOR INSULATED TERMINALS

210121 Crimping Tools Std pkg 1 Servicing: Insulated crimp terminals - Visit our web catalogue for further information w/ cable cutter.









Dim.: 0.25-6 mm²











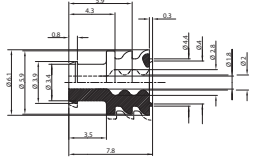

210638 Crimping Tools Std pkg 1 Servicing: Insulated crimp terminals - Visit our web catalogue for further information

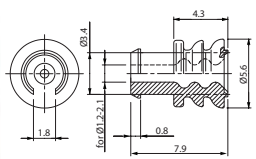

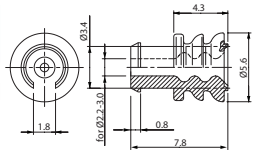
Dim.: 0.5-6 mm²

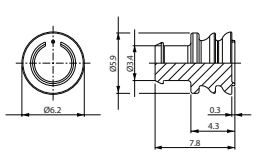
FOR NON-INSULATED TERMINALS

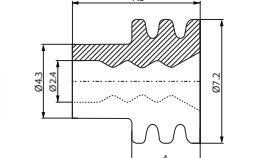
FOR NON-INSULATED TERMINALS		EL. SPECIFICATIONS	DIMENSIONS	ADDITIONAL SPECIFICATIONS
210639	Crimping Tools	Std pkg 1	Servicing: Uninsulated Crimp Terminals - Visit our web catalogue for further information	
			Dim.: 0.5-6 mm ²	
210689	Crimping Tools	Std pkg 1	Servicing: Non insulated crimp terminals, suitable for AMP terminals - Visit our web catalogue for further information	
			Dim.: 0.25-6 mm ²	
210696	Crimping Tools	Std pkg 1	Servicing: Uninsulated Crimp Terminals - Visit our web catalogue for further information	
			Dim.: 1.5-10 mm ²	Terminal type: ABS
210760	Crimping Tools	Std pkg 1	Servicing: Suitable for shrink copper tube terminals - Visit our web catalogue for further information	
			Dim.: 10-95 mm ²	
210937	Crimping Tools	Std pkg 1	w/ cable cutter.	
			Dim.: 1.5-6 mm ²	
210938	Crimping Tools	Std pkg 1	Servicing: For cord end terminals - Visit our web catalogue for further information	
			Dim.: 0.5-6 mm ²	
210939	Crimping Tools	Std pkg 1	Servicing: For cord end terminals - Visit our web catalogue for further information	
			Dim.: 6-16 mm ²	

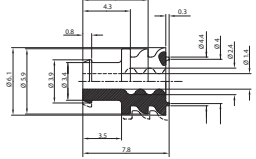
EL. SPECIFICATIONS		DIMENSIONS	ADDITIONAL SPECIFICATIONS
210973 Crimping Tools Std pkg 1		Servicing: Universal crimp tool for solid terminals, DEUTSCH etc - Visit our web catalogue for further information	
		Dim.: 0.5-2 mm ²	
SINGLE WIRE SEAL NON INSULATED			
192091 Superseal Wire Seal Std pkg 100		Servicing: HC-CARGO 192077, 192078, 192079, 192080, 192081, 192082, 192083, 192084, 192085, 192086, 192087, 192088, 193266, 193267	
<i>For Super Seal housing.</i>			
 		Cable dia.: 1.5-2.5 mm ID: 1.8/2 mm OD: 6.1 mm Length: 7.8 mm	
192177 Wire Seal Std pkg 100		Servicing: HC-CARGO 192146, 192147, 192148, 192149, 192166, 192167, 1932171, 192172, 192173, 192502, 192884, 192902, 193119	
<i>For Junior-Power-Timer.</i>			
 		Cable dia.: 1.2-2.1 mm ID: 1.8 mm OD: 5.6 mm Length: 7.9 mm Height: 5.2 mm	
192178 Wire Seal Std pkg 100		Servicing: HC-CARGO 192146, 192147, 192148, 192149, 192166, 192167, 1932171, 192172, 192173, 192502, 192884, 192902, 193119	
<i>For Junior-Power-Timer.</i>			
 		Cable dia.: 1.5-2 mm ID: 1.8 mm OD: 5.6 mm Length: 7.8 mm	
192179 JPT Blanking Plug Std pkg 100		Servicing: HC-CARGO 192146, 192147, 192148, 192149, 192166, 192167, 1932171, 192172, 192173, 192502, 192884, 192902, 193119	
<i>For Junior-Power-Timer housing.</i>			
 		Cable dia.: 1.5-2 mm ID: 3.4 mm OD: 6.1 mm Length: 7.8 mm	
192375 Single Wire Seal Std pkg 50		Servicing: HC-CARGO 192374, 192373	
<i>For metripack terminals.</i>			
 		Cable dia.: 1-2.5 mm ID: 2.4 mm OD: 7.2 mm Length: 7.5 mm	
192587 Single Wire Seal Std pkg 100		Servicing: HC-CARGO 192077, 192078, 192079, 192080, 192081, 192082, 192083, 192084, 192085, 192086, 192087, 192088	
<i>For Super Seal housing.</i>			
 		Cable dia.: 0.75-1.5 mm ID: 1.4-2.4 mm OD: 6.1 mm Length: 7.8 mm	

192647 Rubber Silicone Seal Std pkg 100 Servicing: HC-CARGO 192631, 192632, 192633, 192634, 192635, 192636, 192637

For fuse holder. Hole size: 8.2 mm.

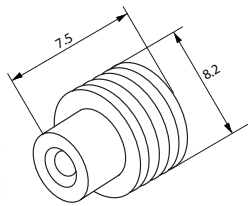

Cable dia.: 2-3 mm
ID: 1.9-3 mm
OD: 8.2 mm
Length: 7.5 mm

Colour: White
Material: Silicone rubber

192859 Blanking Plug Std pkg 100

For Super Seal housing.

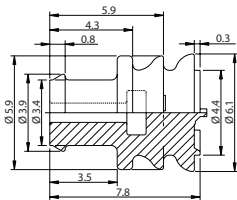

OD: 6.1 mm
Length: 7.8 mm

Colour: Red
Material: Silicone rubber

TERMINAL COVER

NON INSULATED

180105 Protection Cap Std pkg 500 Servicing: HC-CARGO 180112, 180153, 180219, 180240, 180296, 180351, 180568, 180569



Voltage: 24

No./poles: 7

180106 Protection Cap Std pkg 10 Servicing: HC-CARGO 180112, 180153, 180219, 180240, 180296, 180351, 180568, 180569



Voltage: 24

No./poles: 7

192808 Terminal Cover Std pkg 10



Terminal 1: 12 mm
Terminal 2: 25.4 mm
Cable dia.: 7.62 mm
ID: 12.7 mm
OD: 14 mm
Height: 17.8 mm

Colour: Black
Material: PVC

192809 Terminal Cover Std pkg 10



Terminal 1: 14 mm
Terminal 2: 25.4 mm
Cable dia.: 7.62 mm
ID: 12.7 mm
OD: 14 mm
Height: 19 mm

Colour: Black
Material: PVC

192810 Terminal Cover Std pkg 10



Terminal 1: 18 mm
Terminal 2: 25.4 mm
Cable dia.: 7.62 mm
ID: 12.7 mm
OD: 18 mm
Height: 22.1 mm

Colour: Black
Material: PVC

EL. SPECIFICATIONS		DIMENSIONS	ADDITIONAL SPECIFICATIONS
192811	Terminal Cover Std pkg 10		Terminal 1: 20 mm Terminal 2: 33.5 mm Cable dia.: 12.7 mm ID: 17.8 mm OD: 20 mm Height: 24.1 mm Colour: Black Material: PVC
192812	Terminal Cover Std pkg 10		Terminal 1: 24 mm Terminal 2: 41.2 mm Cable dia.: 12.7 mm ID: 17.8 mm OD: 24 mm Height: 28.7 mm Colour: Black Material: PVC
192813	Terminal Cover Std pkg 10		Terminal 1: 32 mm Terminal 2: 44.5 mm Cable dia.: 17.8 mm ID: 22.9 mm OD: 32 mm Height: 38.1 mm Colour: Black Material: PVC
192828	Terminal Cover Std pkg 10		Terminal 1: 12 mm Terminal 2: 25.4 mm Cable dia.: 7.62 mm ID: 12.7 mm OD: 14 mm Height: 17.8 mm Colour: Red Material: PVC
192829	Terminal Cover Std pkg 10		Terminal 1: 14 mm Terminal 2: 25.4 mm Cable dia.: 7.62 mm ID: 12.7 mm OD: 14 mm Height: 19.1 mm Colour: Red Material: PVC
192830	Terminal Cover Std pkg 10		Terminal 1: 18 mm Terminal 2: 25.4 mm Cable dia.: 7.62 mm ID: 12.7 mm OD: 18 mm Height: 22.1 mm Colour: Red Material: PVC
192831	Terminal Cover Std pkg 10		Terminal 1: 20 mm Terminal 2: 33.5 mm Cable dia.: 12.7 mm ID: 17.8 mm OD: 20 mm Height: 24.1 mm Colour: Red Material: PVC
192832	Terminal Cover Std pkg 10		Terminal 1: 24 mm Terminal 2: 41.2 mm Cable dia.: 12.7 mm ID: 17.8 mm OD: 24 mm Height: 28.7 mm Colour: Red Material: PVC

192833 Terminal Cover Std pkg 10

 Terminal 1: 32 mm
 Terminal 2: 44.5 mm
 Cable dia.: 17.8 mm
 ID: 22.9 mm
 OD: 32 mm
 Height: 38.1 mm

 Colour: Red
 Material: PVC

MULTIPLE CONNECTORS
INSULATORS
FEMALE HOLDERS
191007 Insulator Std pkg 100

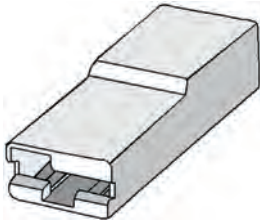
Terminal: HC-CARGO 191008, 191064.

 Colour: White
 Male/female: Female

191081 Insulator Std pkg 100 Servicing: HC-CARGO 191082, 8600889

Terminal: HC-CARGO 191079.

 Colour: Transparent
 Male/female: Female

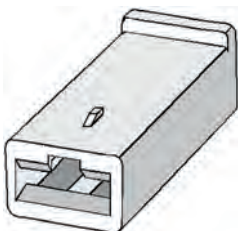
191127 Insulator Std pkg 100

Terminal: HC-CARGO 190252, 191029.

 Colour: White
 Male/female: Female

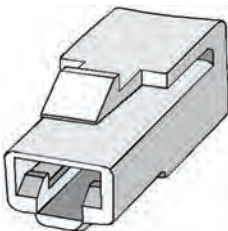



191227 Insulator Std pkg 100

Terminal: HC-CARGO 192381.

 Type: Japanese
 Colour: White
 Male/female: Female

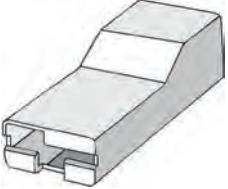
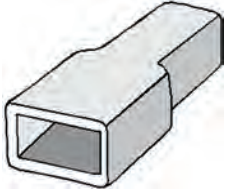
191751 Insulator Std pkg 100

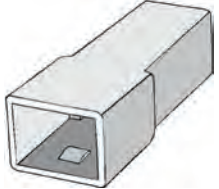
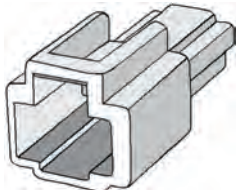
Terminal: HC-CARGO 191246, 191247.

 Colour: Black
 Male/female: Female

191937 Insulator Std pkg 100 <i>Terminal: HC-CARGO 191069.</i>			
			Colour: White Male/female: Female
192442 Insulator Std pkg 100 <i>Terminal: HC-CARGO 192443.</i>			
			Colour: White Male/female: Female
MALE HOLDERS			
191080 Insulator Std pkg 100 Servicing: HC-CARGO 191082, 8600889 <i>Terminal: HC-CARGO 191078.</i>			
			Colour: Transparent Male/female: Male
191126 Insulator Std pkg 100 <i>Terminal: HC-CARGO 190270, 191028.</i>			
			Colour: White Male/female: Male
191226 Insulator Std pkg 100 <i>Terminal: HC-CARGO 192380.</i>			
		Length: 28.5 mm	Type: Japanese Colour: White Male/female: Male
191650 Insulator Std pkg 100 <i>Terminal: HC-CARGO 191415.</i>			
			Colour: Black Male/female: Male
192002 Insulator Std pkg 100			
			Type: Flag Colour: White Male/female: Male

HOLDERS

2 POLE

190260 Connector Std pkg 10

Terminal: HC-CARGO 190270, 191028.

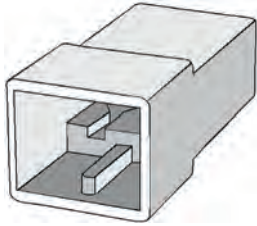

Colour: White
No./poles: 2
Plug: Male

190261 Connector Std pkg 10 Servicing: HC-CARGO 171955

Terminal: HC-CARGO 190252, 191029. Rubber Boot: HC-CARGO 193010.

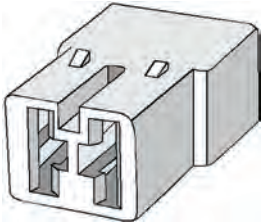

Colour: White
No./poles: 2
Plug: Female

190272 Connector Std pkg 10

Terminal: HC-CARGO 190252, 191029.

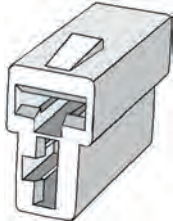

Type/terminal: T-type
Colour: White
No./poles: 2
Plug: Female

190843 Connector Std pkg 10

Terminal: HC-CARGO 190270, 191028.

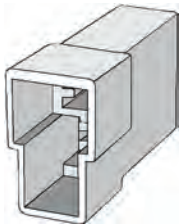

Type/terminal: T-type
Colour: White
No./poles: 2
Plug: Male

191158 Connector Std pkg 10

Terminal: HC-CARGO 192380.

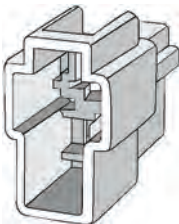

Type/terminal: Japanese type
Colour: White
No./poles: 2
Plug: Male

191159 Connector Std pkg 10

Terminal: HC-CARGO 192381.



Type/terminal: Japanese type
Colour: Black
No./poles: 2
Plug: Female

191808 Connector Std pkg 10 Servicing: Car Heaters - Visit our web catalogue for further information

Terminal: HC-CARGO 191563.

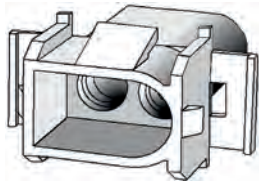

Colour: White
No./poles: 2
Plug: Male

191809 Connector Std pkg 10 Servicing: Car Heaters - Visit our web catalogue for further information

Terminal: HC-CARGO 191564.

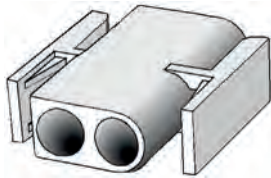

Colour: White
No./poles: 2
Plug: Female

3 POLE

190262 Connector Std pkg 10

Terminal: HC-CARGO 190270, 191028.

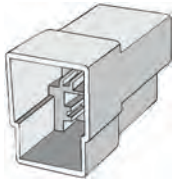

Colour: White
No./poles: 3
Plug: Male

190263 Connector Std pkg 10

Terminal: HC-CARGO 190252, 191029.

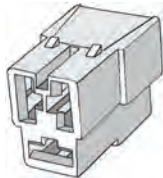

Colour: White
No./poles: 3
Plug: Female

191224 Connector Std pkg 10

Terminal: HC-CARGO 192380.

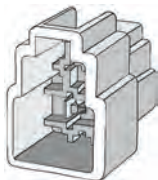

Type/terminal: Japanese type
Colour: White
No./poles: 3
Plug: Male

191225 Connector Std pkg 10

Terminal: HC-CARGO 192376.

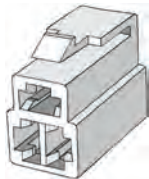

Type/terminal: Japanese type
Colour: White
No./poles: 3
Plug: Female

4 POLE

190264 Connector Std pkg 10

Terminal: HC-CARGO 190270, 191028.

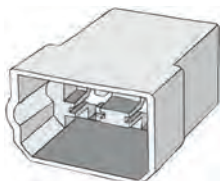

Colour: White
Material: Nylon 6.6 UL94-V2
No./poles: 4
Plug: Male

190265 Connector Std pkg 10

Terminal: HC-CARGO 190252, 191029.

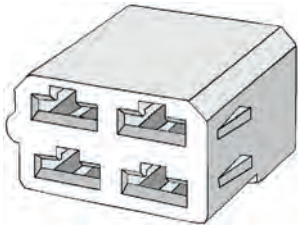
 Colour: White
 Material: Nylon 6.6 UL94-V2
 No./poles: 4
 Plug: Female

191070 Connector Std pkg 10

Terminal: HC-CARGO 191074.

 Colour: White
 No./poles: 4
 Plug: Male

191071 Connector Std pkg 10

Terminal: HC-CARGO 191075.

 Colour: White
 No./poles: 4
 Plug: Female

6 POLE

190266 Connector Std pkg 10

Terminal: HC-CARGO 190270, 191028.

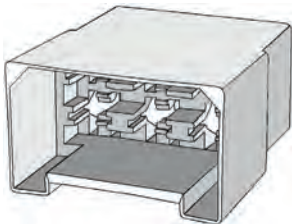
 Colour: White
 No./poles: 6
 Plug: Male

190267 Connector Std pkg 10

Terminal: HC-CARGO 190252, 191029.

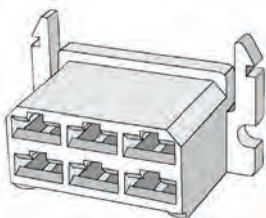
 Colour: White
 No./poles: 6
 Plug: Female

8 POLE

190268 Connector Std pkg 10

Terminal: HC-CARGO 190270, 191028.

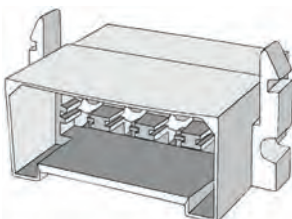
 Colour: White
 No./poles: 8
 Plug: Male

190269 Connector Std pkg 10

Terminal: HC-CARGO 190252, 191029.

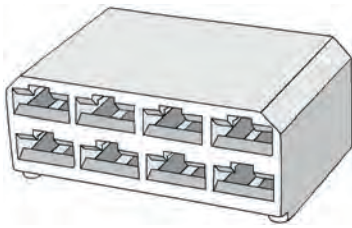

Colour: White
No./poles: 8
Plug: Female

9 POLE

191561 Connector Std pkg 10

Terminal: HC-CARGO 191563.

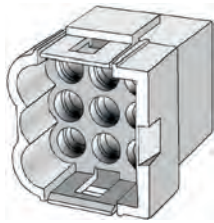

Colour: White
No./poles: 9
Plug: Male

191562 Connector Std pkg 10

Terminal: HC-CARGO 191564.

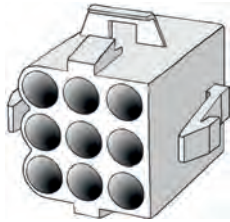

Colour: White
No./poles: 9
Plug: Female

12 POLE

192488 Connector Std pkg 10

Terminal: HC-CARGO 191092.

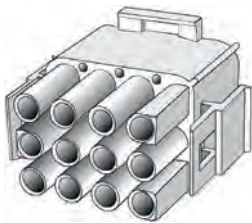

Colour: White
No./poles: 12
Plug: Male

192501 Connector Std pkg 10

Terminal: HC-CARGO 191091.

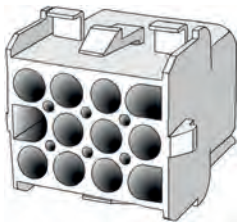

Colour: White
No./poles: 12
Plug: Female

ACCESSORIES

193010 Rubber Boot Std pkg 10 Servicing: HC-CARGO 190261, 171955



Material: EPDM rubber

DEUTSCH-CONNECTOR DT

2 POLE

192457 DT Connector Std pkg 5 Servicing: HC-CARGO 193349

DT06-2S. Terminal: HC-CARGO 192478. Secondary lock: HC-CARGO 192467. Rubber Boot: HC-CARGO 193092.



Type/terminal: DT
Colour: Grey
No./poles: 2
Plug: Female

192458 DT Connector Std pkg 5 Servicing: HC-CARGO 193350

DT04-2P. Terminal: HC-CARGO 192477. Secondary lock: HC-CARGO 192468. Rubber Boot: HC-CARGO 193091.



Type/terminal: DT
Colour: Grey
No./poles: 2
Plug: Male

193349 DT Connector kit Std pkg 1

Consists: 1x Connector: HC-CARGO 192457. 1x Secondary Lock: HC-CARGO 192467. 2x Terminal: HC-CARGO 192478.



Type/terminal: DT
Colour: Grey
No./poles: 2
Plug: Female

193350 DT Connector kit Std pkg 1

Consists: 1x Connector: HC-CARGO 192458. 1x Secondary Lock: HC-CARGO 192468. 2x Terminal: HC-CARGO 192477.



Type/terminal: DT
Colour: Grey
No./poles: 2
Plug: Male

ACCESSORIES

192467 Secondary Lock Std pkg 10 Servicing: HC-CARGO 192457, 193349

W 2S.







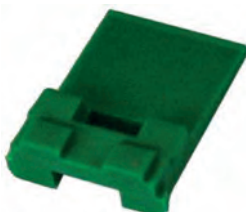

Type/terminal: DT
No./poles: 2
Plug: Female

192468 Secondary Lock Std pkg 10 Servicing: HC-CARGO 192458, 193350

W 2P.



Type/terminal: DT
No./poles: 2
Plug: Male

		EL. SPECIFICATIONS	DIMENSIONS	ADDITIONAL SPECIFICATIONS
193091	Rubber Boot	Std pkg 5	Servicing: HC-CARGO 192458	
				Type/terminal: DT Colour: Grey No./poles: 2
193092	Rubber Boot	Std pkg 5	Servicing: HC-CARGO 192457	
				Type/terminal: DT Colour: Grey No./poles: 2
3 POLE				
192459	DT Connector	Std pkg 5	Servicing: HC-CARGO 193351	
<i>DT06-3S. Terminal: HC-CARGO 192478. Secondary lock: HC-CARGO 192469. Rubber Boot: HC-CARGO 193094.</i>				
				Type/terminal: DT Colour: Grey No./poles: 3 Plug: Female
192460	DT Connector	Std pkg 5	Servicing: HC-CARGO 193352	
<i>DT04-3P. Terminal: HC-CARGO 192477. Secondary lock: HC-CARGO 192470. Rubber Boot: HC-CARGO 193093.</i>				
				Type/terminal: DT Colour: Grey No./poles: 3 Plug: Male
193351	DT Connector kit	Std pkg 1		
<i>Consists: 1x Connector: HC-CARGO 192459. 1x Secondary Lock: HC-CARGO 192469. 3x Terminal: HC-CARGO 192478.</i>				
				Type/terminal: DT Colour: Grey No./poles: 3 Plug: Female
193352	DT Connector kit	Std pkg 1		
<i>Consists: 1x Connector: HC-CARGO 192460. 1x Secondary Lock: HC-CARGO 192470. 3x Terminal: HC-CARGO 192477.</i>				
				Type/terminal: DT Colour: Grey No./poles: 3 Plug: Male
ACCESSORIES				
192469	Secondary Lock	Std pkg 10	Servicing: HC-CARGO 192459, 193351	
<i>W 3S.</i>				
				Type/terminal: DT No./poles: 3 Plug: Female

192470 Secondary Lock Std pkg 10 Servicing: HC-CARGO 192460, 193352 <i>W 3P.</i>				Type/terminal: DT No./poles: 3 Plug: Male
193093 Rubber Boot Std pkg 5 Servicing: HC-CARGO 192460				Type/terminal: DT Colour: Grey No./poles: 3
193094 Rubber Boot Std pkg 5 Servicing: HC-CARGO 192459				Type/terminal: DT Colour: Grey No./poles: 3
4 POLE				
192461 DT Connector Std pkg 5 Servicing: HC-CARGO 193353 <i>DT06-4S. Terminal: HC-CARGO 192478. Secondary lock: HC-CARGO 192471. Rubber Boot: HC-CARGO 193096.</i>				Type/terminal: DT Colour: Grey No./poles: 4 Plug: Female
192462 DT Connector Std pkg 5 Servicing: HC-CARGO 193354 <i>DT04-4P. Terminal: HC-CARGO 192477. Secondary lock: HC-CARGO 192472. Rubber Boot: HC-CARGO 193095.</i>				Type/terminal: DT Colour: Grey No./poles: 4 Plug: Male
193353 DT Connector kit Std pkg 1 <i>Consists: 1x Connector: HC-CARGO 192461. 1x Secondary Lock: HC-CARGO 192471. 4x Terminal: HC-CARGO 192478.</i>				Type/terminal: DT Colour: Grey No./poles: 4 Plug: Female
193354 DT Connector kit Std pkg 1 <i>Consists: 1x Connector: HC-CARGO 192462. 1x Secondary Lock: HC-CARGO 192472. 4x Terminal: HC-CARGO 192477.</i>				Type/terminal: DT Colour: Grey No./poles: 4 Plug: Male

ACCESSORIES			
192471	Secondary Lock	Std pkg 10	Servicing: HC-CARGO 192461, 193353
W 4S.			
			Type/terminal: DT No./poles: 4 Plug: Female
192472	Secondary Lock	Std pkg 10	Servicing: HC-CARGO 192462, 193354
W 4P.			
			Type/terminal: DT No./poles: 4 Plug: Male
193095	Rubber Boot	Std pkg 5	Servicing: HC-CARGO 192462
			Type/terminal: DT Colour: Grey No./poles: 4
193096	Rubber Boot	Std pkg 5	Servicing: HC-CARGO 192461
			Type/terminal: DT Colour: Grey No./poles: 4
6 POLE			
192463	DT Connector	Std pkg 5	Servicing: HC-CARGO 193355
DT06-6S. Terminal: HC-CARGO 192478. Secondary lock: HC-CARGO 192473. Rubber Boot: HC-CARGO 193098.			
			Type/terminal: DT Colour: Grey No./poles: 6 Plug: Female
192464	DT Connector	Std pkg 5	Servicing: HC-CARGO 193356
DT04-6P. Terminal: HC-CARGO 192477. Secondary lock: HC-CARGO 192474. Rubber Boot: HC-CARGO 193097.			
			Type/terminal: DT Colour: Grey No./poles: 6 Plug: Male
193355	DT Connector kit	Std pkg 1	
Consists: 1x Connector: HC-CARGO 192463. 1x Secondary Lock: HC-CARGO 192473. 6x Terminal: HC-CARGO 192478.			
			Type/terminal: DT Colour: Grey No./poles: 6 Plug: Female

193356 DT Connector kit Std pkg 1

Consists: 1x Connector: HC-CARGO 192464. 1x Secondary Lock: HC-CARGO 192474. 6x Terminal: HC-CARGO 192477.



Type/terminal: DT
 Colour: Grey
 No./poles: 6
 Plug: Male

ACCESSORIES

192473 Secondary Lock Std pkg 10 Servicing: HC-CARGO 192463, 193355

W 6S.



Type/terminal: DT
 No./poles: 6
 Plug: Female

192474 Secondary Lock Std pkg 10 Servicing: HC-CARGO 192464, 193356

W 6P.



Type/terminal: DT
 No./poles: 6
 Plug: Male

193097 Rubber Boot Std pkg 5 Servicing: HC-CARGO 192464



Type/terminal: DT
 Colour: Grey
 No./poles: 6

193098 Rubber Boot Std pkg 5 Servicing: HC-CARGO 192463



Type/terminal: DT
 Colour: Grey
 No./poles: 6

8 POLE

192465 DT Connector Std pkg 5

DT06-8S. Terminal: HC-CARGO 192478. Secondary lock: HC-CARGO 192475. Rubber Boot: HC-CARGO 193100.









Type/terminal: DT
 Colour: Grey
 No./poles: 8
 Plug: Female

192466 DT Connector Std pkg 5

DT04-8P. Terminal: HC-CARGO 192477. Secondary lock: HC-CARGO 192476. Rubber Boot: HC-CARGO 193099.



Type/terminal: DT
 Colour: Grey
 No./poles: 8
 Plug: Male

ACCESSORIES			
192475	Secondary Lock	Std pkg 10	Servicing: HC-CARGO 192465
W 8S.			
			Type/terminal: DT No./poles: 8 Plug: Female
192476	Secondary Lock	Std pkg 10	Servicing: HC-CARGO 192466
W 8P.			
			Type/terminal: DT No./poles: 8 Plug: Male
193099	Rubber Boot	Std pkg 5	Servicing: HC-CARGO 192466
			Type/terminal: DT Colour: Grey No./poles: 8
193100	Rubber Boot	Std pkg 5	Servicing: HC-CARGO 192465
			Type/terminal: DT Colour: Grey No./poles: 8
12 POLE			
192450	DT Connector	Std pkg 5	
DT06-12S. Terminal: HC-CARGO 192478. Secondary lock: HC-CARGO 192452. Rubber Boot: HC-CARGO 193102.			
			Type/terminal: DT Colour: Grey No./poles: 12 Plug: Female
192451	DT Connector	Std pkg 5	
DT04-12P. Terminal: HC-CARGO 192477. Secondary lock: HC-CARGO 192453. Rubber Boot: HC-CARGO 193101.			
			Type/terminal: DT Colour: Grey No./poles: 12 Plug: Male
ACCESSORIES			
192452	Secondary Lock	Std pkg 10	Servicing: HC-CARGO 192450
W 12S.			
			Type/terminal: DT No./poles: 12 Plug: Female

192453 Secondary Lock Std pkg 10 Servicing: HC-CARGO 192451

W 12P.

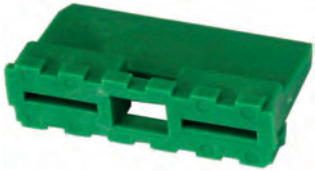

Type/terminal: DT
No./poles: 12
Plug: Male

193101 Rubber Boot Std pkg 5 Servicing: HC-CARGO 192451



Type/terminal: DT
Colour: Grey
No./poles: 12

193102 Rubber Boot Std pkg 5 Servicing: HC-CARGO 192450



Type/terminal: DT
Colour: Grey
No./poles: 12

DEUTSCH-CONNECTOR DTM

2 POLE

192595 DTM Connector Std pkg 5 Servicing: HC-CARGO 193357

DTM06-2S. Terminal: HC-CARGO 192620. Secondary lock: HC-CARGO 192607. Rubber Boot: HC-CARGO 193104.



Type/terminal: DTM
Colour: Grey
No./poles: 2
Plug: Female

192596 DTM Connector Std pkg 5 Servicing: HC-CARGO 193358

DTM04-2P. Terminal: HC-CARGO 192619. Secondary lock: HC-CARGO 192608. Rubber Boot: HC-CARGO 193103.



Type/terminal: DTM
Colour: Grey
No./poles: 2
Plug: Male

193357 DTM Connector kit Std pkg 1

Consists: 1x Connector: HC-CARGO 192595. 1x Secondary Lock: HC-CARGO 192607. 2x Terminal: HC-CARGO 192620.









Type/terminal: DTM
Colour: Grey
No./poles: 2
Plug: Female

193358 DTM Connector kit Std pkg 1

Consists: 1x Connector: HC-CARGO 192596. 1x Secondary Lock: HC-CARGO 192608. 2x Terminal: HC-CARGO 192619.

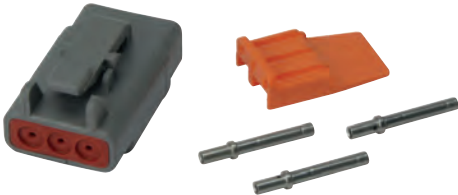

Type/terminal: DTM
Colour: Grey
No./poles: 2
Plug: Male

ACCESSORIES			
192607	Secondary Lock	Std pkg 10	Servicing: HC-CARGO 192595, 193357
WM 2S.			
			Type/terminal: DTM No./poles: 2 Plug: Female
192608	Secondary Lock	Std pkg 10	Servicing: HC-CARGO 192596, 193358
WM 2P.			
			Type/terminal: DTM No./poles: 2 Plug: Male
193103	Rubber Boot	Std pkg 5	Servicing: HC-CARGO 192596
			Type/terminal: DTM Colour: Grey No./poles: 2
193104	Rubber Boot	Std pkg 5	Servicing: HC-CARGO 192595
			Type/terminal: DTM Colour: Grey No./poles: 2
3 POLE			
192597	DTM Connector	Std pkg 5	Servicing: HC-CARGO 193359
DTM06-3S. Terminal: HC-CARGO 192620. Secondary lock: HC-CARGO 192609. Rubber Boot: HC-CARGO 193106.			
			Type/terminal: DTM Colour: Grey No./poles: 3 Plug: Female
192598	DTM Connector	Std pkg 5	Servicing: HC-CARGO 193360
DTM04-3P. Terminal: HC-CARGO 192619. Secondary lock: HC-CARGO 192610. Rubber Boot: HC-CARGO 193105.			
			Type/terminal: DTM Colour: Grey No./poles: 3 Plug: Male
193359	DTM Connector kit	Std pkg 1	
Consists: 1x Connector: HC-CARGO 192597. 1x Secondary Lock: HC-CARGO 192609. 2x Terminal: HC-CARGO 192620.			
			Type/terminal: DTM Colour: Grey No./poles: 3 Plug: Female

193360 DTM Connector kit Std pkg 1

Consists: 1x Connector: HC-CARGO 192598. 1x Secondary Lock: HC-CARGO 192610. 2x Terminal: HC-CARGO 192619.

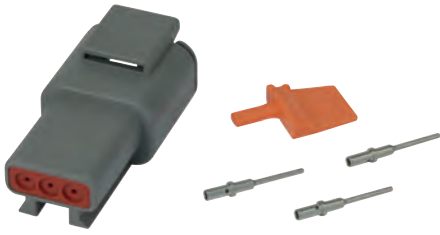

Type/terminal: DTM
 Colour: Grey
 No./poles: 3
 Plug: Male

ACCESSORIES

192609 Secondary Lock Std pkg 10 Servicing: HC-CARGO 192597, 193359

WM 3S.



Type/terminal: DTM
 No./poles: 3
 Plug: Female

192610 Secondary Lock Std pkg 10 Servicing: HC-CARGO 192598, 193360

WM 3P.



Type/terminal: DTM
 No./poles: 3
 Plug: Male

193105 Rubber Boot Std pkg 5 Servicing: HC-CARGO 192598



Type/terminal: DTM
 Colour: Grey
 No./poles: 3

193106 Rubber Boot Std pkg 5 Servicing: HC-CARGO 192597



Type/terminal: DTM
 Colour: Grey
 No./poles: 3







4 POLE

192599 DTM Connector Std pkg 5 Servicing: HC-CARGO 193361

DTM06-4S. Terminal: HC-CARGO 192620. Secondary lock: HC-CARGO 192611. Rubber Boot: HC-CARGO 193108.



Type/terminal: DTM
 Colour: Grey
 No./poles: 4
 Plug: Female

192600 DTM Connector Std pkg 5 Servicing: HC-CARGO 193362 <i>DTM04-4P. Terminal: HC-CARGO 192619. Secondary lock: HC-CARGO 192612. Rubber Boot: HC-CARGO 193107.</i>					Type/terminal: DTM Colour: Grey No./poles: 4 Plug: Male
					
193361 DTM Connector kit Std pkg 1 <i>Consists: 1x Connector: HC-CARGO 192599. 1x Secondary Lock: HC-CARGO 192611. 2x Terminal: HC-CARGO 192620.</i>					Type/terminal: DTM Colour: Grey No./poles: 4 Plug: Female
					
193362 DTM Connector kit Std pkg 1 <i>Consists: 1x Connector: HC-CARGO 192600. 1x Secondary Lock: HC-CARGO 192612. 2x Terminal: HC-CARGO 192619.</i>					Type/terminal: DTM Colour: Grey No./poles: 4 Plug: Male
					
ACCESSORIES					
192611 Secondary Lock Std pkg 10 Servicing: HC-CARGO 192599, 193361 <i>WM 4S.</i>					Type/terminal: DTM No./poles: 4 Plug: Female
					
192612 Secondary Lock Std pkg 10 Servicing: HC-CARGO 192600, 193362 <i>WM 4P.</i>					Type/terminal: DTM No./poles: 4 Plug: Male
					
193107 Rubber Boot Std pkg 5 Servicing: HC-CARGO 192600					Type/terminal: DTM Colour: Grey No./poles: 4
					

193108 Rubber Boot Std pkg 5 Servicing: HC-CARGO 192599



Type/terminal: DTM
Colour: Grey
No./poles: 4

6 POLE

192601 DTM Connector Std pkg 5 Servicing: HC-CARGO 193363

DTM06-6S. Terminal: HC-CARGO 192620. Secondary lock: HC-CARGO 192613. Rubber Boot: HC-CARGO 193110.



Type/terminal: DTM
Colour: Grey
No./poles: 6
Plug: Female

192602 DTM Connector Std pkg 5 Servicing: HC-CARGO 193364

DTM04-6P. Terminal: HC-CARGO 192619. Secondary lock: HC-CARGO 192614. Rubber Boot: HC-CARGO 193109.



Type/terminal: DTM
Colour: Grey
No./poles: 6
Plug: Male

193363 DTM Connector kit Std pkg 1

Consists: 1x Connector: HC-CARGO 192601. 1x Secondary Lock: HC-CARGO 192613. 2x Terminal: HC-CARGO 192620.

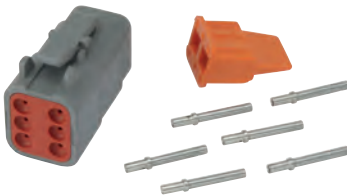

Type/terminal: DTM
Colour: Grey
No./poles: 6
Plug: Female

193364 DTM Connector kit Std pkg 1

Consists: 1x Connector: HC-CARGO 192602. 1x Secondary Lock: HC-CARGO 192614. 2x Terminal: HC-CARGO 192619.



Type/terminal: DTM
Colour: Grey
No./poles: 6
Plug: Male

ACCESSORIES

192613 Secondary Lock Std pkg 10 Servicing: HC-CARGO 192601, 193363

WM 6S.









Type/terminal: DTM
No./poles: 6
Plug: Female



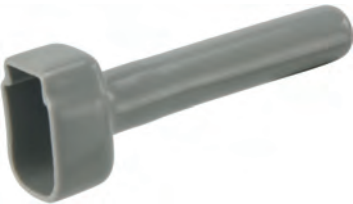



192614 Secondary Lock Std pkg 10 Servicing: HC-CARGO 192602, 193364





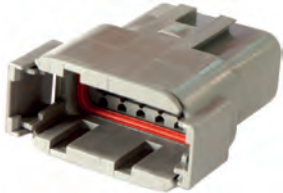

WM 6P.



Type/terminal: DTM
No./poles: 6
Plug: Male

		EL. SPECIFICATIONS	DIMENSIONS	ADDITIONAL SPECIFICATIONS
193109	Rubber Boot	Std pkg 5	Servicing: HC-CARGO 192602	Type/terminal: DTM Colour: Grey No./poles: 6
				
193110	Rubber Boot	Std pkg 5	Servicing: HC-CARGO 192601	Type/terminal: DTM Colour: Grey No./poles: 6
				
8 POLE				
192603	DTM Connector	Std pkg 5		Type/terminal: DTM Colour: Grey No./poles: 8 Plug: Female
<i>DTM06-8S. Terminal: HC-CARGO 192620. Secondary lock: HC-CARGO 192615. Rubber Boot: HC-CARGO 193112.</i>				
				
192604	DTM Connector	Std pkg 5		Type/terminal: DTM Colour: Grey No./poles: 8 Plug: Male
<i>DTM04-8P. Terminal: HC-CARGO 192619. Secondary lock: HC-CARGO 192616. Rubber Boot: HC-CARGO 193111.</i>				
				
ACCESSORIES				
192615	Secondary Lock	Std pkg 10	Servicing: HC-CARGO 192603	Type/terminal: DTM No./poles: 8 Plug: Female
<i>WM 8S.</i>				
				
192616	Secondary Lock	Std pkg 10	Servicing: HC-CARGO 192604	Type/terminal: DTM No./poles: 8 Plug: Male
<i>WM 8P.</i>				
				
193111	Rubber Boot	Std pkg 5	Servicing: HC-CARGO 192604	Type/terminal: DTM Colour: Grey No./poles: 8
				

		EL. SPECIFICATIONS	DIMENSIONS	ADDITIONAL SPECIFICATIONS
193112	Rubber Boot	Std pkg 5	Servicing: HC-CARGO 192603	
				Type/terminal: DTM Colour: Grey No./poles: 8
12 POLE				
192605	DTM Connector	Std pkg 5		
<i>DTM06-12P. Terminal: HC-CARGO 192620. Secondary lock: HC-CARGO 192617. Rubber Boot: HC-CARGO 193114.</i>				
				Type/terminal: DTM Colour: Grey No./poles: 12 Plug: Female
192606	DTM Connector	Std pkg 5		
<i>DTM04-12P. Terminal: HC-CARGO 192619. Secondary lock: HC-CARGO 192618. Rubber Boot: HC-CARGO 193113.</i>				
				Type/terminal: DTM Colour: Grey No./poles: 12 Plug: Male
ACCESSORIES				
192617	Secondary Lock	Std pkg 10	Servicing: HC-CARGO 192605	
<i>WM 12S.</i>				
				Type/terminal: DTM No./poles: 12 Plug: Female
192618	Secondary Lock	Std pkg 10	Servicing: HC-CARGO 192606	
<i>WM 12P.</i>				
				Type/terminal: DTM No./poles: 12 Plug: Male
193113	Rubber Boot	Std pkg 5	Servicing: HC-CARGO 192606	
				Type/terminal: DTM Colour: Grey No./poles: 12
193114	Rubber Boot	Std pkg 5	Servicing: HC-CARGO 192605	
				Type/terminal: DTM Colour: Grey No./poles: 12

ACCESSORIES			
192788	Sealing Plug	Std pkg 10	Servicing: DTM - Visit our web catalogue for further information
			
DEUTSCH-CONNECTOR DTP			
2 POLE			
193017	DTP Connector	Std pkg 1	
DTP 04-2P. Terminal: HC-CARGO 192621. Secondary lock: HC-CARGO 193021. Rubber Boot: HC-CARGO 193115.			
			Type/terminal: DTP No./poles: 2 Plug: Male
193018	DTP Connector	Std pkg 1	
DTP06-2S. Terminal: HC-CARGO 192622. Secondary lock: HC-CARGO 193022. Rubber Boot: HC-CARGO 193116.			
			Type/terminal: DTP No./poles: 2 Plug: Female
ACCESSORIES			
193021	Secondary Lock	Std pkg 10	Servicing: HC-CARGO 193017
WP 2P.			
			Type/terminal: DTP No./poles: 2 Plug: Male
193022	Secondary Lock	Std pkg 10	Servicing: HC-CARGO 193018
WP 2S.			
			Type/terminal: DTP No./poles: 2 Plug: Female
193115	Rubber Boot	Std pkg 5	Servicing: HC-CARGO 193017
			Type/terminal: DTP Colour: Grey No./poles: 2
193116	Rubber Boot	Std pkg 5	Servicing: HC-CARGO 193018
			Type/terminal: DTP Colour: Grey No./poles: 2

4 POLE
193019 DTP Connector Std pkg 1

DTP04-4P. Terminal: HC-CARGO 192621. Secondary lock: HC-CARGO 193023. Rubber Boot: HC-CARGO 193117.

 Type/terminal: DTP
 No./poles: 4
 Plug: Male

193020 DTP Connector Std pkg 1

DTP06-4S. Terminal: HC-CARGO 192622. Secondary lock: HC-CARGO 193024. Rubber Boot: HC-CARGO 193118.

 Type/terminal: DTP
 No./poles: 4
 Plug: Female

ACCESSORIES
193023 Secondary Lock Std pkg 10 Servicing: HC-CARGO 193019

WP 4P.

 Type/terminal: DTP
 No./poles: 4
 Plug: Male

193024 Secondary Lock Std pkg 10 Servicing: HC-CARGO 193020

WP 4S.

 Type/terminal: DTP
 No./poles: 4
 Plug: Female

193117 Rubber Boot Std pkg 5 Servicing: HC-CARGO 193019

 Type/terminal: DTP
 Colour: Grey
 No./poles: 4

193118 Rubber Boot Std pkg 5 Servicing: HC-CARGO 193020

 Type/terminal: DTP
 Colour: Grey
 No./poles: 4

DEUTSCH-CONNECTOR ACCESSORIES
192987 Mounting Bracket Std pkg 10

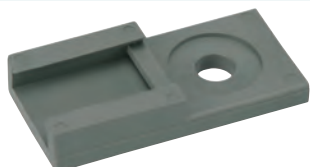
Fits on DT, DTM, DTP and DTHD.

DEUTSCH-CONNECTOR HD		
9 POLE		
193042 HD Connector <i>HD16-9-1939SE. Terminal: 9x HC-CARGO 192505.</i>	Std pkg 1 Servicing: HC-CARGO 193043	
	Amp: 13	Type/terminal: HD16-connector No./poles: 9 Plug: Female
193043 HD Connector <i>HD10-9-1939PE. Terminal: 9x HC-CARGO 192506.</i>	Std pkg 1 Servicing: HC-CARGO 193042	
	Amp: 13	Type/terminal: HD10-connector No./poles: 9 Plug: Male
DEUTSCH-CONNECTOR HDP		
9 POLE		
193044 HDP Connector <i>HDP-26-24-95N. Terminal: 6x HC-CARGO 192621, 2x HC-CARGO 193233, 1x HC-CARGO 193234.</i>	Std pkg 1 Servicing: HC-CARGO 193045	
	Amp: 25-100	Type/terminal: HDP26-connector No./poles: 9 Plug: Female
193045 HDP Connector <i>HDP24-24-9PN. Terminal: 6x HC-CARGO 192622, 2x HC-CARGO 193235, 1x HC-CARGO 193236.</i>	Std pkg 1 Servicing: HC-CARGO 193044	
	Amp: 25-100	Type/terminal: HDP24-connector No./poles: 9 Plug: Male
23 POLE		
192651 HDP Connector <i>HDP26-24-23-PE. Terminals: 23x HC-CARGO 192505, 192477, 192622. Seal 23x HC-CARGO 192787.</i>	Std pkg 1	
	Amp: 13	Type/terminal: HDP26-connector No./poles: 23 Plug: Male
192652 HDP Connector <i>HDP24-24-23-SE. Terminals: 23x HC-CARGO 192506, 192478. Seal: 23x HC-CARGO 192787. Panel Nut: HC-Cargo 192683.</i>	Std pkg 1	
	Amp: 13	Type/terminal: HDP26-connector No./poles: 23 Plug: Female

31 POLE

192655 HDP Connector Std pkg 1

HDP26-24-31-PE. Terminals: 31x HC-CARGO 192505, 192477. Seal: 31x HC-CARGO 192787.



Amp: 13

Type/terminal: HDP26-connector
No./poles: 31
Plug: Male

192656 HDP Connector Std pkg 1

HDP24-24-31-SE. Terminals: 31x HC-CARGO 192506, 192478. Seal: 31x HC-CARGO 192787. Panel Nut: HC-Cargo 192683.



Amp: 13

Type/terminal: HDP26-connector
No./poles: 31
Plug: Female

ACCESSORIES

192683 Panel Nut Std pkg 1 Servicing: HC-CARGO 192652, 192656

HDP26-connectors. ID: UNF 1 11/16".



192787 Sealing Plug Std pkg 10 Servicing: HC-CARGO 192651, 192652, 192655, 192656



SUPERSEAL

1 POLE

192077 Superseal Connector Std pkg 10

Terminal: HC-CARGO 192089. Single wire seal: HC-CARGO 192587, 192091.



Cable dia.: 1.5 mm

Type/terminal: Super Seal Connector
Colour: Black
No./poles: 1
Plug: Male

192078 Superseal Connector Std pkg 10

Terminal: HC-CARGO 192090. Single wire seal: HC-CARGO 192587, 192091.



Cable dia.: 1.5 mm

Type/terminal: Super Seal Connector
Colour: Black
No./poles: 1
Plug: Female

EL. SPECIFICATIONS		DIMENSIONS	ADDITIONAL SPECIFICATIONS
193266 Superseal Connector Std pkg 5			
<i>Terminal: HC-CARGO 192373. Single wire seal: HC-CARGO 192091.</i>			
		Cable dia.: 2.8 mm	Type/terminal: Super Seal Connector Colour: Black No./poles: 1 Plug: Male
193267 Superseal Connector Std pkg 5			
<i>Terminal: HC-CARGO 192374. Single wire seal: HC-CARGO 192091.</i>			
		Cable dia.: 2.8 mm	Type/terminal: Super Seal Connector Colour: Black No./poles: 1 Plug: Female
2 POLE			
192079 Superseal Connector Std pkg 10			
<i>Terminal: HC-CARGO 192089. Single wire seal: HC-CARGO 192587, 192091.</i>			
		Cable dia.: 1.5 mm	Type/terminal: Super Seal Connector Colour: Black No./poles: 2 Plug: Male
192080 Superseal Connector Std pkg 10			
<i>Terminal: HC-CARGO 192090. Single wire seal: HC-CARGO 192587, 192091.</i>			
		Cable dia.: 1.5 mm	Type/terminal: Super Seal Connector Colour: Black No./poles: 2 Plug: Female
193268 Superseal Connector Std pkg 5			
<i>Terminal: HC-CARGO 192373. Single wire seal: HC-CARGO 192091.</i>			
		Cable dia.: 2.8 mm	Type/terminal: Super Seal Connector Colour: Black No./poles: 2 Plug: Male
193269 Superseal Connector Std pkg 5			
<i>Terminal: HC-CARGO 192374. Single wire seal: HC-CARGO 192091.</i>			
		Cable dia.: 2.8 mm	Type/terminal: Super Seal Connector Colour: Black No./poles: 2 Plug: Female
193272 Superseal Connector Std pkg 5			
<i>Supplied w/ terminals and wire seals.</i>			
		Cable dia.: 6.3 mm	Type/terminal: Super Seal Connector Colour: Grey No./poles: 2 Plug: Female

3 POLE

192081 Superseal Connector Std pkg 10

Terminal: HC-CARGO 192089. Single wire seal: HC-CARGO 192587, 192091.

Cable dia.: 1.5 mm

 Type/terminal: Super Seal Connector
 Colour: Black
 No./poles: 3
 Plug: Male

192082 Superseal Connector Std pkg 10

Terminal: HC-CARGO 192090. Single wire seal: HC-CARGO 192587, 192091.

Cable dia.: 1.5 mm

 Type/terminal: Super Seal Connector
 Colour: Black
 No./poles: 3
 Plug: Female

193270 Superseal Connector Std pkg 5

Terminal: HC-CARGO 192373. Single wire seal: HC-CARGO 192091.

Cable dia.: 2.8 mm

 Type/terminal: Super Seal Connector
 Colour: Black
 No./poles: 3
 Plug: Male

193271 Superseal Connector Std pkg 5

Terminal: HC-CARGO 192374. Single wire seal: HC-CARGO 192091.

Cable dia.: 2.8 mm

 Type/terminal: Super Seal Connector
 Colour: Black
 No./poles: 3
 Plug: Female

4 POLE

192083 Superseal Connector Std pkg 10

Terminal: HC-CARGO 192089. Single wire seal: HC-CARGO 192587, 192091.

Cable dia.: 1.5 mm

 Type/terminal: Super Seal Connector
 Colour: Black
 No./poles: 4
 Plug: Male

192084 Superseal Connector Std pkg 10

Terminal: HC-CARGO 192090. Single wire seal: HC-CARGO 192587, 192091.

Cable dia.: 1.5 mm

 Type/terminal: Super Seal Connector
 Colour: Black
 No./poles: 4
 Plug: Female

5 POLE

192085 Superseal Connector - 1,5 Std pkg 10

Terminal: HC-CARGO 192089. Single wire seal: HC-CARGO 192587, 192091.

Cable dia.: 1.5 mm

 Type/terminal: Super Seal Connector
 Colour: Black
 No./poles: 5
 Plug: Male

192086 Superseal Connector - 1,5 Std pkg 10

Terminal: HC-CARGO 192090. Single wire seal: HC-CARGO 192587, 192091.



Cable dia.: 1.5 mm

Type/terminal: Super Seal Connector
Colour: Black
No./poles: 5
Plug: Female

6 POLE

192087 Superseal Connector - 1,5 Std pkg 10

Terminal: HC-CARGO 192089. Single wire seal: HC-CARGO 192587, 192091.



Cable dia.: 1.5 mm

Type/terminal: Super Seal Connector
Colour: Black
No./poles: 6
Plug: Male

192088 Superseal Connector - 1,5 Std pkg 10

Terminal: HC-CARGO 192090. Single wire seal: HC-CARGO 192587, 192091.



Cable dia.: 1.5 mm

Type/terminal: Super Seal Connector
Colour: Black
No./poles: 6
Plug: Female

JUNIOR-TIMER CONNECTOR

2 POLE

192146 Junior Timer Connector Std pkg 10 Servicing: HC-CARGO 070203

Terminal: HC-CARGO 191551, 192155, 192175, 192176. Rubber boot: HC-CARGO 192150, 192151. Wire seal: HC-CARGO 192177, 192178.



Type/terminal: Junior Timer
Colour: Black
No./poles: 2
Plug: Female

192166 Junior Timer Connector Std pkg 10

Terminal: HC-CARGO 192174.



Type/terminal: Junior Timer
Colour: Black
No./poles: 2
Plug: Male

192884 Holder Std pkg 10

Terminals: HC-CARGO 191551, 192155, 192175, 192176. Wire deal: HC-CARGO 192177, 192178. Rubber cap: HC-CARGO 192150, 192151.



Cable dia.: 2.5 mm

Colour: Black
No./poles: 2
Plug: Female

192902 Junior-Timer-Connector Std pkg 10

Plug 75. Terminal: HC-CARGO 192156, 192157, 192174, 192503. Wire seal: HC-CARGO 192177, 192178. Terminal: HC-CARGO 192998.



Type/terminal: Junior Timer
Colour: Black
No./poles: 2
Plug: Male

7 POLE

192149 Junior Timer Connector Std pkg 10

Terminal: HC-CARGO 191551, 192155, 192175, 192176. Rubber boot: HC-CARGO 192154. Wire seal: HC-CARGO 192177, 192178.



Type/terminal: Junior Timer
Colour: Black
No./poles: 7
Plug: Female

JUNIOR-POWER-TIMER CONNECTOR

2 POLE

192147 Junior Power Timer Connector Std pkg 10

Terminal: HC-CARGO 191551, 192155, 192175, 192176. Wire seal: HC-CARGO 192177, 192178. Rubber boot: HC-CARGO 192152.



Type/terminal: Junior Power Timer
Colour: Black
No./poles: 2
Plug: Female

192167 Junior Power Timer Connector Std pkg 10

Terminal: HC-CARGO 192156, 192157, 192174, 192503. Wire seal: HC-CARGO 192177, 192178.



Type/terminal: Junior Power Timer
Colour: Black
No./poles: 2
Plug: Male

192502 Junior Power Timer Connector Std pkg 10

Terminal: HC-CARGO 192156, 192157, 192174, 192503. Wire seal: HC-CARGO 192177, 192178. Rubber boot: HC-CARGO 192150, 192151.



Type/terminal: Junior Power Timer
Colour: Black
No./poles: 2
Plug: Male

193119 Junior Power Timer Connector Std pkg 10

Terminal: HC-CARGO 191551, 192155, 192175, 192176. Wire seal: HC-CARGO 192177, 192178. LED Adapter: HC-CARGO 171835.



Type/terminal: Junior Power Timer
Colour: Black
No./poles: 2
Plug: Female

3 POLE

192148 Junior Power Timer Connector Std pkg 10 Servicing: HC-CARGO 193241

Terminal: HC-CARGO 191551, 192155, 192175, 192176. Wire seal: HC-CARGO 192177, 192178. Rubber boot: HC-CARGO 192153.



Type/terminal: Junior Power Timer
Colour: Black
No./poles: 3
Plug: Female

193241 Junior Power Timer Connector Std pkg 10 Servicing: HC-CARGO 192148

Terminal: HC-CARGO 192156, 192157, 192174, 192503. Wire seal: HC-CARGO 192177, 192178.



Type/terminal: Junior Power Timer
Colour: Black
No./poles: 3
Plug: Male

4 POLE

192171 Junior Power Timer Connector Std pkg 10

Terminal: HC-CARGO 191551, 192155, 192175, 192176. Wire seal: HC-CARGO 192177, 192178.



Type/terminal: Junior Power Timer
Colour: Black
No./poles: 4
Plug: Female

5 POLE

192172 Junior Power Timer Connector Std pkg 10

Terminal: HC-CARGO 191551, 192155, 192175, 192176. Wire seal: HC-CARGO 192177, 192178.



Type/terminal: Junior Power Timer
Colour: Black
No./poles: 5
Plug: Female

6 POLE

192173 Junior Power Timer Connector Std pkg 10

Terminal: HC-CARGO 191551, 192155, 192175, 192176. Wire seal: HC-CARGO 192177, 192178.



Type/terminal: Junior Power Timer
Colour: Black
No./poles: 6
Plug: Female

JUNIOR-POWER-TIMER ACCESSORIES

192150 Rubber Boot Std pkg 10 Servicing: HC-CARGO 192502, 192146, 192884

Length: 57 mm



192151 Rubber Boot Std pkg 10 Servicing: HC-CARGO 192502, 192146, 192884			
<i>For 2 pole Junior-Timer connector.</i>			
		Length: 37 mm	
192152 Rubber Boot Std pkg 10 Servicing: HC-CARGO 192147			
<i>For 2 pole junior-timer connector. Angled.</i>			
		Length: 48 mm	
192153 Rubber Boot Std pkg 10 Servicing: HC-CARGO 192148			
<i>For 3 pole junior-powertimer connector.</i>			
		Length: 57 mm	
192154 Rubber Boot Std pkg 10 Servicing: HC-CARGO 192149			
<i>For 7 pole junior-timer connector.</i>			
		Length: 57 mm	

TOOLS

EXTRACTION

210643 Ejection Tool Std pkg 1			
<i>For round lug w/ locking tab. For 6.5 mm mounting and dismantability bushing. Dismounting Bushes: HC-CARGO 210644. Contact Insertion Sleeve: HC-CARGO 210645.</i>			
			
210661 Ejection Tool Std pkg 1 Servicing: HC-CARGO 210675			
<i>For round lug w/ locking tab. For 3.3 mm dismantability bushing.</i>			
			
210667 Ejection Tool Std pkg 1 Servicing: HC-CARGO 210675			
<i>For flat terminals w/ locking tongues for 3.3 mm receptacle.</i>			
			

		EL. SPECIFICATIONS	DIMENSIONS	ADDITIONAL SPECIFICATIONS
210851	Ejection Tool	Std pkg 1	Servicing: Round terminal, Mini universal - Visit our web catalogue for further information	
				
210918	Ejection Tool	Std pkg 1	For Micro Timer II terminals.	
				
210919	Ejection Tool	Std pkg 1	To 2.8 mm standard lugs, 6.3 mm standard lugs and Junior Timer lugs.	
				
210921	Ejection Tool	Std pkg 1	Servicing: HC-CARGO 804081	
For junior power timer (male and female lugs) and the standard power timer (male and female lugs). Spare Blade: HC-CARGO 211017, 211018.				
				
SETS				
210672	Kabelex Tool Set	Std pkg 1	For round plug connector in the plastic box. Contains 10 pcs: 1 pcs. of HC-CARGO 210661, 1 pcs. of HC-CARGO 210662, 1 pcs. of HC-CARGO 210643, 2 pcs. of HC-CARGO 210664, 2 pcs. of HC-CARGO 210665, 2 pcs. of HC-CARGO 210644, 1 pcs. of HC-CARGO 210645.	
				
210675	Kabelex Tool Set	Std pkg 1	For flat plug connector. Ejection Tool: HC-CARGO 210667, 210661.	
				
SPARE BLADES				
211017	Spare Blade	Std pkg 2	Servicing: HC-CARGO 210921 old model	
				

211018 Spare Blade Std pkg 2 Servicing: HC-CARGO 210921 old model



FOR DEUTSCH-CONNECTOR TERMINALS

210973 Crimping Tools Std pkg 1 Servicing: Universal crimp tool for solid terminals, DEUTSCH etc - Visit our web catalogue for further information



Dim.: 0.5-2 mm²

211051 Contact Removal Tool Std pkg 2

For DEUTSCH 0.2-0.5 mm². DEUTSCH 0411-240-2005.



211052 Contact Removal Tool Std pkg 2

For DEUTSCH 1-2 mm². DEUTSCH 0411-240-1605.



211053 Contact Removal Tool Std pkg 2

Deutsch. (2-3 mm²).



211120 Contact Removal Tool Std pkg 1 Servicing: Deutsch DTM, Deutsch 13760 DT RT1 - Visit our web catalogue for further information



211127 Contact Removal Tool Std pkg 1

For DEUTSCH 13 mm².



3 POLE

132804 Plug Kit Std pkg 1

HC-CARGO 190725 - 1, HC-CARGO 190726 - 2.



Type/terminal: Flat
Colour: Black
No./poles: 3
Plug: Female

192871 Connector Std pkg 10

Terminal: HC-CARGO 192411.



Colour: Black
No./poles: 3
Plug: Female

4 POLE

190762 Connector Std pkg 1 Servicing: Bosch Alternators - Visit our web catalogue for further information

Terminal: HC-CARGO 190252.



Colour: Black
No./poles: 4
Plug: Female

POWER

1 POLE

191405 Power Connector Std pkg 4

Terminal: HC-CARGO 191263, -264, -983.



Amp: 150

No./poles: 1
Plug: Male

191406 Power Connector Std pkg 4

Terminal: HC-CARGO 191260, -261, -262.



Amp: 150

No./poles: 1
Plug: Female

2 POLE

191407 Power Connector Std pkg 4

Terminal: HC-CARGO 191263, -264, -983.

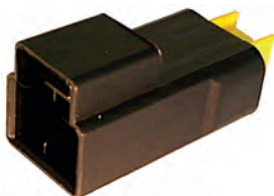

Amp: 150

No./poles: 2
Plug: Male

191408 Power Connector Std pkg 4

Terminal: HC-CARGO 191260, -261, -262.



Amp: 150

 No./poles: 2
 Plug: Female

4 POLE
181545 Connector Std pkg 1 Servicing: HC-CARGO 181476

DIN 72585.



Amp: 30

 Colour: Black
 No./poles: 4
 Plug: Male

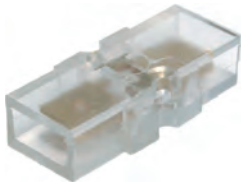
CABLES
FLAT TONGUE
190043 Butt Splices Std pkg 25

Width: 6.3 mm

 Terminal type: Flat
 Out: 1
 Plugs in: 1

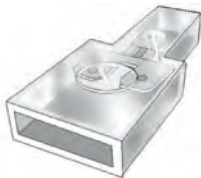
190776 Butt Splices Std pkg 50

Width: 6.3 mm

 Terminal type: Flat
 Out: 2
 Plugs in: 1

190956 Butt Splices Std pkg 10

Strip of 12.



Width: 6.3 mm

Terminal type: Flat

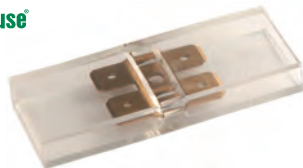
192648 Butt Splices Std pkg 25

Width: 6.3 mm

 Terminal type: Flat
 Out: 3
 Plugs in: 1

WIRE NUTS
RED
191076 Cable Connector Std pkg 50

 Dim.: 1-2 mm²
 Dim 2: 0.5-1 mm²

Material: PP

EL. SPECIFICATIONS		DIMENSIONS	ADDITIONAL SPECIFICATIONS
191077 Cable Connector Std pkg 50			
		Dim.: 0.5-1 mm ² Width: 19.4 mm	Material: PP
191485 Cable Connector Std pkg 50			
<i>Cable Connector: HC-CARGO 190876, 191498.</i>			
		Dim.: 0.5-1 mm ²	Material: Nylon
BLUE			
190875 Cable Connector Std pkg 50			
<i>Cable Connector: HC-CARGO 190876.</i>			
		Dim.: 1.5-2.5 mm ² Width: 9.5 mm	Material: Nylon
190971 Cable Connector Std pkg 50			
		Dim.: 1.5-2.5 mm ² Width: 20.4 mm	Material: PP
BROWN			
191484 Cable Connector Std pkg 50			
		Dim.: 2.5-4 mm ² Dim 2: 0.75-2.5 mm ² Width: 21.1 mm	Material: PP
RED TRANSPARENT			
191498 Cable Connector Std pkg 50 Servicing: HC-CARGO 191485			
<i>6.3 mm.</i>			
		Dim.: 0.5-1.5 mm ²	Terminal type: Male
TRANSPARENT			
190876 Cable Connector Std pkg 50 Servicing: HC-CARGO 190875, 191485			
<i>6.3 mm.</i>			
		Dim.: 1.5-2.5 mm ²	Terminal type: Male

SCREW TERMINAL
190195 Cable Connector Std pkg 10

Number of 12. Max 24 A.

 Dim.: 2.5 mm²

Terminal type: Screw

190196 Cable Connector Std pkg 10

Number of 12. Max 32 A.

 Dim.: 4-6 mm²

Terminal type: Screw

190197 Cable Connector Std pkg 10

Number of 12. Max 76 A.

 Dim.: 16 mm²

Terminal type: Screw

190911 Cable Connector Std pkg 10

Number of 12. Max 41 A.

 Dim.: 10 mm²

Terminal type: Screw

191756 Butt Splices Std pkg 1

8x6 terminalblock. 25 A. Terminal width: 6.3 mm

 Dist. mount. holes:
99 mm

 Terminal type: Flat
Material: Polycarbonate
Out: 8
Plugs in: 8

191771 Butt Splices Std pkg 1

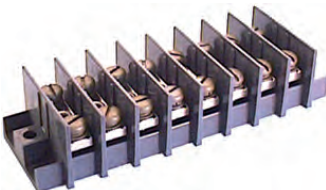
1x8 20 A.

 Dist. mount. holes:
99 mm







 Terminal type: Screw
Material: Polycarbonate
Out: 8
Plugs in: 8

193011 Terminal Block Std pkg 1

25 A. Terminal width: 6.3 mm.

 Dist. mount. holes:
77.3 mm

 Terminal type: Flat
Material: Polycarbonate
Out: 6
Plugs in: 6

BATTERY TERMINALS			
BRASS CASTING			
25-35 MM ²			
192368	Battery Terminal	Std pkg 5	
			Length: 46 mm Cable size/max: 35 mm ² Cable size/min: 25 mm ² Polarity: Positive
			Material: Moulded brass Alternativ no.: 190012
192369	Battery Terminal	Std pkg 5	
			Length: 46 mm Cable size/max: 35 mm ² Cable size/min: 25 mm ² Polarity: Negative
			Material: Moulded brass Alternativ no.: 190013
W/ 10 MM BOLT			
192400	Battery Terminal	Std pkg 5	
			Length: 54 mm Cable size/max: 70 mm ² Cable size/min: 10 mm ² Cable connection: 10 mm bolt Polarity: Positive
			Material: Moulded brass Alternativ no.: 190213
192401	Battery Terminal	Std pkg 5	
			Length: 54 mm Cable size/max: 70 mm ² Cable size/min: 10 mm ² Cable connection: 10 mm bolt Polarity: Negative
			Material: Moulded brass Alternativ no.: 190214
TIN PLATED			
190213	Battery Terminal	Std pkg 5	
			ID: 18.5 mm Cable size/max: 70 mm ² Cable size/min: 10 mm ² Cable connection: 10 mm bolt Polarity: Positive
			Material: Moulded brass Tin plated: Yes Alternativ no.: 192400
190214	Battery Terminal	Std pkg 5	
			ID: 15.9 mm Cable size/max: 70 mm ² Cable size/min: 10 mm ² Cable connection: 10 mm bolt Polarity: Negative
			Material: Moulded brass Tin plated: Yes Alternativ no.: 192401

W/ M6 BOLT AND WING NUT
TIN PLATED
191134 Battery Terminal Std pkg 5

w/ wing nut.

 ID: 15.9 mm
 Cable size/max: 70 mm²
 Cable size/min: 6 mm²
 Cable connection: 8 mm bolt
 Polarity: Negative

 Material: Moulded brass
 Tin plated: Yes
 Alternativ no.: 192403

W/ M10 BOLT AND WING NUT
192402 Battery Terminal Std pkg 5

w/ wing nut.

 Length: 54 mm
 Cable size/max: 70 mm²
 Cable size/min: 10 mm²
 Pole size: 18 mm
 Cable connection: 10 mm bolt
 Polarity: Positive

 Material: Moulded brass
 Alternativ no.: 191133

192403 Battery Terminal Std pkg 5

w/ wing nut.

 Length: 54 mm
 Cable size/max: 70 mm²
 Cable size/min: 10 mm²
 Pole size: 16 mm
 Cable connection: 10 mm bolt
 Polarity: Negative

 Material: Moulded brass
 Alternativ no.: 191134

TIN PLATED
191133 Battery Terminal Std pkg 5

w/ wing nut.

 ID: 18.5 mm
 Cable size/max: 70 mm²
 Cable size/min: 10 mm²
 Cable connection: 10 mm bolt
 Polarity: Positive

 Material: Moulded brass
 Tin plated: Yes
 Alternativ no.: 192402

25 MM²
192163 Battery Terminal Std pkg 5

 ID: 19 mm
 Cable size/max: 25 mm²
 Polarity: Positive

Material: Moulded brass

192164 Battery Terminal Std pkg 5

 ID: 17 mm
 Cable size/max: 25 mm²
 Polarity: Negative

Material: Moulded brass

EL. SPECIFICATIONS		DIMENSIONS		ADDITIONAL SPECIFICATIONS	
W/ SWITCH					
192493 Battery Terminal		Std pkg 1			
				Polarity: Negative Switch: w/ Material: Moulded brass Cable w/fuse: Yes	
16-35 MM²					
TIN PLATED					
190012 Battery Terminal		Std pkg 5			
				ID: 18.5 mm Cable size/max: 35 mm ² Cable size/min: 16 mm ² Cable connection: 8 mm bolt Polarity: Positive	
190013 Battery Terminal		Std pkg 5			
				ID: 15.9 mm Cable size/max: 35 mm ² Cable size/min: 16 mm ² Cable connection: 8 mm bolt Polarity: Negative	
190211 Battery Terminal		Std pkg 5		Servicing: Fiat, Mazda, Suzuki, Nissan - Visit our web catalogue for further information	
				ID: 13 mm Cable size/max: 35 mm ² Cable size/min: 16 mm ² Polarity: Positive	
190212 Battery Terminal		Std pkg 5		Servicing: Fiat, Mazda, Suzuki, Nissan - Visit our web catalogue for further information	
				ID: 11.2 mm Cable size/max: 35 mm ² Cable size/min: 16 mm ² Polarity: Negative	
35-70 MM²					
TIN PLATED					
191166 Battery Terminal		Std pkg 5			
				ID: 18.5 mm Cable size/max: 70 mm ² Cable size/min: 35 mm ² Polarity: Positive	
191167 Battery Terminal		Std pkg 5			
				ID: 15.9 mm Cable size/max: 70 mm ² Cable size/min: 35 mm ² Polarity: Negative	

35-95 MM²
TIN PLATED
193000 Battery Terminal Std pkg 5

Heavy duty.

 ID: 18.5 mm
 Cable size/max: 95 mm²
 Cable size/min: 35 mm²
 Polarity: Positive

 Material: Moulded brass
 Tin plated: Yes

193001 Battery Terminal Std pkg 5

Heavy duty.

 ID: 15.9 mm
 Cable size/max: 95 mm²
 Cable size/min: 35 mm²
 Polarity: Negative

 Material: Moulded brass
 Tin plated: Yes

TIN PLATED W/DOUBLE SCREW
190866 Battery Terminal Std pkg 5

w/ double screws and screw for AUX.

 ID: 18.5 mm
 Cable size/max: 95 mm²
 Cable size/min: 35 mm²
 Cable connection: Dual
 Polarity: Positive

 Material: Moulded brass
 Tin plated: Yes

190867 Battery Terminal Std pkg 5

w/ double screws and screw for AUX.

 ID: 15.9 mm
 Cable size/max: 95 mm²
 Cable size/min: 35 mm²
 Cable connection: Dual
 Polarity: Negative

 Material: Moulded brass
 Tin plated: Yes

35 MM²
TIN PLATED
191244 Battery Terminal Std pkg 5









 ID: 18.5 mm
 Cable size/max: 35 mm²
 Cable size/min: 35 mm²
 Polarity: Positive







 Material: Moulded brass
 Tin plated: Yes







191245 Battery Terminal Std pkg 5

 ID: 15.9 mm
 Cable size/max: 35 mm²
 Cable size/min: 35 mm²
 Polarity: Negative

 Material: Moulded brass
 Tin plated: Yes



50 MM ²		
TIN PLATED		
190202 Battery Terminal	Std pkg 5	
		ID: 18.5 mm Cable size/max: 50 mm ² Cable size/min: 50 mm ² Polarity: Positive
		Material: Moulded brass Tin plated: Yes
190203 Battery Terminal	Std pkg 5	
		ID: 15.9 mm Cable size/max: 50 mm ² Cable size/min: 50 mm ² Polarity: Negative
		Material: Moulded brass Tin plated: Yes
70 MM ²		
TIN PLATED		
191989 Battery Terminal	Std pkg 5	
		ID: 18.5 mm Cable size/max: 70 mm ² Cable size/min: 70 mm ² Polarity: Positive
		Material: Moulded brass Tin plated: Yes
191990 Battery Terminal	Std pkg 5	
		ID: 15.9 mm Cable size/max: 70 mm ² Cable size/min: 70 mm ² Polarity: Negative
		Material: Moulded brass Tin plated: Yes
193166 Battery Terminal	Std pkg 5	
		Length: 50 mm Cable size/max: 70 mm ² Cable size/min: 10 mm ² Polarity: Positive
		Material: Moulded brass No./connections: 2 Tin plated: Yes
193167 Battery Terminal	Std pkg 5	
		Length: 50 mm Cable size/max: 70 mm ² Cable size/min: 10 mm ² Polarity: Negative
		Material: Moulded brass No./connections: 2 Tin plated: Yes
ACCESSORIES		
190215 Nut & Bolt	Std pkg 100	
		Collar length: 38 mm
		Material: Moulded brass
192681 Terminal Cover	Std pkg 10	
		Cable dia.: 17 mm Length: 52 mm Width: 35 mm
		Colour: Red Material: PVC

EL. SPECIFICATIONS		DIMENSIONS	ADDITIONAL SPECIFICATIONS
192682 Terminal Cover	Std pkg 10		
		Cable dia.: 17 mm Length: 52 mm Width: 35 mm	Colour: Black Material: PVC
192888 Terminal Cover Right	Std pkg 10		
<i>Right +.</i>			
		Cable dia.: 17 mm Length: 52 mm Height: 22 mm Width: 35 mm	Colour: Red Material: PVC
192889 Terminal Cover Left	Std pkg 10		
<i>Left -.</i>			
		Cable dia.: 17 mm Length: 52 mm Height: 22 mm Width: 35 mm	Colour: Black Material: PVC
192890 Terminal Cover Left	Std pkg 10		
<i>Left +.</i>			
		Cable dia.: 17 mm Length: 52 mm Height: 22 mm Width: 35 mm	Colour: Red Material: PVC
192891 Terminal Cover Right	Std pkg 10		
<i>Right -.</i>			
		Cable dia.: 17 mm Length: 52 mm Height: 22 mm Width: 35 mm	Colour: Black Material: PVC
FORMPRESSED			
25-40 MM²			
17 MM			
192075 Battery Terminal	Std pkg 5		
		ID: 17 mm Cable size/max: 40 mm ² Cable size/min: 25 mm ² Polarity: Negative	Material: Compressed No./connections: 1
192076 Battery Terminal	Std pkg 5		
<i>For M8 stud connection.</i>			
		ID: 17 mm Cable size/max: 40 mm ² Cable size/min: 25 mm ² Polarity: Positive	Material: Compressed No./connections: 1





19 MM		
191820	Battery Terminal	Std pkg 1
		ID: 19 mm Cable size/max: 40 mm ² Cable size/min: 25 mm ² Polarity: Positive
		Material: Compressed No./connections: 2
3 TERMINAL OUTLETS		
191821	Battery Terminal	Std pkg 1
		ID: 19 mm Polarity: Positive
		Material: Compressed No./connections: 3
192234	Battery Terminal	Std pkg 1
		ID: 17 mm Polarity: Negative
		Material: Compressed No./connections: 3
10-20 MM ²		
17 MM		
192074	Battery Terminal	Std pkg 5
		ID: 17 mm Cable size/max: 20 mm ² Cable size/min: 10 mm ² Polarity: Negative
		Material: Compressed No./connections: 1
FOR FRENCH APPLICATIONS		
190253	Battery Terminal	Std pkg 5 Servicing: French applications - Visit our web catalogue for further information
		ID: 19 mm Polarity: Positive
		Colour: Red Material: Compressed
190254	Battery Terminal	Std pkg 5 Servicing: French applications - Visit our web catalogue for further information
		ID: 17 mm Polarity: Negative
		Colour: Green Material: Compressed
LEADS AND EARTH STRAPS		
190218	Battery Connection Cable	Std pkg 1
		Length: 300 mm Cable size/max: 35 mm ² Angled: 90° Polarity: Pos./Neg.
		No./wires: 1008/0.2

		EL. SPECIFICATIONS	DIMENSIONS	ADDITIONAL SPECIFICATIONS
190220	Earth Strap	Std pkg 1		
		Amp: 110	ID/eye: 1.14 mm Length: 200 mm Cable size/max: 22 mm ²	No./wires: 432/0.26
190221	Earth Strap	Std pkg 1		
		Amp: 110	ID/eye: 1.14 mm Length: 250 mm Cable size/max: 22 mm ²	No./wires: 432/0.26
190222	Earth Strap	Std pkg 1		
		Amp: 110	ID/eye: 1.14 mm Length: 300 mm Cable size/max: 22 mm ²	No./wires: 432/0.26
190223	Earth Strap	Std pkg 1		
		Amp: 110	ID/eye: 1.14 mm Length: 350 mm Cable size/max: 22 mm ²	No./wires: 432/0.26
190224	Earth Strap	Std pkg 1		
		Amp: 110	ID/eye: 1.14 mm Length: 400 mm Cable size/max: 22 mm ²	No./wires: 432/0.26
190225	Earth Strap	Std pkg 1		
		Amp: 110	ID/eye: 1.14 mm Length: 450 mm Cable size/max: 22 mm ²	No./wires: 432/0.26
190226	Earth Strap	Std pkg 1		
		Amp: 110	ID/eye: 1.14 mm Length: 500 mm Cable size/max: 22 mm ²	No./wires: 432/0.26

		EL. SPECIFICATIONS	DIMENSIONS	ADDITIONAL SPECIFICATIONS
190228	Earth Strap	Std pkg 2		
		Amp: 82	ID/eye: 1.14 mm Length: 200 mm Cable size/max: 16 mm ²	No./wires: 228/0.25
190229	Earth Strap	Std pkg 2		
		Amp: 82	ID/eye: 1.14 mm Length: 250 mm Cable size/max: 16 mm ²	No./wires: 228/0.25
190230	Earth Strap	Std pkg 2		
		Amp: 82	ID/eye: 1.14 mm Length: 350 mm Cable size/max: 16 mm ²	No./wires: 228/0.25
190231	Earth Strap	Std pkg 2		
		Amp: 82	ID/eye: 1.14 mm Length: 400 mm Cable size/max: 16 mm ²	No./wires: 228/0.25
190232	Earth Strap	Std pkg 2		
		Amp: 82	ID/eye: 1.14 mm Length: 450 mm Cable size/max: 16 mm ²	No./wires: 228/0.25
190235	Starter Cable	Std pkg 1		
			ID/eye: 1.04 mm Length: 300 mm Cable size/max: 25 mm ² Polarity: Positive	No./wires: 742/0.2
190237	Starter Cable	Std pkg 1		
			ID/eye: 1.04 mm Length: 500 mm Cable size/max: 25 mm ² Polarity: Positive	No./wires: 742/0.2

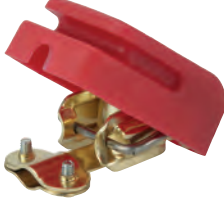
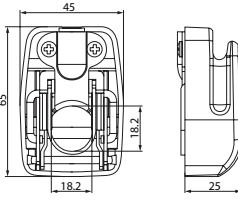
EL. SPECIFICATIONS		DIMENSIONS	ADDITIONAL SPECIFICATIONS
190239 Starter Cable	Std pkg 1		
		ID/eye: 1.04 mm Length: 700 mm Cable size/max: 25 mm ² Polarity: Positive	No./wires: 742/0.2
190242 Starter Cable	Std pkg 1		
		ID/eye: 1.04 mm Length: 1000 mm Cable size/max: 25 mm ² Polarity: Positive	No./wires: 742/0.2
191679 Battery Connection Cable	Std pkg 1		
		Length: 275 mm Cable size/max: 50 mm ² Angled: 90° Polarity: Pos./Neg.	No./wires: 378/0.41

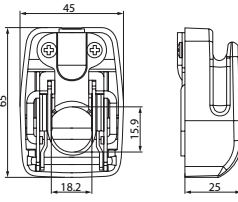
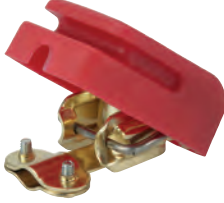
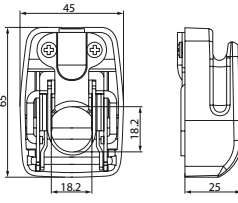
QUICK RELEASE TERMINAL

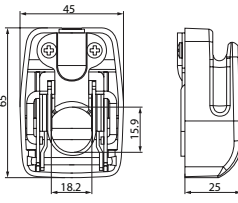
193369 Quick release terminal	Std pkg 1		
<i>Negative: HC-CARGO 193370.</i>			
		Dim.: 26x46x65.5 mm ID: 18.8 mm Cable size/max: 35 mm ² Angled: 0-45° Polarity: Positive	Colour: Red Material: Copper Tin plated: No Pcs.: 1 Alternativ no.: 193371
193370 Quick release terminal	Std pkg 1		
<i>Positive: HC-CARGO 193369.</i>			
		Dim.: 26x46x65.5 mm ID: 18.5 mm Cable size/max: 35 mm ² Angled: 0-45° Polarity: Negative	Colour: Blue Material: Copper Tin plated: No Pcs.: 1 Alternativ no.: 193372
193371 Quick release terminal	Std pkg 25		
<i>Negative: HC-CARGO 193372.</i>			
		Dim.: 26x46x65.5 mm ID: 18.8 mm Cable size/max: 35 mm ² Angled: 0-45° Polarity: Positive	Colour: Red Material: Copper Tin plated: No Pcs.: 25 Alternativ no.: 193369
193372 Quick release terminal	Std pkg 25		
<i>Positive: HC-CARGO 193371.</i>			
		Dim.: 26x46x65.5 mm ID: 18.5 mm Cable size/max: 35 mm ² Angled: 0-45° Polarity: Negative	Colour: Blue Material: Copper Tin plated: No Pcs.: 25 Alternativ no.: 193370

INDUSTRIAL BATTERY CONNECTORS

CB Series Details

	CB 50	CB 175	CB 350
	mm	mm	mm
A	19	28.5	28.5
B	6.4	11	35
C	18.2	27	35
D	36.5	55.6	69.8
E	47.6	79.4	108
F	80.9	133.3	182.6
G	11.5	19	27
H	15.9	25.4	33.3
J	3.7	6.7	6.7

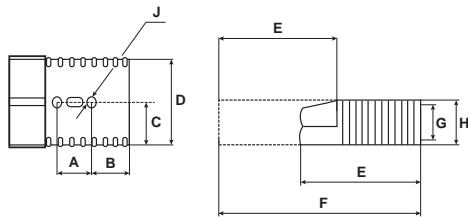

CBX Series Details

	CBX 175	CBX 350
	mm	mm
A	49.2	61.9
B	28.5	28.5
C	15.9	15.9
D	71.2	85.7
E	85.3	125.4
F	146.3	200
G	25.5	33.3

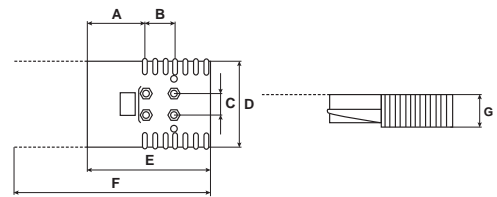

50 AMPERE

CB50	HC-CARGO	Std pkg	Max V	Amp	Temp. class °C	Colour	Cable size	Terminals	Handle	Dust cap
	180530	Pkg. 1	600	50	-40 - +125	Grey	6 mm ²	180390	180548	180516
	180531	Pkg. 1	600	50	-40 - +125	Red	6 mm ²	180390	180548	180516
	180532	Pkg. 1	600	50	-40 - +125	Black	6 mm ²	180390	180548	180516
	180381	Pkg. 1	600	50	-40 - +125	Grey	16 mm ²	180535	180548	180516
	180382	Pkg. 1	600	50	-40 - +125	Red	16 mm ²	180535	180548	180516
	180383	Pkg. 1	600	50	-40 - +125	Black	16 mm ²	180535	180548	180516

SPARE PARTS

180390 Terminals 	Std pkg 1	Servicing: HC-CARGO 180381, -382, -383 Voltage: 600 Amp: 50 Cable dim.: 16 mm ²
180535 Terminals 	Std pkg 1	Servicing: HC-CARGO 180530, -531, -532 Voltage: 600 Amp: 50 Cable dim.: 6 mm ²

ACCESSORIES

180548 Handle 	Std pkg 1	Servicing: HC-CARGO 180381, -382, -383, -530, -531, -532 Colour: Red
--------------------------	-----------	---

181516 Dust Cap Std pkg 1 Servicing: CB50

80 AMPERE

NF80	HC-CARGO	Std pkg	Max V	Amp	Temp. class	Colour	Heading type	Cable size
	180542	Pkg. 1	150	80	-20°C - +90°C	Black	Female	25 mm ²
	180543	Pkg. 1	150	80	-20°C - +90°C	Black	Male	25 mm ²
	180562	Pkg. 1	150	80	-20°C - +90°C	Black	Female	16 mm ²
	180563	Pkg. 1	150	80	-20°C - +90°C	Black	Male	16 mm ²

100 AMPERE

CB100	HC-CARGO	Std pkg	Max V	Amp	Temp. class	Colour	Heading type	Cable size	Handle
	181501	Pkg. 1	150	100	-20°C - +90°C	Black	Female	16 mm ²	181505 (R)
	181502	Pkg. 1	150	100	-20°C - +90°C	Black	Male	16 mm ²	181505 (R)
	181503	Pkg. 1	150	100	-20°C - +90°C	Black	Female	25 mm ²	181505 (R)
	181504	Pkg. 1	150	100	-20°C - +90°C	Black	Male	25 mm ²	181505 (R)

ACCESSORIES
181505 Handle Std pkg 1 Servicing: HC-CARGO 181501, 181502, 181503, 181504

Colour: Red

160 AMPERE

NF160	HC-CARGO	Std pkg	Max V	Amp	Temp. class °C	Colour	Heading type	Cable size	Reducing bush	Handle
	181519	Pkg. 1	150	160	-20 - +90	Black	Female	50 mm ²	181521	180380 (B)
	181520	Pkg. 1	150	160	-20 - +90	Black	Male	50 mm ²	181521	Already present

ACCESSORIES
180380 Handle Std pkg 1 Servicing: HC-CARGO 180395, 180396, 181519, 181520



Colour: Black

181521 Reducer Kit Std pkg 1 Servicing: HC-CARGO 181519, 181520

 Voltage: 150
 Amp: 160
 Cable dim.: 50/35 mm²

175 AMPERE											
CB175	HC-CARGO	Std pkg	Max V	Amp	Temp. class °C	Colour	Heading type	Cable size	Terminals	Handle	Dust cap
	180384	Pkg. 1	600	175	-40 - +125	Grey	Female	50 mm ²	180392	180549 (G) 180391 (R)	180517
	180385	Pkg. 1	600	175	-40 - +125	Red	Female	50 mm ²	180392	180549 (G) 180391 (R)	180517
	180537	Pkg. 1	600	175	-40 - +125	Grey	Female	50 mm ²	180554	180549 (G) 180391 (R)	
	180538	Pkg. 1	600	175	-40 - +125	Red	Female	50 mm ²	180554	180549 (G) 180391 (R)	
	180533	Pkg. 1	600	175	-40 - +125	Grey	Female	35 mm ²	180536	180549 (G) 180391 (R)	180517
	180534	Pkg. 1	600	175	-40 - +125	Red	Female	35 mm ²	180536	180549 (G) 180391 (R)	180517
SPARE PARTS											
180392 Terminals Std pkg 1 Servicing: HC-CARGO 180384, -385											
		Voltage: 600		Cable dim.: 50 mm ²							
		Amp: 175									
180536 Terminals Std pkg 1 Servicing: HC-CARGO 180533, 180534											
		Voltage: 600		Cable dim.: 35 mm ²							
		Amp: 175									
180554 Terminals Std pkg 1 Servicing: HC-CARGO 180537, -538											
		Voltage: 600		Cable dim.: 50 mm ²							
		Amp: 175									
ACCESSORIES											
180391 Handle Std pkg 1 Servicing: HC-CARGO 180533, -534, -537, -538, -384, -385											
				Colour: Red							
180549 Handle Std pkg 1 Servicing: HC-CARGO 180533, -534, -537, -538, -384, -385											
				Colour: Grey							
181517 Dust Cap Std pkg 1 Servicing: CB175											
											

250 AMPERE

Y250	HC-CARGO	Std pkg	Max V	Amp	Colour	Heading type	Cable size	Terminals	Handle	Self close lid
	180580	Pkg. 1	150	250	Yellow	Male	50 mm ²	180582	180328	181329
	180581	Pkg. 1	250	250	Black	Female	50 mm ²	180583	180328	181329

SPARE PARTS

181605 Terminals Std pkg 1 Servicing: HC-CARGO 180581

	Amp: 250	Gender: Female
---	----------	----------------

181606 Terminals Std pkg 1 Servicing: HC-CARGO 180580

	Amp: 250	Gender: Male
--	----------	--------------

ACCESSORIES

180582 Terminals Std pkg 1 Servicing: HC-CARGO 180580

Single delivered.

	Amp: 250	Gender: Male
---	----------	--------------

180583 Terminals Std pkg 1 Servicing: HC-CARGO 180581

Single delivered.

	Amp: 250	Gender: Female
---	----------	----------------

181328 Rubber Boot Std pkg 1 Servicing: HC-CARGO 180580

		Protection degree: IP 66
---	--	--------------------------

181329 Lid Std pkg 1 Servicing: HC-CARGO 180581



Self-closed.

		
---	--	--

300 AMPERE							
E300	HC-CARGO	Std pkg	Max V	Amp	Colour	Cable size	Terminals
	180575	Pkg. 1	250	300	Yellow	70 mm ²	w/brazed solid silver tip
	180577	Pkg. 1	250	300	Yellow	70 mm ²	w/brazed solid silver tip

320 AMPERE									
NF320	HC-CARGO	Std pkg	Max V	Amp	Temp. class °C	Colour	Heading type	Cable size	Aux terminals
	180395	Pkg. 1	150	320	-20 - +90	Black	Female	90/70 mm ²	180916
	180396	Pkg. 1	150	320	-20 - +90	Black	Male	90/70 mm ²	

ACCESSORIES		
180616 Terminals	Std pkg 1	Servicing: HC-CARGO 180395
	Voltage: 150 Amp: 160	Type: Female

350 AMPERE									
CB350	HC-CARGO	Std pkg	Max V	Amp	Temp. class °C	Colour	Heading type	Cable size	Handle
	180386	Pkg. 1	600	350	-40 - +125	Grey	Female	70 mm ²	180550 (G)
	180387	Pkg. 1	600	350	-40 - +125	Red	Female	70 mm ²	180550 (G)
CBX350	HC-CARGO	Std pkg	Max V	Amp	Temp. class °C	Colour	Heading type	Cable size	Handle
	180551	Pkg. 1	600	350	-40 - +125	Grey	Female	70 mm ²	180550 (G)
	180552	Pkg. 1	600	350	-40 - +125	Red	Female	70 mm ²	180550 (G)

ACCESSORIES		
180550 Handle	Std pkg 1	Servicing: HC-CARGO 180386, -387, 180551, -552
		Colour: Grey

PLUGS & SOCKETS

DIN AND CIGARETTE LIGHTER

160294 Cigarette Lighter Std pkg 1 Servicing: Audi, Opel, VW - Visit our web catalogue for further information

Universal.



Voltage: 12

Light: w/o

160300 Cigarette Lighter Std pkg 1

Universal.



Voltage: 12

Light: w/

160551 Cigarette Lighter Std pkg 1

Universal.



Voltage: 24

Light: w/

SOCKETS

160409 Lighter Socket Std pkg 1

Universal.



Voltage: 12-24
Amp: 20

Light: w/o
Cap: w/
Resistor: w/o
DIN norm: 53 505

161717 Lighter Socket Std pkg 1

Panel: HC-CARGO 181679, 181680, 181681.

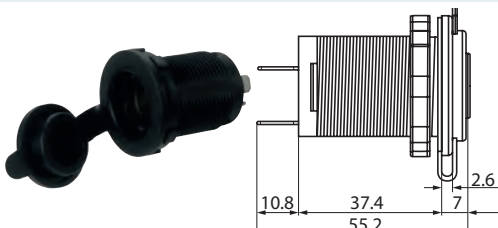

Voltage: 12/24
Amp: 20

ID/mount. hole: 29 mm

Cap: w/
Male/female: Female

180038 DIN Socket Std pkg 5

Standard DIN.



ID/mount. hole:
18.5 mm

Material: Nickel plated brass
No./mounting holes: 1
Cap: w/
Male/female: Female
DIN norm: 72591
ISO norm: 4165

EL. SPECIFICATIONS		DIMENSIONS	ADDITIONAL SPECIFICATIONS
180115 DIN Socket Std pkg 1 Universal. DIN Plug: HC-CARGO 180113.			
 		Dist. mount. holes: 46 mm	Material: Cast aluminum No./mounting holes: 2 No./poles: 2 Male/female: Female DIN norm: 72591 ISO norm: 4165
180157 DIN Socket Std pkg 5			
 		ID/mount. hole: 18.5 mm	Material: Nickel plated brass No./poles: 2 Cap: w/ Male/female: Female DIN norm: 72591 ISO norm: 4165
180354 Coupling Socket Std pkg 1 DIN - coupling socket extension connector, universal. Standard.			
			No./poles: 1 Male/female: Female
180376 DIN Socket Std pkg 5 Servicing: HC-CARGO 170292, 170387, 170788, 170789 Also used in sockets for beacons.			
 		ID/mount. hole: 18.5 mm	Material: Brass No./poles: 1 Male/female: Female DIN norm: 72591
180377 DIN Socket Std pkg 5 Servicing: HC-CARGO 170405, 170406, 170419, 170460, 170531, 170537, 170562, 171576 Also used in sockets for beacons.			
 		ID/mount. hole: 18.5 mm	Material: Brass No./poles: 2 Male/female: Female DIN norm: 72591
181275 DIN Socket Std pkg 5			
		ID/mount. hole: 18.5 mm	No./poles: 2 Cap: w/ Male/female: Female DIN norm: 72591 ISO norm: 4165 Alternativ no.: 180157
181548 Twin Socket Cigar Adapter Std pkg 1 w/ 60 cm cable.			
		Voltage: 12 Amp: 15	

	EL. SPECIFICATIONS	DIMENSIONS	ADDITIONAL SPECIFICATIONS
181549 Twin Socket Cigar Adapter Std pkg 1 	Voltage: 12 Amp: 15		
181550 Twin Socket Cigar Adapter Std pkg 1 <i>w/ 2 USB plugs. Cable lenght: 650 mm. USB Charging Kit: HC-CARGO 181602.</i>	Voltage: 12-24 Amp: 10		
181575 Socket Std pkg 1 <i>Universal. w/ 30 cm cable 0.8 mm².</i>			No./poles: 1 Male/female: Female
181601 USB Adapter Std pkg 1 <i>2 horizontally built-in ports, charging two USB devices simultaneously. USB Charging Kit: HC-CARGO 181602.</i>	Voltage: 12-24 Amp: 3		Material: PVC
181616 DIN Socket Std pkg 1 <i>300 mm cable.</i>	Voltage: 6-24 Amp: 16	Cable dim.: 2x2.5 mm ² Mount. hole dia.: 18.4 mm Temp.: -40 - +105 °C Connection: Cable	Mount.: Screw Colour: Black Material: Shockproof plastic No./poles: 2 Connection: Cable Male/female: Female ISO norm: 4165 Protection degree: IP 67
181631 USB Adapter Std pkg 1 <i>2 horizontally built-in ports, charging two USB devices simultaneously. USB Charging Kit: HC-CARGO 181602.</i>	Voltage: 12-24 Amp: 2.1		Colour: White/black Material: Polycarbonate
181678 USB Sockets Std pkg 1 <i>Panel: HC-CARGO 181679, 181680, 181681.</i>	Voltage: 12/24 Amp: 2.1		Colour: Black Light: w/ Cap: w/

PLUGS
180113 DIN Plug Std pkg 5 Servicing: HC-CARGO 180115

Universal.

 Material: Plastic
 No./poles: 2
 Male/female: Male
 DIN norm: 72591
 ISO norm: 4165

180230 DIN Plug Std pkg 5

Universal plug suitable for all cigarette lighter sockets. Also suitable for standard DIN socket.

 Voltage: 12/24
 Amp: <8

 Material: Plastic
 No./poles: 2
 Male/female: Male
 ISO norm: 4165

180287 DIN Plug Std pkg 1

Universal plug suitable for all cigarette lighter sockets. Also suitable for standard DIN socket. w/ built-in 8 A fuse.



Voltage: 12/24

 Material: Plastic
 No./poles: 2
 Male/female: Male
 ISO norm: 4165

180399 DIN Plug Std pkg 5 Servicing: HC-CARGO 180315

Universal.



Voltage: 12/24

 Material: Plastic
 No./poles: 2
 Male/female: Male

181629 DIN Plug Std pkg 5 Servicing: HC-CARGO 180315, 181579

Universal.









Voltage: 12/24

 Material: Plastic
 No./poles: 2
 Male/female: Male

ACCESSORIES
171518 Coiled Cable Std pkg 1 Servicing: HC-CARGO 170292, 170387, 170405, 170788, 170406, 170562, 170789, 170537, 171576, 170419, 170460

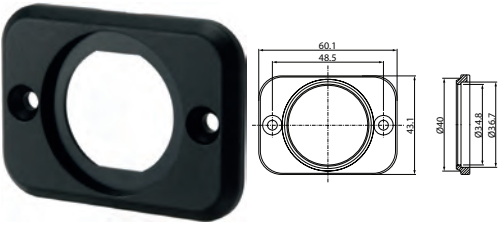
Working length: 2 m

 Plug type: Cigar plug
 Plug 1: 2
 ISO norm: 4165

		EL. SPECIFICATIONS	DIMENSIONS	ADDITIONAL SPECIFICATIONS
171562	Coiled Cable	Std pkg 1 Servicing: HC-CARGO 171494, 171495		
			Working length: 3 m	Plug type: Cigar plug
181602	USB Charging Kit	Std pkg 1 Servicing: HC-CARGO 181601, 181550, 181631		
				Material: PVC
<i>Plug 1: Nokia N70/628/6300/N95. Plug 2: Sony PSP. Plug 3: I-Phone. Plug 4: Nokia 8600/6500C. Plug 5: Nintendo DS Lite. Plug 6: Motorola, Android. Plug 7: Samsung Trace/E900.</i>				
181679	Panel	Std pkg 1 Servicing: HC-CARGO 181678, 161714, 161715, 161716, 161717, 181687		
1 hole.				
				Colour: Black
181680	Panel	Std pkg 1 Servicing: HC-CARGO 181678, 161714, 161715, 161716, 161717		
2 holes.				
				Colour: Black
181681	Panel	Std pkg 1 Servicing: HC-CARGO 181678, 161717		
2 holes.				
			Mount. hole size: 4.3 mm	Colour: Black Material: Plastic
ADAPTERS - 12/24 V				
7-7 PIN				
180201	Trailer Adapter	Std pkg 1		
		Voltage: 24/12		Plug type: 24N, 12N Plug 1: 7 Plug 2: 7 ISO norm: 1724 ISO norm 2: 1185

ADAPTERS 12 V			
2-2 PIN			
181622 Splitter Cable Std pkg 1 Servicing: HC-CARGO 181617			
	Voltage: 12	Cable dim.: 2x1 mm ² Length: 0.25 m	Plug 1: 2 Plug 2: 2
7-7 PIN			
172213 LED Trailer Adapter Std pkg 1			
<i>With built-in resistor.</i>			
	Voltage: 12		Plug type: 12N, 12N Plug 1: 7 Plug 2: 7 ISO norm: 11452-5 ISO norm 2: 11452-2 ISO norm 3: 7637
7-8 PIN			
181618 Trailer Adapter Std pkg 1 Servicing: HC-CARGO 181617			
	Voltage: 12	Cable dim.: 6x1 mm ² Length: 8.5 m	Plug type: 12N, Bayonet Colour: Black Material: ABS plastic Plug 1: 7 Plug 2: 8 ISO norm: 1724
181619 Trailer Adapter Std pkg 1 Servicing: HC-CARGO 181617			
	Voltage: 12	Cable dim.: 6x1 mm ² Length: 11 m	Plug type: 12N, Bayonet Colour: Black Material: ABS plastic Plug 1: 7 Plug 2: 8 ISO norm: 1724
181620 Trailer Adapter Std pkg 1 Servicing: HC-CARGO 181617			
	Voltage: 12	Cable dim.: 6x1 mm ² Length: 14 m	Plug type: 12N, Bayonet Colour: Black Material: ABS plastic Plug 1: 7 Plug 2: 8 ISO norm: 1724
181621 Trailer Adapter 7P/12V Std pkg 1 Servicing: HC-CARGO 181617			
	Voltage: 12	Cable dim.: 4x1 mm ² Length: 2 m	Plug type: 12N, 4 pin Power Seal Colour: Black Material: ABS plastic Plug 1: 7 Plug 2: 4 ISO norm: 1724

7-13 PIN
180221 Trailer Adapter Std pkg 1

Voltage: 12

Cable length: 1 mm

 Plug 1: 7
 Plug 2: 13
 Cable: w/
 ISO norm: 11446
 ISO norm 2: 1724

180373 Trailer Adapter Std pkg 1

Voltage: 12

Cable length: 0.1 mm

 Plug 1: 7
 Plug 2: 13
 Cable: w/
 ISO norm: 11446
 ISO norm 2: 1724

181273 Trailer Adapter Std pkg 1

Extremely compact.

Voltage: 12

 Plug 1: 7
 Plug 2: 13
 ISO norm: 1724
 ISO norm 2: 11446

181461 Trailer Adapter Std pkg 1 Servicing: Hobby and Hymer caravans - Visit our web catalogue for further information

Connect pos. 2/54 on 7-pin to pos. 9 and 10 on 13-pin. (continuous power supply) and connect 3/31 on 7-pin to pos. 3.11 and 13 on 13-pin.

Voltage: 12

 Plug 1: 7
 Plug 2: 13
 ISO norm: 1724
 ISO norm 2: 11446

181677 Trailer Adapter Std pkg 1

Voltage: 12

 Plug 1: 7
 Plug 2: 13
 ISO norm: 1724
 ISO norm 2: 11446

13-7 PIN
180213 Trailer Adapter Std pkg 1

Voltage: 12

Cable length: 0.8 mm

 Plug 1: 13
 Plug 2: 7
 Cable: w/
 ISO norm: 11446
 ISO norm 2: 1724

180298 Trailer Adapter Std pkg 1

Voltage: 12

 Plug 1: 13
 Plug 2: 7
 Cable: w/
 ISO norm: 11446
 ISO norm 2: 1724

		EL. SPECIFICATIONS	DIMENSIONS	ADDITIONAL SPECIFICATIONS
180305 Trailer Adapter Std pkg 1				
		Voltage: 12		Plug 1: 13 Plug 2: 7 ISO norm: 11446 ISO norm 2: 1724
180332 Trailer Adapter Std pkg 1				
		Voltage: 12		Plug type: Multicon Plug 1: 13 Plug 2: 7-13 ISO norm: 11446 ISO norm 2: 1724
180574 Trailer Adapter Std pkg 1				
		Voltage: 12	Cable length: 0.3 mm	Plug type: 12N/12S Plug 1: 13 Plug 2: 7 Cable: w/ ISO norm: 11446 ISO norm 2: 1724
180606 Trailer Adapter Std pkg 1				
<i>Extremely compact.</i>				
		Voltage: 12		Plug 1: 13 Plug 2: 7 ISO norm: 11446 ISO norm 2: 1724
181669 UK short adapter Std pkg 1 Servicing: UK - Visit our web catalogue for further information				
		Voltage: 12		Plug 1: 13 Plug 2: 2x7 Cable: w/o ISO norm: 11446 ISO norm 2: 1724 ISO norm 3: 3732
15-7 PIN				
180327 Trailer Adapter Std pkg 1				
<i>w/ 42 windings.</i>				
		Voltage: 24	Cable dim.: 6x1+1x2.5 mm ² Cable length: 3.5 mm	Plug type: 24N/24S, Europe Colour: Black Material: Polyurethan Plug 1: 15 Plug 2: 2x7 Cable: w/ ISO norm: 12098 ISO norm 2: 1185 ISO norm 3: 3731
180622 Trailer Adapter Std pkg 1				
		Voltage: 24		Plug type: 24N/24S Plug 1: 15 Plug 2: 7 ISO norm: 12098 ISO norm 2: 1185 ISO norm 3: 3721

DISTRIBUTOR BOX

181617 Distribution Box Std pkg 1

Trailer Adapter: HC-CARGO 181618, 181619, 181620. Socket w/ cable: HC-CARGO 181621. Splitter Cable: HC-CARGO 181622. Cable w/ connector: HC-CARGO 181623, 181624, 181625, 181626. Bayonet connector: HC-CARGO 181627.



Dim.: 160x60x120 mm
Input: 8 pin
Outlet: 6x4 pin + 2x3 pin

Protection degree: IP 54

TRAILER SOCKETS - 12 V

3 PIN

180306 Socket Std pkg 1



Voltage: 12
Amp: 5/25/25

Connection: Terminal

Colour: Black
Material: Plastic
No./poles: 3
Connection: Terminal
Male/female: Female

180307 Socket Std pkg 1 Servicing: HC-CARGO 180308



Voltage: 12
Amp: 5/25/25

Connection: Terminal

Colour: Black
Material: Plastic
No./poles: 3
Connection: Terminal
Male/female: Female
DIN norm: 9680

7 PIN

180110 Trailer Socket Std pkg 5 Servicing: HC-CARGO 180107, 180108, 180147, 181547

Rubber Gasket: HC-CARGO 180249. Mounting Bracket: HC-CARGO 181583.



Voltage: 12

Connection: Screw

Plug type: 12N
Colour: Black
Material: Shock thermo plastic
No./poles: 7
Connection: Screw
Male/female: Female
DIN norm: 72577
ISO norm: 1724

180150 Coupling Socket Std pkg 1 Servicing: HC-CARGO 180107, 180108, 180147, 181547



Voltage: 12

Connection: Screw

Plug type: 12N
Colour: Black
Material: Shock thermo plastic
No./poles: 7
Connection: Screw
Male/female: Female
DIN norm: 72579
ISO norm: 1724

180218 Trailer Socket Std pkg 5 Servicing: HC-CARGO 180107, 180108, 180147, 181547

Rubber Gasket: HC-CARGO 180249, 181612, 181628. Mounting Bracket: HC-CARGO 181583.



Voltage: 12

Connection: Screw

Plug type: 12N
Colour: Aluminium
Material: Cast aluminum
No./poles: 7
Connection: Screw
Male/female: Female
DIN norm: 72577
ISO norm: 1724

EL. SPECIFICATIONS		DIMENSIONS	ADDITIONAL SPECIFICATIONS
180239 Trailer Socket Std pkg 5 Servicing: HC-CARGO 180238 w/ changed central contact 7/58L. w/ grey cap. Rubber Gasket: HC-CARGO 180249. Mounting Bracket: HC-CARGO 181583.			
 	Voltage: 12	Connection: Screw	Plug type: 12S Colour: Black/white Material: Shock thermo plastic No./poles: 7 Connection: Screw Male/female: Female ISO norm: 3732
180293 Trailer Socket Std pkg 5 Servicing: HC-CARGO 180107, 180108, 180147, 181547 Rubber Gasket: HC-CARGO 180249. Mounting Bracket: HC-CARGO 181583.			
 	Voltage: 12	Connection: Terminal	Plug type: 12N Colour: Black Material: Shock thermo plastic No./poles: 7 Connection: Terminal Male/female: Female DIN norm: 72577 ISO norm: 1724
180620 Coupling Socket Std pkg 1 w/ changed 7/58L contact.			
 	Voltage: 12	Connection: Cable	Plug type: 12S Colour: Grey Material: Shock thermo plastic No./poles: 7 Connection: Cable Male/female: Female
181485 Trailer Socket Std pkg 5 Servicing: HC-CARGO 180107, 180108, 180147, 181547 w/ rear fog light cut-off. Rubber Gasket: HC-CARGO 181612, 181628. Mounting Bracket: HC-CARGO 181583.			
 	Voltage: 12	Connection: Screw	Plug type: 12N Colour: Black Material: Shock thermo plastic No./poles: 7 Connection: Screw Male/female: Female DIN norm: 72577 ISO norm: 1724
181604 Trailer Socket Std pkg 1 Servicing: HC-CARGO 180107, 180108, 180147, 181547 Micro and mechanical switch.			
 	Voltage: 12 Amp: 6	Connection: Screw	Plug type: 12N Colour: Black Material: Shock thermo plastic No./poles: 7 Connection: Screw Male/female: Female DIN norm: 72577 ISO norm: 1724
13 PIN			
180214 Trailer Socket Std pkg 1 Servicing: HC-CARGO 180212 Trailer socket kit: HC-CARGO 180405. Rubber Gasket: HC-CARGO 181582, 181510.			
 	Voltage: 12	Connection: Screw	Colour: Black Locking device: Bayonet Material: Nickel plated brass No./poles: 13 Connection: Screw Gasket: Yes Male/female: Female DIN norm: 72570 ISO norm: 11446 Protection degree: Splash proof

EL. SPECIFICATIONS		DIMENSIONS	ADDITIONAL SPECIFICATIONS
181274 Trailer Socket Std pkg 1 Servicing: HC-CARGO 180212 <i>w/ micro switch, that switch over the rear fog lamps from car to trailer. Trailer socket kit: HC-CARGO 180405. Rubber Gasket: HC-CARGO 181582.</i>			
 	Voltage: 12	Connection: Screw	Colour: Black Locking device: Bayonet Material: Nickel plated brass No./poles: 13 Connection: Screw Male/female: Female DIN norm: 72570 ISO norm: 11446 Protection degree: Splash proof
181576 Coupling Socket Std pkg 1			
 	Voltage: 12	Connection: Screw	Colour: Black Material: Shockproof plastic No./poles: 13 Connection: Screw Male/female: Female ISO norm: 11446
181692 Trailer Plug Std pkg 1			
 	Voltage: 12	Connection: Screw	Socket: 7-13 Colour: Black No./poles: 13 Connection: Screw
13-7 PIN			
180329 Trailer Socket Std pkg 1 Servicing: HC-CARGO 180330 <i>w/ micro switch, that switch over the rear fog lamps from car to trailer.</i>			
	Voltage: 12	Connection: Screw	Plug type: Multicon Colour: Black Material: Shock thermo plastic No./poles: 7/13 Connection: Screw Male/female: Female ISO norm: 1724
SPARE PARTS			
180249 Rubber Gasket Std pkg 10 Servicing: HC-CARGO 180110, 180218, 180239, 180293, 181485			
 			
181510 Rubber Gasket Std pkg 10 Servicing: HC-CARGO 180214, 181485			
 			
181582 Rubber Gasket Std pkg 1 Servicing: HC-CARGO 180214, 181274 <i>w/ 90° cable bulge.</i>			
 			Material: Plastics

		EL. SPECIFICATIONS	DIMENSIONS	ADDITIONAL SPECIFICATIONS
181612 Rubber Gasket Std pkg 10 Servicing: HC-CARGO 180110, 180218, 180239, 180293, 181485				
				Colour: Black Material: EPDM rubber
181628 Rubber Gasket Std pkg 5 Servicing: HC-CARGO 180110, 180218, 180239, 180293, 181485				
				Colour: Black Material: EPDM rubber
TRAILER SOCKETS - 24 V				
3 PIN				
180402 Trailer Socket Std pkg 1				
		Voltage: 6/24	Connection: Screw	Colour: Black Material: Shock thermo plastic No./poles: 3 Connection: Screw Male/female: Female
5 PIN				
180243 ABS Socket Std pkg 1				
<i>w/ ejector device for correct plug/socket connection. Incl. pins 3x1.5+2x4 mm². Terminal: HC-CARGO 191171, 191172, 191196, 191197.</i>				
		Voltage: 24		Plug type: ABS No./poles: 5 Male/female: Female DIN norm: 74001 ISO norm: 7638 Alternativ no.: 181467
181467 ABS Socket Std pkg 1				
<i>Screw connection w/ wirecolour indication.</i>				
		Voltage: 24		Plug type: ABS Locking device: Metal bracket No./poles: 5 Male/female: Female ISO norm: 7638 Alternativ no.: 180243
7 PIN				
180112 Trailer Socket Std pkg 1 Servicing: HC-CARGO 180111, 180154				
<i>Terminal Coupling: HC-CARGO 180611.</i>				
		Voltage: 24	Connection: Terminal	Plug type: 24N, Europe Colour: Black Material: Shock thermo plastic No./poles: 7 Connection: Terminal Male/female: Female DIN norm: 72579 ISO norm: 1185

		EL. SPECIFICATIONS	DIMENSIONS	ADDITIONAL SPECIFICATIONS
180153 Trailer Socket Std pkg 1 Servicing: HC-CARGO 180111, 180154				
Terminal Cover: HC-CARGO 180105, 180106.				
		Voltage: 24	Connection: Screw	Plug type: 24N, Europe Colour: Black Material: Shock thermo plastic No./poles: 7 Connection: Screw Male/female: Female DIN norm: 72579 ISO norm: 1185
180219 Trailer Socket Std pkg 1 Servicing: HC-CARGO 180111, 180154				
Terminal Cover: HC-CARGO 180105, 180106.				
		Voltage: 24	Connection: Screw	Plug type: 24N, Europe Material: Cast aluminum No./poles: 7 Connection: Screw Male/female: Female DIN norm: 72579 ISO norm: 1185
180240 Trailer Socket Std pkg 1 Servicing: HC-CARGO 180610, 180624				
w/ changed 1/31 contact. w/ grey cap. Terminal Cover: HC-CARGO 180105, 180106.				
		Voltage: 24	Connection: Screw	Plug type: 24S, Europe Colour: Black Material: Shock thermo plastic No./poles: 7 Connection: Screw Male/female: Female ISO norm: 3731
180296 Trailer Socket Std pkg 1 Servicing: HC-CARGO 180297				
Terminal Coupling: HC-CARGO 180612. Terminal Cover: HC-CARGO 180105, 180106.				
		Voltage: 24	Connection: Terminal	Plug type: 24N, Europe Material: Cast aluminum No./poles: 7 Connection: Terminal Male/female: Female DIN norm: 72579 ISO norm: 1185
180351 Trailer Socket Std pkg 1 Servicing: HC-CARGO 180297				
16x flat tongue. Terminal Coupling: HC-CARGO 180612. Terminal Cover: HC-CARGO 180105, 180106.				
		Voltage: 24	Connection: Terminal	Plug type: 24N, Europe Material: Cast aluminum No./poles: 7 Connection: Terminal Male/female: Female DIN norm: 72579 ISO norm: 1185
180568 Trailer Socket Std pkg 1 Servicing: HC-CARGO 180241				
w/ changed 1/31 contact. w/ grey cap. Terminal Coupling: HC-CARGO 180612. Terminal Cover: HC-CARGO 180105, 180106.				
		Voltage: 24	Connection: Terminal	Plug type: 24S, Europe Colour: Black Material: Shock thermo plastic No./poles: 7 Connection: Terminal Male/female: Female ISO norm: 3731
180569 Trailer Socket Std pkg 1 Servicing: HC-CARGO 180610, 180624				
w/ changed 1/31 contact. w/ grey cap. Terminal Coupling: HC-CARGO 180611. Terminal Cover: HC-CARGO 180105, 180106.				
		Voltage: 24	Connection: Terminal	Plug type: 24S, Europe Material: Cast aluminum No./poles: 7 Connection: Terminal Male/female: Female ISO norm: 3731

180571 EBS Socket		Std pkg 1			
w/ ejector device for correct plug/socket connection. Incl. pins 3x1.5+2x4 mm ² . Terminal: HC-CARGO 191171, 191172, 191196, 191197.					
	Voltage: 24	Connection: Terminal	Plug type: EBS No./poles: 7 Connection: Terminal Male/female: Female DIN norm: 74001 ISO norm: 7638 Alternativ no.: 181470		
180607 Trailer Socket		Std pkg 1	Servicing: HC-CARGO 180111, 180154		
Terminal Coupling: HC-CARGO 180611.					
	Voltage: 24	Connection: Terminal	Plug type: 24N, Europe No./poles: 7 Connection: Terminal Male/female: Female DIN norm: 72579 ISO norm: 1185 Protection degree: IP 54 ADR-approved: Yes		
180608 Trailer Socket		Std pkg 1	Servicing: HC-CARGO 180610, 180624		
w/ changed 1/31 contact. w/ grey cap. Terminal Coupling: HC-CARGO 180611.					
	Voltage: 24	Connection: Terminal	Plug type: 24S, Europe Colour: Black Material: Shock thermo plastic No./poles: 7 Connection: Terminal Male/female: Female ISO norm: 3731 Protection degree: IP 54 ADR-approved: Yes		
181470 EBS Socket		Std pkg 1			
Screw connection w/ wirecolour indication.					
	Voltage: 24			Plug type: EBS Locking device: Metal bracket No./poles: 7 Male/female: Female ISO norm: 7638 Alternativ no.: 180571	
181471 EBS Socket		Std pkg 1			
Screw connection w/wire colour indication. Angled.					
	Voltage: 24			Plug type: EBS Locking device: Bayonet No./poles: 7 ISO norm: 7638	
13 PIN					
180253 EBS Socket		Std pkg 1			
Incl. pins 12x1+1x2.5 mm ² . Weather proof. Terminal: HC-CARGO 191171, 191172, 191196, 191197.					
	Voltage: 24			Plug type: EBS No./poles: 13 Male/female: Female DIN norm: 74001 ISO norm: 12098 ADR-approved: Yes GGVS approval: Yes	

14 PIN
180352 Trailer Socket Std pkg 1 Servicing: HC-CARGO 180353

 For max. 6 mm² cable. Socket and plug can be disconnected automatically.

Voltage: 24

 Colour: Black
 Material: Shock thermo plastic
 No./poles: 14
 Male/female: Female

15 PIN
180286 EBS Socket Std pkg 1

 w/ locking device preventing accidental disengagement. Incl. terminals 10x1.5+2x1+3x2.5 mm². Terminal: HC-CARGO 191171, 191172, 191196, 191197.

Voltage: 24

 Plug type: EBS
 No./poles: 15
 Male/female: Female
 DIN norm: 72570
 ISO norm: 12098
 ADR-approved: Yes
 GGVS approval: Yes
 Alternativ no.: 181473

181473 EBS Socket Std pkg 1

Voltage: 24

Connection: Screw

 Locking device: Metal bracket
 No./poles: 15
 Connection: Screw
 Male/female: Female
 DIN norm: 72570
 ISO norm: 12098
 Protection degree: Waterproof
 ADR-approved: Yes
 GGVS approval: Yes
 Alternativ no.: 180286

181474 EBS Socket Std pkg 1

Voltage: 24

Connection: Screw

 Locking device: Bayonet
 No./poles: 15
 Connection: Screw
 Male/female: Female
 DIN norm: 72570
 ISO norm: 12098
 Protection degree: Waterproof
 ADR-approved: Yes
 GGVS approval: Yes

TRAILER SOCKETS - 6/24 V
4 PIN
180404 Trailer Socket Std pkg 1

Voltage: 6-24

Connection: Screw

 Colour: Black
 Material: Shock thermo plastic
 No./poles: 4
 Connection: Screw
 Male/female: Female
 DIN norm: 72575

TRAILER PLUGS - 12 V
3 PIN
180308 Plug Std pkg 1 Servicing: HC-CARGO 180307

 Voltage: 12
 Amp: 5/25/25

Connection: Terminal

 Colour: Black
 Material: Plastic
 No./poles: 3
 Connection: Terminal
 Male/female: Male
 DIN norm: 9680

7 PIN			
180107 Trailer Plug Std pkg 5 Servicing: HC-CARGO 180110, 180218, 180293, 181485, 181604			
Coupling Socket: HC-CARGO 180150.			
 	Voltage: 12	Connection: Screw	Plug type: 12N Material: Cast aluminum No./poles: 7 Connection: Screw Male/female: Male DIN norm: 72577 ISO norm: 1724
180108 Trailer Plug Std pkg 5 Servicing: HC-CARGO 180110, 180218, 180293, 181485, 181604			
Coupling Socket: HC-CARGO 180150.			
 	Voltage: 12	Connection: Screw	Plug type: 12N Colour: Black Material: Shock thermo plastic No./poles: 7 Connection: Screw Male/female: Male DIN norm: 72577 ISO norm: 1724
180147 Trailer Plug Std pkg 5 Servicing: HC-CARGO 180110, 180218, 180293, 181485, 181604			
Coupling Socket: HC-CARGO 180150.			
 	Voltage: 12	Connection: Screw	Plug type: 12N Mount.: Snap-on Colour: Black Material: Shock thermo plastic w/ snap-on session No./poles: 7 Connection: Screw Male/female: Male DIN norm: 72577 ISO norm: 1724
180238 Trailer Plug Std pkg 5 Servicing: HC-CARGO 180239			
w/ changed 7/58L contact.			
 	Voltage: 12	Connection: Screw	Plug type: 12S Colour: Grey Material: Shock thermo plastic No./poles: 7 Connection: Screw Male/female: Male ISO norm: 3732
181547 Trailer Plug Std pkg 5 Servicing: HC-CARGO 180110, 180218, 180293, 181485, 181604			
w/ rubber grommet for 1 cable. Grommet for 2 cables: HC-CARGO 181581. Coupling Socket: HC-CARGO 180150.			
 	Voltage: 12	Connection: Terminal	Plug type: 12N Colour: Black Material: Plastic No./poles: 7 Connection: Terminal Male/female: Male DIN norm: 72577 ISO norm: 1724
13 PIN			
180212 Trailer Plug Std pkg 1 Servicing: HC-CARGO 180214, 181274			
Nickel plated brass pins.			
 	Voltage: 12	Connection: Screw	Colour: Black Locking device: Bayonet Material: Shock thermo plastic No./poles: 13 Connection: Screw Male/female: Male DIN norm: 72570 ISO norm: 11446 Protection degree: Splash proof

13-7 PIN
180330 Trailer Plug Std pkg 1 Servicing: HC-CARGO 180329

+ 6 contacts.



Voltage: 12

Connection: Screw

 Plug type: Multicon
 Colour: Black
 Material: Shock thermo plastic
 No./poles: 7/13
 Connection: Screw
 Male/female: Male
 ISO norm: 1724

181675 Trailer Coil Std pkg 1

Voltage: 12

 Cable dim.:
 6x1+1x1.5 mm²
 Working length: 1.5 m

 Plug type: 12N
 Colour: Black
 Material: Polyurethan
 Windings: 15
 Plug 1: 7
 Plug 2: 13
 ISO norm: 1724
 ISO norm 2: 11446

TRAILER PLUGS - 24 V
5 PIN
180242 ABS Plug Std pkg 1

 Incl. tubes 3x1.5+2x4 mm² (HC-CARGO 191170). Terminal: HC-CARGO 191168, 192180, 191169, 192181.

Voltage: 24

Connection: Terminal

 Plug type: ABS
 Locking device: Metal bracket
 No./poles: 5
 Connection: Terminal
 Male/female: Male
 ISO norm: 7638
 Alternativ no.: 181466

181466 ABS Plug Std pkg 1

Screw connection w/ wirecolour indication.



Voltage: 24

Connection: Terminal

 Plug type: ABS
 Locking device: Metal bracket
 No./poles: 5
 Connection: Terminal
 Male/female: Male
 ISO norm: 7638
 Alternativ no.: 180242

7 PIN
180111 Trailer Plug Std pkg 1 Servicing: HC-CARGO 180112, 180153, 180219, 180607

Terminal Coupling: HC-CARGO 180612.



Voltage: 24

Connection: Terminal



 Plug type: 24N, Europe
 Colour: Black
 Material: Shock thermo plastic
 No./poles: 7
 Connection: Terminal
 Male/female: Male
 DIN norm: 72579
 ISO norm: 1185

180154 Trailer Plug Std pkg 1 Servicing: HC-CARGO 180112, 180153, 180219, 180607

Voltage: 24

Connection: Screw

 Plug type: 24N, Europe
 Colour: Black
 Material: Shock thermo plastic
 No./poles: 7
 Connection: Screw
 Male/female: Male
 DIN norm: 72579
 ISO norm: 1185

		EL. SPECIFICATIONS	DIMENSIONS	ADDITIONAL SPECIFICATIONS
180220 Trailer Plug Std pkg 1  		Voltage: 24	Connection: Screw	Plug type: 24N, Europe Material: Cast aluminum No./poles: 7 Connection: Screw Male/female: Male DIN norm: 72579 ISO norm: 1185
180241 Trailer Plug Std pkg 1 Servicing: HC-CARGO 180568 <i>w/ changed 1/31 contact. w/ grey plastic interior. Terminal Coupling: HC-CARGO 180611.</i>		Voltage: 24	Connection: Screw	Plug type: 24S, Europe Colour: Black Material: Shock thermo plastic No./poles: 7 Connection: Screw Male/female: Male ISO norm: 3731
180297 Trailer Plug Std pkg 1 Servicing: HC-CARGO 180351, 180296 <i>Terminal Coupling: HC-CARGO 180611.</i>		Voltage: 24	Connection: Terminal	Plug type: 24N, Europe Material: Cast aluminum No./poles: 7 Connection: Terminal Male/female: Male DIN norm: 72579 ISO norm: 1185
180570 EBS Plug Std pkg 1 <i>Incl. pins 5x1.5+2x4 mm². w/ locking device. Terminal: HC-CARGO 191168, 192180, 191169, 192181.</i>		Voltage: 24	Connection: Terminal	Plug type: EBS Locking device: Metal bracket No./poles: 7 Connection: Terminal Male/female: Male DIN norm: 40050 ISO norm: 7638 Protection degree: Waterproof Alternativ no.: 181469
180610 Trailer Plug Std pkg 1 Servicing: HC-CARGO 180240, 180569, 180608 <i>w/ changed 1/31 contact. w/ grey plastic interior.</i>		Voltage: 24	Connection: Screw	Plug type: 24S, Europe Colour: Black Material: Shock thermo plastic No./poles: 7 Connection: Screw Male/female: Male ISO norm: 3731 Protection degree: IP 54 ADR-approved: Yes
180624 Trailer Plug Std pkg 1 Servicing: HC-CARGO 180240, 180569, 180608 <i>w/ changed 1/31 contact. w/ grey plastic interior.</i>		Voltage: 24	Connection: Screw	Plug type: 24S, Europe Material: Cast aluminum No./poles: 7 Connection: Screw Male/female: Male ISO norm: 3731
181469 EBS Plug Std pkg 1 <i>Screw connection w/ wirecolour indication.</i>		Voltage: 24	Connection: Terminal	Plug type: EBS Locking device: Metal bracket No./poles: 7 Connection: Terminal Male/female: Male ISO norm: 7638 Protection degree: Waterproof Alternativ no.: 180570

13 PIN
180252 EBS Plug Std pkg 1

Incl. pins 12x1+1x2.5 mm². Weather proof. Terminal: HC-CARGO 191168, 192180, 191169, 192181.

Voltage: 24

Connection: Terminal

 Plug type: EBS
 No./poles: 13
 Connection: Terminal
 Male/female: Male
 DIN norm: 40050
 ISO norm: 7638
 ADR-approved: Yes
 GGVS approval: Yes

14 PIN
180353 Trailer Plug Std pkg 1 Servicing: HC-CARGO 180352

For max. 6 mm² cable. Socket and plug can be disconnected automatically.

Voltage: 24

 Colour: Black
 Material: Shock thermo plastic
 No./poles: 14
 Male/female: Male

15 PIN
180285 EBS Plug Std pkg 1

Incl. pins 12x1.5+3x2.5 mm². Terminal: HC-CARGO 191168, 192180.

Voltage: 24

Connection: Terminal

 Plug type: EBS
 No./poles: 15
 Connection: Terminal
 Male/female: Male
 DIN norm: 72570
 ISO norm: 12098
 ADR-approved: Yes
 GGVS approval: Yes
 Alternativ no.: 181472

181472 EBS Plug Std pkg 1

Voltage: 24

Connection: Screw

 Locking device: Metal bracket
 No./poles: 15
 Connection: Screw
 Male/female: Male
 DIN norm: 72570
 ISO norm: 12098
 Protection degree: Waterproof
 GGVS approval: Yes
 Alternativ no.: 180285

TRAILER PLUGS - 6/24 V
3 PIN
180401 Plug Std pkg 1

 Voltage: 6-24
 Amp: max. 20

Connection: Screw

 Colour: Black
 Material: Shock thermo plastic
 No./poles: 3
 Connection: Screw
 Male/female: Male
 DIN norm: 9680

4 PIN
180403 Plug Std pkg 1

Voltage: 6-24

Connection: Screw

 Colour: Black
 Material: Shock thermo plastic
 No./poles: 4
 Connection: Screw
 Male/female: Male
 DIN norm: 72575

ISOBUS			
181688	Master Socket	Std pkg 1	
		Voltage: 12	Plug type: 9P/12V, ISOBUS Colour: Black Locking device: Metal bracket No./poles: 9 Male/female: Female ISO norm: 11783-2
181689	Slave socket	Std pkg 1	
		Voltage: 12	Plug type: 9P/12V, ISOBUS Colour: Black Locking device: Metal bracket No./poles: 9 Male/female: Female ISO norm: 11783-2
181690	Plug	Std pkg 1	
		Voltage: 12	Plug type: 9P/12V, ISOBUS Colour: Black No./poles: 9 Male/female: Male ISO norm: 11783-2
181691	Plug	Std pkg 1	
		Voltage: 12	Plug type: Male, ISOBUS Colour: Black No./poles: 4 Male/female: Male ISO norm: 11783-2
CABLE KITS 12 V			
7 PIN			
180001	Trailer Cable Kit	Std pkg 1	
		Voltage: 12	Length: 1.4 m Cable type: Single core w/ flex Socket type: 12N Fixing materials: Yes No./poles: 7 Gasket: Yes DIN norm: 72577 ISO norm: 1724
180144	Trailer Cable Kit	Std pkg 1	
		Voltage: 12	Length: 1.4 m Cable type: Multi core Socket type: 12N Fixing materials: Yes No./poles: 7 Gasket: Yes Male/female: Male DIN norm: 72577 ISO norm: 1724
180248	Trailer Cable Kit	Std pkg 1	
		Voltage: 12	Length: 2 m Cable type: Multi core Socket type: 12N Fixing materials: Yes No./poles: 7 Gasket: Yes Male/female: Male DIN norm: 72577 ISO norm: 1724

13 PIN
180405 Trailer Cable Kit Std pkg 1 Servicing: HC-CARGO 180214, 181274

w/ rubber gasket.

Voltage: 12

Length: 1.8 m

 Cable type: Multi core
 Fixing materials: Yes
 No./poles: 13
 Gasket: Yes
 DIN norm: 72570
 ISO norm: 4091

TRAILER COILS 12 V
7 PIN
180225 Trailer Coil Std pkg 1

Voltage: 12

 Cable dim.:
 6x1+1x1.5 mm²
 Working length: 3.5 m

 Plug type: 12N, 24N, Europe
 Colour: Black
 Material: Polyurethan
 Windings: 42
 Plug 1: 7
 Plug 2: 7
 ISO norm: 1724

180372 Trailer Coil Std pkg 1

Voltage: 12

 Cable dim.:
 6x1+1x1.5 mm²
 Working length: 3.5 m

 Plug type: 12N, 12N
 Colour: Black
 Material: Polyurethan
 Windings: 42
 Plug 1: 7
 Plug 2: 7
 ISO norm: 1724

180613 Trailer Coil Std pkg 1

Voltage: 12

 Cable dim.:
 6x1+1x1.5 mm²
 Working length: 1.5 m

 Plug type: 12N, 12N
 Colour: Black
 Material: Polyurethan
 Windings: 15
 Plug 1: 7
 Plug 2: 7
 ISO norm: 1724

181544 Extension Cable Coil Std pkg 1

Voltage: 12

 Cable dim.:
 6x1.5+1x2 mm²
 Working length: 3.5 m

 Plug type: 12N, Europe, 12N, Europe
 Mount.: Screw
 Colour: Black
 Material: Shock thermo plastic
 Windings: 42
 Plug 1: 7
 Plug 2: 7
 DIN norm: 72577
 ISO norm: 1724

13 PIN
181600 Trailer coil Std pkg 1

Max extension length: 4.5 m.



Voltage: 12

Working length: 3 m

 Colour: Black
 Windings: 17
 Plug 1: 13
 Plug 2: 13
 ISO norm: 11446

TRAILER COILS 24 V			
2 PIN			
181489	Trailer Coil	Std pkg 1	
		Voltage: 24	Cable dim.: 2x35 mm ² Working length: 4 m
			Plug type: Nato plug, Nato plug Colour: Red/black Material: Polyurethan Windings: 35 Plug 1: 2 Plug 2: 2
5 PIN			
180247	ABS Trailer Coil	Std pkg 1	
		Voltage: 24	Cable dim.: 2x4+3x1.5 mm ² Working length: 4 m
			Plug type: ABS, ABS Material: Polyurethan Plug 1: 5 Plug 2: 5 DIN norm: 74001 ISO norm: 7638
7 PIN			
180194	Trailer Coil	Std pkg 1	
		Voltage: 24	Cable dim.: 6x1+1x1.5 mm ² Working length: 3.5 m
			Plug type: 12N, 24N, Europe Colour: Black Material: Nylon Windings: 20 Plug 1: 7 Plug 2: 7 ISO norm: 1185 ISO norm 2: 1724
180195	Trailer Coil	Std pkg 1	
Aluminium plug.			
		Voltage: 24	Cable dim.: 6x1+1x1.5 mm ² Working length: 3.5 m
			Plug type: 24N, Europe, 24N, Europe Colour: Black Material: Nylon Windings: 20 Plug 1: 7 Plug 2: 7 DIN norm: 72579 ISO norm: 1185
180196	Trailer Coil	Std pkg 1	
		Voltage: 24	Cable dim.: 6x1+1x1.5 mm ² Working length: 3.5 m
			Plug type: 24N, Europe, 24N, Europe Colour: Black Material: Nylon Windings: 20 Plug 1: 7 Plug 2: 7 DIN norm: 72579 ISO norm: 1185
180226	Trailer Coil	Std pkg 1	
		Voltage: 24	Cable dim.: 6x1+1x1.5 mm ² Working length: 3.5 m
			Plug type: 24N, Europe, 24N, Europe Colour: Black Material: Polyurethan Windings: 42 Plug 1: 7 Plug 2: 7 ISO norm: 1185
180227	Trailer Coil	Std pkg 1	
Aluminium plug.			
		Voltage: 24	Cable dim.: 6x1+1x1.5 mm ² Working length: 3.5 m
			Plug type: 24N, Europe, 24N, Europe Colour: Black Material: Polyurethan Windings: 42 Plug 1: 7 Plug 2: 7 ISO norm: 1185

		EL. SPECIFICATIONS	DIMENSIONS	ADDITIONAL SPECIFICATIONS
180228 Trailer Coil Std pkg 1				
		Voltage: 24	Cable dim.: 6x1+1x1.5 mm ² Working length: 3.5 m	Plug type: 24N, Europe, 24N, Europe Mount.: Moulded Colour: Black Material: Polyurethan Windings: 42 Plug 1: 7 Plug 2: 7 ISO norm: 1185
180316 Trailer Coil Std pkg 1				
		Voltage: 24	Cable dim.: 6x1+1x1.5 mm ² Working length: 3.5 m	Plug type: 24S, Europe, 24S, Europe Colour: Black Material: Polyurethan Windings: 42 Plug 1: 7 Plug 2: 7 ISO norm: 3731
180572 Trailer Coil Std pkg 1				
		Voltage: 24	Cable dim.: 2x4+5x1.5 mm ² Working length: 4 m	Plug type: EBS, EBS Material: Polyurethan Plug 1: 7 Plug 2: 7 DIN norm: 74001 ISO norm: 7638
15 PIN				
180251 Trailer Coil Std pkg 1				
		Voltage: 24	Cable dim.: 12x1.5+3x2.5 mm ² Working length: 3.5 m	Material: Polyurethan Plug 1: 15 Plug 2: 15 ISO norm: 4141 ISO norm 2: 6772 ISO norm 3: 12098 GGVS approval: Yes
ACCESSORIES				
180611 Terminal Coupling Std pkg 5		Servicing: HC-CARGO 180112, 180569, 180607, 180608, 180241, 180297		
<i>For trailer sockets.</i>				
		Voltage: 24		Plug type: Europe Colour: White No./poles: 7 Male/female: Multiplug
180612 Terminal Coupling Std pkg 5		Servicing: HC-CARGO 180296, 180351, 180568, 180111		
		Voltage: 24		Plug type: Europe Colour: Red No./poles: 7
181581 Rubber Bushing Std pkg 10		Servicing: HC-CARGO 181547		
<i>w/ 2 outlets.</i>				
			OD: 6.5 mm	

		EL. SPECIFICATIONS	DIMENSIONS	ADDITIONAL SPECIFICATIONS
181583	Mounting Bracket	Std pkg 1	Servicing: HC-CARGO 180110, 180218, 180239, 180293, 181485	
<i>For trailer socket.</i>				
			ID: 40 mm OD: 80 mm Dist. mount. holes: 20 mm Mount. hole size: 12 mm	No./mounting holes: 2 (0)
181623	Cable w/ connector	Std pkg 1	Servicing: HC-CARGO 181617	
		Voltage: 12	Cable dim.: 2x1 mm ² Length: 2 m	Plug type: 2 pin Power Seal Plug 1: 2
181624	Cable w/ connector	Std pkg 1	Servicing: HC-CARGO 181617	
		Voltage: 12	Cable dim.: 2x1 mm ² Length: 3.56 m	Plug type: 2 pin Power Seal Plug 1: 2
181625	Cable w/ connector	Std pkg 1	Servicing: HC-CARGO 181617	
		Voltage: 12	Cable dim.: 4x1 mm ² Length: 2.3 m	Plug type: 4 pin Power Seal Plug 1: 4
181626	Cable w/ connector	Std pkg 1	Servicing: HC-CARGO 181617	
		Voltage: 12	Cable dim.: 4X1 mm ² Length: 4.06 m	Plug type: 4 pin Power Seal Plug 1: 4
181627	Bayonet connector	Std pkg 1	Servicing: HC-CARGO 181617	
		Voltage: 12	Cable dim.: 8x1.5-2.5 mm ²	Mount.: Terminal Locking device: Bayonet No./poles: 8 DIN norm: 72580
NATO CABLE CONNECTORS				
180197	Nato Socket	Std pkg 1		
<i>Terminal: HC-CARGO 180560. Nato Plug: HC-CARGO 181563, 181611. Rubber Gasket: HC-CARGO 181671.</i>				
		Voltage: 24 Amp: 200	Dim.: 35-50 mm ² Dist. mount. holes: 82.5/47.6 mm Connection: Solder/crimp	No./mounting holes: 4 No./poles: 2 Connection: Solder/crimp Male/female: Female Approval: VG 96917

180198 Nato Plug		Std pkg 1	Servicing: HC-CARGO 193002	
<i>Terminal: HC-CARGO 181670.</i>				
	Voltage: 24 Amp: 200	Dim.: 50 mm ² Connection: Solder/ crimp	Material: Aluminium No./poles: 2 Connection: Solder/crimp Male/female: Male Approval: VG 96917	
180325 Nato Plug		Std pkg 1		
<i>w/ screw device. Terminal: HC-CARGO 181670.</i>				
	Voltage: 24 Amp: 200	Dim.: 50 mm ² Connection: Solder/ crimp	Material: Metal/Rubber No./poles: 2 Connection: Solder/crimp Male/female: Male Alternativ no.: 181563	
180349 Nato Socket		Std pkg 1		
	Voltage: 24 Amp: 250	Dim.: 70 mm ² Dist. mount. holes: 85/60 mm Connection: 10 mm ring terminals	No./mounting holes: 4 No./poles: 2 Connection: 10 mm ring terminals Male/female: Female	
180350 Nato Plug		Std pkg 1		
	Voltage: 24 Amp: 250	Dim.: 70 mm ² Connection: Soldering	No./poles: 2 Connection: Soldering Male/female: Male	
181563 Nato Plug		Std pkg 1	Servicing: HC-CARGO 180197	
<i>Terminal: HC-CARGO 181670.</i>				
	Voltage: 24 Amp: 200	Dim.: 50 mm ² Connection: Solder/ crimp	No./poles: 2 Connection: Solder/crimp Male/female: Male Alternativ no.: 180325	
181611 Nato Plug		Std pkg 1	Servicing: HC-CARGO 180197	
<i>Terminal: HC-CARGO 180561.</i>				
	Voltage: 24 Amp: Max 300	Dim.: 35 mm ² Connection: Solder/ crimp	Material: Aluminium No./poles: 2 Connection: Solder/crimp Male/female: Male Approval: VG 96917	
181630 Nato Socket		Std pkg 1		
<i>Terminal: HC-CARGO 180560. Rubber Gasket: HC-CARGO 181671.</i>				
	Voltage: 24	Dim.: 35-50 mm ²	Colour: Yellow/black No./mounting holes: 4 No./poles: 2 Male/female: Female Approval: VG 96917	

193002 Nato Socket Std pkg 1

Terminal: HC-CARGO 180560. Nato Plug: HC-CARGO 180198. Rubber Gasket: HC-CARGO 181671.



Voltage: 24

Dim.: 35 mm²
ID/mount. hole: 6 mm
Dist. mount. holes:
82x49 mm
Connection: Soldering

Colour: Black
Material: Plastic
No./mounting holes: 4
No./poles: 2
Connection: Soldering
Cap: w/
Male/female: Female
Approval: VG 96917

SPARE PARTS

180560 Terminal Std pkg 2 Servicing: HC-CARGO 180197, 181630, 193002

Long.



Plug length: 67.2 mm
Cable size: 35-50 mm²

Male/female: Female

180561 Terminal Std pkg 2 Servicing: HC-CARGO 181611



Plug length: 42 mm
Cable size: 35 mm²

Male/female: Male/Female

181670 Terminal Std pkg 1 Servicing: HC-CARGO 180198, 180325, 181563



Plug length: 42 mm
Cable size: 50 mm²

Male/female: Male/Female

ACCESSORIES

180199 Nato Coupling Std pkg 1



Voltage: 24
Amp: 200

Dim.: 35-50 mm²

No./poles: 2
Approval: VG 96917

181671 Rubber Gasket Std pkg 1 Servicing: HC-CARGO 180197, 181630, 193002



Colour: Black
Material: EPDM rubber

Contact allocation for 7 - 13 and 14 - Pin Sockets

7-PIN plugs / sockets 12 V ISO 1724, DIN 72577 (12N)

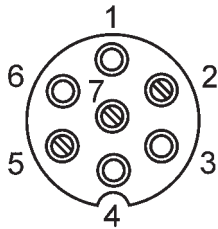

- 1/L) Left-hand direction indicator lamp.
- 2/54G) Rear fog lamp.
- 3/31) Common return.
- 4/R) Right-hand direction indicator lamp.
- 5/58L) Right-hand rear position and end-outline marker lamp, and rear-registration plate illumination device. 1)
- 6/54) Stop lamp.
- 7/58L) Left-hand rear position and end-outline marker lamp, and rear-registration plate illumination device. 1)

1) The rear registration plate illumination device shall be connected in such a manner that no lamp of such a device has a common connection with both contacts 5 and 7.

7-PIN plugs / sockets 12 V ISO 3732 (12S)

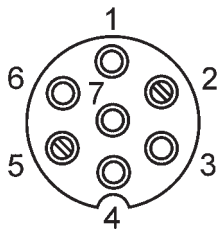

- 1/L) R Reversing lamp. 2)
- 2/54G) Coding for coupled trailer (within the plug pin no. 2 shall be connected to pin no. 3 to signal to the towing vehicle when a trailer is connected).
- 3/31) Common return (for contact no. 4-5).
- 4/R) Continuous power supply.
- 5/58L) Sensing device.
- 6/54) Power supply (controlled by ignition switch).
- 7/58L) Common return (for contact no. 6).

2) The common return for the circuit of this contact will normally be by contact no. 3/31 of the 12N connector according to ISO 1724.

7-PIN plugs / sockets 24 V ISO 1185, DIN 72579 (24N)

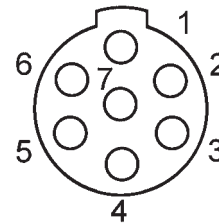

- 1/31) Common return.
- 2/58L) Left-hand rear position and end-outline marker lamp, and rear-registration plate illumination device. 3)
- 3/L) Left-hand direction indicator lamp.
- 4/54) Stop lamp.
- 5/R) Right-hand direction indicator lamp.
- 6/58R) Right-hand rear position and end-outline marker lamp, and rear-registration plate illumination device. 3)
- 7/54G) Braking control for trailers.

3) The rear registration plate illumination device shall be connected in such a manner that no lamp of such a device has a common connection with both contacts 2 and 6.

7-PIN plugs / sockets 24 V ISO 3731 (24S)

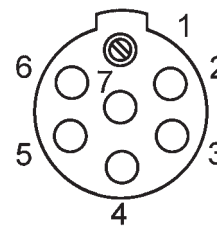

- 1/31) Common return.
- 2/58L) No allocation.
- 3/L) Reversing lamp.
- 4/54) Continuous power supply.
- 5/R) Control via common return.
- 6/58R) Power supply (controlled by ignition switch).
- 7/54G) Rear fog lamp.

13-PIN plugs / sockets
ISO 11446, DIN 72570
and 13-PIN Multicon

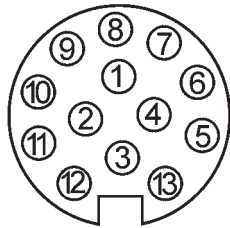

- 1) Left-hand direction indicator lamp.
- 2) Rear fog lamp.
- 3) Common return for contacts nos. 1 to 8. 1)
- 4) Right-hand direction indicator lamp.
- 5) Right-hand rear position and end-outline marker lamp, and rear-registration plate illumination device. 2)
- 6) Stop lamp.
- 7) Left-hand rear position and end-outline marker lamp, and rear-registration plate illumination device. 2)
- 8) Reversing lamp.
- 9) Continuous power supply.
- 10) Power supply (controlled by ignition switch).
- 11) Earth (for contact no. 10). 1)
- 12) Coding for coupled trailer (on the plug, pin no. 12 shall be bridged to pin no. 3 to return to the towing vehicle the information whether a trailer is coupled or not).
- 13) Common return (for contact no. 9). 1)

1) The three common return circuits shall not be connected electrically in the trailer.
2) The rear registration plate illumination device shall be connected such that no lamp of the device has a common connection with either contact 5 or 7.

VBG contact14

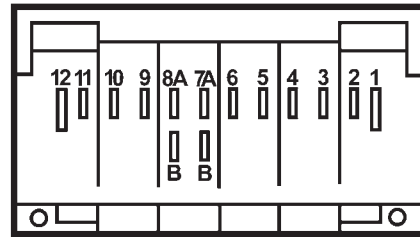

- 1) Common return.
- 2) Left hand direction indicator lamp.
- 3) Right hand direction indicator lamp.
- 4) Stop lamp.
- 5) Left-hand rear position and end-outline marker lamp, and rear-registration plate illumination device.
- 6) Right-hand rear position and end-outline marker lamp, and rear-registration plate illumination device.
- 7) a) Reversing b) Rear fog lamp. lamp.
- 8) a) b)
- 9)
- 10)
- 11)
- 12) Charging current.

Contact Allocation for ABS, EBS and ADR Connections

ABS / Plugs & Sockets ISO 7638

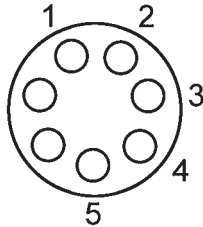

Contact allocation w/ electrical features

1)	Pos. (+) of solenoid valve	4/6 mm ² .
2)	Pos. (+) of electronic valve	1.5 mm ² .
3)	Neg. (-) of electronic valve	1.5 mm ² .
4)	Neg. (-) of solenoid valve	4/6 mm ² .
5)	Alarm equipment	1.5 mm ² .

EBS / Plugs & Sockets ISO 7638

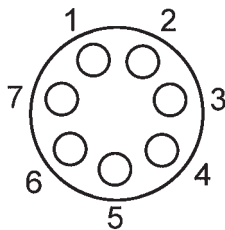

Contact allocation w/ electrical features

1)	Pos. (+) of solenoid valve	4/6 mm ² .
2)	Pos. (+) of electronic valve	1.5 mm ² .
3)	Neg. (-) of electronic valve	1.5 mm ² .
4)	Neg. (-) of solenoid valve	4/6 mm ² .
5)	Alarm equipment	1.5 mm ² .
6)	Reserved for data communication	1.5 mm ² .
7)	Reserved for data communication	1.5 mm ² .

13-PINS and 15-PINS plugs/sockets DIN 40050 ISO 12098

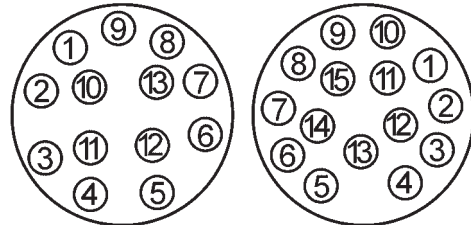

Contacts allocation

- 1) Left-hand direction indicator lamp.
- 2) Right-hand direction indicator lamp.
- 3) Rear fog lamp.
- 4) Common return.
- 5) Left-hand rear position and end-outline marker lamp, and rear registration plate illumination device. 1)
- 6) Right-hand rear position and end-outline marker lamp, and rear registration plate illumination device. 1)
- 7) Stop lamp.
- 8) Reversing lamp.
- 9) Power supply (+24V).
- 10) Worn brake lining sensor.
- 11) Pressure sensor for brakes.
- 12) Axle lifting device.
- 13) Common return for contacts 14 and 15.
- 14) Reserved for data communication. 2)
- 15) Reserved for data communication. 2)

1) The rear registration plate illumination shall be connected in such a manner that no lamp device has a common connection with both contacts 5 and 6.
 2) Contacts 14 and 15, which are not used at present, shall be blanked to accept later fitment of pins and sleeves for data transmission functions, which are being designed. These blanks shall permit 13-pole version to mate with 15-pole versions

FUSES							
TORPEDO							
	HC-CARGO	Std pkg	Ampere	Voltage	Dim.		
	190276	Pkg. 50	5	36	25x6 mm		
	190277	Pkg. 50	8	36	25x6 mm		
	190278	Pkg. 50	16	36	25x6 mm		
	190279	Pkg. 50	25	36	25x6 mm		
	190280	Pkg. 50	40	36	25x6 mm		
CAR RADIO FUSES							
	HC-CARGO	Std pkg	Ampere	Voltage	Dim.		
	190285	Pkg. 10	0.5	250	20x5 mm		
	192721	Pkg. 10	1	250	20x5 mm		
	190286	Pkg. 10	2	250	20x5 mm		
	190284	Pkg. 10	6.3	250	20x5 mm		
	190734	Pkg. 10	10	250	20x5 mm		
191534	Pkg. 10	20	250	20x5 mm			
GLASS							
29X6.3 MM							
	HC-CARGO	Std pkg	Ampere	Voltage	Dim.		
	190735	Pkg. 10	10	12	29x6.3 mm		
	191570	Pkg. 10	15	12	29x6.3 mm		
	191571	Pkg. 10	20	12	29x6.3 mm		
	190736	Pkg. 10	25	12	29x6.3 mm		
191572	Pkg. 10	30	12	29x6.3 mm			
32X6.3 MM							
	HC-CARGO	Std pkg	Ampere	Voltage	Dim.		
	190287	Pkg. 10	5	32	32x6.3 mm		
	190288	Pkg. 10	10	32	32x6.3 mm		
	190289	Pkg. 10	15	32	32x6.3 mm		
	190274	Pkg. 10	20	32	32x6.3 mm		
190275	Pkg. 10	35	32	32x6.3 mm			
MICRO BLADE							
	HC-CARGO	Std pkg	HC-CARGO	Std pkg	Ampere	Voltage	Colour
	193319	Pkg. 1	193213	Pkg. 50	5	32	Tan
	193320	Pkg. 1	193214	Pkg. 50	7.5	32	Brown
	193321	Pkg. 1	193215	Pkg. 50	10	32	Red
	193322	Pkg. 1	193216	Pkg. 50	15	32	Blue
	193323	Pkg. 1	193217	Pkg. 50	20	32	Yellow
	193324	Pkg. 1	193218	Pkg. 50	25	32	Transparent
	193325	Pkg. 1	193219	Pkg. 50	30	32	Green
MICRO 3 BLADE FUSE							
	HC-CARGO	Std pkg	HC-CARGO	Std pkg	Ampere	Voltage	Colour
	193376	Pkg. 1	193380	Pkg. 50	5	32	Tan
	193379	Pkg. 1	193383	Pkg. 50	7.5	32	Brown
	193377	Pkg. 1	193381	Pkg. 50	10	32	Red
	193378	Pkg. 1	193382	Pkg. 50	15	32	Blue

MINI BLADE LOW PROFILE

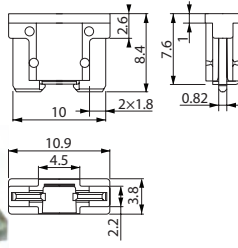

HC-CARGO	Std pkg	HC-CARGO	Std pkg	Ampere	Voltage	Colour
193336	Pkg. 1	192762	Pkg. 50	2	58	Grey
193337	Pkg. 1	192763	Pkg. 50	3	58	Purple
193338	Pkg. 1	192764	Pkg. 50	4	58	Pink
193339	Pkg. 1	192765	Pkg. 50	5	58	Tan
193340	Pkg. 1	192766	Pkg. 50	7.5	58	Brown
193341	Pkg. 1	192767	Pkg. 50	10	58	Red
193342	Pkg. 1	192768	Pkg. 50	15	58	Blue
193343	Pkg. 1	192769	Pkg. 50	20	58	Yellow
193344	Pkg. 1	192770	Pkg. 50	25	58	Nature
193345	Pkg. 1	192771	Pkg. 50	30	58	Green

MINI BLADE

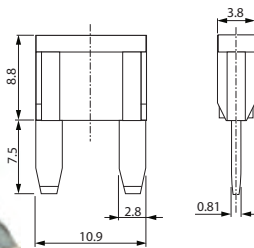

HC-CARGO	Std pkg	HC-CARGO	Std pkg	Ampere	Voltage	Colour
193326	Pkg. 1	191465	Pkg. 50	2	32	Grey
193327	Pkg. 1	191466	Pkg. 50	3	32	Purple
193328	Pkg. 1	191467	Pkg. 50	4	32	Pink
193329	Pkg. 1	191468	Pkg. 50	5	32	Tan
193330	Pkg. 1	191469	Pkg. 50	7.5	32	Brown
193331	Pkg. 1	191470	Pkg. 50	10	32	Red
193332	Pkg. 1	191471	Pkg. 50	15	32	Blue
193333	Pkg. 1	191472	Pkg. 50	20	32	Yellow
193334	Pkg. 1	191473	Pkg. 50	25	32	Nature
193335	Pkg. 1	191474	Pkg. 50	30	32	Green

ATO BLADE

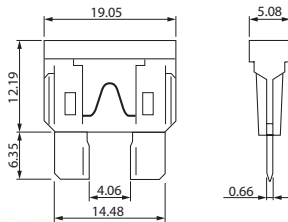

HC-CARGO	Std pkg	HC-CARGO	Std pkg	Ampere	Voltage	Colour
193273	Pkg. 1	191475	Pkg. 50	1	32	Black
193274	Pkg. 1	191476	Pkg. 50	2	32	Grey
193275	Pkg. 1	190053	Pkg. 50	3	32	Purple
193276	Pkg. 1	190054	Pkg. 50	4	32	Pink
193277	Pkg. 1	190055	Pkg. 50	5	32	Tan
193278	Pkg. 1	190056	Pkg. 50	7.5	32	Brown
193279	Pkg. 1	190057	Pkg. 50	10	32	Red
193280	Pkg. 1	190058	Pkg. 50	15	32	Blue
193281	Pkg. 1	190059	Pkg. 50	20	32	Yellow
193282	Pkg. 1	190060	Pkg. 50	25	32	Nature
193283	Pkg. 1	190061	Pkg. 50	30	32	Green
193284	Pkg. 1	192165	Pkg. 50	35	32	Dark blue
193285	Pkg. 1	191664	Pkg. 50	40	32	Orange

MAXI BLADE

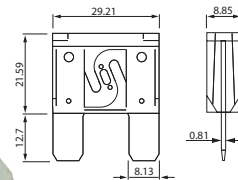

HC-CARGO	Std pkg	HC-CARGO	Std pkg	Ampere	Voltage	Colour
193286	Pkg. 1	191249	Pkg. 10	20	32	Yellow
193287	Pkg. 1	191250	Pkg. 10	30	32	Green
193288	Pkg. 1	191251	Pkg. 10	40	32	Orange
193289	Pkg. 1	191252	Pkg. 10	50	32	Red
193290	Pkg. 1	191253	Pkg. 10	60	32	Blue
193291	Pkg. 1	191254	Pkg. 10	70	32	Beige
193292	Pkg. 1	191255	Pkg. 10	80	32	Nature
193293	Pkg. 1	191256	Pkg. 10	100	32	Purple

MIDI

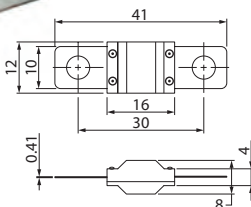

HC-CARGO	Std pkg	HC-CARGO	Std pkg	Ampere	Voltage	Colour
193309	Pkg. 1	192427	Pkg. 10	30	32	Orange
193310	Pkg. 1	192428	Pkg. 10	40	32	Green
193311	Pkg. 1	192429	Pkg. 10	50	32	Red
193312	Pkg. 1	192430	Pkg. 10	60	32	Yellow
193313	Pkg. 1	192431	Pkg. 10	70	32	Brown
193314	Pkg. 1	192432	Pkg. 10	80	32	White
193315	Pkg. 1	192433	Pkg. 10	100	32	Blue
193316	Pkg. 1	192434	Pkg. 10	125	32	Pink
193317	Pkg. 1	192435	Pkg. 10	150	32	Gray
193318	Pkg. 1	192976	Pkg. 10	200	32	Purple

MEGA

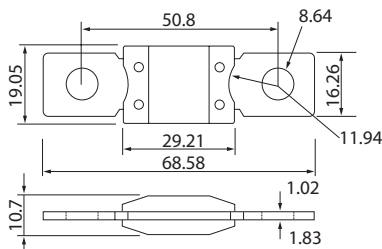

HC-CARGO	Std pkg	HC-CARGO	Std pkg	Ampere	Voltage	Colour
193294	Pkg. 1	192791	Pkg. 5	40	32	
193295	Pkg. 1	192792	Pkg. 5	60	32	
193296	Pkg. 1	192793	Pkg. 5	80	32	Red
193297	Pkg. 1	192049	Pkg. 5	100	32	Yellow
193298	Pkg. 1	192050	Pkg. 5	125	32	Green
193299	Pkg. 1	192051	Pkg. 5	150	32	Red
193300	Pkg. 1	192052	Pkg. 5	175	32	White
193301	Pkg. 1	192053	Pkg. 5	200	32	Blue
193302	Pkg. 1	192229	Pkg. 5	225	32	Brown
193303	Pkg. 1	192230	Pkg. 5	250	32	Pink
193304	Pkg. 1	192231	Pkg. 5	300	32	Grey
193305	Pkg. 1	192977	Pkg. 5	350	32	Green
193306	Pkg. 1	192978	Pkg. 5	400	32	Purple
193307	Pkg. 1	192979	Pkg. 5	450	32	Yellow
193308	Pkg. 1	192980	Pkg. 5	500	32	Brown

SMART GLOW

MINI

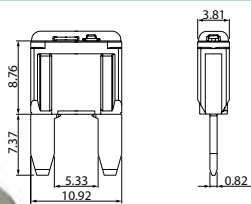
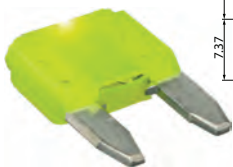

HC-CARGO	Std pkg	HC-CARGO	Std pkg	Ampere	Voltage	Colour
193538	Pkg. 1	193530	Pkg. 100	3	32	Purple
193539	Pkg. 1	193531	Pkg. 100	5	32	Tan
193540	Pkg. 1	193532	Pkg. 100	7.5	32	Brown
193541	Pkg. 1	193533	Pkg. 100	10	32	Red
193542	Pkg. 1	193534	Pkg. 100	15	32	Blue
193543	Pkg. 1	193535	Pkg. 100	20	32	Yellow
193544	Pkg. 1	193536	Pkg. 100	25	32	Transparent
193545	Pkg. 1	193537	Pkg. 100	30	32	Green

ATO

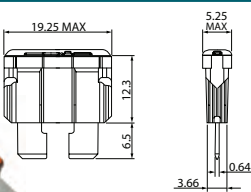
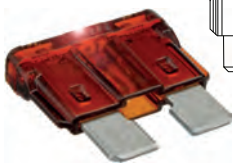

HC-CARGO	Std pkg	HC-CARGO	Std pkg	Ampere	Voltage	Colour
193555	Pkg. 1	193547	Pkg. 100	3	32	Purple
193556	Pkg. 1	193548	Pkg. 100	5	32	Tan
193557	Pkg. 1	193549	Pkg. 100	7.5	32	Brown
193558	Pkg. 1	193550	Pkg. 100	10	32	Red
193559	Pkg. 1	193551	Pkg. 100	15	32	Blue
193560	Pkg. 1	193552	Pkg. 100	20	32	Yellow
193561	Pkg. 1	193553	Pkg. 100	25	32	Transparent
193562	Pkg. 1	193554	Pkg. 100	30	32	Green

MAXI

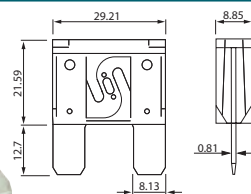

HC-CARGO	Std pkg	HC-CARGO	Std pkg	Ampere	Voltage	Colour
193572	Pkg. 1	193564	Pkg. 100	20	32	Yellow
193573	Pkg. 1	193565	Pkg. 100	30	32	Grey
193574	Pkg. 1	193566	Pkg. 100	40	32	Orange
193575	Pkg. 1	193567	Pkg. 100	50	32	Red
193576	Pkg. 1	193568	Pkg. 100	60	32	Blue
193577	Pkg. 1	193569	Pkg. 100	70	32	Beige
193578	Pkg. 1	193570	Pkg. 100	80	32	Transparent
193579	Pkg. 1	193571	Pkg. 100	100	32	Purple

HSB

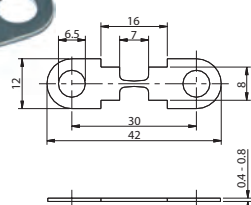

HC-CARGO	Std pkg	Ampere	Voltage	Dim.
192798	Pkg. 10	30	32	42x12 mm
192799	Pkg. 10	40	32	42x12 mm
192800	Pkg. 10	50	32	42x12 mm
192801	Pkg. 10	60	32	42x12 mm
192802	Pkg. 10	80	32	42x12 mm
192803	Pkg. 10	110	32	42x12 mm
192804	Pkg. 10	150	32	42x12 mm
192805	Pkg. 10	175	32	42x12 mm

PAL 293

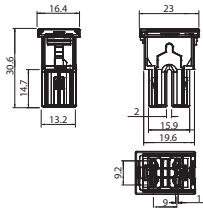

HC-CARGO	Std pkg	Ampere	Voltage	Colour
191638	Pkg. 5	20	32	Blue
191152	Pkg. 5	30	32	Pink
191153	Pkg. 5	40	32	Green
191970	Pkg. 5	50	32	Red
191154	Pkg. 5	60	32	Yellow

PAL 2935

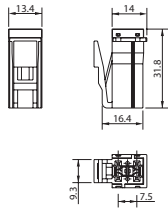

HC-CARGO	Std pkg	Ampere	Voltage	Colour
191830	Pkg. 5	25	32	Brown
191831	Pkg. 5	30	32	Green
191832	Pkg. 5	45	32	Red
191833	Pkg. 5	65	32	Black
191834	Pkg. 5	75	32	Grey

PAL 2938

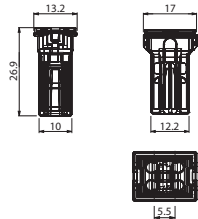

HC-CARGO	Std pkg	Ampere	Voltage	Colour
191672	Pkg. 5	30	32	Pink
191673	Pkg. 5	40	32	Green

PAL 294

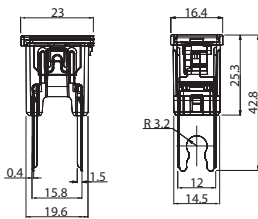

HC-CARGO	Std pkg	Ampere	Voltage	Colour
191155	Pkg. 5	30	32	Pink
191973	Pkg. 5	40	32	Green
191974	Pkg. 5	50	32	Red
191156	Pkg. 5	60	32	Yellow
191975	Pkg. 5	70	32	Brown
191157	Pkg. 5	80	32	Black
191971	Pkg. 5	100	32	Dark blue
192760	Pkg. 5	120	32	White

PAL 295

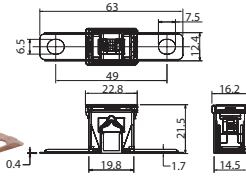
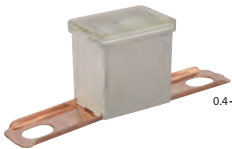

HC-CARGO	Std pkg	Ampere	Voltage	Colour
191628	Pkg. 5	30	32	Pink
191629	Pkg. 5	40	32	Green
191630	Pkg. 5	50	32	Red
191631	Pkg. 5	60	32	Yellow
191632	Pkg. 5	70	32	Brown
191972	Pkg. 5	80	32	Black
191977	Pkg. 5	100	32	Dark blue
192982	Pkg. 5	120	32	White

PAL 283

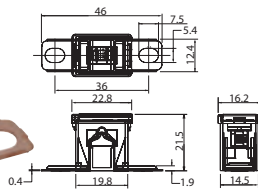

HC-CARGO	Std pkg	Ampere	Voltage	Colour
191633	Pkg. 5	30	32	Pink
191634	Pkg. 5	40	32	Green
191635	Pkg. 5	50	32	Red
191636	Pkg. 5	60	32	Yellow
191637	Pkg. 5	70	32	Brown
191976	Pkg. 5	80	32	Black
191978	Pkg. 5	100	32	Dark blue
192981	Pkg. 5	120	32	White

PAL JCASE								
		HC-CARGO	Std pkg	Ampere	Voltage	Colour		
		192105	Pkg. 5	20	32	Blue		
		192106	Pkg. 5	30	32	Pink		
		192107	Pkg. 5	40	32	Green		
		192108	Pkg. 5	50	32	Red		
		192109	Pkg. 5	60	32	Yellow		
	PAL LOW PROFILE							
		HC-CARGO	Std pkg	Ampere	Voltage	Colour		
		192779	Pkg. 5	20	58	Blue		
		192780	Pkg. 5	25	58	White		
		192781	Pkg. 5	30	58	Pink		
		192782	Pkg. 5	40	58	Green		
		192783	Pkg. 5	50	58	Red		
		192784	Pkg. 5	60	58	Yellow		
STRIP								
30 MM								
		HC-CARGO	Std pkg	Ampere	Voltage	Length	Lever dim.	DIN norm
		192705	Pkg. 10	25	36	41 mm	5.5 mm	72581/2
		191184	Pkg. 10	30	36	41 mm	5.5 mm	72581/2
		191185	Pkg. 10	40	36	41 mm	5.5 mm	72581/2
		191186	Pkg. 10	50	36	41 mm	5.5 mm	72581/2
		191187	Pkg. 10	60	36	41 mm	5.5 mm	72581/2
		191188	Pkg. 10	80	36	41 mm	5.5 mm	72581/2
		191189	Pkg. 10	100	36	41 mm	5.5 mm	72581/2
		192338	Pkg. 10	150	36	41 mm	5.5 mm	72581/2
60 MM								
9 MM								
		HC-CARGO	Std pkg	Ampere	Voltage	Length	Lever dim.	DIN norm
		192298	Pkg. 10	50	48	82 mm	9 mm	43560
		192299	Pkg. 10	80	48	82 mm	9 mm	43560
		192300	Pkg. 10	100	48	82 mm	9 mm	43560
		192301	Pkg. 10	125	48	82 mm	9 mm	43560
		192302	Pkg. 10	160	48	82 mm	9 mm	43560
		192303	Pkg. 10	200	48	82 mm	9 mm	43560
		192304	Pkg. 10	250	48	82 mm	9 mm	43560
11 MM								
		HC-CARGO	Std pkg	Ampere	Voltage	Length	Lever dim.	DIN norm
		192305	Pkg. 10	35	48	82 mm	11 mm	43560
		192306	Pkg. 10	50	48	82 mm	11 mm	43560
		192307	Pkg. 10	80	48	82 mm	11 mm	43560
		192308	Pkg. 10	100	48	82 mm	11 mm	43560
		192309	Pkg. 10	125	48	82 mm	11 mm	43560
		192310	Pkg. 10	160	48	82 mm	11 mm	43560
		192311	Pkg. 10	200	48	82 mm	11 mm	43560
		192312	Pkg. 10	250	48	82 mm	11 mm	43560
		192313	Pkg. 10	300	48	82 mm	11 mm	43560
		192314	Pkg. 10	355	48	82 mm	11 mm	43560
		192315	Pkg. 10	425	48	82 mm	11 mm	43560
		192316	Pkg. 10	500	48	82 mm	11 mm	43560

60 MM, CLOSED TYPE

9 MM

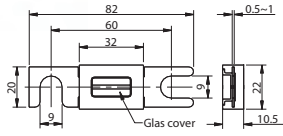

HC-CARGO	Std pkg	Ampere	Voltage	Length	Lever dim.	DIN norm
192317	Pkg. 5	35	48	82 mm	9 mm	43560
192318	Pkg. 5	50	48	82 mm	9 mm	43560
192319	Pkg. 5	80	48	82 mm	9 mm	43560
192320	Pkg. 5	100	48	82 mm	9 mm	43560
192321	Pkg. 5	125	48	82 mm	9 mm	43560
192322	Pkg. 1	160	48	82 mm	9 mm	43560
192323	Pkg. 5	200	48	82 mm	9 mm	43560
192324	Pkg. 5	250	48	82 mm	9 mm	43560

11 MM

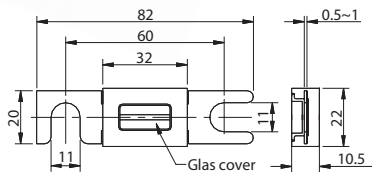

HC-CARGO	Std pkg	Ampere	Voltage	Length	Lever dim.	DIN norm
192325	Pkg. 5	35	48	82 mm	11 mm	43560
192326	Pkg. 5	50	48	82 mm	11 mm	43560
192327	Pkg. 5	80	48	82 mm	11 mm	43560
192328	Pkg. 5	100	48	82 mm	11 mm	43560
192329	Pkg. 5	125	48	82 mm	11 mm	43560
192330	Pkg. 5	160	48	82 mm	11 mm	43560
192331	Pkg. 5	200	48	82 mm	11 mm	43560
192332	Pkg. 5	250	48	82 mm	11 mm	43560
192333	Pkg. 5	275	48	82 mm	11 mm	43560
192334	Pkg. 5	300	48	82 mm	11 mm	43560
192335	Pkg. 5	355	48	82 mm	11 mm	43560
192336	Pkg. 5	425	48	82 mm	11 mm	43560
192337	Pkg. 5	500	48	82 mm	11 mm	43560

COMPACT

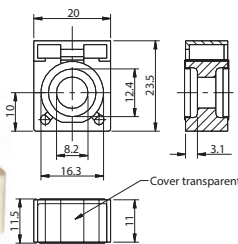

HC-CARGO	Std pkg	Ampere	Voltage	Dim.	DIN norm	
192538	Pkg. 5	50	58	20x23.5 mm	72581/3F	w/ ceramic body.
192539	Pkg. 5	75	58	20x23.5 mm	72581/3F	w/ ceramic body.
192540	Pkg. 5	100	58	20x23.5 mm	72581/3F	w/ ceramic body.
192541	Pkg. 5	125	58	20x23.5 mm	72581/3F	w/ ceramic body.
192542	Pkg. 5	150	58	20x23.5 mm	72581/3F	w/ ceramic body.
192543	Pkg. 5	175	58	20x23.5 mm	72581/3F	w/ ceramic body.
192544	Pkg. 5	200	58	20x23.5 mm	72581/3F	w/ ceramic body.
192545	Pkg. 5	250	58	20x23.5 mm	72581/3F	w/ ceramic body.
192546	Pkg. 5	300	58	20x23.5 mm	72581/3F	w/ ceramic body.

ACCESSORIES

192547 Battery Terminal

Std pkg 5

Servicing: Compact fuses - Visit our web catalogue for further information



Amp: 250

Polarity: Positive

No./connections: 1
Tin plated: Yes

192548 Battery Terminal

Std pkg 5

Servicing: Compact fuses - Visit our web catalogue for further information



Amp: 250

Polarity: Positive

No./connections: 2
Tin plated: Yes

192549 Nut

Std pkg 1

Servicing: Compact fuses - Visit our web catalogue for further information



FUSE CARDS

TORPEDO TYPE

190002 Fuse Card

Std pkg 1

Contains: 1x5 A, 4x8 A, 3x16 A, 1x25 A, 1x2 A.



Voltage: 36

Type: Torpedo

ATO BLADE TYPE

190004 Fuse Card

Std pkg 1

Contains: 1x3 A, 1x5 A, 1x7.5 A, 2x10 A, 1x15 A, 2x20 A, 1x25 A, 1x30 A.

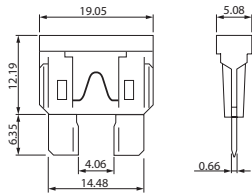

Voltage: 32

Type: ATO

TESTER/EXTRACTORS

210702 Fuse Tester/Puller

Std pkg 1

Servicing: Mini and ATO blade fuses. Max 24 V - Visit our web catalogue for further information

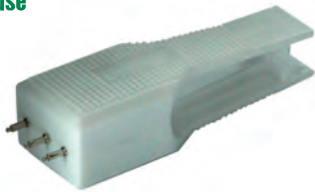

210841 Extractor

Std pkg 10

Servicing: Mini and ATO blade fuse - Visit our web catalogue for further information



210842 Extractor

Std pkg 10

Servicing: Maxi fuses - Visit our web catalogue for further information



VARIOUS
192861 Fuse

Std pkg 10

Servicing: HC-CARGO 211101, 211102

 Voltage: 250
Amp: 10

Dim.: 31x6 mm

Yes

192862 Fuse

Std pkg 1

Servicing: HC-CARGO 211101

 Voltage: 250
Amp: 10

Dim.: 25x6 mm

Yes

FUSE BOXES
TORPEDO TYPE
190768 Fuse Box

Std pkg 1

w/ 8 A fuse.

 Type/fuse: Torpedo
Plug type: Screw
Bracket colour: Transparent
Outlets: 2 way
No./fuses: 2
Fuse incl.: Yes

190770 Fuse Box

Std pkg 1

w/ 8 A fuse.

 Type/fuse: Torpedo
Plug type: Screw
Bracket colour: Transparent
Outlets: 4 way
No./fuses: 4
Fuse incl.: Yes

190772 Fuse Box

Std pkg 1

w/ 8 A fuse.







 Type/fuse: Torpedo
Plug type: Screw
Bracket colour: Transparent
Outlets: 6 way
No./fuses: 6
Fuse incl.: Yes

190774 Fuse Box

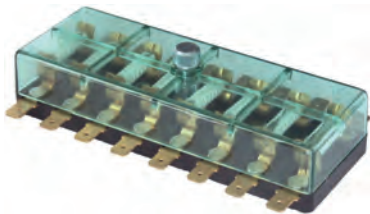
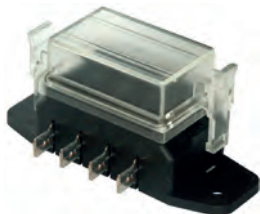







Std pkg 1

w/ 8 A fuse.

 Type/fuse: Torpedo
Plug type: Screw
Bracket colour: Transparent
Outlets: 8 way
No./fuses: 8
Fuse incl.: Yes

190775 Fuse Box		Std pkg 1			
w/ 8 A fuse.					
					Type/fuse: Torpedo Plug type: Flat Bracket colour: Transparent Outlets: 8 way No./fuses: 8 Fuse incl.: Yes
ATO BLADE TYPE					
191161 Fuse Box		Std pkg 1			
					Type/fuse: ATO Plug type: Flat Bracket colour: Transparent Outlets: 4 way No./fuses: 4 Fuse incl.: No
191162 Fuse Box		Std pkg 1			
					Type/fuse: ATO Plug type: Flat Bracket colour: Transparent Outlets: 6 way No./fuses: 6 Fuse incl.: No
191163 Fuse Box		Std pkg 1			
					Type/fuse: ATO Plug type: Flat Bracket colour: Transparent Outlets: 8 way No./fuses: 8 Fuse incl.: No
191164 Fuse Box		Std pkg 1			
					Type/fuse: ATO Plug type: Flat Bracket colour: Transparent Outlets: 4 way No./fuses: 4 Fuse incl.: No
191165 Fuse Box		Std pkg 1			
					Type/fuse: ATO Plug type: Flat Bracket colour: Transparent Outlets: 6 way No./fuses: 6 Fuse incl.: No
191409 Fuse Box		Std pkg 1			
Kit set w/ cover, terminlas and terminal lock. Can be assembled in rows.					
					Type/fuse: ATO Plug type: Flat Bracket colour: Transparent Outlets: 16 way No./fuses: 16 Fuse incl.: No

		EL. SPECIFICATIONS	DIMENSIONS	ADDITIONAL SPECIFICATIONS
192057	Fuse Box	Std pkg 1	Servicing: Blade fuses up to 15 A - Visit our web catalogue for further information	
				Type/fuse: ATO Plug type: Flat Bracket colour: Transparent Outlets: 5 way No./fuses: 5 Fuse incl.: No
192058	Fuse Box	Std pkg 1	Servicing: Blade fuses up to 15 A - Visit our web catalogue for further information	
				Type/fuse: ATO Plug type: Flat Bracket colour: Transparent Outlets: 5 way No./fuses: 5 Fuse incl.: No
192484	Fuse Box	Std pkg 1		
				Type/fuse: ATO Plug type: Flat Bracket colour: Transparent Outlets: 8 way No./fuses: 8 Fuse incl.: No
192685	Fuse Box	Std pkg 1		
<i>Multi Socket Set: HC-CARGO 192686.</i>				
				Type/fuse: ATO Plug type: Flat Bracket colour: Transparent Outlets: 8 way No./fuses: 8 Fuse incl.: No
192686	Multi Socket Set	Std pkg 1	Servicing: HC-CARGO 192685	
<i>w/ 4 multi plugs and 2 connectors in each.</i>				
				Plug: Multiplug
FUSE HOLDERS				
TORPEDO TYPE				
190273	Fuse Holder	Std pkg 10		
		Amp/max: 8		Type/fuse: Torpedo Plug type: Screw
190787	Fuse Holder	Std pkg 10		
		Amp/max: 8		Type/fuse: Torpedo Plug type: Flat

191012 Fuse Holder		Std pkg 10	
w/ 16 A fuse.			
		Amp/max: 16	Type/fuse: Torpedo Plug type: Screw
GLASS TYPE			
190957 Fuse Holder		Std pkg 1	
w/ 2 A radio fuse.			
		Amp/max: <2	Type/fuse: Radio glass Cable incl.: Yes
MINI BLADE TYPE			
191768 Fuse Holder		Std pkg 10	
		Amp/max: 20	Cable dim. max: 2 mm ²
		Type/fuse: Mini blade Material: Rubber Splash proof: Yes Cable incl.: Yes	
191769 Fuse Holder		Std pkg 10	
		Amp/max: 30	Cable dim. max: 3 mm ²
		Type/fuse: Mini blade Material: Rubber Splash proof: Yes Cable incl.: Yes	
ATO BLADE TYPE			
190870 Fuse Holder		Std pkg 10	
Scotch lock type.			
		Cable dim. max: 2 mm ² Cable dia. min: 0.8 mm ²	Type/fuse: ATO Colour: Blue
191001 Fuse Holder		Std pkg 10	
Can be assembled in rows.			
			Type/fuse: ATO Plug type: Flat
			

EL. SPECIFICATIONS		DIMENSIONS	ADDITIONAL SPECIFICATIONS
191054 Fuse Holder Std pkg 10 Servicing: HC-CARGO 191774 <i>Can be assembled in rows. Fixing Plate: HC-CARGO 191053. Cover: HC-CARGO 191055.</i>			
	Amp/max: 20		Type/fuse: ATO Plug type: Flat
191640 Fuse Holder Std pkg 10			
	Amp/max: 20	Cable dim. max: 1.3 mm ²	Type/fuse: ATO Material: Rubber Splash proof: Yes Cable incl.: Yes
191680 Fuse Holder Std pkg 10			
	Amp/max: 30	Cable dim. max: 3.3 mm ²	Type/fuse: ATO Material: Rubber Splash proof: Yes Cable incl.: Yes
191774 Fuse Holder Kit Std pkg 1 <i>Contains: 1x HC-CARGO 191053. 1x HC-CARGO 191054. 1x HC-CARGO 191055.</i>			
	Amp/max: 20		Type/fuse: ATO
192631 Fuse Holder Std pkg 10 <i>w/ secondary lock. w/ cover and silicone gasket. Terminal: HC-CARGO 191870, 191871, 191872. Single wire seal: HC-CARGO 192647. Fixing Plate: HC-CARGO 192638, 192639.</i>			
	Amp/max: 5		Type/fuse: ATO Colour: Nature Splash proof: Yes Holder incl.: No
192632 Fuse Holder Std pkg 10 <i>w/ secondary lock. w/ cover and silicone gasket. Terminal: HC-CARGO 191870, 191871, 191872. Single wire seal: HC-CARGO 192647.</i>			
	Amp/max: 7.5		Type/fuse: ATO Colour: Brown Splash proof: Yes Holder incl.: No
192633 Fuse Holder Std pkg 10 <i>w/ secondary lock. w/ cover and silicone gasket. Terminal: HC-CARGO 191870, 191871, 191872. Single wire seal: HC-CARGO 192647.</i>			
	Amp/max: 10		Type/fuse: ATO Colour: Red Splash proof: Yes Holder incl.: No

EL. SPECIFICATIONS		DIMENSIONS	ADDITIONAL SPECIFICATIONS
192634 Fuse Holder Std pkg 10 <i>w/ secondary lock. w/ cover and silicone gasket. Terminal: HC-CARGO 191870, 191871, 191872. Single wire seal: HC-CARGO 192647.</i>			
	Amp/max: 15		Type/fuse: ATO Colour: Blue Splash proof: Yes Holder incl.: No
192635 Fuse Holder Std pkg 10 <i>Servicing: Universal - Visit our web catalogue for further information</i> <i>w/ secondary lock. w/ cover and silicone gasket. Terminal: HC-CARGO 191870, 191871, 191872. Single wire seal: HC-CARGO 192647.</i>			
	Amp/max: 20		Type/fuse: ATO Colour: Yellow Splash proof: Yes Holder incl.: No
192636 Fuse Holder Std pkg 10 <i>w/ secondary lock. w/ cover and silicone gasket. Terminal: HC-CARGO 191870, 191871, 191872. Single wire seal: HC-CARGO 192647.</i>			
	Amp/max: 25		Type/fuse: ATO Colour: White Splash proof: Yes Holder incl.: No
192637 Fuse Holder Std pkg 10 <i>w/ secondary lock. w/ cover and silicone gasket. Terminal: HC-CARGO 191870, 191871, 191872. Single wire seal: HC-CARGO 192647. Fixing Plate: HC-CARGO 192638, 192639.</i>			
	Amp/max: 30		Type/fuse: ATO Colour: Green Splash proof: Yes Holder incl.: No
192759 Fuse Holder Std pkg 10 <i>Servicing: HC-CARGO 191411, 191412, 191413, 191870, 191871, 191872</i> <i>Can be assembled in rows. w/o terminals.</i>			
			Type/fuse: ATO
192794 Fuse Holder Std pkg 10 <i>w/ mounting bracket. Can be built together w/ relay multi plug. Terminal: HC-CARGO 192986.</i>			
			Type/fuse: ATO Plug type: Flat

MAXI BLADE TYPE
191257 Maxi Blade Fuse Holder Std pkg 5 Servicing: HC-CARGO 191775

To be assembled in rows. w/o terminals. Terminals: HC-CARGO 191260, 191261, 191262 (2 pcs). Cover: HC-CARGO 191258. Fixing Plate: HC-CARGO 191259.

 Type/fuse: Maxi blade
 Alternativ no.: 193294

191775 Maxi Blade Fuse Holder Kit Std pkg 1

Contains: 1x HC-CARGO 191257. 1x HC-CARGO 191258. 1x HC-CARGO 191259. 2x HC-CARGO 191261.

Type/fuse: Maxi blade

192132 Maxi Blade Fuse Holder Std pkg 5 Servicing: HC-CARGO 192137, 192136

To be assembled in rows. w/o terminals. w/ bracket. Terminals: HC-CARGO 192134, 192135 (2 pcs). Cover: HC-CARGO 192133.

Amp/max: 80

Type/fuse: Maxi blade

192136 Maxi Blade Fuse Holder Kit Std pkg 1

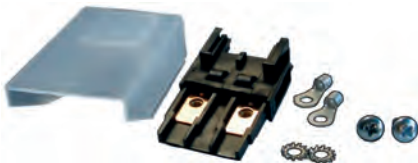
Contains: 1x HC-CARGO 192132, 192133. 2x HC-CARGO 192134, 191554, 190612.

Amp/max: 80

 Cable dim. max:
 6 mm²
 Cable dia. min:
 2.5 mm²

 Type: Set
 Type/fuse: Maxi blade

192137 Maxi Blade Fuse Holder Kit Std pkg 1

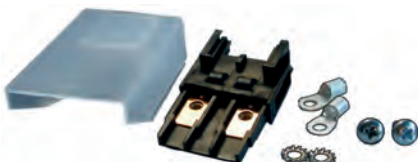
Contains: 1x HC-CARGO 192132, 192133. 2x HC-CARGO 192135, 191554, 190612.

Amp/max: 80

 Cable dim. max:
 10 mm²
 Cable dia. min: 5 mm²

 Type: Set
 Type/fuse: Maxi blade

192421 Maxi Blade Fuse Holder Kit Std pkg 1

Contains: 1 splash/waterproof holder, 1 cover, 2 terminals for 4-6 mm cable (HC-CARGO 192486), 2 rubber wire seals.

Amp/max: 60

 Cable dim. max:
 6 mm²
 Cable dia. min: 4 mm²

 Type: Set
 Type/fuse: Maxi blade
 Splash proof: Yes
 Holder incl.: Yes
 Cable incl.: Yes

192422 Maxi Blade Fuse Holder Kit Std pkg 1

Contains: 1 cover, 2 terminals for 6-10 mm cable, 2 rubber wire seals.



Amp/max: 60

 Cable dim. max:
10 mm²
Cable dia. min: 6 mm²

 Type: Set
Type/fuse: Maxi blade
Splash proof: Yes
Holder incl.: Yes
Cable incl.: Yes

192687 Maxi Blade Fuse Holder Kit Std pkg 1

 Contains: 1 splash waterproof holder, 1 cover, 2 terminals for 16 mm² cable and 2 wire seals.

193016 Fuse Holder

Std pkg 1



Amp/max: 60

 Cable dia. min:
13 mm²

 Type/fuse: Maxi
Colour: Black
Cable incl.: Yes

MIDI TYPE
192436 Fuse Holder

Std pkg 1



Amp/max: 200

Type/fuse: Midi

MEGA TYPE
192055 Mega Blade Fuse Holder

Std pkg 1

2 screws M8.

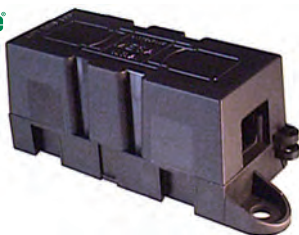

Amp/max: 500

 Type/fuse: Mega
Plug type: Screw

192423 Mega Blade Fuse Holder

Std pkg 1

2 screws M8. Cover: HC-CARGO 192424.



Amp/max: 250

 Type/fuse: Mega
Plug type: Screw
Splash proof: Yes

MICRO BLADE TYPE

192864 Fuse Holder Std pkg 10



Amp/max: 10

 Type/fuse: Micro
 Colour: Black
 Material: Shockproof plastic
 Splash proof: Yes
 Cable incl.: Yes

JCASE TYPE

192952 Fuse Holder Std pkg 1



Amp/max: 60

 Type: Single
 Type/fuse: JCase
 Colour: Black
 Material: Rubber
 Splash proof: Yes
 Cable incl.: Yes

Can be used together w/ JCase + JCase low profile fuses.
VARIOUS

192344 Fuse Holder Std pkg 1



2 screws M10. w/o fuse.

 Type: Single
 Type/fuse: DIN 43560 strip
 Plug type: Screw

191190 Fuse Holder Std pkg 10

w/o fuse. w/ 2xM5 screws and washers.



Type/fuse: DIN 72581 strip

ACCESSORIES

191053 Fixing Plate Std pkg 25 Servicing: HC-CARGO 191054, 191774

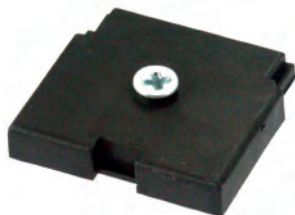

Type/fuse: ATO

191055 Cover Std pkg 25 Servicing: HC-CARGO 191054, 191774

 Type/fuse: ATO
 Material: Polycarbonate

		EL. SPECIFICATIONS	DIMENSIONS	ADDITIONAL SPECIFICATIONS
191258	Cover	Std pkg 10	Servicing: HC-CARGO 191257, 191775	Type/fuse: Maxi
				
191259	Fixing Plate	Std pkg 10	Servicing: HC-CARGO 191257, 191775	Type/fuse: Maxi
				
192133	Cover	Std pkg 10	Servicing: HC-CARGO 192132, 192136, 192137	Type/fuse: Maxi
				
192424	Cover	Std pkg 1	Servicing: HC-CARGO 192423	Type/fuse: Mega
				
192638	Fixing Plate	Std pkg 10	Servicing: HC-CARGO 192631, 192637	Type/fuse: ATO
				
192639	Fixing Plate	Std pkg 10	Servicing: HC-CARGO 192631, 192637	Type/fuse: ATO
				
ADAPTERS				
192419	Fuse Adapter	Std pkg 5		
For ATO blade fuse up to 10 A. Adapter for installation of extra fuse for accessories.				
		Voltage: 12 Amp: <10		Type: ATO Terminals: 2

192420 Fuse Adapter Std pkg 5

For Mini blade fuse up to 10 A. Adapter for installation of extra fuse for accessories. A safe and economical alternative to splicing.

 Voltage: 12
Amp: <10

 Type: Mini blade
Terminals: 2

193265 Fuse Adapter Std pkg 5

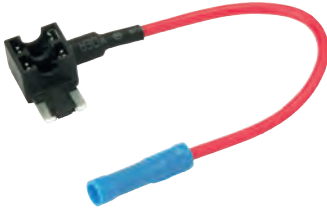
For Mini Low Profile fuse up to 10 A. Adapter for installation of extra fuse for accessories.

 Voltage: 12
Amp: 10

 Type: Mini Low Profile
Terminals: 2

INDICATOR LIGHTS

180014 Indicator Light Std pkg 5

Voltage: 12/24

 Mount. hole size:
17 mm

 Socket type: BA9s
Colour: Blue
Material: Shockproof plastic
No./terminals w/screw: 2
Bulb incl.: Yes
DIN norm: 72601

180015 Indicator Light Std pkg 5

Voltage: 12/24

 Mount. hole size:
17 mm

 Socket type: BA9s
Colour: Orange
Material: Shockproof plastic
No./terminals w/screw: 2
Bulb incl.: No
DIN norm: 72601

180016 Indicator Light Std pkg 5

Voltage: 12/24

 Mount. hole size:
17 mm

 Socket type: BA9s
Colour: Green
Material: Shockproof plastic
No./terminals w/screw: 2
Bulb incl.: Yes
DIN norm: 72601

180017 Indicator Light Std pkg 5

Voltage: 12/24

 Mount. hole size:
17 mm









 Socket type: BA9s
Colour: Red
Material: Shockproof plastic
No./terminals w/screw: 2
Bulb incl.: Yes
DIN norm: 72601







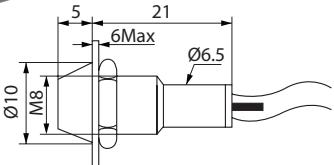

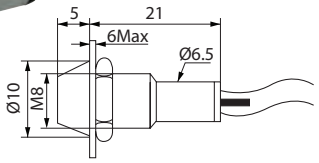

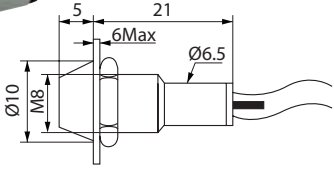

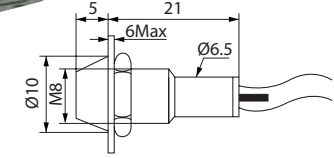
180343 Indicator Light Std pkg 5

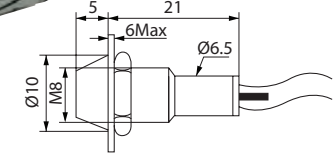
 Voltage: 12
Watt: 1.2

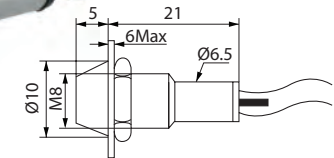
 Terminals: 2.8 mm
Mount. hole size:
10 mm

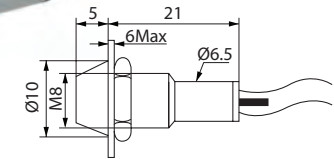
 Type/terminal: Flat
Colour: Orange
Material: Shockproof plastic
Terminals: 2
Bulb incl.: Yes

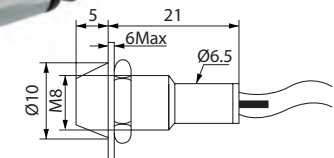

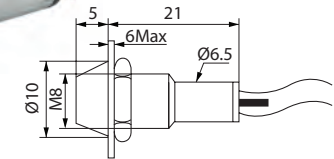
		EL. SPECIFICATIONS	DIMENSIONS	ADDITIONAL SPECIFICATIONS
180344	Indicator Light	Std pkg 5	Servicing: Renault, VW - Visit our web catalogue for further information	
		Voltage: 12 Watt: 1.2	Terminals: 2.8 mm Mount. hole size: 10 mm	Type/terminal: Flat Colour: Green Material: Shockproof plastic Terminals: 2 Bulb incl.: Yes
180345	Indicator Light	Std pkg 5		
		Voltage: 12 Watt: 1.2	Terminals: 2.8 mm Mount. hole size: 10 mm	Type/terminal: Flat Colour: Red Material: Shockproof plastic Terminals: 2 Bulb incl.: Yes
180346	Indicator Light	Std pkg 5		
		Voltage: 24 Watt: 1.2	Terminals: 2.8 mm Mount. hole size: 10 mm	Type/terminal: Flat Colour: Orange Material: Shockproof plastic Terminals: 2 Bulb incl.: Yes
180347	Indicator Light	Std pkg 5		
		Voltage: 24 Watt: 1.2	Terminals: 2.8 mm Mount. hole size: 10 mm	Type/terminal: Flat Colour: Green Material: Shockproof plastic Terminals: 2 Bulb incl.: Yes
180348	Indicator Light	Std pkg 5		
		Voltage: 24 Watt: 1.2	Terminals: 2.8 mm Mount. hole size: 10 mm	Type/terminal: Flat Colour: Red Material: Shockproof plastic Terminals: 2 Bulb incl.: Yes
LED				
181570	Indicator Light	Std pkg 5		
EN60947-5-1, IEC947-5-1.				
		Voltage: 24	Mount. hole size: 8 mm	Type/terminal: Solder Bulb type: LED Colour: Red Material: Nickel plated brass
181571	Indicator Light	Std pkg 5		
		Voltage: 24	Mount. hole size: 8 mm	Type/terminal: Solder Bulb type: LED Colour: Green Material: Nickel plated brass

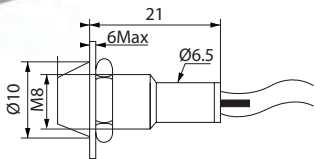
		EL. SPECIFICATIONS	DIMENSIONS	ADDITIONAL SPECIFICATIONS
181572	Indicator Light	Std pkg 5		
		Voltage: 24	Mount. hole size: 8 mm	Type/terminal: Solder Bulb type: LED Colour: Yellow Material: Nickel plated brass
181573	Indicator Light	Std pkg 5		
		Voltage: 24	Mount. hole size: 8 mm	Type/terminal: Solder Bulb type: LED Colour: Blue Material: Nickel plated brass Alternativ no.: 181636
181574	Indicator Light	Std pkg 5		
		Voltage: 24	Mount. hole size: 8 mm	Type/terminal: Solder Bulb type: LED Colour: White Material: Nickel plated brass
181633	Indicator Light	Std pkg 5		
		Voltage: 12	Mount. hole size: 8 mm	Type/terminal: Solder Bulb type: LED Colour: Red Material: Nickel plated brass
181634	Indicator Light	Std pkg 5		
		Voltage: 12	Mount. hole size: 8 mm	Type/terminal: Solder Bulb type: LED Colour: Green Material: Nickel plated brass
181635	Indicator Light	Std pkg 5		
		Voltage: 12	Mount. hole size: 8 mm	Type/terminal: Solder Bulb type: LED Colour: Yellow Material: Nickel plated brass
181636	Indicator Light	Std pkg 5		
		Voltage: 12	Mount. hole size: 8 mm	Type/terminal: Solder Bulb type: LED Colour: Blue Material: Nickel plated brass Alternativ no.: 181573





181637 Indicator Light	Std pkg 5	Servicing: Beijing Benz (BBDC), Mercedes-Benz - Visit our web catalogue for further information		
		Voltage: 12	Mount. hole size: 8 mm	Type/terminal: Solder Bulb type: LED Colour: White Material: Nickel plated brass

CIRCUIT BREAKERS

ATO BLADE FUSE TYPE

	HC-CARGO	Std pkg	Ampere	Voltage	Type		
		192936	Pkg. 1	5	0-28	ATO	Manual reset.
		192937	Pkg. 1	7.5	0-28	ATO	Manual reset.
		192938	Pkg. 1	10	0-28	ATO	Manual reset.
		192939	Pkg. 1	15	0-28	ATO	Manual reset.
		192940	Pkg. 1	20	0-28	ATO	Manual reset.
		192941	Pkg. 1	25	0-28	ATO	Manual reset.

PANEL MOUNT TYPE

192959 Circuit Breaker	Std pkg 1	Servicing: Motors, transformers, battery chargers, machinery, extra low voltage systems - Visit our web catalogue for further information		
<i>Circuit breaker w/ thread neck for panel mounting. Mounting hole 9.6 mm. Splash Proof Cover: HC-CARGO 192965.</i>				
	Voltage: Multi Amp: 5	Length: 79.4 mm	Type: Thermo contact Plug type: Flat	
192960 Circuit Breaker	Std pkg 1	Servicing: Motors, transformers, battery chargers, machinery, extra low voltage systems - Visit our web catalogue for further information		
<i>Circuit breaker w/ thread neck for panel mounting. Mounting hole 9.6 mm. Splash Proof Cover: HC-CARGO 192965.</i>				
	Voltage: Multi Amp: 7	Length: 79.4 mm	Type: Thermo contact Plug type: Flat	
192961 Circuit Breaker	Std pkg 1	Servicing: Motors, transformers, battery chargers, machinery, extra low voltage systems - Visit our web catalogue for further information		
<i>Circuit breaker w/ thread neck for panel mounting. Mounting hole 9.6 mm. Splash Proof Cover: HC-CARGO 192965.</i>				
	Voltage: Multi Amp: 10	Length: 79.4 mm	Type: Thermo contact Plug type: Flat	
192962 Circuit Breaker	Std pkg 1	Servicing: Motors, transformers, battery chargers, machinery, extra low voltage systems - Visit our web catalogue for further information		
<i>Circuit breaker w/ thread neck for panel mounting. Mounting hole 9.6 mm. Splash Proof Cover: HC-CARGO 192965.</i>				
	Voltage: Multi Amp: 15	Length: 79.4 mm	Type: Thermo contact Plug type: Flat	

192963 Circuit Breaker

Std pkg 1

Servicing: Motors, transformers, battery chargers, machinery, extra low voltage systems - Visit our web catalogue for further information

Circuit breaker w/ thread neck for panel mounting. Mounting hole 9.6 mm. Splash Proof Cover: HC-CARGO 192965.



Voltage: Multi
Amp: 20

Length: 79.4 mm

Type: Thermo contact
Plug type: Flat

192964 Circuit Breaker

Std pkg 1

Servicing: Motors, transformers, battery chargers, machinery, extra low voltage systems - Visit our web catalogue for further information

Circuit breaker w/ thread neck for panel mounting. Mounting hole 9.6 mm. Splash Proof Cover: HC-CARGO 192965.



Voltage: Multi
Amp: 25

Length: 79.4 mm

Type: Thermo contact
Plug type: Flat

ACCESSORIES

192965 Splash Proof Cover

Std pkg 1

Servicing: HC-CARGO 192959..192964



RELAYS

DAYTIME RUNNING LIGHTS

160278 Relay

Std pkg 1

Servicing: HC-CARGO 160274

To be used on vehicles w/ alternator w/o diodetrio.

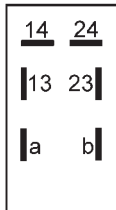

Voltage: 12

Terminals: 6

160904 Relay

Std pkg 1

Servicing: Opel, Vauxhall - Visit our web catalogue for further information

For day time running light.



Voltage: 12

Terminals: 8

ACOUSTIC WARNING

160276 Warning Relay

Std pkg 1









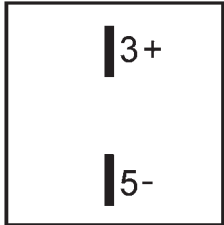

Servicing: Nissan - Visit our web catalogue for further information

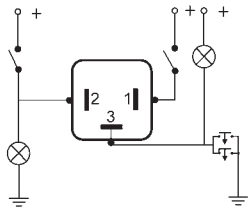

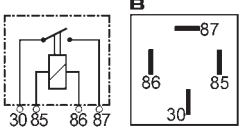

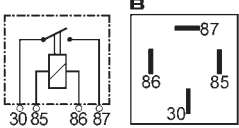

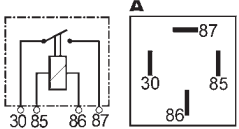

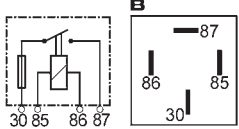

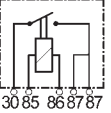
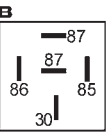

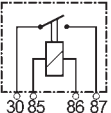
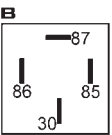
Light's on warning.

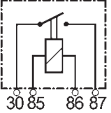
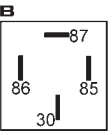

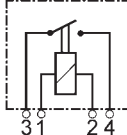

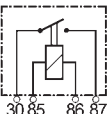
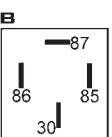

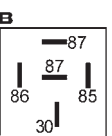

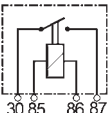
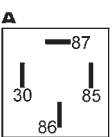

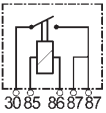
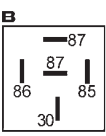

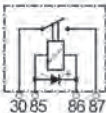
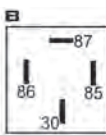

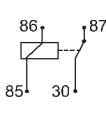
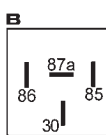
Voltage: 12
Decibel: 85

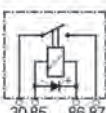
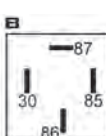
Terminals: 2

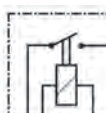
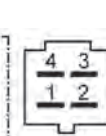
		EL. SPECIFICATIONS	DIMENSIONS	ADDITIONAL SPECIFICATIONS
160347 Warning Relay Std pkg 1		 	Voltage: 12 Decibel: 72	Type: Electronic Terminals: 2
160509 Warning Relay Std pkg 1		 	Voltage: 12 Decibel: Min 65	Type: Electronic Terminals: 3
WORK RELAYS				
MINI - 6 V				
160652 Mini Relay Std pkg 1		 	Voltage: 6 Amp: 20	Terminals: 4 Bracket: w/
MINI - 12 V				
160080 Mini Relay Std pkg 1		 	Voltage: 12 Amp: 30	Terminals: 4 Bracket: w/ Alternativ no.: 160803
160083 Mini Relay Std pkg 1		 	Voltage: 12 Amp: 30	Servicing: BMW - Visit our web catalogue for further information Terminals: 4 Bracket: w/ Alternativ no.: 160806
160155 Mini Relay Std pkg 1		 	Voltage: 12 Amp: 30	Type/fuse: ATO Terminals: 4 Bracket: w/ Fuse incl.: Yes

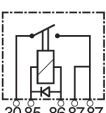
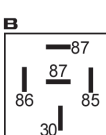
160265 Mini Relay		Std pkg 1	EL. SPECIFICATIONS	DIMENSIONS	ADDITIONAL SPECIFICATIONS
			Voltage: 12 Amp: 30		Terminals: 5 Bracket: w/ Alternativ no.: 160805
160282 Mini Relay		Std pkg 1	Voltage: 12 Amp: 40		Terminals: 4
					
160311 Mini Relay		Std pkg 1	Voltage: 12 Amp: 40		Terminals: 4 Bracket: w/
					
160480 Mini Relay		Std pkg 1	Voltage: 12 Amp: 30		Terminals: 4 Bracket: w/
<i>Relay Multiplug: HC-CARGO 193373.</i>					
					
160803 Mini Relay		Std pkg 1	Voltage: 12 Amp: 30		Terminals: 4 Bracket: w/ Alternativ no.: 160080
					
160805 Mini Relay		Std pkg 1	Voltage: 12 Amp: 30		Terminals: 5 Bracket: w/ Alternativ no.: 160265
					
160806 Mini Relay		Std pkg 1	Voltage: 12 Amp: 30		Terminals: 4 Bracket: w/ Alternativ no.: 160083
					

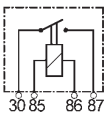
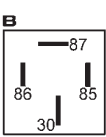
		EL. SPECIFICATIONS	DIMENSIONS	ADDITIONAL SPECIFICATIONS
160903 Mini Relay Std pkg 1		  	Voltage: 12 Amp: 40	Terminals: 5 Bracket: w/
160929 Mini Relay Std pkg 1		  	Voltage: 12 Amp: 40	Terminals: 4 Bracket: w/ Diode: w/
160945 Mini Relay Std pkg 1		  	Voltage: 12 Amp: 20	Terminals: 4 Bracket: w/
160982 Mini Relay Std pkg 1		  	Voltage: 12 Amp: 40	Terminals: 4 Bracket: w/ Diode: w/
160983 Mini Relay Std pkg 1 Relay Multiplug: HC-CARGO 193373.		  	Voltage: 12 Amp: 30	Type: Japanese Terminals: 4 Bracket: w/
161009 Mini Relay Std pkg 1		  	Voltage: 12 Amp: 40	Terminals: 5 Bracket: w/ Diode: w/
MINI - 12 V HIGH PERFORMANCE				
160239 Mini Relay Std pkg 1 w/ two 6.3 mm and two 9.5 mm terminals. (terminals 30 and 87).		  	Voltage: 12 Amp: 70	Type: High performance Terminals: 4 Bracket: w/ Alternativ no.: 160809

160468 Mini Relay Std pkg 1

w/ two 6.3 mm and two 9.5 mm terminals. (terminals 30 and 87).

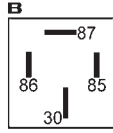
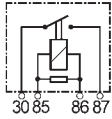
 Voltage: 12
Amp: 70

 Type: High performance
Terminals: 4
Resistor: w/

160477 Mini Relay Std pkg 1

w/ 2x6.3 mm screws and 2xM6 flat plugs.

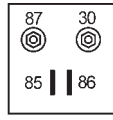
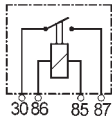
 Voltage: 12
Amp: 100

 Type: High performance
Terminals: 4
Bracket: w/
Alternativ no.: 160477z

160720 Mini Relay Std pkg 1

180 A for 15 sec. w/ 2x6.3 mm screws and 2xM6 flat plugs.

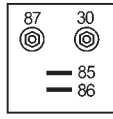
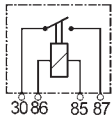
 Voltage: 12
Amp: 120

 Type: High performance
Terminals: 4
Bracket: w/

160809 Mini Relay Std pkg 1

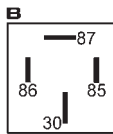
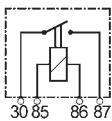
WEHRLE

 Voltage: 12
Amp: 70

 Type: High performance
Terminals: 4
Bracket: w/
Alternativ no.: 160239

160922 Mini Relay Std pkg 1

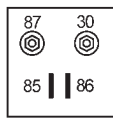
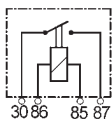
w/ 2x6.3 mm screws and 2xM6 flat plugs.

 Voltage: 12
Amp: 140

 Type: High performance
Terminals: 4
Bracket: w/

160923 Mini Relay Std pkg 1

w/ 2x6.3 mm screws and 2xM6 flat plugs.

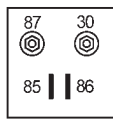
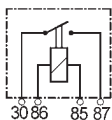
 Voltage: 12
Amp: 200

 Type: High performance
Terminals: 4
Bracket: w/

160931 Mini Relay Std pkg 1

Terminal 85+86=6.3 mm. Terminal 87+30=8 mm.

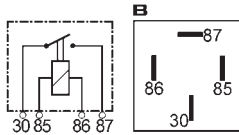
 Voltage: 12
Amp: 50

 Type: High performance
Terminals: 4
Bracket: w/

160940 Mini Relay Std pkg 1

w/ double output.

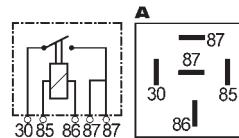
 Voltage: 12
Amp: 40

 Type: High performance
Terminals: 5
Bracket: w/

160941 Mini Relay Std pkg 1

w/ two 6.3 mm and two 9.5 mm terminals. (Terminals 30 and 87).

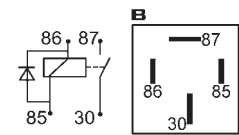
 Voltage: 12
Amp: 70

 Type: High performance
Terminals: 4
Bracket: w/
Diode: w/

160946 Mini Relay Std pkg 1

w/ two 6.3 mm and two 9.5 mm terminals. (Terminals 30 and 87).

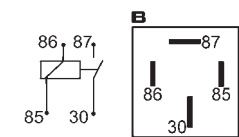
 Voltage: 12
Amp: 100



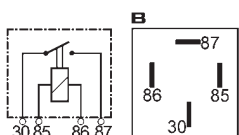



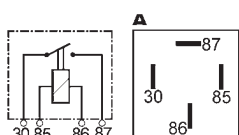



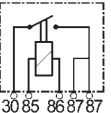
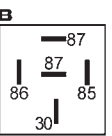

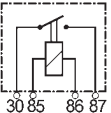
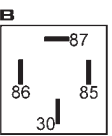
 Type: High performance
Terminals: 4

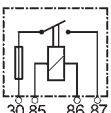
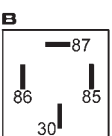

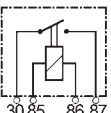
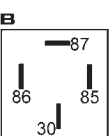

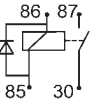
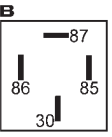

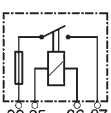
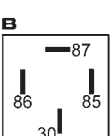

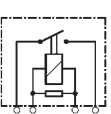
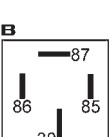

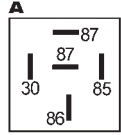

MINI - 24 V
160082 Mini Relay Std pkg 1

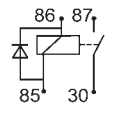
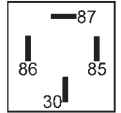
 Voltage: 24
Amp: 20

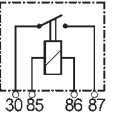
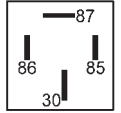
 Terminals: 4
Bracket: w/
Alternativ no.: 160307, 160807

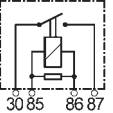
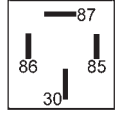
160215 Mini Relay Std pkg 1

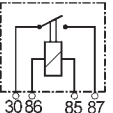
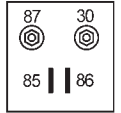
 Voltage: 24
Amp: 20

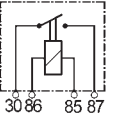
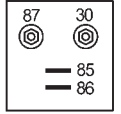
Terminals: 4

		EL. SPECIFICATIONS	DIMENSIONS	ADDITIONAL SPECIFICATIONS
160266	Mini Relay	Std pkg 1	Voltage: 24 Amp: 20	Terminals: 5 Bracket: w/
  				
160307	Mini Relay	Std pkg 1	Voltage: 24 Amp: 20	Terminals: 4
  				
160473	Mini Relay	Std pkg 1	Voltage: 24 Amp: 30	Type/fuse: ATO Terminals: 4 Bracket: w/ Fuse incl.: Yes
  				
160807	Mini Relay	Std pkg 1	Voltage: 24 Amp: 20	Terminals: 4 Bracket: w/ Alternativ no.: 160082
  				
160890	Mini Relay	Std pkg 1	Voltage: 24 Amp: 20	Terminals: 4 Bracket: w/ Diode: w/
  				
160926	Mini Relay	Std pkg 1	Voltage: 24 Amp: 15	Type/fuse: ATO Terminals: 4 Bracket: w/ Fuse incl.: Yes
  				
160935	Mini Relay	Std pkg 1	Voltage: 24 Amp: 22	Terminals: 4 Bracket: w/ Resistor: w/
  				

		EL. SPECIFICATIONS	DIMENSIONS	ADDITIONAL SPECIFICATIONS
160936 Mini Relay Std pkg 1				
<i>w/ double output.</i>				
  	Voltage: 24 Amp: 22		Terminals: 5 Bracket: w/	
160947 Mini Relay Std pkg 1				
  	Voltage: 24 Amp: 30		Terminals: 4 Bracket: w/ Diode: w/	
MINI - 24 V HIGH PERFORMANCE				
160240 Mini Relay Std pkg 1				
<i>w/ two 6.3 mm and two 9.5 mm terminals. (terminals 30 and 87).</i>				
  	Voltage: 24 Amp: 40		Type: High performance Terminals: 4	
160272 Mini Relay Std pkg 1				
<i>w/ two 6.3 mm and two 9.5 mm terminals. (terminals 30 and 87).</i>				
  	Voltage: 24 Amp: 70		Type: High performance Terminals: 4 Resistor: w/	
160478 Mini Relay Std pkg 1				
<i>180 A for 15 sec. w/ 2x6.3 mm screws and 2xM6 flat plugs.</i>				
  	Voltage: 24 Amp: 60		Type: High performance Terminals: 4 Bracket: w/	
160721 Mini Relay Std pkg 1				
  	Voltage: 24 Amp: 100		Type: High performance Terminals: 4 Bracket: w/	

160769 Mini Relay

Std pkg 1

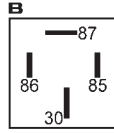
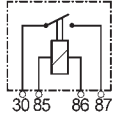
w/ two 6.3 mm and two 9.5 mm terminals. (terminals 30 and 87).

 Voltage: 24
Amp: 70

 Type: High performance
Terminals: 4

160937 Mini Relay

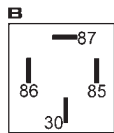
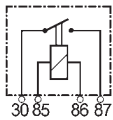
Std pkg 1

 Voltage: 24
Amp: 40

 Type: High performance
Terminals: 4
Bracket: w/

160975 Mini Relay

Std pkg 1

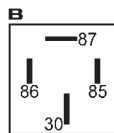
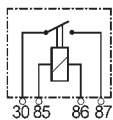
w/ two 6.3 mm and two 9.5 mm terminals. (terminals 30 and 87).

 Voltage: 24
Amp: 70

 Type: High performance
Terminals: 4
Bracket: w/

160977 Mini Relay

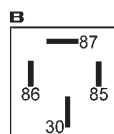
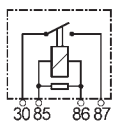
Std pkg 1

w/ two 6.3 mm and two 9.5 mm terminals. (terminals 30 and 87).

 Voltage: 24
Amp: 50

 Type: High performance
Terminals: 4
Bracket: w/
Resistor: w/

160978 Mini Relay

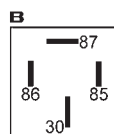
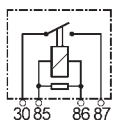
Std pkg 1

w/ two 6.3 mm and two 9.5 mm terminals. (terminals 30 and 87).

 Voltage: 24
Amp: 40

 Type: High performance
Terminals: 4
Resistor: w/

160979 Mini Relay

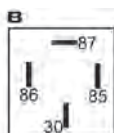
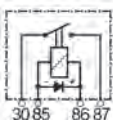
Std pkg 1



 Voltage: 24
Amp: 30

 Type: High performance
Terminals: 4
Bracket: w/
Diode: w/

161035 Mini Relay

Std pkg 1

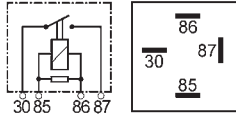
Servicing: Scania - Visit our web catalogue for further information



Voltage: 24
Amp: 70

Type: High performance
Terminals: 4
Bracket: w/
Resistor: w/

MICRO

160363 Micro Relay

Std pkg 1

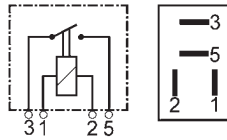

Voltage: 12
Amp: 25

Terminals: 4
Alternativ no.: 160812

160364 Micro Relay

Std pkg 1

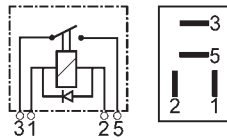

Voltage: 12
Amp: 25

Terminals: 4
Diode: w/

160812 Micro Relay

Std pkg 1

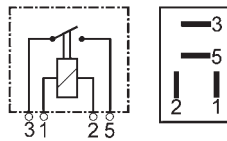

Voltage: 12
Amp: 25

Terminals: 4
Alternativ no.: 160363

160918 Micro Relay

Std pkg 1

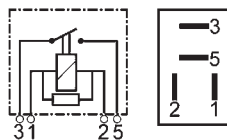

Voltage: 12
Amp: 25

Terminals: 4
Resistor: w/

DOUBLE CONTACT

160168 Relay





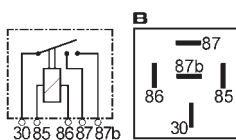





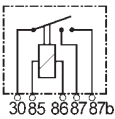
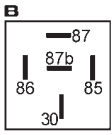

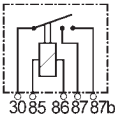
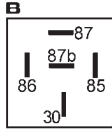
Std pkg 1

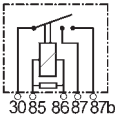
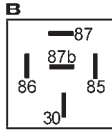
Servicing: Mercedes-Benz - Visit our web catalogue for further information

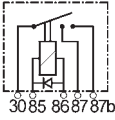
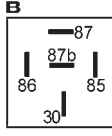

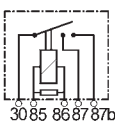
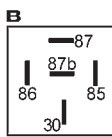
Voltage: 12
Amp: 2x20

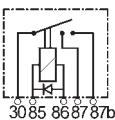
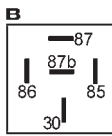
Terminals: 5
Bracket: w/

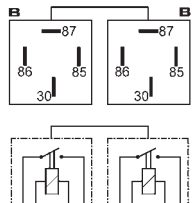
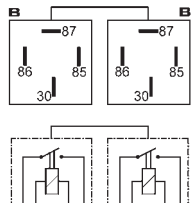
160169 Relay		Std pkg 1	EL. SPECIFICATIONS	DIMENSIONS	ADDITIONAL SPECIFICATIONS
			Voltage: 24 Amp: 2x10		Terminals: 5 Bracket: w/
160902 Relay		Std pkg 1	Voltage: 12 Amp: 2x15		Terminals: 5 Bracket: w/
					
160933 Mini Relay		Std pkg 1	Voltage: 12 Amp: 2x20		Terminals: 5 Bracket: w/ Resistor: w/
					
160934 Mini Relay		Std pkg 1	Voltage: 12 Amp: 2x20		Terminals: 5 Bracket: w/ Diode: w/
					
160938 Relay		Std pkg 1	Voltage: 24 Amp: 2x10		Terminals: 5 Bracket: w/ Resistor: w/
<i>w/ double contact.</i>					
					
160939 Relay		Std pkg 1	Voltage: 24 Amp: 2x10		Terminals: 5 Bracket: w/ Diode: w/
					
TWIN					
160267 Twin Relay		Std pkg 1	Servicing: VW - Visit our web catalogue for further information		Terminals: 2x4 Bracket: w/
			Voltage: 12 Amp: 2x40		

HIGH PERFORMANCE 12 V
160984 Relay Std pkg 1

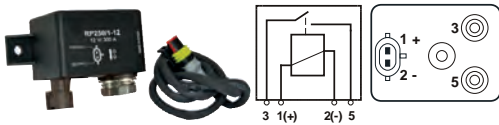
ADR-approved.

 Voltage: 12
Amp: 300

 Type: High performance
Terminals: 3
Bracket: w/

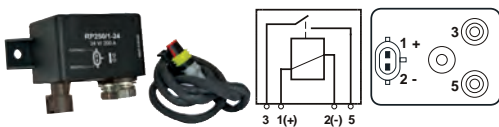
HIGH PERFORMANCE 24 V
160985 Relay Std pkg 1

ADR-approved.

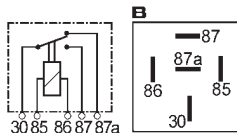
 Voltage: 24
Amp: 200

 Type: High performance
Terminals: 3
Bracket: w/

CHANGE OVER - 12 V
160081 Relay Std pkg 1

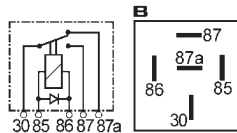
 Voltage: 12
Amp: 20/30

 Type: Change Over
Terminals: 5
Bracket: w/
Alternativ no.: 160804

160270 Relay Std pkg 1

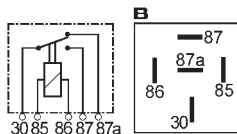
 Voltage: 12
Amp: 20/30





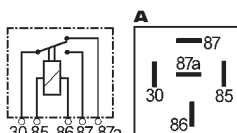





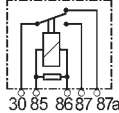
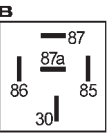

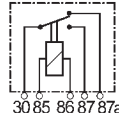
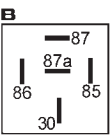

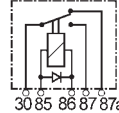
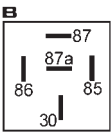
 Type: Change Over
Terminals: 5
Bracket: w/
Diode: w/
Alternativ no.: 160823

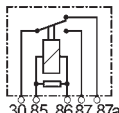
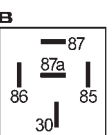

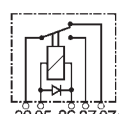
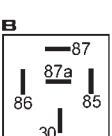

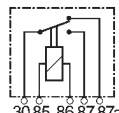
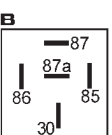

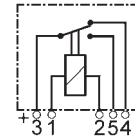



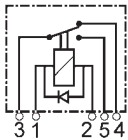

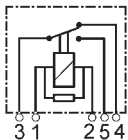
160308 Relay Std pkg 1

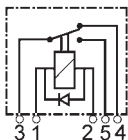
 Voltage: 12
Amp: 40/15

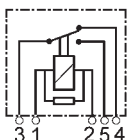

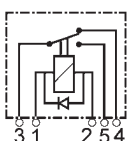

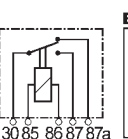
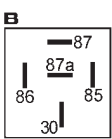

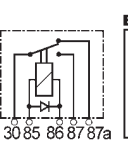
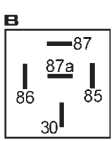



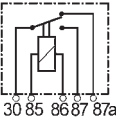
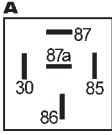

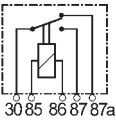
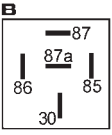
 Type: Change Over
Terminals: 5

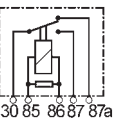
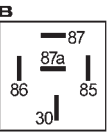
160316 Relay Std pkg 1

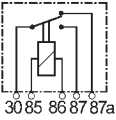
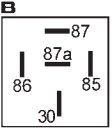
 Voltage: 12
Amp: 15/40

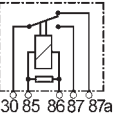
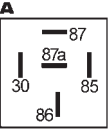
 Type: Change Over
Terminals: 5
Bracket: w/

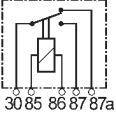
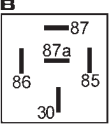
160403 Relay		Std pkg 1	EL. SPECIFICATIONS	DIMENSIONS	ADDITIONAL SPECIFICATIONS
			Voltage: 12 Amp: 20/30		Type: Change Over Terminals: 5 Bracket: w/ Resistor: w/ Alternativ no.: 160932
160804 Relay		Std pkg 1	Voltage: 12 Amp: 20/30		Type: Change Over Terminals: 5 Bracket: w/ Alternativ no.: 160081
					
160823 Relay		Std pkg 1	Voltage: 12 Amp: 20/30		Type: Change Over Terminals: 5 Bracket: w/ Diode: w/ Alternativ no.: 160270
					
160932 Relay		Std pkg 1	Voltage: 12 Amp: 40/15		Type: Change Over Terminals: 5 Bracket: w/ Resistor: w/ Alternativ no.: 160403
					
160942 Relay		Std pkg 1	Voltage: 12 Amp: 40/15		Type: Change Over Terminals: 5 Bracket: w/ Diode: w/
					
160974 Relay		Std pkg 1	Voltage: 12 Amp: 40/70		Type: Change Over Terminals: 2x6.3 mm, 3x9.5 mm Bracket: w/
					
MICRO					
160365 Micro Relay		Std pkg 1	Voltage: 12 Amp: 10/20	Servicing: Mercedes-Benz - Visit our web catalogue for further information	Type: Change Over Terminals: 5
					

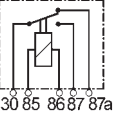
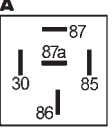
160366 Micro Relay		Std pkg 1			
			Voltage: 12 Amp: 15/25		Type: Change Over Terminals: 5 Diode: w/ Alternativ no.: 160802
160367 Micro Relay		Std pkg 1			
			Voltage: 12 Amp: 15/25		Type: Change Over Terminals: 5 Resistor: w/
160802 Micro Relay		Std pkg 1			
			Voltage: 12 Amp: 15/25		Type: Change Over Terminals: 5 Diode: w/ Alternativ no.: 160366
160919 Micro Relay		Std pkg 1	Servicing: Opel - Visit our web catalogue for further information		
			Voltage: 12 Amp: 20/10		Terminals: 5 Resistor: w/
160920 Micro Relay		Std pkg 1			
			Voltage: 12 Amp: 20/10		Terminals: 5 Diode: w/
CHANGE OVER - 24 V					
160216 Relay		Std pkg 1			
			Voltage: 24 Amp: 10/20		Type: Change Over Terminals: 5 Bracket: w/ Alternativ no.: 160808
160271 Relay		Std pkg 1			
			Voltage: 24 Amp: 10/20		Type: Change Over Terminals: 5 Bracket: w/ Diode: w/

160317 Relay		Std pkg 1	EL. SPECIFICATIONS	DIMENSIONS	ADDITIONAL SPECIFICATIONS
			Voltage: 24 Amp: 10/22		Type: Change Over Terminals: 5 Bracket: w/
160337 Relay			Std pkg 1	Servicing: Ford, Ford USA, Honda, Jaguar, Nissan, Opel, Renault, Rover, Skoda, Volvo - Visit our web catalogue for further information	
			Voltage: 24 Amp: 10/20		Type: Change Over Terminals: 5
160394 Relay			Std pkg 1	Servicing: Mercedes, Iveco, Audi - Visit our web catalogue for further information	
			Voltage: 24 Amp: 40/60		Type: Change Over Terminals: 5 Resistor: w/
160808 Relay			Std pkg 1		
			Voltage: 24 Amp: 10/20		Type: Change Over Terminals: 5 Bracket: w/ Alternativ no.: 160216
160944 Relay			Std pkg 1		
			Voltage: 24 Amp: 10/20		Type: Change Over Terminals: 5 Resistor: w/
160976 Relay			Std pkg 1		
			Voltage: 24 Amp: 30/50		Type: Change Over Terminals: 2x6.3 mm, 3x9.5 mm
160980 Relay			Std pkg 1		
			Voltage: 24 Amp: 30/40		Type: Change Over Terminals: 2x6.3 mm, 3x9.5 mm Bracket: w/

160981 Relay Std pkg 1

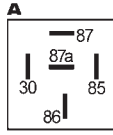
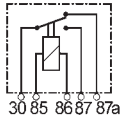

Voltage: 24
Amp: 10/20

Type: Change Over
Terminals: 5
Bracket: w/

MICRO

160368 Micro Relay Std pkg 1

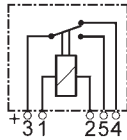

Voltage: 24
Amp: 4/10

Type: Change Over
Terminals: 5

160521 Micro Relay Std pkg 1

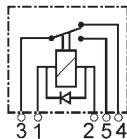

Voltage: 24
Amp: 5/10

Type: Change Over
Terminals: 5
Diode: w/

161010 Micro Relay Std pkg 1

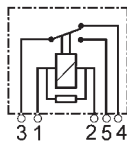

Voltage: 24
Amp: 20/10

Type: Change Over
Terminals: 5
Resistor: w/

161020 Micro Relay Std pkg 1

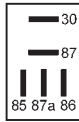
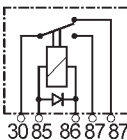

Voltage: 24
Amp: 10/15

Type: Change Over
Terminals: 5
Diode: w/

FLIP FLOP

160654 Flip Flop Relay Std pkg 1 Servicing: Audi, VW - Visit our web catalogue for further information

2 sec. on/off.

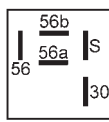
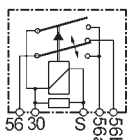

Voltage: 12
Watt: 2x150

Type: Flip Flop
Terminals: 5
Bracket: w/
Diode: w/

TIME DELAY - 12 V

160297 Time Delay Relay Std pkg 1

Servicing: Alfa Romeo, Opel, Audi, VW, Renault, Citroen, Peugeot, Volvo, Seat, Saab, Porsche, Skoda, Ford, Vauxhall, Alfa Romeo - Visit our web catalogue for further information

For windshield wiper and washer. Also for universal use.

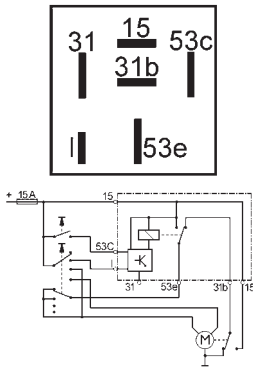

 Voltage: 12
Amp: 15

Delay time: 3.5 sec.

Terminals: 6

160570 Relay Time Delay Std pkg 1

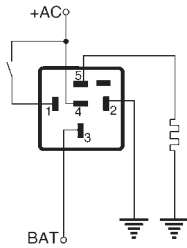
Servicing: Universal - Visit our web catalogue for further information

 Voltage: 12
Amp: 20

Delay time: 12 min.

Terminals: 5

160749 Relay Std pkg 1

Servicing: Audi, VW - Visit our web catalogue for further information

Washing/wiper unit w/ changeable intervals.

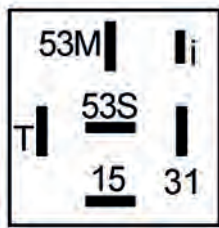
 Voltage: 12
Amp: 30

Delay time: 0.5 sec

Terminals: 6

160992 Time Delay Relay Std pkg 1

 Voltage: 12
Amp: 20

Delay time: 3.5 sec

 Type: Delay off
Terminals: 5
Bracket: w/

TIME DELAY - 24 V

160466 Time Delay Relay Std pkg 1

For A/C compressor, bus doors and time delayed motors.

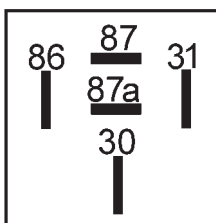

 Voltage: 24
Amp: 5

Delay time: 4 sec

Terminals: 5

MULTITIMER
160927 Multitimer Relay Std pkg 1

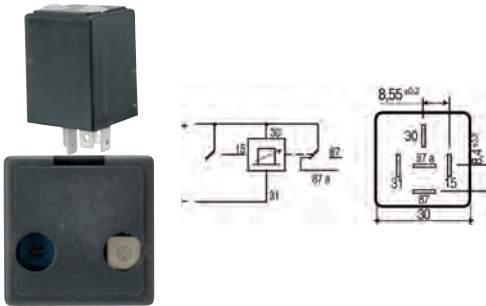
0.5 sec.-6 hours.

 Voltage: 12
Amp: 10

Terminals: 5

160928 Multitimer Relay Std pkg 1

0.5 sec.-6 hours.

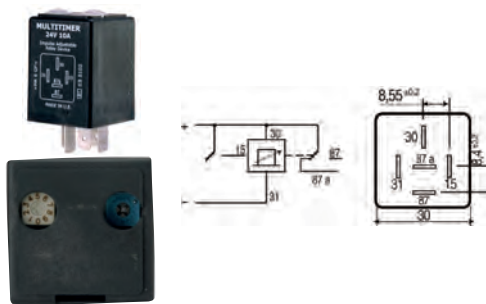
 Voltage: 24
Amp: 10

Terminals: 5

161008 Multitimer Relay Std pkg 1

0.5 sec.-10 hours.

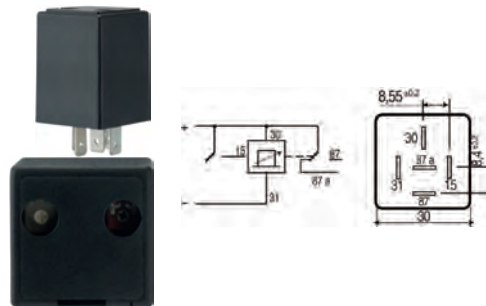
 Voltage: 12
Amp: 10

Terminals: 5

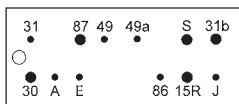
TIMING DEVICES
160287 Timing Device Std pkg 1

 Voltage: 12
Watt: 2/4x21

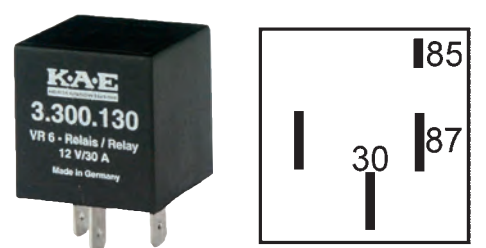
Terminals: 12

RADIATOR FANS
160637 Relay Std pkg 1

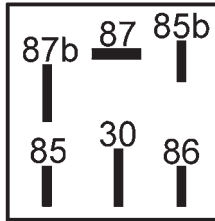
 Voltage: 12
Amp: 30

Terminals: 4

FUEL PUMPS
160295 Fuel Pump Relay Std pkg 1 Servicing: Opel, Vauxhall - Visit our web catalogue for further information

Voltage: 12

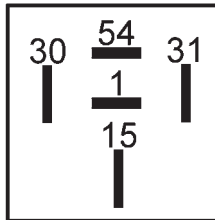
Terminals: 6

160350 Fuel Pump Relay Std pkg 1 Servicing: Ford - Visit our web catalogue for further information

 Voltage: 12
Amp: 16

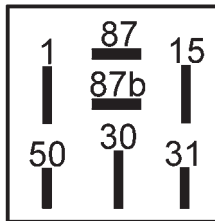
 Terminals: 5
Bracket: w/

160352 Fuel Pump Relay Std pkg 1 Servicing: BMW, Opel, Vauxhall, VW - Visit our web catalogue for further information

Voltage: 12

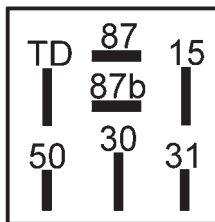
 Terminals: 7
Bracket: w/

160353 Fuel Pump Relay Std pkg 1 Servicing: Alfa Romeo, Citroen, Ferrari, Fiat, Ford, Lancia, Peugeot, Seat - Visit our web catalogue for further information

 Voltage: 12
Amp: 16

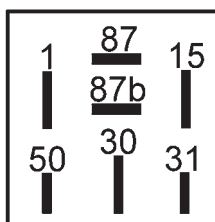
 Terminals: 7
Bracket: w/



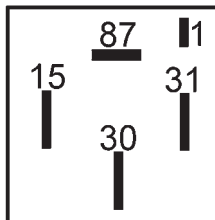







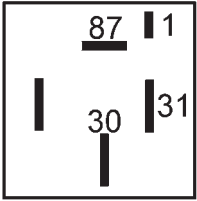

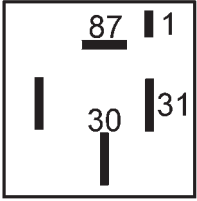
160354 Fuel Pump Relay Std pkg 1 Servicing: Alfa Romeo, Citroen, Fiat, Lancia, Opel, Peugeot, Renault, Vauxhall - Visit our web catalogue for further information

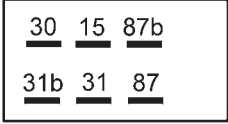
 Voltage: 12
Amp: 16

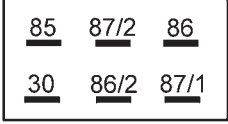
 Terminals: 7
Bracket: w/

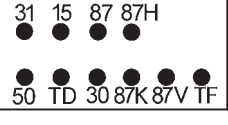
160372 Fuel Pump Relay Std pkg 1 Servicing: Audi - Visit our web catalogue for further information

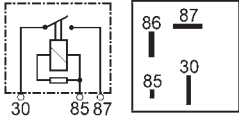
Voltage: 12

Terminals: 5

		EL. SPECIFICATIONS	DIMENSIONS	ADDITIONAL SPECIFICATIONS
160374	Fuel Pump Relay	Std pkg 1	Servicing: Audi, VW - Visit our web catalogue for further information	
		Voltage: 12	RPM limited: 6600	Terminals: 5
160375	Fuel Pump Relay	Std pkg 1	Servicing: Audi, VW - Visit our web catalogue for further information	
		Voltage: 12	RPM limited: 6600	Terminals: 5
160400	Fuel Pump Relay	Std pkg 1	Servicing: Volvo - Visit our web catalogue for further information	
		Voltage: 12 Amp: 30		Terminals: 6
160401	Fuel Pump Relay	Std pkg 1	Servicing: Volvo - Visit our web catalogue for further information	
		Voltage: 12 Amp: 15		Terminals: 6
160470	Fuel Pump Relay	Std pkg 1	Servicing: Mercedes-Benz - Visit our web catalogue for further information	
<i>Cold start valve.</i>				
		Voltage: 12	RPM limited: 6200	Terminals: 10
160751	Fuel Pump Relay	Std pkg 1	Servicing: Audi, Seat, Skoda, VW - Visit our web catalogue for further information	
		Voltage: 12 Amp: 30		Terminals: 4 Resistor: w/
160792	Fuel Pump Relay	Std pkg 1	Servicing: Volvo - Visit our web catalogue for further information	
		Voltage: 12		Terminals: 4

161121 Fuel Pump Relay Std pkg 1 Servicing: Audi - Visit our web catalogue for further information

w/ two 6.3 mm and two 2.8 mm terminals. (terminals 86 and 85).

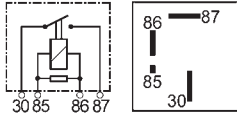

Voltage: 12
Amp: 40

Terminals: 4
Bracket: w/o

HAZARD WARNING LIGHT SYSTEM

160578 Hazard Warning Light Std pkg 1

Complete set containing switch, relay and mounting bracket.



Voltage: 12

FLASHER UNITS - 6 V

160651 Flasher Unit Std pkg 1

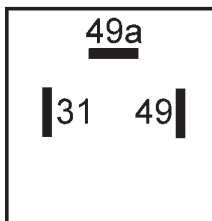

Voltage: 6
Watt: 42

Terminals: 3
Bracket: w/

FLASHER UNITS - 12 V

160115 Flasher Unit Std pkg 1

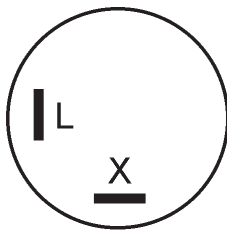

Voltage: 12
Watt: 138

Terminals: 2

160116 Flasher Unit Std pkg 1

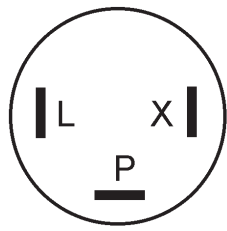

Voltage: 12
Watt: 138





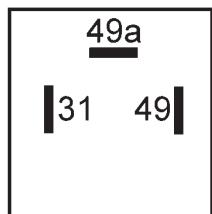



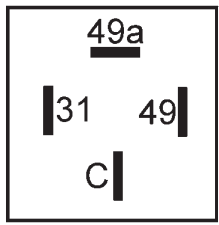

Terminals: 3

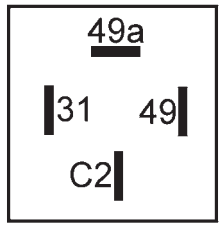

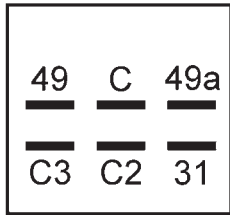

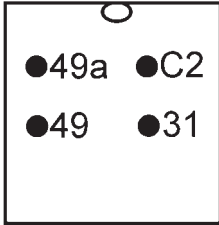

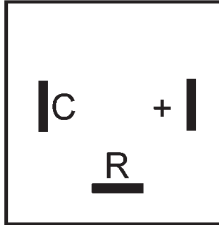

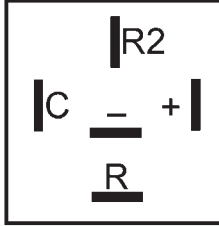

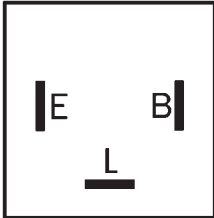
160242 Flasher Unit Std pkg 1 Servicing: Alfa Romeo, Audi, Bedford, Ford, Nissan, Opel, Toyota - Visit our web catalogue for further information

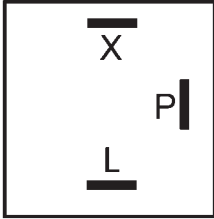

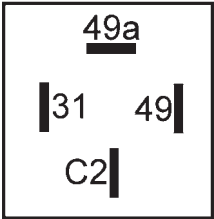

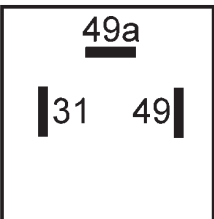



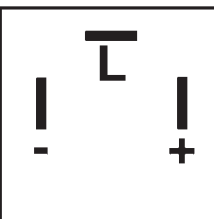

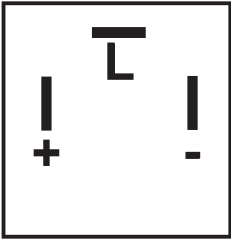
Voltage: 12
Watt: 2/4x21

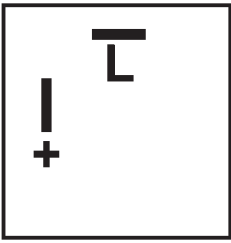
Terminals: 3
Bracket: w/

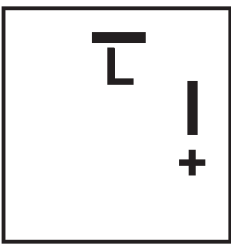
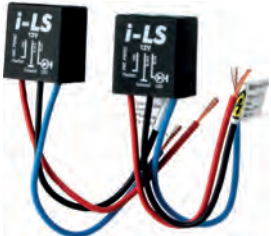
		EL. SPECIFICATIONS	DIMENSIONS	ADDITIONAL SPECIFICATIONS
160243 Flasher Unit Std pkg 1		Servicing: Abarth, Alfa Romeo, Audi, Austin, BMW, Citroen, Fiat, Ford, Honda, Iveco, Lada, Lancia, Mercedes-Benz, Opel, Peugeot - Visit our web catalogue for further information		
		Voltage: 12 Watt: 2/4x21		Terminals: 4 Bracket: w/
160244 Flasher Unit Std pkg 1		Servicing: Audi, Austin, BMW, Chevrolet, Citroen, Daihatsu, Fiat, Ford, Ford Australia, Honda, Lada, Lancia, Land Rover, Lexus - Visit our web catalogue for further information		
<i>For vehicles w/ towbars.</i>				
		Voltage: 12 Watt: 2+1/6x21		Terminals: 4 Bracket: w/
160263 Flasher Unit Std pkg 1		Servicing: Steyr - Visit our web catalogue for further information		
		Voltage: 12 Watt: 2+1+1/8x21		Terminals: 6 Bracket: w/
160305 Flasher Unit Std pkg 1		Servicing: Mercedes-Benz - Visit our web catalogue for further information		
<i>For vehicles w/ towbars.</i>				
		Voltage: 12 Watt: 2+1/6x21		Terminals: 4
160312 Flasher Unit Std pkg 1		Interchangeable w/ all 4 terminal device (+, -, C, R). for SAE standard vehicles (France, Italy, USA, Spain).		
		Voltage: 12 Watt: 2/4x21		Terminals: 3 Bracket: w/
160314 Flasher Unit Std pkg 1		Servicing: Alfa Romero, Renault, Fiat, Lancia, Lada, Alfa Romeo, BMW, Fiat, Lada, Lancia, Renault - Visit our web catalogue for further information		
<i>For vehicles w/ towbars. For SAE standard vehicles (France, Italy, USA, Spain).</i>				
		Voltage: 12 Watt: 2+1/6x21		Terminals: 5 Bracket: w/

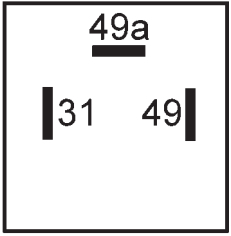
		EL. SPECIFICATIONS	DIMENSIONS	ADDITIONAL SPECIFICATIONS
160315 Flasher Unit Std pkg 1		Servicing: Japanese vehicles - Visit our web catalogue for further information		
		Voltage: 12 Watt: 2/4x21		Terminals: 3
160341 Flasher Unit Std pkg 1		Servicing: Abarth, Alfa Romeo, Audi, Austin, BMW, Citroen, Fiat, Ford, Honda, Lada, Mercedes-Benz, Opel, Peugeot, Porsche - Visit our web catalogue for further information		
		Voltage: 12 Amp: 16 Watt: 180		Terminals: 3 Bracket: w/
160402 Flasher Unit Std pkg 1		For vehicles w/ towbars.		
		Voltage: 12 Watt: 2+1/6x21		Terminals: 4+2/top
160474 Flasher Unit Std pkg 1				
		Voltage: 12 Watt: 2/4x21		Terminals: 3
160475 Flasher Unit Std pkg 1		For vehicles w/ towbars.		
		Voltage: 12 Watt: 2+1/6x21		Terminals: 3+2/top
W/ LED				
160948 Flasher Unit Std pkg 1				
		Voltage: 12 Watt: 0.1-150	Height: 30 mm	Terminals: 3

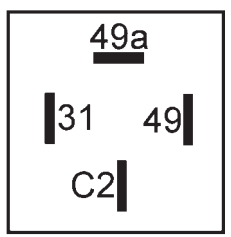
		EL. SPECIFICATIONS	DIMENSIONS	ADDITIONAL SPECIFICATIONS
160949 Flasher Unit Std pkg 1				
		Voltage: 12 Watt: 0.1-150	Height: 30 mm	Terminals: 3
160950 Flasher Unit Std pkg 1				
		Voltage: 12 Watt: 0.1-150	Height: 30 mm	Terminals: 2
160951 Flasher Unit Std pkg 1				
		Voltage: 12 Watt: 0.1-150	Height: 30 mm	Terminals: 2
160954 i-LS sensor Std pkg 1				
<i>In combination w/ an I-LS flasher unit, the I-LS sensor secures the legal requirements of "lamp failure warning".</i>				
		Voltage: 12	Height: 26 mm	Terminals: 3
160956 Flasher Unit i-LS Std pkg 1		Servicing: Vehicles w/ 2 LED lamps on front or rear - Visit our web catalogue for further information		
<i>In combination w/ an I-LS sensor, the I-LS flasher relay secures the legal requirements of "lamp failure warning" by installed LED lamps.</i>				
		Voltage: 12 Watt: 90		Terminals: 3 Bracket: w/
160957 Flasher Unit i-LS Std pkg 1		Servicing: Vehicles w/ trailer, w/ 2 LED lamps - Visit our web catalogue for further information		
<i>In combination w/ an I-LS sensor, the I-LS flasher relay secures the legal requirements of "lamp failure warning" by installed LED lamps.</i>				
		Voltage: 12 Watt: 170		Terminals: 4 Bracket: w/

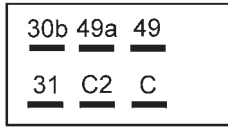
FLASHER UNITS - 24 V
160199 Flasher Unit Std pkg 1 Servicing: Mazda, Setra, Volvo - Visit our web catalogue for further information

 Voltage: 24
 Watt: 3+1/8x21

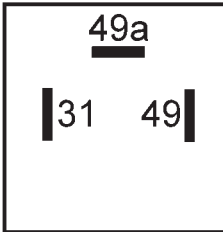
 Terminals: 6
 Bracket: w/

160261 Flasher Unit Std pkg 1 Servicing: Mercedes-Benz - Visit our web catalogue for further information

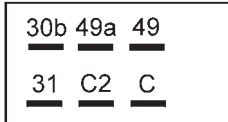
 Voltage: 24
 Watt: 2/4x21

 Terminals: 3
 Bracket: w/

160262 Flasher Unit Std pkg 1

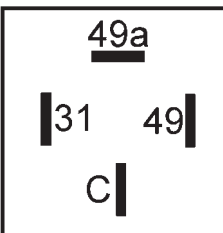
 Voltage: 24
 Watt: 2+1/6x21

 Terminals: 6
 Bracket: w/

160296 Flasher Unit Std pkg 1

 Voltage: 24
 Watt: 2/4x21

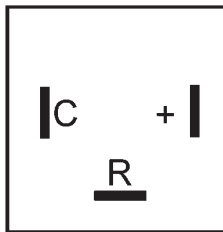
 Terminals: 4
 Bracket: w/





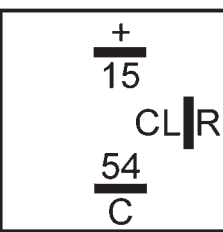

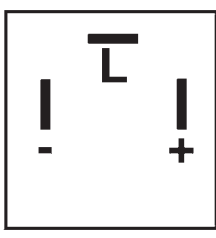

160313 Flasher Unit Std pkg 1

Interchangeable w/ all 4 terminal device (+, -, C, R). for SAE standard vehicles (France, Italy, USA, Spain).

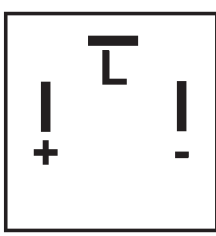
 Voltage: 24
 Watt: 2/4x21

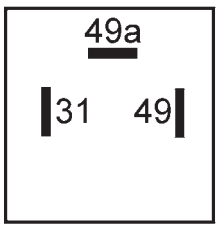

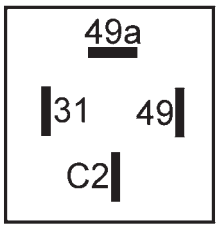
 Terminals: 3
 Bracket: w/

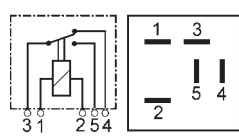





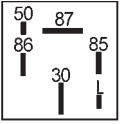
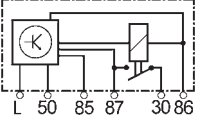
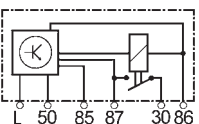

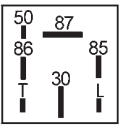
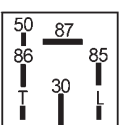

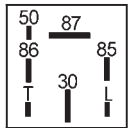
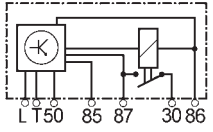
160716 Flasher Unit Std pkg 1

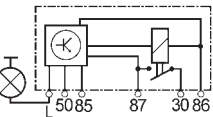
 Voltage: 24
 Watt: 500

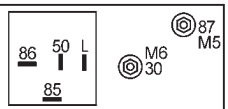
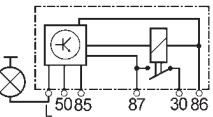

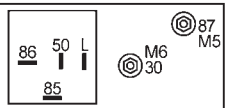
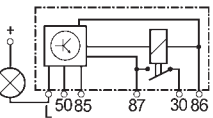

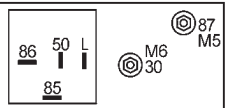
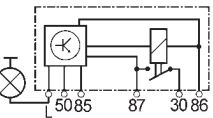

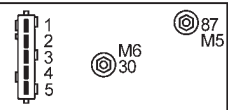
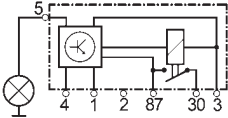

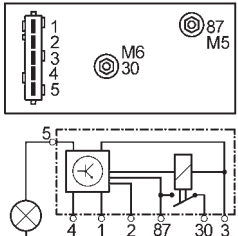

 Terminals: 3
 Bracket: w/

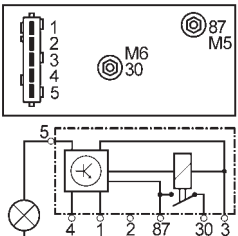

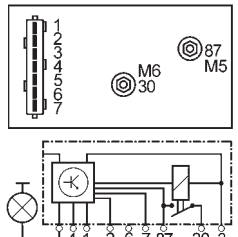

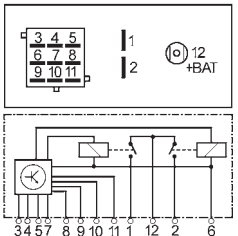

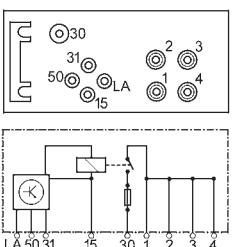

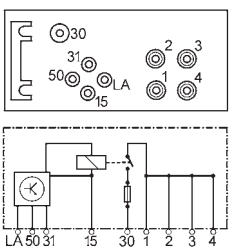

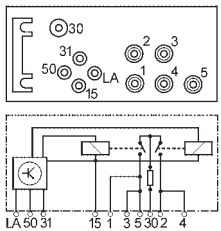
W/ LED				
160952 Flasher Unit Std pkg 1		 	Voltage: 24 Watt: 0.1-150	Height: 30 mm Terminals: 3
160953 Flasher Unit Std pkg 1		 	Voltage: 24 Watt: 0.1-150	Height: 30 mm Terminals: 3
160955 i-LS Sensor Std pkg 1		<i>In combination w/ an I-LS flasher unit, the I-LS sensor secures the legal requirements of "lamp failure warning".</i>		
		Voltage: 24	Terminals: 3	
160958 Flasher Unit i-LS Std pkg 1		Servicing: Vehicles w/ 2 LED lamps on front or rear - Visit our web catalogue for further information		
<i>In combination w/ an I-LS sensor, the I-LS flasher relay secures the legal requirements of "lamp failure warning" by installed LED lamps.</i>				
 		Voltage: 24 Watt: 90	Terminals: 3 Bracket: w/	
160959 Flasher Unit i-LS Std pkg 1		Servicing: Vehicles w/ trailer, w/ 2 LED lamps - Visit our web catalogue for further information		
<i>In combination w/ an I-LS sensor, the I-LS flasher relay secures the legal requirements of "lamp failure warning" by installed LED lamps.</i>				
 		Voltage: 24 Watt: 170	Terminals: 4 Bracket: w/	
CHARGE RELAYS				
160407 Charge Relay Std pkg 1		Servicing: Isuzu - Visit our web catalogue for further information		
5 terminals.				
 		Voltage: 14 Amp: 20		

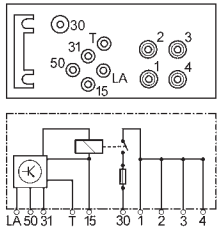

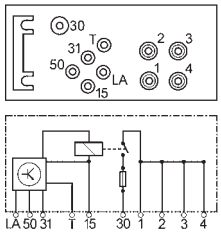

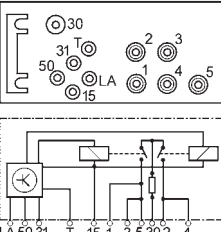

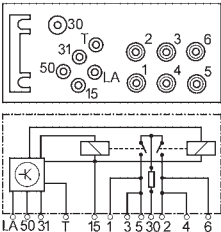

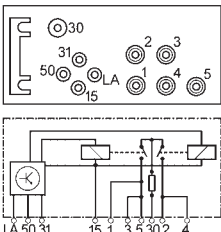
GLOW PLUG RELAYS

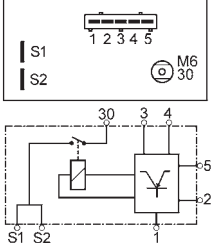
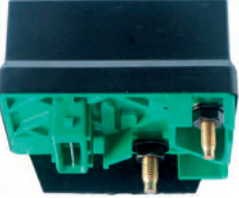
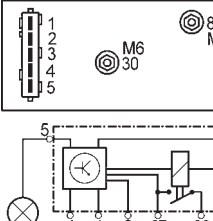

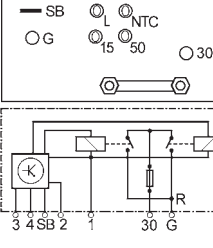

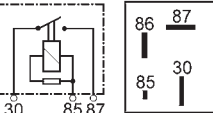

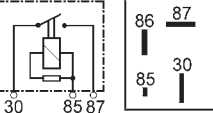

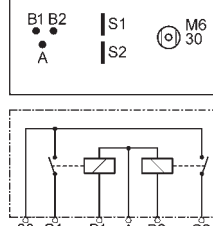
160416 Glow Plug Relay		Std pkg 1	Servicing: Ford, Opel, Vauxhall - Visit our web catalogue for further information		
		Voltage: 12 Amp: 70	Pre-heating time: < 8	Terminals: 6 Post heating: No Bracket: w/	
					
160417 Glow Plug Relay		Std pkg 1	Servicing: Ford, Opel, Vauxhall - Visit our web catalogue for further information		
		Voltage: 12 Amp: 70	Pre-heating time: < 13	Terminals: 6 Post heating: No Bracket: w/	
					
160418 Glow Plug Relay		Std pkg 1	Servicing: Ford, Opel, Vauxhall - Visit our web catalogue for further information		
		Voltage: 12 Amp: 70	Pre-heating time: < 8	Terminals: 6 Post heating: Yes Bracket: w/	
					
160419 Glow Plug Relay		Std pkg 1	Servicing: Ford, Opel, Vauxhall - Visit our web catalogue for further information		
		Voltage: 12 Amp: 70	Pre-heating time: < 6	Terminals: 6 Post heating: Yes Bracket: w/	
					
160420 Glow Plug Relay		Std pkg 1	Servicing: Audi, VW - Visit our web catalogue for further information		
		Voltage: 12	Pre-heating time: < 8	Terminals: 7 Post heating: Yes	
					
160421 Glow Plug Relay		Std pkg 1	Servicing: Audi, Seat, VW - Visit our web catalogue for further information		
		Voltage: 12	Pre-heating time: < 4	Terminals: 7 Post heating: Yes	
					

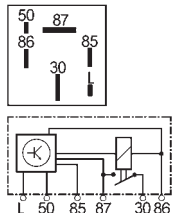
		EL. SPECIFICATIONS	DIMENSIONS	ADDITIONAL SPECIFICATIONS
160422	Glow Plug Relay	Std pkg 1	Servicing: Fiat, Seat, VW - Visit our web catalogue for further information	
	 	Voltage: 12	Pre-heating time: < 18	Terminals: 7 Post heating: No
160423	Glow Plug Relay	Std pkg 1	Servicing: Citroen, Peugeot, Renault - Visit our web catalogue for further information	
	 	Voltage: 12 Amp: 70	Pre-heating time: < 14	Terminals: 6 Post heating: No
160424	Glow Plug Relay	Std pkg 1	Servicing: Alfa Romeo, Citroen, Fiat, Iveco, Peugeot, Renault, Rover, Seat, Talbot - Visit our web catalogue for further information	
	 	Voltage: 12 Amp: 70	Pre-heating time: < 8	Terminals: 6 Post heating: No
160425	Glow Plug Relay	Std pkg 1	Servicing: Renault - Visit our web catalogue for further information	
	 	Voltage: 12 Amp: 70	Pre-heating time: < 9	Terminals: 6 Post heating: No
160426	Glow Plug Relay	Std pkg 1	Servicing: Fiat - Visit our web catalogue for further information	
	 	Voltage: 12 Amp: 70	Pre-heating time: < 7	Terminals: 6 Post heating: Yes
160431	Glow Plug Relay	Std pkg 1	Servicing: Peugeot - Visit our web catalogue for further information	
	 	Voltage: 12 Amp: 70	Pre-heating time: < 10	Terminals: 7 Post heating: No

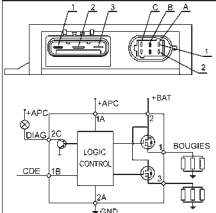
		EL. SPECIFICATIONS	DIMENSIONS	ADDITIONAL SPECIFICATIONS
160432 Glow Plug Relay Std pkg 1		Servicing: Citroen, Fiat, Peugeot, Renault, Rover - Visit our web catalogue for further information		
		Voltage: 12 Amp: 70	Pre-heating time: < 7	Terminals: 7 Post heating: Yes
160434 Glow Plug Relay Std pkg 1		Servicing: Citroen, Fiat, Peugeot - Visit our web catalogue for further information		
		Voltage: 12 Amp: 70	Pre-heating time: < 8	Terminals: 7 Post heating: Yes
160436 Glow Plug Relay Std pkg 1		Servicing: Citroen, Peugeot - Visit our web catalogue for further information		
		Voltage: 12 Amp: 70	Pre-heating time: < 8	Terminals: 9 Post heating: Yes
160438 Glow Plug Relay Std pkg 1		Servicing: Renault - Visit our web catalogue for further information		
		Voltage: 12	Pre-heating time: < 10	Terminals: 12 Post heating: Yes
160441 Glow Plug Relay Std pkg 1		Servicing: Mercedes-Benz - Visit our web catalogue for further information		
<i>w/ "defect" warning.</i>				
		Voltage: 12 Amp: 70	Pre-heating time: < 9	Terminals: 9 Post heating: No
160442 Glow Plug Relay Std pkg 1		Servicing: Mercedes-Benz - Visit our web catalogue for further information		
<i>w/ "defect" warning.</i>				
		Voltage: 12 Amp: 70	Pre-heating time: < 9	Terminals: 9 Post heating: No

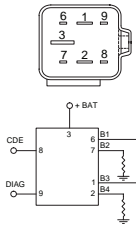
		EL. SPECIFICATIONS	DIMENSIONS	ADDITIONAL SPECIFICATIONS
160443 Glow Plug Relay Std pkg 1 Servicing: Mercedes-Benz - Visit our web catalogue for further information				
<i>w/ "defect" warning.</i>				
		Voltage: 12 Amp: 140	Pre-heating time: < 9	Terminals: 10 Post heating: No
160445 Glow Plug Relay Std pkg 1 Servicing: Mercedes-Benz - Visit our web catalogue for further information				
<i>w/ "defect" warning.</i>				
		Voltage: 12 Amp: 70	Pre-heating time: < 9	Terminals: 10 Post heating: Yes
160446 Glow Plug Relay Std pkg 1 Servicing: Mercedes-Benz - Visit our web catalogue for further information				
<i>w/ "defect" warning.</i>				
		Voltage: 12 Amp: 70	Pre-heating time: < 9	Terminals: 10 Post heating: Yes
160447 Glow Plug Relay Std pkg 1 Servicing: Audi, Mercedes-Benz - Visit our web catalogue for further information				
<i>w/ "defect" warning.</i>				
		Voltage: 12 Amp: 140	Pre-heating time: < 9	Terminals: 11 Post heating: Yes
160448 Glow Plug Relay Std pkg 1 Servicing: Mercedes-Benz, Puch (Steyr-Daimler) - Visit our web catalogue for further information				
<i>w/ "defect" warning.</i>				
		Voltage: 12 Amp: 140	Pre-heating time: < 9	Terminals: 12 Post heating: Yes
160449 Glow Plug Relay Std pkg 1 Servicing: Mercedes-Benz, Ssangyong - Visit our web catalogue for further information				
<i>Can replace HC-CARGO 160441 and 160443 in connection w/ change to post heating glow plug.</i>				
		Voltage: 12 Amp: 140	Pre-heating time: < 7	Terminals: 10 Post heating: Yes

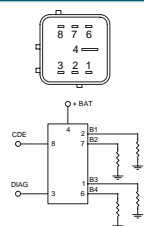
		EL. SPECIFICATIONS	DIMENSIONS	ADDITIONAL SPECIFICATIONS
160451	Glow Plug Relay	Std pkg 1	Servicing: Renault - Visit our web catalogue for further information	
		<p>Voltage: 12</p>	<p>Pre-heating time: < 7</p>	<p>Terminals: 8</p> <p>Post heating: Yes</p>
160453	Glow Plug Relay	Std pkg 1	Servicing: Audi, Citroen, Fiat, Lancia, Peugeot - Visit our web catalogue for further information	
		<p>Voltage: 12</p>		<p>Terminals: 7</p> <p>Post heating: No</p>
160458	Glow Plug Relay	Std pkg 1	Servicing: Volvo - Visit our web catalogue for further information	
		<p>Voltage: 12</p> <p>Amp: 140</p>	<p>Pre-heating time: < 12</p>	<p>Terminals: 7</p> <p>Post heating: Yes</p>
160459	Glow Plug Relay	Std pkg 1	Servicing: Seat, VW - Visit our web catalogue for further information	
<i>Model UWD.</i>				
		<p>Voltage: 12</p>		<p>Terminals: 4</p> <p>Post heating: No</p>
160460	Glow Plug Relay	Std pkg 1	Servicing: Audi, Seat, Skoda, VW - Visit our web catalogue for further information	
<i>For engines w/ electronic diesel control.</i>				
		<p>Voltage: 12</p>		<p>Terminals: 4</p> <p>Post heating: No</p>
160461	Glow Plug Relay	Std pkg 1	Servicing: Volvo - Visit our web catalogue for further information	
		<p>Voltage: 12</p>		<p>Terminals: 6</p> <p>Post heating: No</p>

		EL. SPECIFICATIONS	DIMENSIONS	ADDITIONAL SPECIFICATIONS
160469	Glow Plug Relay	Std pkg 1	Servicing: Ford - Visit our web catalogue for further information	
		Voltage: 12	Pre-heating time: < 5	Terminals: 6 Post heating: Yes Bracket: w/
160718	Glow Plug Relay	Std pkg 1	Servicing: Renault - Visit our web catalogue for further information	
		Voltage: 12		Terminals: 9 Post heating: No Bracket: w/
160719	Glow Plug Relay	Std pkg 1	Servicing: Renault - Visit our web catalogue for further information	
		Voltage: 12		Terminals: 9 Post heating: No Bracket: w/
160795	Glow Plug Relay	Std pkg 1	Servicing: Renault - Visit our web catalogue for further information	
		Voltage: 12		Terminals: 7 Post heating: No Bracket: w/
161120	Glow Plug Relay	Std pkg 1	Servicing: Citroen, Dacia, Fiat, Lancia, Nissan, Opel, Peugeot, Renault, Vauxhall - Visit our web catalogue for further information	
		Voltage: 12		Terminals: 7 Bracket: w/
161735	Glow Plug Relay	Std pkg 1	Servicing: Daihatsu, Fiat, Foden Trucks, Iveco, Mercedes-Benz, Mitsubishi, Volvo - Visit our web catalogue for further information	
		Voltage: 12		Terminals: 6
161736	Glow Plug Relay	Std pkg 1	Servicing: Opel, Saab, Vauxhall - Visit our web catalogue for further information	
		Voltage: 12		Terminals: 7

		EL. SPECIFICATIONS	DIMENSIONS	ADDITIONAL SPECIFICATIONS
161737	Glow Plug Relay	Std pkg 1	Servicing: Alfa Romeo, Citroen, Fiat, Great Wall, Jaguar, Lancia, Peugeot - Visit our web catalogue for further information	
		Voltage: 12		Terminals: 11
161738	Glow Plug Relay	Std pkg 1	Servicing: Audi, Chevrolet, Chrysler, Dodge, Jeep, Opel, Seat, Skoda, Vauxhall, VW - Visit our web catalogue for further information	
		Voltage: 12		Terminals: 8
161739	Glow Plug Relay	Std pkg 1	Servicing: Audi, Porsche, VW - Visit our web catalogue for further information	
		Voltage: 12		Terminals: 11
161740	Glow Plug Relay	Std pkg 1	Servicing: Nissan - Visit our web catalogue for further information	
		Voltage: 12		Terminals: 8
MULTI PLUGS				
190766	Relay Multiplug	Std pkg 10	Servicing: HC-CARGO 192158	
<i>Sockets can be built together. 5x6.3 mm flat plug terminals. 4x2.8 mm flat plug terminals.</i>				
				Type: Socket No./poles: 9
190767	Relay Multiplug	Std pkg 10	Servicing: HC-CARGO 192159	
<i>6.3 mm.</i>				
				Type: Socket No./poles: 5
191026	Relay Multiplug	Std pkg 10	Servicing: HC-CARGO 192160	
<i>Sockets can be built together. 2x9.5 mm flat plug terminals. 3x6.3 mm flat plug terminals. 4x2.8 mm flat plug terminals.</i>				
				Type: Socket No./poles: 9

191752 Relay Multiplug Std pkg 10 Servicing: HC-CARGO 192161

Sockets can be built together. 2x6.3 mm flat plug terminals. 3x4.7 mm flat plug terminals.



Type: Socket
No./poles: 5

193373 Relay Multiplug Std pkg 10 Servicing: HC-CARGO 160480, 160983

Terminal: HC-CARGO 192377, 190868, 193238, 192574.



Type: Socket
Colour: White
No./poles: 4
Plug: Female

193600 Relay Multiplug Std pkg 5

Sockets can be built together. 6.3 mm flat plug terminals. 2.8 mm flat plug terminals.



Type: Socket
No./poles: 5
Alternativ no.: 193734

KITS

192158 Relay Multiplug Kit Std pkg 1

Contains: 1x HC-CARGO 190766. 5x HC-CARGO 190252. 4x HC-CARGO 191083.



192159 Relay Multiplug Kit Std pkg 1

Contains: 1x HC-CARGO 190767. 5x HC-CARGO 190252.

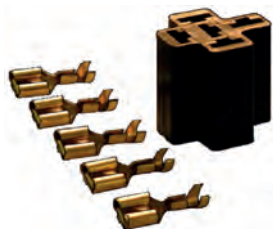

192160 Relay Multiplug Kit Std pkg 1

Contains: 1x HC-CARGO 191026. 2x HC-CARGO 191025. 3x HC-CARGO 190252. 1x HC-CARGO 191083.

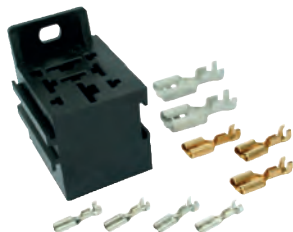

192161 Relay Multiplug Kit Std pkg 1

Contains: 1x HC-CARGO 191752. 2x HC-CARGO 190252. 3x HC-CARGO 191089.

TRAILER SWITCH BOXES
160167 Relay Box Std pkg 1 Servicing: For 12 V trailer pulled by a 24 V vehicle - Visit our web catalogue for further information

Switches the voltage from 24 V to 12 V by 5 relays. Run at 24 V and leading 12 V from one of the batteries or converter to the lamps of the trailer. For continuous use it has to be connected via a converter. For internal mounting.



Voltage: 12/24
Amp: 10
Watt: 250

Dim.: 100x100x58 mm

No./poles: 7
Relay switch: Yes

160502 Trailer Connecting Unit Std pkg 1 Servicing: For 12 V trailer pulled by a 24 V vehicle - Visit our web catalogue for further information

Mounted w/o use of converter.



Voltage: 24/12

Dim.: 110x103x43 mm

No./poles: 7
Transistor switch: Yes
Waterproof: Yes
C2 control lamp: w/
Relay switch: No
Protection degree: IP 65

160797 Relay Box Std pkg 1

To reduce voltage drop, if you use vehicles w/ trailer. Fitted w/ 5x12 V relays the 12 V function will not be affected.



Voltage: 12-12
Amp: 5x8
Watt: 5x250

Dim.: 100x100x58 mm

BOXES
191410 Relay Box Std pkg 1

Can be assembled in rows (terminals: HC-CARGO 190252 or 191029).



Capacity: 4

Regulator type: Standard
Colour: Transparent
Assembling: Yes
Terminals: w/
Lock: w/

191818 Relay Box Std pkg 1

Can be assembled in rows (terminals: HC-CARGO 190252 or 191029).



Capacity: 7

Regulator type: Micro
Colour: Transparent
Assembling: Yes
Terminals: w/
Lock: w/

POWR-BLOKS

191717 Powr-Blok Std pkg 10

The POWR-BLOKSTM system gives you unlimited flexibility to design electrical distribution systems that range from simple to complex. Choose from a variety of POWR-BLOKSTM modules that accommodate everything you need in power distribution or circuit protection blocks, including fuses, circuit breakers, relays, flashers and specialty devices. It is the totally modular way to build your own junction block. Typical Applications: Buses, Conversion Vans, Off Road and Recreational Vehicles, Construction Equipment, Emergency Vehicles, Farm Equipment, Heavy Duty Trucks, Industrial Vehicles, Marine, High Performance and Racing Vehicles. Terminals: HC-CARGO 191733, 191734, 192758.

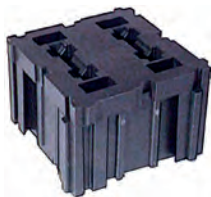

Height: 30.48 mm
Module: Fuse holder

Type/fuse: ATO
Outlets: 2 way

191718 Powr-Blok Std pkg 5

The POWR-BLOKSTM system gives you unlimited flexibility to design electrical distribution systems that range from simple to complex. Choose from a variety of POWR-BLOKSTM modules that accommodate everything you need in power distribution or circuit protection blocks, including fuses, circuit breakers, relays, flashers and specialty devices. It is the totally modular way to build your own junction block. Typical Applications: Buses, Conversion Vans, Off Road and Recreational Vehicles, Construction Equipment, Emergency Vehicles, Farm Equipment, Heavy Duty Trucks, Industrial Vehicles, Marine, High Performance and Racing Vehicles. Terminals: HC-CARGO 191733, 191734, 192758.

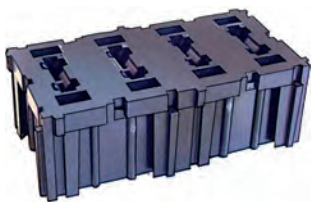

Height: 30.48 mm
Module: Fuse holder

Type/fuse: ATO
Outlets: 4 way

191719 Powr-Blok Std pkg 5 Servicing: HC-CARGO 191743

The POWR-BLOKSTM system gives you unlimited flexibility to design electrical distribution systems that range from simple to complex. Choose from a variety of POWR-BLOKSTM modules that accommodate everything you need in power distribution or circuit protection blocks, including fuses, circuit breakers, relays, flashers and specialty devices. It is the totally modular way to build your own junction block. Typical Applications: Buses, Conversion Vans, Off Road and Recreational Vehicles, Construction Equipment, Emergency Vehicles, Farm Equipment, Heavy Duty Trucks, Industrial Vehicles, Marine, High Performance and Racing Vehicles. Terminals: HC-CARGO 191733, 191734, 192758.



Height: 30.48 mm
Module: Fuse holder

Type/fuse: ATO
Outlets: 7 way

191721 Powr-Blok Std pkg 5

The POWR-BLOKSTM system gives you unlimited flexibility to design electrical distribution systems that range from simple to complex. Choose from a variety of POWR-BLOKSTM modules that accommodate everything you need in power distribution or circuit protection blocks, including fuses, circuit breakers, relays, flashers and specialty devices. It is the totally modular way to build your own junction block. Typical Applications: Buses, Conversion Vans, Off Road and Recreational Vehicles, Construction Equipment, Emergency Vehicles, Farm Equipment, Heavy Duty Trucks, Industrial Vehicles, Marine, High Performance and Racing Vehicles. Terminal: HC-CARGO 191735, 191736

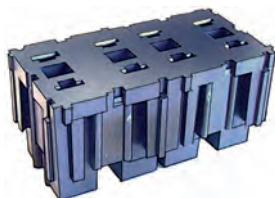

Height: 33.02 mm
Module: Fuse holder

Type/fuse: Maxi
Outlets: 4 way

191722 Powr-Blok Relay Multi Plug Std pkg 10

The POWR-BLOKSTM system gives you unlimited flexibility to design electrical distribution systems that range from simple to complex. Choose from a variety of POWR-BLOKSTM modules that accommodate everything you need in power distribution or circuit protection blocks, including fuses, circuit breakers, relays, flashers and specialty devices. It is the totally modular way to build your own junction block. Typical Applications: Buses, Conversion Vans, Off Road and Recreational Vehicles, Construction Equipment, Emergency Vehicles, Farm Equipment, Heavy Duty Trucks, Industrial Vehicles, Marine, High Performance and Racing Vehicles. Terminals: HC-CARGO 191764, 191765, 191766.

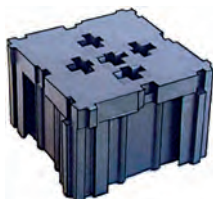

Height: 25.4 mm
Module: Relay holder

Type/fuse: ISO
No./relays: 1

191723 Powr-Blok Relay Multi Plug Std pkg 10

The POWR-BLOKSTM system gives you unlimited flexibility to design electrical distribution systems that range from simple to complex. Choose from a variety of POWR-BLOKSTM modules that accommodate everything you need in power distribution or circuit protection blocks, including fuses, circuit breakers, relays, flashers and specialty devices. It is the totally modular way to build your own junction block. Typical Applications: Buses, Conversion Vans, Off Road and Recreational Vehicles, Construction Equipment, Emergency Vehicles, Farm Equipment, Heavy Duty Trucks, Industrial Vehicles, Marine, High Performance and Racing Vehicles. Terminals: HC-CARGO 191764, 191765, 191766



Height: 25.4 mm
Module: Relay holder

Type/fuse: ISO
No./relays: 2

191724 Powr-Blok Std pkg 1

The POWR-BLOKSTM system gives you unlimited flexibility to design electrical distribution systems that range from simple to complex. Choose from a variety of POWR-BLOKSTM modules that accommodate everything you need in power distribution or circuit protection blocks, including fuses, circuit breakers, relays, flashers and specialty devices. It is the totally modular way to build your own junction block. Typical Applications: Buses, Conversion Vans, Off Road and Recreational Vehicles, Construction Equipment, Emergency Vehicles, Farm Equipment, Heavy Duty Trucks, Industrial Vehicles, Marine, High Performance and Racing Vehicles. Terminals 4.7 mm: HC-CARGO 191737, 191738. Terminals 6.3 mm: HC-CARGO 191764, 191765, 191766.

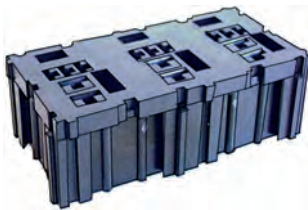

Height: 30.48 mm
Module: Relay holder

Type/fuse: Micro
No./relays: 3

191725 Powr-Blok Stud Module Std pkg 1

The POWR-BLOKSTM system gives you unlimited flexibility to design electrical distribution systems that range from simple to complex. Choose from a variety of POWR-BLOKSTM modules that accommodate everything you need in power distribution or circuit protection blocks, including fuses, circuit breakers, relays, flashers and specialty devices. It is the totally modular way to build your own junction block. Typical Applications: Buses, Conversion Vans, Off Road and Recreational Vehicles, Construction Equipment, Emergency Vehicles, Farm Equipment, Heavy Duty Trucks, Industrial Vehicles, Marine, High Performance and Racing Vehicles.

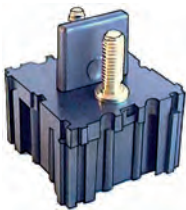

Height: 44.45 mm

Type/fuse: Assemble

191726 Powr-Blok Relay Socket Std pkg 10

The POWR-BLOKSTM system gives you unlimited flexibility to design electrical distribution systems that range from simple to complex. Choose from a variety of POWR-BLOKSTM modules that accommodate everything you need in power distribution or circuit protection blocks, including fuses, circuit breakers, relays, flashers and specialty devices. It is the totally modular way to build your own junction block. Typical Applications: Buses, Conversion Vans, Off Road and Recreational Vehicles, Construction Equipment, Emergency Vehicles, Farm Equipment, Heavy Duty Trucks, Industrial Vehicles, Marine, High Performance and Racing Vehicles. Terminals 6.3 mm: HC-CARGO 191764, 191765, 191766. Terminals 9.5 mm: HC-CARGO 191025.

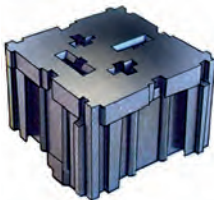

Height: 25.4 mm
Module: Relay holder

Type/fuse: Power
No./relays: 1

191744 Powr-Blok Std pkg 5

The POWR-BLOKSTM system gives you unlimited flexibility to design electrical distribution systems that range from simple to complex. Choose from a variety of POWR-BLOKSTM modules that accommodate everything you need in power distribution or circuit protection blocks, including fuses, circuit breakers, relays, flashers and specialty devices. It is the totally modular way to build your own junction block. Typical Applications: Buses, Conversion Vans, Off Road and Recreational Vehicles, Construction Equipment, Emergency Vehicles, Farm Equipment, Heavy Duty Trucks, Industrial Vehicles, Marine, High Performance and Racing Vehicles. Terminal: HC-CARGO 191739, 191740. Powr-Blok Seal: HC-CARGO 191745.



Height: 34.29 mm
Module: Fuse holder

Type/fuse: Mini
Outlets: 4 way

191767 Powr-Blok Mounting Std pkg 10

The POWR-BLOKSTM system gives you unlimited flexibility to design electrical distribution systems that range from simple to complex. Choose from a variety of POWR-BLOKSTM modules that accommodate everything you need in power distribution or circuit protection blocks, including fuses, circuit breakers, relays, flashers and specialty devices. It is the totally modular way to build your own junction block. Typical Applications: Buses, Conversion Vans, Off Road and Recreational Vehicles, Construction Equipment, Emergency Vehicles, Farm Equipment, Heavy Duty Trucks, Industrial Vehicles, Marine, High Performance and Racing Vehicles. Mounting accessory modules designed for mounting fuse block to be used w/ mounting stand -off.

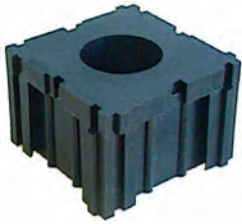

Height: 76.2 mm

BRIDGE

191743 Powr-Blok Std pkg 2

Powr-blok: HC-CARGO 191719.

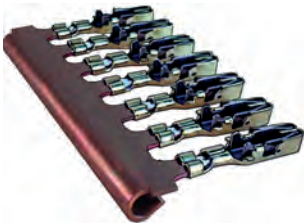

Outlets: 7 way

ACCESSORIES

191727 Powr-Blok Connecting Locks Std pkg 10

Insertable/removable locks designed to connect Powr-blok modules.

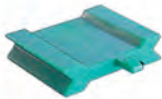

Height: 20.32 mm

191728 Powr-Blok Std pkg 10

I.D. 8 mm. O.D. 25 mm. Rigid plastic.



Height: 19 mm

191729 Powr-Blok Std pkg 10



Height: 25.4 mm

191730 Powr-Blok Std pkg 10



Height: 31.7 mm

191731 Powr-Blok Mounting Leg Std pkg 10



Height: 25 mm

191732 Powr-Blok Mounting Leg Std pkg 10



Height: 76.2 mm

SWITCHES

ROTATING

180007 3-Way Switch Std pkg 1

 Voltage: 12/24
Watt: 3

 Mount. hole size:
26 mm

 Socket type: BA7s
Button colour: Black
Switch combination: On/Off/On
Terminals: 7
Illuminated: Yes
Bulb incl.: No

180156 Rotating Switch Std pkg 1

Comes w/ 3 lenses. Red/yellow/green.

 Voltage: 12
Amp: 15

 Mount. hole size:
12.5 mm

 Bulb type: Wedge-base
Button colour: Black
Switch combination: On/Off
Terminals: 4
Illuminated: Yes
Bulb incl.: Yes
Protection degree: IP 53

180158 Rotating Switch Std pkg 1 Servicing: HC-CARGO 180159

For light, fan etc.

 Voltage: 12/24
Amp: 15/7.5

 Mount. hole size:
12.5 mm
Positions: 0-1-2-3

 Button colour: Black
Terminals: 5
Protection degree: IP 53

180314 Rotating Switch Std pkg 1

w/ blower symbol.

 Voltage: 12/24
Amp: 15/7.5

 Mount. hole size:
12.5 mm
Positions: 0-1-2

 Button colour: Black
Button symbol: Blower
Terminals: 3
Protection degree: IP 53

ACCESSORIES

180159 Multi Socket Std pkg 5

For HC-CARGO 180158.





MINI ROCKER







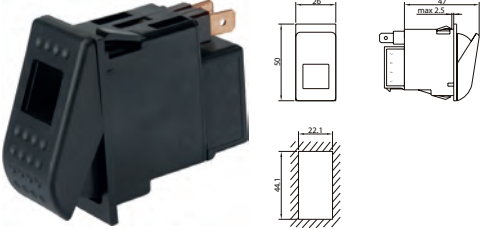
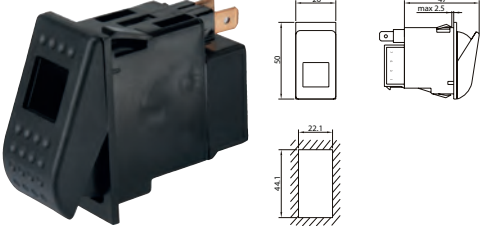

180597 Mini Rocker Switch		Std pkg 5			
			Voltage: 12/24 Amp: 20/10	Mount. hole size: 21 mm	Type/terminal: Flat Switch combination: On/Off Terminals: 2
180598 Mini Rocker Switch		Std pkg 5			
			Voltage: 12 Amp: 20	Mount. hole size: 21 mm	Type/terminal: Flat Button colour: Orange Switch combination: On/Off Terminals: 3 Illuminated: Yes
180599 Mini Rocker Switch		Std pkg 5	Servicing: Citroen, Fiat - Visit our web catalogue for further information		
			Voltage: 12 Amp: 20	Mount. hole size: 21 mm	Type/terminal: Flat Button colour: Red Switch combination: On/Off Terminals: 3 Illuminated: Yes
180600 Mini Rocker Switch		Std pkg 5			
			Voltage: 12 Amp: 10	Mount. hole size: 21 mm Positions: On-on	Button colour: Black Switch combination: On/On Terminals: 3
180601 Mini Rocker Switch		Std pkg 5			
			Voltage: 12 Amp: 20	Mount. hole size: 20 mm	Type/terminal: Flat Bulb type: LED Button colour: Red Switch combination: On/Off Terminals: 3 Illuminated: Yes Alternativ no.: 181560
180627 Mini Rocker Switch		Std pkg 5			
			Voltage: 12 Amp: 20	Mount. hole size: 21 mm	Type/terminal: Flat Button colour: Blue Switch combination: On/Off Terminals: 3 Illuminated: Yes
180628 Mini Rocker Switch		Std pkg 5			
			Voltage: 12 Amp: 20	Mount. hole size: 21 mm	Type/terminal: Flat Button colour: Green Switch combination: On/Off Terminals: 3 Illuminated: Yes

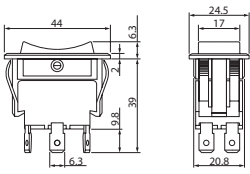

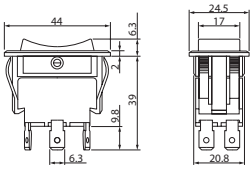

		EL. SPECIFICATIONS	DIMENSIONS	ADDITIONAL SPECIFICATIONS
181557	Mini Rocker Switch	Std pkg 5		
		Voltage: 12 Amp: 20	Mount. hole size: 20 mm	Bulb type: LED Button colour: Orange Switch combination: On/Off Material: Plastic Automatic return: No
181558	Mini Rocker Switch	Std pkg 5		
		Voltage: 12 Amp: 20	Mount. hole size: 20 mm	Type/terminal: Flat Bulb type: LED Button colour: Blue Switch combination: On/Off Material: Plastic Terminals: 3 Illuminated: Yes Automatic return: No
181559	Mini Rocker Switch	Std pkg 5		
		Voltage: 12 Amp: 20	Mount. hole size: 20 mm	Type/terminal: Flat Bulb type: LED Button colour: Green Switch combination: On/Off Material: Plastic Terminals: 3 Illuminated: Yes Automatic return: No
181607	Mini Rocker Switch	Std pkg 5		
		Voltage: 24 Amp: 10	Mount. hole size: 21 mm	Type/terminal: Flat Bulb type: LED Button colour: Red Switch combination: On/Off Terminals: 3 Illuminated: Yes
181608	Mini Rocker Switch	Std pkg 5		
		Voltage: 24 Amp: 10	Mount. hole size: 20 mm	Type/terminal: Flat Bulb type: LED Button colour: Orange Switch combination: On/Off Terminals: 3 Illuminated: Yes
181609	Mini Rocker Switch	Std pkg 5		
		Voltage: 24 Amp: 10	Mount. hole size: 20 mm	Type/terminal: Flat Bulb type: LED Button colour: Blue Switch combination: On/Off Terminals: 3 Illuminated: Yes
181610	Mini Rocker Switch	Std pkg 5		
		Voltage: 24 Amp: 10	Mount. hole size: 20 mm	Type/terminal: Flat Bulb type: LED Button colour: Green Switch combination: On/Off Terminals: 3 Illuminated: Yes

		EL. SPECIFICATIONS	DIMENSIONS	ADDITIONAL SPECIFICATIONS
182371 Mini Rocker Switch Std pkg 10 <div style="border: 1px solid black; border-radius: 50%; padding: 10px; width: fit-content; margin: 10px auto;"> <p>NEW PRODUCT www.hc-cargo.com</p> </div>		Voltage: 14 Amp: 20	Mount. hole size: 20.2 mm	Type/terminal: Flat Switch combination: On/Off/On Terminals: 3
ROCKER				
180090 Rocker Switch Std pkg 5 		Voltage: 12/24 Amp: 16/8	Mount. hole size: 28.5x11.5 mm	Switch combination: On/Off Terminals: 2
180099 Rocker Switch Std pkg 5 <i>Supplied w/ 12 V bulb.</i> 		Voltage: 12 Amp: 16	Mount. hole size: 28.5x11.5 mm	Button colour: Blue Switch combination: On/Off Terminals: 3 Illuminated: Yes
180100 Rocker Switch Std pkg 5 <i>Supplied w/ 12 V bulb.</i> 		Voltage: 12 Amp: 16	Mount. hole size: 28.5x11.5 mm	Button colour: Green Switch combination: On/Off Terminals: 3 Illuminated: Yes
180101 Rocker Switch Std pkg 5 <i>Supplied w/ 12 V bulb.</i> 		Voltage: 12 Amp: 16	Mount. hole size: 28.5x11.5 mm	Button colour: Red Switch combination: On/Off Terminals: 3 Illuminated: Yes
180176 Rocker Switch Std pkg 5 		Voltage: 12/24 Amp: 10/5	Mount. hole size: 12.5 mm	Switch combination: On/Off Terminals: 2
180177 Rocker Switch Std pkg 5 <i>Supplied w/ 12 V bulb.</i> 		Voltage: 12 Amp: 10	Mount. hole size: 12.5 mm	Button colour: Blue Switch combination: On/Off Terminals: 3 Illuminated: Yes



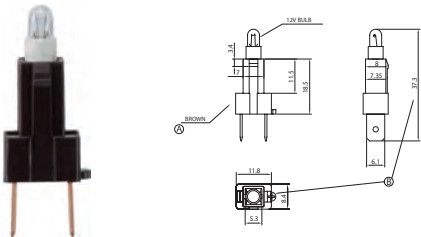
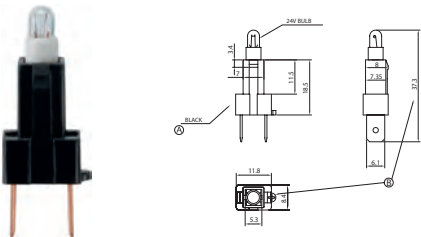





		EL. SPECIFICATIONS	DIMENSIONS	ADDITIONAL SPECIFICATIONS
180178 Rocker Switch Std pkg 5				
<i>Supplied w/ 12 V bulb.</i>				
	Voltage: 12 Amp: 10	Mount. hole size: 12.5 mm	Button colour: Green Switch combination: On/Off Terminals: 3 Illuminated: Yes	
180179 Rocker Switch Std pkg 5				
<i>Supplied w/ 12 V bulb.</i>				
	Voltage: 12 Amp: 10	Mount. hole size: 12.5 mm	Button colour: Red Switch combination: On/Off Terminals: 3 Illuminated: Yes	
180180 Rocker Switch Std pkg 5				
<i>Supplied w/ 12 V bulb.</i>				
	Voltage: 12 Amp: 10	Mount. hole size: 12.5 mm Positions: 3	Button colour: Orange Switch combination: On/Off Terminals: 3 Illuminated: Yes	
180206 Rocker Switch Std pkg 1				
<i>w/o symbol plate. Illuminated w/ location and function light. Bulb: HC-CARGO 181615, 181667 (LED). Blind cover: HC-CARGO 181661. Multi Plug: HC-CARGO 180208. Plastic Module Panel: HC-CARGO 181662, 181663, 181664, 181665, 181666. Symbol Plate: HC-CARGO 180209, 180210, 181462, 181463, 181641...181660.</i>				
	Voltage: 12 Amp: 16 Watt: 1.2	Mount. hole size: 22.1x44.1 mm	Bulb type: 170758 Socket type: T5 Switch combination: On/Off Terminals: 4 Illuminated: Yes Bulb incl.: Yes	
180207 Rocker Switch Std pkg 1				
<i>w/o symbol plate. Illuminated w/ location and function light. Bulb: HC-CARGO 181632, 181668 (LED). Blind cover: HC-CARGO 181661. Multi Plug: HC-CARGO 180208. Plastic Module Panel: HC-CARGO 181662, 181663, 181664, 181665, 181666. Symbol Plate: HC-CARGO 180209, 180210, 181462, 181463, 181641...181660.</i>				
	Voltage: 24 Amp: 8 Watt: 1.2	Mount. hole size: 22.1x44.1 mm	Socket type: T5 Switch combination: On/Off Terminals: 4 Illuminated: Yes Bulb incl.: Yes	
181546 Rocker Switch Std pkg 1				
<i>w/o symbol plate. Illuminated w/ location and function light. Bulb: HC-CARGO 181615, 181667 (LED), 181632, 181668 (LED). Blind cover: HC-CARGO 181661. Multi Plug: HC-CARGO 180208. Plastic Module Panel: HC-CARGO 181662, 181663, 181664, 181665, 181666. Symbol Plate: HC-CARGO 180209, 180210, 181462, 181463, 181641...181660.</i>				
	Voltage: 12/24	Mount. hole size: 22.1x44.1 mm	Type/terminal: Flat Switch combination: (On)/Off/(On) Terminals: 6 Bulb incl.: No Automatic return: Yes Alternativ no.: 182370	







		EL. SPECIFICATIONS	DIMENSIONS	ADDITIONAL SPECIFICATIONS
181554	Rocker Switch	Std pkg 5		
		Voltage: 12 Amp: 16	Mount. hole size: 12.5 mm	Bulb type: LED Button colour: Orange Switch combination: On/Off Material: Plastic Terminals: 3 Automatic return: No
181555	Rocker Switch	Std pkg 5		
		Voltage: 12 Amp: 16	Mount. hole size: 12.5 mm	Bulb type: LED Colour: Green Switch combination: On/Off Material: Plastic Terminals: 3 Automatic return: No
181556	Rocker Switch	Std pkg 5		
		Voltage: 12 Amp: 30	Mount. hole size: 12.5 mm	Bulb type: LED Button colour: Red Switch combination: On/Off Material: Plastic Terminals: 3 Automatic return: No
181638	Rocker Switch	Std pkg 1		
<i>w/o symbol plate. Illuminated w/ location and function light. Bulb: HC-CARGO 181615, 181667 (LED). Blind cover: HC-CARGO 181661. Multi Plug: HC-CARGO 180208. Plastic Module Panel: HC-CARGO 181662, 181663, 181664, 181665, 181666. Symbol Plate: HC-CARGO 180209, 180210, 181462, 181463, 181641...181660.</i>				
		Voltage: 12 Amp: 16 Watt: 1.2	Mount. hole size: 22.1x44.1 mm	Socket type: T5 Switch combination: On/Off Terminals: 4 Bulb incl.: Yes Automatic return: Yes
181639	Rocker Switch	Std pkg 1		
<i>w/o symbol plate. Illuminated w/ location and function light. Bulb: HC-CARGO 181632, 181668 (LED). Blind cover: HC-CARGO 181661. Multi Plug: HC-CARGO 180208. Plastic Module Panel: HC-CARGO 181662, 181663, 181664, 181665, 181666. Symbol Plate: HC-CARGO 180209, 180210, 181462, 181463, 181641...181660.</i>				
		Voltage: 24 Amp: 8 Watt: 1.2	Mount. hole size: 22.1x44.1 mm	Socket type: T5 Switch combination: On/Off Terminals: 4 Bulb incl.: Yes Automatic return: Yes
181640	Rocker Switch	Std pkg 1		
<i>w/o symbol plate. Illuminated w/ location and function light. Bulb: HC-CARGO 181615, 181667 (LED), 181632, 181668 (LED). Blind cover: HC-CARGO 181661. Multi Plug: HC-CARGO 180208. Plastic Module Panel: HC-CARGO 181662, 181663, 181664, 181665, 181666. Symbol Plate: HC-CARGO 180209, 180210, 181462, 181463, 181641...181660.</i>				
		Voltage: 12/24	Mount. hole size: 22.1x44.1 mm	Type/terminal: Flat Switch combination: (On)/Off/(On) Terminals: 6 Bulb incl.: No Automatic return: Yes

		EL. SPECIFICATIONS	DIMENSIONS	ADDITIONAL SPECIFICATIONS
182369	Rocker Switch	Std pkg 1		
		Voltage: 12/24 Amp: 20/10	Mount. hole size: 22.2x37.3 mm	Type/terminal: Flat Switch combination: On/Off/On Terminals: 6 Automatic return: No
182370	Rocker Switch	Std pkg 1		
		Voltage: 12/24 Amp: 20/10	Mount. hole size: 21.2x37.3 mm	Type/terminal: Flat Switch combination: (On)/Off/(On) Terminals: 6 Automatic return: Yes Alternativ no.: 181546
211123	Rocker Switch	Std pkg 1	Servicing: HC-CARGO 211083, 211097	
		Voltage: 12/24		Type/terminal: Flat Terminals: 3
ACCESSORIES				
180208	Multi Plug	Std pkg 10	Servicing: HC-CARGO 180206, 180207, 181546, 181638, 181639, 181640	
<i>For SWF-type switches. Terminal: HC-CARGO 19025, 190868, 192377, 192376, 191029.</i>				
				Type/terminal: Flat No./poles: 8 Plug: Female
180209	Symbol Plate	Std pkg 10	Servicing: HC-CARGO 180206, 180207, 181546, 181638, 181639, 181640	
				Colour: Yellow Symbol: Rotating beacon
180210	Symbol Plate	Std pkg 10	Servicing: HC-CARGO 180206, 180207, 181546, 181638, 181639, 181640	
				Colour: Green Symbol: Work Light, front
181462	Symbol Plate	Std pkg 10	Servicing: HC-CARGO 180206, 180207, 181546, 181638, 181639, 181640	
				Colour: Green

		EL. SPECIFICATIONS	DIMENSIONS	ADDITIONAL SPECIFICATIONS
181463	Symbol Plate	Std pkg 10	Servicing: HC-CARGO 180206, 180207, 181546, 181638, 181639, 181640	Colour: Red
				
181615	Bulb Holder 12 V	Std pkg 5	Servicing: HC-CARGO 180206, 181546, 181638, 181640	
<i>Bulb: HC-CARGO 170758.</i>				
		Voltage: 12		
181632	Bulb Holder 24 V	Std pkg 5	Servicing: HC-CARGO 180207, 181546, 181639, 181640	
<i>Bulb: HC-CARGO 171029.</i>				
		Voltage: 24		
181641	Symbol Plate	Std pkg 10	Servicing: HC-CARGO 180206, 180207, 181546, 181638, 181639, 181640	Colour: Green Symbol: High Beam
				
181642	Symbol Plate	Std pkg 10	Servicing: HC-CARGO 180206, 180207, 181546, 181638, 181639, 181640	Colour: Green Symbol: Fog Light
				
181643	Symbol Plate	Std pkg 10	Servicing: HC-CARGO 180206, 180207, 181546, 181638, 181639, 181640	Colour: Black Symbol: Parking light
				
181644	Symbol Plate	Std pkg 10	Servicing: HC-CARGO 180206, 180207, 181546, 181638, 181639, 181640	Colour: Red Symbol: Hazard Warning Lamp
				

		EL. SPECIFICATIONS	DIMENSIONS	ADDITIONAL SPECIFICATIONS
181645	Symbol Plate	Std pkg 10	Servicing: HC-CARGO 180206, 180207, 181546, 181638, 181639, 181640	Colour: Black Symbol: Interior Lighting
181646	Symbol Plate	Std pkg 10	Servicing: HC-CARGO 180206, 180207, 181546, 181638, 181639, 181640	Colour: Green Symbol: Work Light
181647	Symbol Plate	Std pkg 10	Servicing: HC-CARGO 180206, 180207, 181546, 181638, 181639, 181640	Colour: Green Symbol: Work Light
181648	Symbol Plate	Std pkg 10	Servicing: HC-CARGO 180206, 180207, 181546, 181638, 181639, 181640	Colour: Black Symbol: Loading Floor Lamp
181649	Symbol Plate	Std pkg 10	Servicing: HC-CARGO 180206, 180207, 181546, 181638, 181639, 181640	Colour: Green Symbol: Rotating beacon
181650	Symbol Plate	Std pkg 10	Servicing: HC-CARGO 180206, 180207, 181546, 181638, 181639, 181640	Colour: Green Symbol: Wiper & Washer
181651	Symbol Plate	Std pkg 10	Servicing: HC-CARGO 180206, 180207, 181546, 181638, 181639, 181640	Colour: Green Symbol: Horn
181652	Symbol Plate	Std pkg 10	Servicing: HC-CARGO 180206, 180207, 181546, 181638, 181639, 181640	Colour: Green Symbol: Blower

		EL. SPECIFICATIONS	DIMENSIONS	ADDITIONAL SPECIFICATIONS
181653	Symbol Plate	Std pkg 10	Servicing: HC-CARGO 180206, 180207, 181546, 181638, 181639, 181640	Colour: Green Symbol: Washer
				
181654	Symbol Plate	Std pkg 10	Servicing: HC-CARGO 180206, 180207, 181546, 181638, 181639, 181640	Colour: Green Symbol: Windscreen Wiper
				
181655	Symbol Plate	Std pkg 10	Servicing: HC-CARGO 180206, 180207, 181546, 181638, 181639, 181640	Colour: Green Symbol: Seat Heating
				
181656	Symbol Plate	Std pkg 10	Servicing: HC-CARGO 180206, 180207, 181546, 181638, 181639, 181640	Colour: Green Symbol: Parking Brake
				
181657	Symbol Plate	Std pkg 10	Servicing: HC-CARGO 180206, 180207, 181546, 181638, 181639, 181640	Colour: Green Symbol: Indicator
				
181658	Symbol Plate	Std pkg 10	Servicing: HC-CARGO 180206, 180207, 181546, 181638, 181639, 181640	Colour: Green Symbol: Rear Window Wiper
				
181659	Symbol Plate	Std pkg 10	Servicing: HC-CARGO 180206, 180207, 181546, 181638, 181639, 181640	Colour: Green Symbol: Rear Windscreen Wash
				
181660	Symbol Plate	Std pkg 10	Servicing: HC-CARGO 180206, 180207, 181546, 181638, 181639, 181640	Colour: Green Symbol: Heating & Ventilation
				

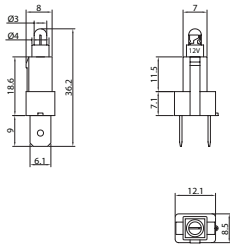
		EL. SPECIFICATIONS	DIMENSIONS	ADDITIONAL SPECIFICATIONS
181661	Blind cover	Std pkg 5	Servicing: HC-CARGO 180206, 180207, 181546, 181638, 181639, 181640	
				
181662	Plastic Module Panel	Std pkg 5	Servicing: HC-CARGO 180206, 180207, 181546, 181638, 181639, 181640	
				
181663	Plastic Module Panel	Std pkg 5	Servicing: HC-CARGO 180206, 180207, 181546, 181638, 181639, 181640	
<i>Can be assembled in rows.</i>				
				
181664	Plastic Module Panel	Std pkg 5	Servicing: HC-CARGO 180206, 180207, 181546, 181638, 181639, 181640	
<i>Can be assembled in rows (end piece.)</i>				
				
181665	Plastic Module Panel	Std pkg 1	Servicing: HC-CARGO 180206, 180207, 181546, 181638, 181639, 181640	
<i>3 holes.</i>				
				
181666	Plastic Module Panel	Std pkg 1	Servicing: HC-CARGO 180206, 180207, 181546, 181638, 181639, 181640	
<i>6 holes.</i>				
				
181667	Bulb Holder 12 V LED	Std pkg 5	Servicing: HC-CARGO 180206, 181546, 181638, 181640 Voltage: 12	
 				

181668 Bulb Holder 24 V LED		Std pkg 5	Servicing: HC-CARGO 180207, 181546, 181639, 181640
		Voltage: 24	

TOGGLE
METAL ARM

180039 3-Way Switch		Std pkg 1
----------------------------	--	-----------

For steering column of 35-40 mm.

	Voltage: 12/24 Amp: 16/8 Watt: 1.5	Bulb type: T 1 1/2 Midget Socket type: T-1 1/2 Button colour: Green Switch combination: On/Off/On Illuminated: Yes Bulb incl.: Yes
--	--	---

180048 3-Way Switch		Std pkg 5
----------------------------	--	-----------

	Voltage: 12 Amp: 20	Mount. hole size: 12.5 mm	Button colour: Black Switch combination: On/Off/On No./terminals w/screw: 3
--	------------------------	------------------------------	---

180584 Toggle Switch		Std pkg 1
-----------------------------	--	-----------

Rubber Boot: HC-CARGO 181672. Cover For Toggle Switch: HC-CARGO 181551, 181552.

	Voltage: 12/24 Amp: 16/8	Mount. hole size: 12 mm	Switch combination: On/Off Material: Metal Terminals: 2 Arm: Short
--	-----------------------------	----------------------------	---

180585 Toggle Switch		Std pkg 1
-----------------------------	--	-----------







Rubber Boot: HC-CARGO 181672. Spring loaded = (On).





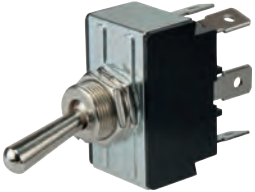
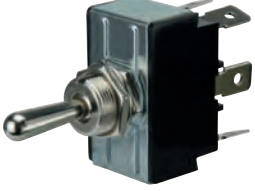

	Voltage: 12/24 Amp: 16/8	Mount. hole size: 12 mm	Switch combination: On/(On) Material: Metal Terminals: 3 Arm: Short
--	-----------------------------	----------------------------	--

180586 Toggle Switch		Std pkg 1
-----------------------------	--	-----------

Rubber Boot: HC-CARGO 181672.

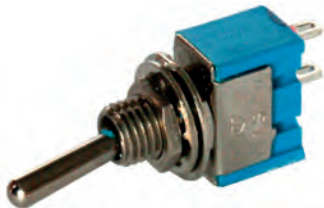
	Voltage: 12/24 Amp: 16/8	Mount. hole size: 12 mm	Switch combination: On/On Material: Metal Terminals: 3 Arm: Short
--	-----------------------------	----------------------------	--

EL. SPECIFICATIONS		DIMENSIONS	ADDITIONAL SPECIFICATIONS
180587 Toggle Switch Std pkg 1			
<i>Rubber Boot: HC-CARGO 181672. Spring loaded = (On).</i>			
	Voltage: 12/24 Amp: 16/8	Mount. hole size: 12 mm	Switch combination: (On)/Off/(On) Material: Metal Terminals: 3 Arm: Short
180588 Toggle Switch Std pkg 1 Servicing: Ford - Visit our web catalogue for further information			
<i>Rubber Boot: HC-CARGO 181672. Spring loaded = (On).</i>			
	Voltage: 12/24 Amp: 16/8	Mount. hole size: 12 mm	Switch combination: On/Off/(On) Material: Metal Terminals: 3 Arm: Short
180589 Toggle Switch Std pkg 1			
<i>Rubber Boot: HC-CARGO 181672.</i>			
	Voltage: 12/24 Amp: 16/8	Mount. hole size: 12 mm	Switch combination: On/Off/On Material: Metal Terminals: 3 Arm: Short
180590 Toggle Switch Std pkg 1			
<i>Rubber Boot: HC-CARGO 181672.</i>			
	Voltage: 12/24 Amp: 16/8	Mount. hole size: 12 mm	Switch combination: On/Off Material: Metal Terminals: 4 Arm: Short 2 poles: w/
180591 Toggle Switch Std pkg 1			
<i>Rubber Boot: HC-CARGO 181672.</i>			
	Voltage: 12/24 Amp: 16/8	Mount. hole size: 12 mm	Switch combination: On/On Material: Metal Terminals: 6 Arm: Short 2 poles: w/
180592 Toggle Switch Std pkg 1			
<i>Rubber Boot: HC-CARGO 181672. Spring loaded = (On).</i>			
	Voltage: 12/24 Amp: 16/8	Mount. hole size: 12 mm	Switch combination: (On)/Off/(On) Material: Metal Terminals: 6 Arm: Short 2 poles: w/
180593 Toggle Switch Std pkg 1			
<i>Rubber Boot: HC-CARGO 181672. Spring loaded = (On).</i>			
	Voltage: 12/24 Amp: 16/8	Mount. hole size: 12 mm	Switch combination: On/Off/(On) Material: Metal Terminals: 6 Arm: Short 2 poles: w/

180594 Toggle Switch		Std pkg 1	
Rubber Boot: HC-CARGO 181672. Cover For Toggle Switch: HC-CARGO 181551, 181552.			
	Voltage: 12/24 Amp: 16/8	Mount. hole size: 12 mm	Switch combination: On/Off/On Material: Metal Terminals: 6 Arm: Short 2 poles: w/
180618 Toggle Switch		Std pkg 1	
Spring loaded = (On).			
	Voltage: 12/24 Amp: 6/3	Mount. hole size: 12 mm	Switch combination: (On)/Off/(On) Material: Metal Terminals: 3 Arm: Long
181276 Mini Toggle Switch		Std pkg 5	
	Voltage: 12/24 Amp: 6/3	Mount. hole size: 6 mm	Switch combination: On/Off Material: Metal Terminals: 2 Arm: Short
181277 Mini Toggle Switch		Std pkg 5	
	Voltage: 12/24 Amp: 6/3	Mount. hole size: 6 mm	Switch combination: On/On Material: Metal Terminals: 3 Arm: Short
181278 Mini Toggle Switch		Std pkg 5	
	Voltage: 12/24 Amp: 6/3	Mount. hole size: 6 mm	Switch combination: On/Off/On Material: Metal Terminals: 3 Arm: Short
PLAST ARM			
180018 Toggle Switch		Std pkg 5	
	Voltage: 12/24 Amp: 10/5	Mount. hole size: 12.5 mm	Colour: Black Switch combination: On/Off Terminals: 2 Arm: Long
180036 3-Way Switch		Std pkg 5	
	Voltage: 12/24 Amp: 16/8	Mount. hole size: 12.5 mm	Button colour: Black Switch combination: On/Off/On Terminals: 3 Arm: Short

<p>180088 Toggle Switch Std pkg 5</p> <p><i>Spring loaded = (On).</i></p>		<p>Voltage: 12/24 Amp: 16/8</p>	<p>Mount. hole size: 12.5 mm</p> <p>Colour: Black Switch combination: Off/(On) Terminals: 2 Arm: Short</p>
<p>180091 Toggle Switch Std pkg 5</p>		<p>Voltage: 12 Amp: 10</p>	<p>Mount. hole size: 12.5 mm</p> <p>Colour: Blue Switch combination: On/Off Terminals: 3 Arm: Short Illuminated: Yes Bulb incl.: Yes</p>
<p>180092 Toggle Switch Std pkg 5</p>		<p>Voltage: 12 Amp: 10</p>	<p>Mount. hole size: 12.5 mm</p> <p>Colour: Green Switch combination: On/Off Terminals: 3 Arm: Short Illuminated: Yes Bulb incl.: Yes</p>
<p>180094 Toggle Switch Std pkg 5</p>		<p>Voltage: 12 Amp: 10</p>	<p>Mount. hole size: 12.5 mm</p> <p>Colour: Red Switch combination: On/Off Terminals: 3 Arm: Short Illuminated: Yes Bulb incl.: Yes</p>
<p>180140 Toggle Switch Std pkg 5</p>		<p>Voltage: 12/24 Amp: 10/5</p>	<p>Mount. hole size: 12.5 mm</p> <p>Colour: Black Switch combination: On/Off Terminals: 2 Arm: Short</p>
<p>180141 Toggle Switch Std pkg 5</p>		<p>Voltage: 12/24 Amp: 5/2.5</p>	<p>Mount. hole size: 12.5 mm</p> <p>Colour: Black Switch combination: On/On Terminals: 3 Arm: Short 2 poles: w/</p>

ACCESSORIES

<p>180595 Rubber Boot Std pkg 5 Servicing: HC-CARGO 180585</p>		<p>Thread: M12x1</p>	<p>Thread type: Internal Material: Rubber</p>
---	---	----------------------	---

		EL. SPECIFICATIONS	DIMENSIONS	ADDITIONAL SPECIFICATIONS
181551	Cover For Toggle Switch	Std pkg 5	Servicing: HC-CARGO 180584, 180594	
				Colour: Red Automatic return: Yes
181552	Cover For Toggle Switch	Std pkg 5	Servicing: HC-CARGO 180584, 180594	
				Colour: Yellow Automatic return: Yes
181672	Rubber Boot	Std pkg 5	Servicing: HC-CARGO 180584, 180586, 180587, 180588, 180589, 180590, 180591, 180592, 180593, 180594	
			Thread: M12x0.75	Thread type: Internal Material: Rubber
PUSH-PULL				
180010	Push/Pull Switch	Std pkg 1	For lights ect.	
		Voltage: 12 Amp: 30	Mount. hole size: 10 mm	Button colour: Black Switch combination: Off/On/On No./terminals w/screw: 4
180021	Push/Pull Switch	Std pkg 1	Max. 3 W BA 7 bulb.	
		Voltage: 12/24 Amp: 6/3	Mount. hole size: 12.5 mm	Type/terminal: Flat Button colour: Orange Switch combination: On/Off Terminals: 2 Illuminated: Yes Bulb incl.: No
180022	Push/Pull Switch	Std pkg 1	Max. 3 W BA 7 bulb.	
		Voltage: 12/24 Amp: 6/3	Mount. hole size: 12.5 mm	Type/terminal: Terminal Button colour: Green Switch combination: On/Off Terminals: 2 Illuminated: Yes Bulb incl.: No
180023	Push/Pull Switch	Std pkg 1	Max. 3 W BA 7 bulb.	
		Voltage: 12/24 Amp: 6/3	Mount. hole size: 12.5 mm	Type/terminal: Terminal Button colour: Red Switch combination: On/Off Terminals: 2 Illuminated: Yes Bulb incl.: No

		EL. SPECIFICATIONS	DIMENSIONS	ADDITIONAL SPECIFICATIONS	
180103 Push/Pull Switch Std pkg 5			Voltage: 12/24 Amp: 25/12.5	Neck: Short Mount. hole size: 8 mm	Type/terminal: Screw Button colour: Black Switch combination: On/Off No./terminals w/screw: 2 Illuminated: No
180104 Push/Pull Switch Std pkg 5			Voltage: 12/24 Amp: 25/12.5	Neck: Long Mount. hole size: 8 mm	Button colour: Black Switch combination: On/Off No./terminals w/screw: 2
181233 Push/Pull Switch Std pkg 5			Voltage: 12/24 Amp: 25/12.5	Neck: Short Mount. hole size: 8 mm	Type/terminal: Flat Button colour: Black Switch combination: On/Off Terminals: 2
PUSH BUTTON					
180040 Push Button Switch Std pkg 1			Voltage: 12/24 Amp: 25/12.5	Mount. hole size: 22.5 mm	Switch combination: Off/(On) No./terminals w/screw: 2 Moulded: Yes DIN norm: 72764
<i>Rubber Boot: HC-CARGO 181272. Spring loaded = (On).</i>					
180049 Push Button Switch Std pkg 1			Voltage: 12/24 Amp: 25/12.5	Mount. hole size: 22.5 mm	Button colour: Black Switch combination: Off/(On) No./terminals w/screw: 2 DIN norm: 72764
<i>Rubber Boot: HC-CARGO 181272. Spring loaded = (On).</i>					
180121 Push Button Switch Std pkg 1			Voltage: 12/24 Amp: 25/12.5	Mount. hole size: 22 mm	Button colour: Black Switch combination: Off/(On) Material: Metal No./terminals w/screw: 2 DIN norm: 72764
<i>Spring loaded = (On).</i>					

180215 Push Button Switch Std pkg 1 <i>Rubber Boot: HC-CARGO 181272. Spring loaded = (On).</i>			
	Voltage: 12/24 Amp: 25/12.5	Mount. hole size: 22.5 mm	Switch combination: Off/(On) No./terminals w/screw: 2 Moulded: Yes Silver contact: Yes
180400 Push Button Switch Std pkg 1 <i>Depth: 20 mm. Spring loaded = (On).</i>			
	Voltage: 12/24 Amp: 7/3.5	Mount. hole size: 15.5 mm	Type/terminal: Screw Button colour: Black Switch combination: Off/(On) No./terminals w/screw: 2
SPARE PARTS			
181272 Rubber Boot Std pkg 10 Servicing: HC-CARGO 180049, 180040, 180215			
		OD: 28.3 mm Length: 18 mm	Colour: Black Material: Rubber
PUSH-PUSH			
180123 On/Off Switch Std pkg 1			
	Voltage: 12/24	Mount. hole size: 8 mm	Button colour: White Switch combination: On/Off No./terminals w/screw: 2
181564 Push Button Switch Std pkg 1 <i>Illuminated ring. Vandal proof.</i>			
	Voltage: 12/24 Amp: <2 Voltage 2: 250 Amp 2: 3	Mount. hole size: 16 mm	Type/terminal: Solder Socket type: LED Colour: Red Switch combination: On/Off Material: Nickel plated brass Moulded: No Silver contact: Yes Protection degree: IP 67
181565 Push Button Switch Std pkg 1 <i>Illuminated ring. Vandal proof.</i>			
	Voltage: 12/24 Amp: <2 Voltage 2: 250 Amp 2: 3	Mount. hole size: 16 mm	Type/terminal: Solder Socket type: LED Button colour: Green Switch combination: On/Off Material: Nickel plated brass Moulded: No Silver contact: Yes Protection degree: IP 67

181566 Push Button Switch Std pkg 1

Illuminated ring. Vandal proof.

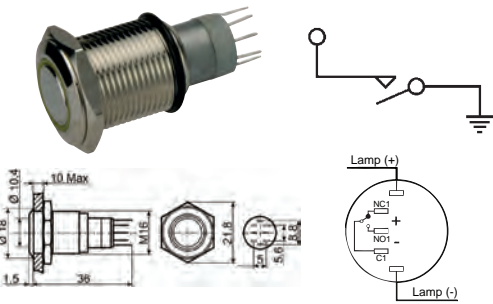

Voltage: 12/24
Amp: <2
Voltage 2: 250
Amp 2: 3

Mount. hole size:
16 mm

Type/terminal: Solder
Socket type: LED
Button colour: Yellow
Switch combination: On/Off
Material: Nickel plated brass
Moulded: No
Silver contact: Yes
Protection degree: IP 67

181567 Push Button Switch Std pkg 1

Illuminated ring. Vandal proof.

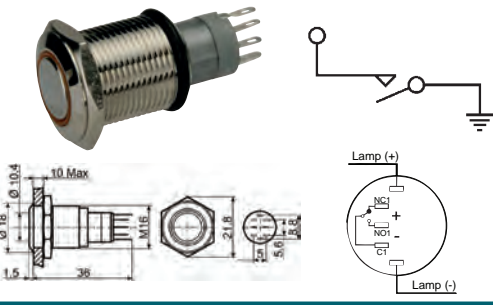

Voltage: 12/24
Amp: <2
Voltage 2: 250
Amp 2: 3

Mount. hole size:
16 mm

Type/terminal: Solder
Socket type: LED
Button colour: Orange
Switch combination: On/Off
Material: Nickel plated brass
Moulded: No
Silver contact: Yes
Protection degree: IP 67

181568 Push Button Switch Std pkg 1

Illuminated ring. Vandal proof.

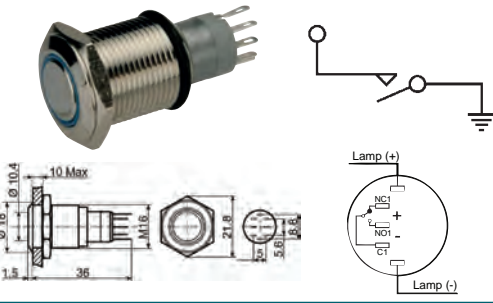

Voltage: 12/24
Amp: <2
Voltage 2: 250
Amp 2: 3

Mount. hole size:
16 mm

Type/terminal: Solder
Socket type: LED
Button colour: Blue
Switch combination: On/Off
Material: Nickel plated brass
Moulded: No
Silver contact: Yes
Protection degree: IP 67

181569 Push Button Switch Std pkg 1

Illuminated ring. Vandal proof.

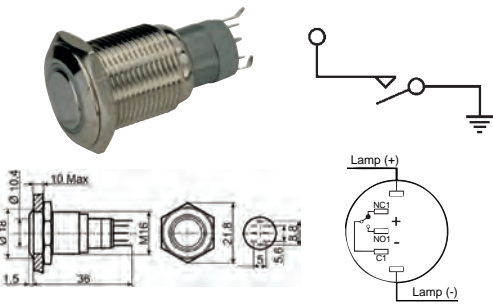

Voltage: 12/24
Amp: <2
Voltage 2: 250
Amp 2: 3

Mount. hole size:
16 mm

Type/terminal: Solder
Socket type: LED
Colour: White
Button colour: Blank
Switch combination: On/Off
Material: Nickel plated brass
Moulded: No
Silver contact: Yes
Protection degree: IP 67

MULTI PURPOSE

181249 Push Switch Std pkg 1



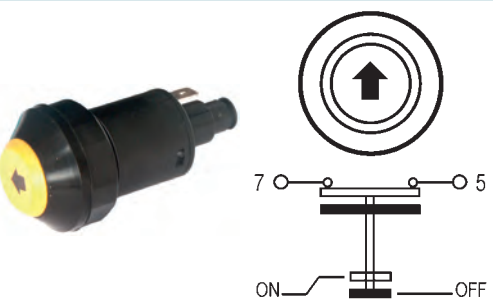







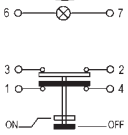

Spring loaded = (On).

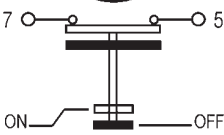

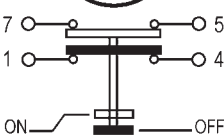
Voltage: 12/24
Amp: 50/25

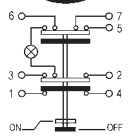
Mount. hole size:
30.5 mm

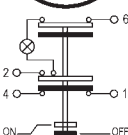
Button symbol: Lift & lower
Switch combination: Off/(On)
Terminals: 2
DIN norm: 40053
Protection degree: IP 67

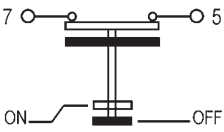
		EL. SPECIFICATIONS	DIMENSIONS	ADDITIONAL SPECIFICATIONS
181251 Push Switch Std pkg 1				
	 	Voltage: 12/24 Amp: 50/25	Mount. hole size: 30.5 mm	Button symbol: Rotating beacon Switch combination: On/Off Terminals: 6 Illuminated: Yes DIN norm: 40053 Protection degree: IP 67
181252 Push Switch Std pkg 1 <i>Spring loaded = (On).</i>				
	 	Voltage: 12/24 Amp: 50/25	Mount. hole size: 30.5 mm	Button symbol: Start Switch combination: Off/(On) Terminals: 2 DIN norm: 40053 Protection degree: IP 67
181253 Push Switch Std pkg 1				
	 	Voltage: 12/24 Amp: 50/25	Mount. hole size: 30.5 mm	Button symbol: Adjustable light Switch combination: On/Off Terminals: 4 Illuminated: Yes DIN norm: 40053 Protection degree: IP 67
181256 Push Switch Std pkg 1				
	 	Voltage: 12/24 Amp: 50/25	Mount. hole size: 30.5 mm	Button symbol: Hazard Warning Lamp Switch combination: On/Off Terminals: 7 Illuminated: Yes Automatic return: Yes DIN norm: 40053 Protection degree: IP 67
181257 Push Switch Std pkg 1				
	 	Voltage: 12/24 Amp: 50/25	Mount. hole size: 30.5 mm	Button symbol: Sidemarker Switch combination: On/Off Terminals: 4 Illuminated: Yes DIN norm: 40053 Protection degree: IP 67
181258 Push Switch Std pkg 1 <i>Spring loaded = (On).</i>				
	 	Voltage: 12/24 Amp: 50/25	Mount. hole size: 30.5 mm	Button symbol: Horn Switch combination: Off/(On) Terminals: 2 DIN norm: 40053 Protection degree: IP 67

181263 Push Switch

Std pkg 1

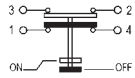

6 7

 Voltage: 12/24
Amp: 50/25

 Mount. hole size:
30.5 mm

 Switch combination: On/Off
Terminals: 6
Illuminated: Yes
Automatic return: Yes
DIN norm: 40053
Protection degree: IP 67

181264 Multi Socket

Std pkg 5

Servicing: Renault - Visit our web catalogue for further information

For multi purpose switches.

 Type/terminal: Flat
No./poles: 7

DOOR & BURGLAR ALARM

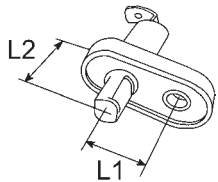
180254 Door Switch

Std pkg 2

Universal.

 L1 dim.: 10-15 mm
L2 dim.: 0-20 mm
L2/self adjustable: Yes

Terminals: 1

180255 Door Switch

Std pkg 2

Universal.

 L1 dim.: 10-15 mm
L2 dim.: 0-20 mm
L2/self adjustable: Yes

Terminals: 2

180261 Door Switch

Std pkg 10

For luggage compartment.

 L1 dim.: 15 mm
L2 dim.: 49 mm
L2/self adjustable: Yes

Terminals: 1

180263 Door Switch







Std pkg 10

Servicing: Austin, Rover - Visit our web catalogue for further information

 L1 dim.: 13 mm
L2 dim.: 15 mm



Terminals: 1

		EL. SPECIFICATIONS	DIMENSIONS	ADDITIONAL SPECIFICATIONS
180265	Door Switch	Std pkg 2	Servicing: Fiat, Seat - Visit our web catalogue for further information	
			L1 dim.: 12 mm L2 dim.: 9 mm	Terminals: 1
180266	Door Switch	Std pkg 2	Servicing: Fiat Uno - Visit our web catalogue for further information	
			L1 dim.: 15 mm L2 dim.: 9 mm	Terminals: 2
180268	Door/Alarm Switch	Std pkg 1		
<i>Universal.</i>				
			L1 dim.: 11 mm L2 dim.: 22 mm Dist. mount. holes: 22 mm	Terminals: 1
180269	Door Switch	Std pkg 1		
<i>Universal.</i>				
			L1 dim.: 12 mm L2 dim.: 4.5 mm Dist. mount. holes: 22 mm	Terminals: 1
180529	Door Switch	Std pkg 1		
<i>Universal.</i>				
			L1 dim.: 14.5 mm L2 dim.: 12 mm Dist. mount. holes: 30 mm	Terminals: 2
180625	Door/Alarm Switch	Std pkg 10		
<i>Universal. Suitable for cutting to length.</i>				
			L1 dim.: 15 mm L2 dim.: 40 mm	Terminals: 1
JUNCTION BOXES				
191183	Junction Box	Std pkg 1		
			Length: 75 mm Height: 35 mm Width: 75 mm	Cable entries: 12 Connection block: No

EL. SPECIFICATIONS		DIMENSIONS	ADDITIONAL SPECIFICATIONS
191202	Junction Box Std pkg 1		Length: 120 mm Height: 36 mm Width: 79 mm Mount.: Screw Locking device: Mounting bracket Material/house: Plastic No./poles: 6 Cable entries: 4 Waterproof: Yes Dust proof: Yes
191203	Junction Box Std pkg 1		Length: 120 mm Height: 36 mm Width: 79 mm Type: Dual Mount.: Terminal Locking device: Mounting bracket Material/house: Plastic No./poles: 8 Cable entries: 4 Waterproof: Yes Dust proof: Yes
191204	Junction Box Std pkg 1		Length: 120 mm Height: 36 mm Width: 79 mm Mount.: Screw Locking device: Mounting bracket Material/house: Plastic No./poles: 8 Cable entries: 4 Waterproof: Yes Dust proof: Yes
191205	Junction Box Std pkg 1		Length: 120 mm Height: 36 mm Width: 79 mm Mount.: Terminal Locking device: Mounting bracket Material/house: Plastic No./poles: 12 Cable entries: 4 Waterproof: Yes Dust proof: Yes
191206	Junction Box Std pkg 1		Length: 120 mm Height: 36 mm Width: 79 mm Mount.: Screw Locking device: Mounting bracket Material/house: Plastic No./poles: 12 Cable entries: 4 Waterproof: Yes Dust proof: Yes
191207	Junction Box Std pkg 1		Length: 140 mm Height: 47 mm Width: 100 mm Type: Dual Mount.: Terminal Locking device: Mounting bracket Material/house: Plastic No./poles: 12 Cable entries: 6 Waterproof: Yes Dust proof: Yes
191208	Junction Box Std pkg 1		Length: 145 mm Height: 45 mm Width: 100 mm Mount.: Terminal Locking device: Screw Material/house: Plastic No./poles: 24 Cable entries: 4 Waterproof: Yes Dust proof: Yes

EL. SPECIFICATIONS		DIMENSIONS	ADDITIONAL SPECIFICATIONS
191209 Junction Box	Std pkg 1		
		Length: 150 mm Height: 45 mm Width: 93 mm	Type: Dual Mount.: Terminal Locking device: Mounting bracket Material/house: Plastic Material/lid: Aluminium No./poles: 8 Waterproof: Yes Dust proof: Yes
191210 Junction Box	Std pkg 1		
		Length: 120 mm Height: 30 mm Width: 69 mm	Mount.: Screw Locking device: Mounting bracket Material/house: Plastic Material/lid: Aluminium No./poles: 6 Waterproof: Yes Dust proof: Yes
191211 Junction Box	Std pkg 1		
<i>Cable entries and blind: HC-CARGO 191220, 191221, 191222, 191223. Terminal Block: HC-CARGO 191212, 191213, 191214.</i>			
		Length: 190 mm Height: 80 mm Width: 135 mm	Locking device: Mounting bracket Material/house: Plastic Material/lid: Aluminium Cable entries: 8 Waterproof: Yes Dust proof: Yes Connection block: No
191215 Junction Box	Std pkg 1		
<i>Cable entries and blind: HC-CARGO 191220, 191221, 191222, 191223. Connecting block: HC-CARGO 191212, 191213, 191214, 191218, 191219.</i>			
		Length: 151 mm Height: 55 mm Width: 93 mm	Locking device: Mounting bracket Material/house: Plastic Material/lid: Aluminium Cable entries: 5 Waterproof: Yes Dust proof: Yes Connection block: No
191216 Junction Box	Std pkg 1		
<i>Cable entries and blind: HC-CARGO 191220, 191221, 191222, 191223. Connecting block: HC-CARGO 191218, 191219.</i>			
		Length: 151 mm Height: 55 mm Width: 93 mm	Locking device: Mounting bracket Material/house: Plastic Material/lid: Aluminium Cable entries: 6 Waterproof: Yes Dust proof: Yes Connection block: No
191429 Junction Box	Std pkg 1		
		Length: 127 mm Height: 41 mm Width: 108 mm	Mount.: Screw Colour: Transparent Material/house: Rubber Material/lid: Plastic No./poles: 8 Cable entries: 4 Waterproof: Yes Dust proof: Yes
191507 Junction Box	Std pkg 1		
		Cable dim.: 6 mm ² Length: 125 mm Height: 25 mm Width: 73 mm	Mount.: Screw Material/house: Plastic No./poles: 6 Cable entries: 4 Waterproof: Yes Dust proof: Yes

EL. SPECIFICATIONS		DIMENSIONS	ADDITIONAL SPECIFICATIONS
191508	Junction Box Std pkg 1 	Cable dim.: 6 mm ² Length: 125 mm Height: 25 mm Width: 73 mm	Mount.: Screw Material/house: Plastic No./poles: 8 Cable entries: 4 Waterproof: Yes Dust proof: Yes
191510	Junction Box Std pkg 1 	Cable dim.: 6 mm ² Length: 125 mm Height: 25 mm Width: 73 mm	Type: Dual Mount.: Terminal Material/house: Plastic No./poles: 8 Cable entries: 4 Waterproof: Yes Dust proof: Yes
191755	Junction Box Std pkg 1 	Length: 105 mm Height: 66 mm Width: 105 mm	Colour: White Material/house: Plastic Waterproof: Yes Dust proof: Yes
191984	Junction Box Std pkg 1 <i>4 double 11 pole flat plug connection and 2 double 4 pole flat plug connection. w/ locking clamps or alternatively 4 screws.</i> 	Length: 167 mm Height: 99 mm Width: 157 mm	Mount.: Terminal Material/house: Plastic Cable entries: 16 Waterproof: Yes Protection degree: IP 65 ADR-approved: Yes GGVS approval: Yes
192218	Junction Box Std pkg 1 <i>Power junction box for cables up to 25 mm². Contains 2xM8 studs.</i> 		
ACCESSORIES			
191220	Cable Entries Std pkg 10 Servicing: HC-CARGO 191211, 191215, 191216 <i>O.D. 7 mm.</i> 		
191221	Cable Entries Std pkg 10 Servicing: HC-CARGO 191211, 191215, 191216 <i>O.D. 9.5 mm.</i> 		

EL. SPECIFICATIONS		DIMENSIONS		ADDITIONAL SPECIFICATIONS
191222	Cable Entries	Std pkg 10	Servicing: HC-CARGO 191211, 191215, 191216	
<i>O.D. 13 mm.</i>				
				
191223	Cable Entries	Std pkg 10	Servicing: HC-CARGO 191211, 191215, 191216	
				
BLOCK				
191212	Terminal Block	Std pkg 1	Servicing: HC-CARGO 191211, 191215, 191216	
				
				Type: Dual Mount.: Terminal No./poles: 14
191213	Terminal Block	Std pkg 1	Servicing: HC-CARGO 191211, 191215, 191216	
				
				Type: Dual Mount.: Terminal No./poles: 28
191214	Terminal Block	Std pkg 1	Servicing: HC-CARGO 191211, 191215, 191216	
<i>1 double 14-pole and 1 single 14-pole flat plug connection block.</i>				
				
				Type: Dual Mount.: Terminal No./poles: 14
191218	Terminal Block	Std pkg 1	Servicing: HC-CARGO 191215, 191216	
				
				Type: Dual Mount.: Terminal No./poles: 8
191219	Terminal Block	Std pkg 1	Servicing: HC-CARGO 191215, 191216	
<i>1 double 8-pole and 1 single 8-pole flat plug connection block.</i>				
				
				Type: Dual Mount.: Terminal No./poles: 8

191756 Butt Splices Std pkg 1

8x6 terminalblock. 25 A. Terminal width: 6.3 mm



Dist. mount. holes:
99 mm

Terminal type: Flat
Material: Polycarbonate
Out: 8
Plugs in: 8

191771 Butt Splices Std pkg 1

1x8 20 A.

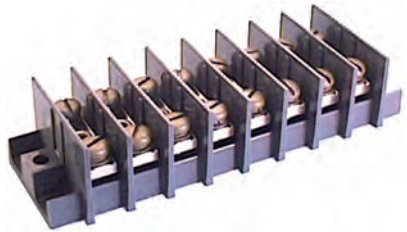

Dist. mount. holes:
99 mm

Terminal type: Screw
Material: Polycarbonate
Out: 8
Plugs in: 8

193011 Terminal Block Std pkg 1

25 A. Terminal width: 6.3 mm.

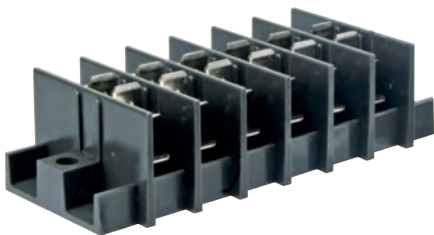

Dist. mount. holes:
77.3 mm

Terminal type: Flat
Material: Polycarbonate
Out: 6
Plugs in: 6







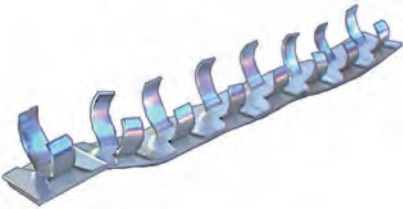

CABLE & WIRING

CABLE CLIPS

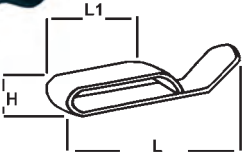
RUBBER-PROFILE

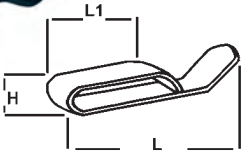

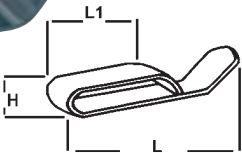
	HC-CARGO	Std pkg	Width	ID	Mount. hole size	Type	Material
	191666	Pkg. 10	12.7 mm	3.2 mm	6.8 mm	3	Rubber
	191667	Pkg. 10	12.7 mm	4.8 mm	6.8 mm	5	Rubber
	190899	Pkg. 10	12.7 mm	6.4 mm	6.8 mm	6	Rubber
	190900	Pkg. 10	12.7 mm	7.9 mm	6.8 mm	8	Rubber
	190901	Pkg. 10	12.7 mm	9.5 mm	6.8 mm	10	Rubber
	190902	Pkg. 10	12.7 mm	11.1 mm	6.8 mm	11	Rubber
	190903	Pkg. 10	12.7 mm	12.7 mm	6.8 mm	13	Rubber
	190904	Pkg. 10	12.7 mm	14.3 mm	6.8 mm	14	Rubber
	190905	Pkg. 10	12.7 mm	15.9 mm	6.8 mm	16	Rubber
	190906	Pkg. 10	12.7 mm	17.5 mm	6.8 mm	18	Rubber
	190907	Pkg. 10	12.7 mm	19 mm	6.8 mm	19	Rubber
	191668	Pkg. 10	12.7 mm	20.6 mm	6.8 mm	21	Rubber
	190908	Pkg. 10	12.7 mm	22.2 mm	6.8 mm	22	Rubber
	191669	Pkg. 10	12.7 mm	24 mm	6.8 mm	24	Rubber
	190909	Pkg. 10	12.7 mm	25.4 mm	6.8 mm	25	Rubber
	191417	Pkg. 10	12.7 mm	28.6 mm	6.8 mm	29	Rubber
	191992	Pkg. 10	12.7 mm	30.2 mm	6.8 mm	30	Rubber
	191994	Pkg. 10	12.7 mm	33.3 mm	6.8 mm	33	Rubber
	191553	Pkg. 10	12.7 mm	34.9 mm	6.8 mm	35	Rubber
	191996	Pkg. 10	12.7 mm	38.1 mm	6.8 mm	38	Rubber
	191997	Pkg. 10	12.7 mm	41 mm	6.8 mm	41	Rubber
	191998	Pkg. 10	12.7 mm	44.5 mm	6.8 mm	45	Rubber
	191814	Pkg. 10	12.7 mm	50.8 mm	6.8 mm	51	Rubber

SELF-ADHESIVE						
	HC-CARGO	Std pkg	Cable dia.			
	190962	Pkg. 100	10 mm	Self-adhesive.		
	190961	Pkg. 100	6 mm	Self-adhesive.		
BLACK PLASTIC						
	HC-CARGO	Std pkg	Length	ID	Mount. hole dia.	Colour
	191950	Pkg. 100	9.5 mm	3.2 mm	4.6 mm	Black
	191951	Pkg. 100	10.5 mm	4.8 mm	4.6 mm	Black
	191952	Pkg. 100	12 mm	6.4 mm	4.6 mm	Black
	191953	Pkg. 100	12 mm	7.9 mm	4.6 mm	Black
	191954	Pkg. 100	12.5 mm	9.5 mm	4.6 mm	Black
	191955	Pkg. 100	15.2 mm	12.7 mm	4.6 mm	Black
	191956	Pkg. 100	18.2 mm	15.8 mm	4.6 mm	Black
	191957	Pkg. 100	18.2 mm	19.4 mm	4.6 mm	Black
	191958	Pkg. 100	22 mm	25.4 mm	4.6 mm	Black
	191959	Pkg. 100	26.2 mm	31.8 mm	4.6 mm	Black
CHASSIS CLIPS						
191228 Chassis Clips Std pkg 100						
 			Length: 22 mm Total length: 43 mm Height: 7 mm			
191229 Chassis Clips Std pkg 100						
 			Length: 31 mm Total length: 52 mm Height: 7 mm			
193046 Chassis Clips Std pkg 100						
 			Length: 15.5 mm Total length: 28 mm Height: 6 mm			
PIPE CLIPS						
	HC-CARGO	Std pkg	Cable dia.	Length	Width	
	193256	Pkg. 100	3 mm	12 mm	7 mm	
	193257	Pkg. 100	5 mm	16 mm	12 mm	
	193258	Pkg. 100	7 mm	16 mm	12 mm	
	193259	Pkg. 100	8 mm	16 mm	12 mm	
	193260	Pkg. 100	10 mm	16 mm	12 mm	
	193261	Pkg. 100	12 mm	16 mm	14 mm	
	193262	Pkg. 100	15 mm	16 mm	14 mm	

CABLE TIES

BLACK

	HC-CARGO	Std pkg	Length	Width	ID	Colour	Material
	191128	Pkg. 100	92 mm	2.4 mm	16 mm	Black	Nylon 66
	191003	Pkg. 100	102 mm	2.5 mm	25 mm	Black	Nylon 66
	191939	Pkg. 100	140 mm	2.5 mm	44 mm	Black	Nylon 66
	190188	Pkg. 100	150 mm	3.6 mm	39 mm	Black	Nylon 66
	190248	Pkg. 100	190 mm	4.8 mm	52 mm	Black	Nylon 66
	191094	Pkg. 100	200 mm	2.5 mm	55 mm	Black	Nylon 66
	192112	Pkg. 100	240 mm	7.6 mm	66 mm	Black	Nylon 66
	192110	Pkg. 100	292 mm	3.6 mm	85 mm	Black	Nylon 66
	190011	Pkg. 100	310 mm	4.8 mm	89 mm	Black	Nylon 66
	190190	Pkg. 100	368 mm	4.8 mm	102 mm	Black	Nylon 66
	190189	Pkg. 100	380 mm	7.6 mm	110 mm	Black	Nylon 66
	192068	Pkg. 100	450 mm	4.8 mm	130 mm	Black	Nylon 66
	191776	Pkg. 100	550 mm	8 mm	166 mm	Black	Nylon 66
	192041	Pkg. 100	730 mm	12.7 mm	225 mm	Black	Nylon 66
	190191	Pkg. 100	762 mm	9 mm	236 mm	Black	Nylon 66
192111	Pkg. 100	812 mm	9 mm	246 mm	Black	Nylon 66	

MOUNTING

	HC-CARGO	Std pkg	Length	Width	ID	Mount. hole dia.
	192013	Pkg. 100	205 mm	4.2 mm	60 mm	4.8 mm
	192014	Pkg. 100	370 mm	4.8 mm	102 mm	4.8 mm
	192015	Pkg. 100	400 mm	7.9 mm	122 mm	4.8 mm

COLOURED

	HC-CARGO	Std pkg	Length	Width	ID	Colour
	192498	Pkg. 100	190 mm	4.8 mm	52 mm	White
	192497	Pkg. 100	190 mm	4.8 mm	52 mm	Yellow
	192496	Pkg. 100	190 mm	4.8 mm	52 mm	Green
	192495	Pkg. 100	190 mm	4.8 mm	52 mm	Blue
	192494	Pkg. 100	190 mm	4.8 mm	52 mm	Red

W/ LOCK

191943 Cable Tie Std pkg 100

Releasable w/ lock.



ID: 80 mm
Length: 300 mm
Width: 8 mm

Colour: Black

TIE MOUNT

190014 Tie Mount Std pkg 100



Dim.: 27x27 mm
Mount. hole dia.: 5 mm
Max width: 5 mm

Colour: Black
Material: Nylon 66
Self adhesive: Yes
Alternativ no.: 192997

191941 Tie Mount	Std pkg 100		Dim.: 12.9x17.8x6.6 mm Mount. hole dia.: 6.2 mm Max width: 8 mm	Colour: White Material: Nylon 66 Self adhesive: No
191960 Tie Mount	Std pkg 100		Dim.: 21x21 mm Mount. hole dia.: 5 mm Max width: 3.2 mm	Colour: Black Material: Nylon 66 Self adhesive: Yes
192489 Tie Mount	Std pkg 100		Dim.: 27x27 mm Cable dia.: 8 mm	Colour: White Material: Nylon 66 Self adhesive: Yes
192983 Tie Mount	Std pkg 100		Dim.: 38x38 mm Mount. hole dia.: 5 mm Max width: 10 mm	Colour: Black Material: Nylon 66 Self adhesive: Yes
192985 Tie Mount	Std pkg 100		Dim.: 23x16x10 mm Mount. hole dia.: 5 mm Max width: 12 mm	Colour: Black Material: Nylon Self adhesive: No
192997 Tie Mount	Std pkg 100		Dim.: 26.1x26.1 mm Mount. hole dia.: 4.3 mm Max width: 8 mm	Colour: Black Material: Nylon Self adhesive: Yes

CONNECTORS

	HC-CARGO	Std pkg	Size 1	Size 2	Size 3	Temp.	Colour	Material	Type
	193129	Pkg. 5	10 mm	10 mm	10 mm	-40 - +135 °C	Black	Polyamid	T
	193163	Pkg. 5	10 mm	10 mm	10 mm	-40 - +135 °C	Black	Polyamid	Y
	193130	Pkg. 5	13 mm	7.5 mm	13 mm	-40 - +135 °C	Black	Polyamid	T
	193131	Pkg. 5	13 mm	10 mm	13 mm	-40 - +135 °C	Black	Polyamid	T
	193151	Pkg. 5	13 mm	13 mm	13 mm	-40 - +135 °C	Black	Polyamid	T
	193135	Pkg. 5	17 mm	10 mm	17 mm	-40 - +135 °C	Black	Polyamid	T
	193212	Pkg. 5	17 mm	17 mm	17 mm	-40 - +135 °C	Black	Polyamid	T
193142	Pkg. 5	22 mm	13 mm	22 mm	-40 - +135 °C	Black	Polyamid	T	

FLEXIBLE CONVOLUTED TUBING

	HC-CARGO	Std pkg	ID	OD	Length	ISO Norm	Colour	Material
	193121	Pkg. 50	6.6 mm	10 mm	50 m	9772 9773	Black	Nylon 66
	193122	Pkg. 50	9.8 mm	13 mm	50 m	9772 9773	Black	Nylon 66
	193123	Pkg. 50	12.2 mm	15.8 mm	50 m	9772 9773	Black	Nylon 66
	193124	Pkg. 100	17.2 mm	20 mm	100 m		Black	Polypropylene
	193125	Pkg. 100	21.2 mm	25.8 mm	100 m		Black	Polypropylene
	193126	Pkg. 50	25 mm	30 mm	50 m		Black	Polypropylene
	193127	Pkg. 50	28 mm	34 mm	50 m		Black	Polypropylene

FLEXIBLE CONVOLUTED SPLIT TUBING

	HC-CARGO	Std pkg	HC-CARGO	Std pkg	ID	OD	Colour	Material
	191944	Pkg. 25	B191944	Pkg. 300	7.4 mm	10.2 mm	Black	Polypropylene
	191945	Pkg. 25	B191945	Pkg. 200	10.7 mm	16 mm	Black	Polypropylene
	191946	Pkg. 25	B191946	Pkg. 200	13.8 mm	17.5 mm	Black	Polypropylene
	191947	Pkg. 10	B191947	Pkg. 100	15 mm	19.5 mm	Black	Polypropylene
	191948	Pkg. 10	B191948	Pkg. 100	19.3 mm	23.8 mm	Black	Polypropylene
	191949	Pkg. 10	B191949	Pkg. 100	22 mm	27 mm	Black	Polypropylene
	192009	Pkg. 10	B192009	Pkg. 50	25 mm	30 mm	Black	Polypropylene
	192010	Pkg. 10	B192010	Pkg. 50	28 mm	34 mm	Black	Polypropylene

GLANDS

192355 Cable Gland

Std pkg 50



Cable dia.: 3.5 mm
ID: 6.9 mm
Mount. hole dia.: 12.1 mm
Length: 41.2 mm
Max width: 6 mm

Colour: Grey
Protection degree: IP 68

192356 Cable Gland

Std pkg 50



Cable dia.: 4 mm
ID: 8 mm
Mount. hole dia.: 14.3 mm
Length: 45 mm
Max width: 8 mm

Colour: Grey
Protection degree: IP 68

192357 Cable Gland

Std pkg 50



Cable dia.: 5 mm
ID: 10.5 mm
Mount. hole dia.: 18.23 mm
Length: 49.9 mm
Max width: 10 mm

Colour: Grey
Protection degree: IP 68

192358 Cable Gland

Std pkg 50



Cable dia.: 6 mm
ID: 12 mm
Mount. hole dia.: 19.9 mm
Length: 52.4 mm
Max width: 12 mm

Colour: Grey
Protection degree: IP 68

192359 Cable Gland

Std pkg 50



Cable dia.: 10 mm
ID: 14 mm
Mount. hole dia.: 22.1 mm
Length: 55.5 mm
Max width: 14 mm

Colour: Grey
Protection degree: IP 68

		EL. SPECIFICATIONS	DIMENSIONS	ADDITIONAL SPECIFICATIONS
192360	Cable Gland	Std pkg 50		
			Cable dia.: 13 mm ID: 18.4 mm Mount. hole dia.: 27.5 mm Length: 64.5 mm Max width: 18 mm	Colour: Grey Protection degree: IP 68
192479	Cable Gland	Std pkg 50		
			Cable dia.: 3 mm ID: 6.9 mm Mount. hole dia.: 12 mm Length: 41.7 mm Max width: 6.5 mm	Colour: Grey Protection degree: IP 68
192480	Cable Gland	Std pkg 50		
			Cable dia.: 5 mm ID: 10.5 mm Mount. hole dia.: 16 mm Length: 55.8 mm Max width: 10 mm	Colour: Grey Protection degree: IP 68
192481	Cable Gland	Std pkg 50		
			Cable dia.: 10 mm ID: 14 mm Mount. hole dia.: 20 mm Length: 62 mm Max width: 14 mm	Colour: Grey Protection degree: IP 68
192482	Cable Gland	Std pkg 50		
			Cable dia.: 13 mm ID: 18.4 mm Mount. hole dia.: 25 mm Length: 66.9 mm Max width: 18 mm	Colour: Grey Protection degree: IP 68
192483	Cable Gland	Std pkg 25		
			Cable dia.: 18 mm ID: 25 mm Mount. hole dia.: 32 mm Length: 74.9 mm Max width: 25 mm	Colour: Grey Protection degree: IP 68

GROMMET

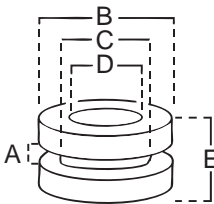
	HC-CARGO	Std pkg	A	B	C	D	E	Colour	Material
 	190964	Pkg. 100	1.6 mm	11.1 mm	7.9 mm	5.6 mm	6.4 mm	Black	PVC
	190120	Pkg. 100	1.6 mm	14.2 mm	9.5 mm	6.4 mm	5 mm	Black	PVC
	190965	Pkg. 100	1.6 mm	14.2 mm	9.5 mm	8 mm	4.8 mm	Black	PVC
	190966	Pkg. 100	1.6 mm	14.2 mm	11 mm	8 mm	4.8 mm	Black	PVC
	190967	Pkg. 100	1.6 mm	16 mm	11 mm	8 mm	6.4 mm	Black	PVC
	192138	Pkg. 100	3 mm	16 mm	12.5 mm	8 mm	8 mm	Black	PVC
	190122	Pkg. 100	1.6 mm	17 mm	12.5 mm	9.5 mm	7 mm	Black	PVC
	190968	Pkg. 100	1.6 mm	19 mm	14.2 mm	11 mm	6.4 mm	Black	PVC
	190969	Pkg. 100	1.6 mm	22 mm	17.5 mm	12.5 mm	6.4 mm	Black	PVC
	190970	Pkg. 100	1.6 mm	25.5 mm	19 mm	12.5 mm	6.4 mm	Black	PVC
	192139	Pkg. 100	3 mm	30 mm	24 mm	16 mm	11 mm	Black	PVC

END PLUG

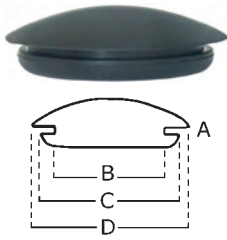

HC-CARGO	Std pkg	A	B	C	D	Colour	Material
190114	Pkg. 100	1.6 mm	12.5 mm	15.5 mm	18.7 mm	Black	PVC
190115	Pkg. 100	1.6 mm	15.5 mm	19 mm	22 mm	Black	PVC
190116	Pkg. 100	1.6 mm	19 mm	22.1 mm	25.5 mm	Black	PVC
190958	Pkg. 100	1.6 mm	22.5 mm	27 mm	28.5 mm	Black	PVC
190959	Pkg. 100	1.6 mm	25.4 mm	28.3 mm	32 mm	Black	PVC
190110	Pkg. 100	1.6 mm	6.4 mm	9.5 mm	9.5 mm	Black	PVC
190111	Pkg. 100	1.6 mm	8 mm	10.6 mm	14.2 mm	Black	PVC
190112	Pkg. 100	1.6 mm	9.5 mm	12.8 mm	15.4 mm	Black	PVC

POLYURETHAN WIRE SLEEVING



HC-CARGO	Std pkg	Voltage	ID	Length	Temp.resist-ant	Thermal class.	Colour
191380	Pkg. 1	4000	1 mm	1 m	+155 C°	F	Nature
B191380	Pkg. 200	4000	1 mm	200 m	+155 C°	F	Nature
191383	Pkg. 1	4000	2.5 mm	1 m	+155 C°	F	Nature
B191383	Pkg. 100	4000	2.5 mm	200 m	+155 C°	F	Nature
B191382	Pkg. 200	4000	2 mm	200 m	+155 C°	F	Nature
B191384	Pkg. 100	4000	3 mm	100 m	+155 C°	F	Nature
191384	Pkg. 1	4000	3 mm	1 m	+155 C°	F	Nature
B191385	Pkg. 100	4000	4 mm	100 m	+155 C°	F	Nature
B191387	Pkg. 100	4000	6 mm	100 m	+155 C°	F	Nature
191387	Pkg. 1	4000	6 mm	1 m	+155 C°	F	Nature
B191494	Pkg. 100	4000	8 mm	100 m	+155 C°	F	Nature
191494	Pkg. 1	4000	8 mm	1 m	+155 C°	F	Nature

PVC SLEEVINGS



HC-CARGO	Std pkg	Cable dim.	Colour	Material
190175	Pkg. 100	4 mm	Black	PVC
191388	Pkg. 100	5 mm	Black	PVC
190176	Pkg. 100	6 mm	Black	PVC
190177	Pkg. 100	8 mm	Black	PVC
190178	Pkg. 50	10 mm	Black	PVC
190179	Pkg. 50	12 mm	Black	PVC

SPIRAL BINDINGS



HC-CARGO	Std pkg	Recommended loom	Length	Temp	Colour
191881	Pkg. 50	2 mm - 10 mm	50 m	-50 - +85 °C	Black
191882	Pkg. 25	5 mm - 40 mm	25 m	-50 - +85 °C	Black
191883	Pkg. 25	10 mm - 50 mm	25 m	-50 - +85 °C	Black

HEAT SHRINK TUBING

BLACK



HC-CARGO	Std pkg	Crimp ratio	Crimp temp.	Before crimp	After crimp	Length	Dim.	Packaging	Colour
193169	Pkg. 1	2:1	90 C°	1.6 mm	0.8 mm	10 m	16x16x5 cm	Minibox	Black
193170	Pkg. 1	2:1	90 C°	2.4 mm	1.2 mm	10 m	16x16x5 cm	Minibox	Black
193171	Pkg. 1	2:1	90 C°	3.2 mm	1.6 mm	10 m	16x16x5 cm	Minibox	Black
193172	Pkg. 1	2:1	90 C°	4.8 mm	2.4 mm	8 m	16x16x5 cm	Minibox	Black
193173	Pkg. 1	2:1	90 C°	6.4 mm	3.2 mm	6 m	16x16x5 cm	Minibox	Black
193174	Pkg. 1	2:1	90 C°	9.5 mm	4.7 mm	5 m	16x16x5 cm	Minibox	Black
193175	Pkg. 1	2:1	90 C°	12.7 mm	6.4 mm	5 m	16x16x5 cm	Minibox	Black
193176	Pkg. 1	2:1	90 C°	19.1 mm	9.5 mm	4 m	16x16x5 cm	Minibox	Black
193177	Pkg. 1	2:1	90 C°	25.4 mm	12.7 mm	3 m	16x16x5 cm	Minibox	Black
193178	Pkg. 1	2:1	90 C°	31.8 mm	15.9 mm	1 m		Plastic bag	Black
193179	Pkg. 1	2:1	90 C°	38.1 mm	19.1 mm	1 m		Plastic bag	Black
193180	Pkg. 1	2:1	90 C°	50.8 mm	25.4 mm	1 m		Plastic bag	Black

RED										
	HC-CARGO	Std pkg	Crimp ratio	Crimp temp.	Before crimp	After crimp	Length	Dim.	Packaging	Colour
	193181	Pkg. 1	2:1	90 C°	3.2 mm	1.6 mm	10 m	16x16x5 cm	Minibox	Red
	193182	Pkg. 1	2:1	90 C°	4.8 mm	2.4 mm	8 m	16x16x5 cm	Minibox	Red
	193183	Pkg. 1	2:1	90 C°	6.4 mm	3.2 mm	6 m	16x16x5 cm	Minibox	Red
	193184	Pkg. 1	2:1	90 C°	9.5 mm	4.7 mm	5 m	16x16x5 cm	Minibox	Red
	193185	Pkg. 1	2:1	90 C°	12.7 mm	6.4 mm	5 m	16x16x5 cm	Minibox	Red
	193186	Pkg. 1	2:1	90 C°	19.1 mm	9.5 mm	4 m	16x16x5 cm	Minibox	Red
	193187	Pkg. 1	2:1	90 C°	25.4 mm	12.7 mm	3 m	16x16x5 cm	Minibox	Red
	193188	Pkg. 1	2:1	90 C°	31.8 mm	15.9 mm	1 m		Plastic bag	Red
	193189	Pkg. 1	2:1	90 C°	38.1 mm	19.1 mm	1 m		Plastic bag	Red
	193190	Pkg. 1	2:1	90 C°	50.8 mm	25.4 mm	1 m		Plastic bag	Red
BLACK - BLISTER PACK										
	HC-CARGO	Std pkg	Crimp ratio	Crimp temp.	Before crimp	After crimp	Length	Dim.	Packaging	Colour
	193003	Pkg. 1	2:1	110 C°	2.4 mm	1.2 mm	2 m		Blister pack	Black
	193004	Pkg. 1	2:1	110 C°	3.2 mm	1.6 mm	2 m		Blister pack	Black
	193005	Pkg. 1	2:1	110 C°	4.8 mm	2.4 mm	2 m		Blister pack	Black
	193006	Pkg. 1	2:1	110 C°	6.4 mm	3.2 mm	2 m		Blister pack	Black
	193007	Pkg. 1	2:1	110 C°	9.5 mm	4.8 mm	2 m		Blister pack	Black
	193008	Pkg. 1	2:1	110 C°	12.7 mm	6.4 mm	2 m		Blister pack	Black
	193009	Pkg. 1	2:1	110 C°	19 mm	9.5 mm	2 m		Blister pack	Black
	BLACK W/ GLUE									
	HC-CARGO	Std pkg	Crimp ratio	Crimp temp.	Before crimp	After crimp	Length	Dim.	Packaging	Colour
	193197	Pkg. 1	3:1	100 C°	3 mm	1 mm	5 m	16x16x5 cm	Minibox	Black
	193191	Pkg. 5	3:1	100 C°	3 mm	1 mm	5x0.2 m		Plastic bag	Black
	193198	Pkg. 1	3:1	100 C°	6 mm	2 mm	3.5 m	16x16x5 cm	Minibox	Black
	193192	Pkg. 5	3:1	100 C°	6 mm	2 mm	5x0.2 m		Plastic bag	Black
	193199	Pkg. 1	3:1	100 C°	9 mm	3 mm	3 m	16x16x5 cm	Minibox	Black
	193193	Pkg. 5	3:1	100 C°	9 mm	3 mm	5x0.2 m		Plastic bag	Black
	193200	Pkg. 1	3:1	100 C°	12 mm	4 mm	2.5 m	16x16x5 cm	Minibox	Black
	193194	Pkg. 5	3:1	100 C°	12 mm	4 mm	5x0.2 m		Plastic bag	Black
	193201	Pkg. 1	3:1	100 C°	18 mm	6 mm	2 m	16x16x5 cm	Minibox	Black
	193195	Pkg. 5	3:1	100 C°	18 mm	6 mm	5x0.2 m		Plastic bag	Black
	193202	Pkg. 1	3:1	100 C°	24 mm	8 mm	1.5 m	16x16x5 cm	Minibox	Black
	193196	Pkg. 5	3:1	100 C°	24 mm	8 mm	5x0.2 m		Plastic bag	Black
	193203	Pkg. 1	3:1	100 C°	39 mm	13 mm	1 m		Plastic bag	Black
	193204	Pkg. 1	4:1	100 C°	52 mm	13 mm	1 m		Plastic bag	Black
	RED W/ GLUE									
	HC-CARGO	Std pkg	Crimp ratio	Crimp temp.	Before crimp	After crimp	Length	Dim.	Packaging	Colour
	193205	Pkg. 1	3:1	100 C°	3 mm	1 mm	5 m	16x16x5 cm	Minibox	Red
	193206	Pkg. 1	3:1	100 C°	6 mm	2 mm	3.5 m	16x16x5 cm	Minibox	Red
	193207	Pkg. 1	3:1	100 C°	9 mm	3 mm	3 m	16x16x5 cm	Minibox	Red
	193208	Pkg. 1	3:1	100 C°	12 mm	4 mm	2.5 m	16x16x5 cm	Minibox	Red
	193209	Pkg. 1	3:1	100 C°	18 mm	6 mm	2 m	16x16x5 cm	Minibox	Red
	193210	Pkg. 1	3:1	100 C°	24 mm	8 mm	1.5 m	16x16x5 cm	Minibox	Red
	193211	Pkg. 1	3:1	100 C°	39 mm	13 mm	1.22 m		Plastic bag	Red

TOOLS

CABLE CUTTER

211096 Cable Cutter Std pkg 1

Cutting size O.D. 50 mm².



CABLE STRIPPER

210828 Cable Stripper Std pkg 1

Self-adjusting.



Cable dia.: 0.5-8 mm
Max width: 5 mm

CABLE TIE GUNS

210827 Cable Tie Gun Std pkg 1

Professional, adjustable, fasten and cut ties automatically.



Cable dia.: 2.5-5 mm
Max width: 4.8 mm

210849 Cable Tie Gun Std pkg 1

Professional, adjustable, fasten and cut ties automatically.



Cable dia.: 2.5-10 mm
Max width: 10 mm

BUSHES

210644 Dismounting Bushes Std pkg 1 Servicing: HC-CARGO 210643



OD: 6.5 mm

210645 Contact Insertion Sleeve Std pkg 1 Servicing: HC-CARGO 210643



Dim.: 6.5 mm²

CABLES

SINGLE CORE

0.5 MM²

HC-CARGO	Voltage	Amp	Conductor dim.	OD	Temp. area	Insulator	Colour	Material	Min supply
191936	300/500	5	16/0.195 mm	2.5 mm	70 °C	Unleaded PVC	Grey	PVC	100 m
191930	300/500	5	16/0.195 mm	2.5 mm	70 °C	Unleaded PVC	Brown	PVC	100 m

0.75 MM²

HC-CARGO	Voltage	Amp	Conductor dim.	OD	Temp. area	Insulator	Colour	Material	Min supply
192288	100	6	24/0.19 mm	2 mm	-40 - +100 °C	ISO 6722, Class B	White/red	PVC	100 m
192287	100	6	24/0.19 mm	2 mm	-40 - +100 °C	ISO 6722, Class B	White/yellow	PVC	100 m
192286	100	6	24/0.19 mm	2 mm	-40 - +100 °C	ISO 6722, Class B	White/green	PVC	100 m
192284	100	6	24/0.19 mm	2 mm	-40 - +100 °C	ISO 6722, Class B	White/blue	PVC	100 m
192283	100	6	24/0.19 mm	2 mm	-40 - +100 °C	ISO 6722, Class B	Black/yellow	PVC	100 m
192282	100	6	24/0.19 mm	2 mm	-40 - +100 °C	ISO 6722, Class B	Blue/green	PVC	100 m
192280	100	6	24/0.19 mm	2 mm	-40 - +100 °C	ISO 6722, Class B	Black/white	PVC	100 m
192279	100	6	24/0.19 mm	2 mm	-40 - +100 °C	ISO 6722, Class B	Grey/red	PVC	100 m
192278	100	6	24/0.19 mm	2 mm	-40 - +100 °C	ISO 6722, Class B	Yellow/green	PVC	100 m
192277	100	6	24/0.19 mm	2 mm	-40 - +100 °C	ISO 6722, Class B	Red/yellow	PVC	100 m
192276	100	6	24/0.19 mm	2 mm	-40 - +100 °C	ISO 6722, Class B	Red/Blue	PVC	100 m
192275	100	6	24/0.19 mm	2 mm	-40 - +100 °C	ISO 6722, Class B	Red/black	PVC	100 m
191402	300/500	6	24/0.195 mm	2.7 mm	70 °C	Unleaded PVC	Purple	PVC	100 m
191403	300/500	10	24/0.195 mm	2.7 mm	70 °C	Unleaded PVC	Orange	PVC	100 m
193253	300/500	10	24/0.195 mm	2.7 mm	70 °C	Unleaded PVC	Brown	PVC	100 m
191401	50	10	24/0.195 mm	2.8 mm	70 °C	Unleaded PVC	Grey	PVC	100 m
191400	50	10	24/0.195 mm	2.8 mm	70 °C	Unleaded PVC	Red	PVC	100 m
191399	50	10	24/0.195 mm	2.8 mm	70 °C	Unleaded PVC	White	PVC	100 m
191398	50	10	24/0.195 mm	2.8 mm	70 °C	Unleaded PVC	Yellow	PVC	100 m
191397	50	10	24/0.195 mm	2.8 mm	70 °C	Unleaded PVC	Green	PVC	100 m
191396	50	10	24/0.195 mm	2.8 mm	70 °C	Unleaded PVC	Brown	PVC	100 m
191395	50	10	24/0.195 mm	2.8 mm	70 °C	Unleaded PVC	Blue	PVC	100 m
190674	50	10	24/0.195 mm	2.8 mm	70 °C	Unleaded PVC	Black	PVC	100 m

1 MM²

HC-CARGO	Voltage	Amp	Conductor dim.	OD	Temp. area	Insulator	Colour	Material	Min supply
190987	50	10	32/0.195 mm	2.8 mm	70 °C	Unleaded PVC	Yellow	PVC	100 m
190988	50	10	32/0.195 mm	2.8 mm	70 °C	Unleaded PVC	Green	PVC	100 m
191090	50	10	32/0.195 mm	2.8 mm	70 °C	Unleaded PVC	Grey	PVC	100 m
191404	50	10	32/0.195 mm	2.8 mm	70 °C	Unleaded PVC	Purple	PVC	100 m

1 MM², H05V-K

HC-CARGO	Voltage	Amp	Conductor dim.	OD	Temp. area	Insulator	Colour	Material	Min supply
190986	300/500	14	32/0.195 mm	2.8 mm	70 °C	Unleaded PVC	Black	PVC	100 m
190990	300/500	14	32/0.195 mm	2.8 mm	70 °C	Unleaded PVC	Red	PVC	100 m
190991	300/500	14	32/0.195 mm	2.8 mm	70 °C	Unleaded PVC	White	PVC	100 m
190992	300/500	14	32/0.195 mm	2.8 mm	70 °C	Unleaded PVC	Brown	PVC	100 m
190989	300/500	14	32/0.195 mm	2.8 mm	70 °C	Unleaded PVC	Blue	PVC	100 m

1.5 MM²

HC-CARGO	Voltage	Amp	Conductor dim.	OD	Temp. area	Insulator	Colour	Material	Min supply
192289	50	16	30/0.250 mm	2.22 mm	70 °C	Unleaded PVC	Orange	PVC	100 m
192273	100	16	27-30/0.25 mm	2.7 mm	-40 - +100 °C	ISO 6722, Class B	White/orange	PVC R2G4	100 m
191176	100	16	27-30/0.25 mm	2.7 mm	-40 - +100 °C	ISO 6722, Class B	White/red	PVC R2G4	100 m
191177	100	16	27-30/0.25 mm	2.7 mm	-40 - +100 °C	ISO 6722, Class B	Yellow/blue	PVC R2G4	100 m
191178	100	16	27-30/0.25 mm	2.7 mm	-40 - +100 °C	ISO 6722, Class B	Brown/blue	PVC R2G4	100 m
192259	100	16	27-30/0.25 mm	2.7 mm	-40 - +100 °C	ISO 6722, Class B	Yellow/black	PVC R2G4	100 m
192260	100	16	27-30/0.25 mm	2.7 mm	-40 - +100 °C	ISO 6722, Class B	Red/Blue	PVC R2G4	100 m
192261	100	16	27-30/0.25 mm	2.7 mm	-40 - +100 °C	ISO 6722, Class B	Green/red	PVC R2G4	100 m
192262	100	16	27-30/0.25 mm	2.7 mm	-40 - +100 °C	ISO 6722, Class B	Grey/red	PVC R2G4	100 m
192263	100	16	27-30/0.25 mm	2.7 mm	-40 - +100 °C	ISO 6722, Class B	White/blue	PVC R2G4	100 m

HC-CARGO	Voltage	Amp	Conductor dim.	OD	Temp. area	Insulator	Colour	Material	Min supply
192264	100	16	27-30/0.25 mm	2.7 mm	-40 - +100 °C	ISO 6722, Class B	Green/yellow	PVC R2G4	100 m
192265	100	16	27-30/0.25 mm	2.7 mm	-40 - +100 °C	ISO 6722, Class B	Brown/black	PVC R2G4	100 m
192267	100	16	27-30/0.25 mm	2.7 mm	-40 - +100 °C	ISO 6722, Class B	Black/red	PVC R2G4	100 m
192269	100	16	27-30/0.25 mm	2.7 mm	-40 - +100 °C	ISO 6722, Class B	Black/green	PVC R2G4	100 m
192270	100	16	27-30/0.25 mm	2.7 mm	-40 - +100 °C	ISO 6722, Class B	Black/blue	PVC R2G4	100 m
192271	100	16	27-30/0.25 mm	2.7 mm	-40 - +100 °C	ISO 6722, Class B	Black/orange	PVC R2G4	100 m
192272	100	16	27-30/0.25 mm	2.7 mm	-40 - +100 °C	ISO 6722, Class B	White/black	PVC R2G4	100 m
192274	100	16	27-30/0.25 mm	2.7 mm	-40 - +100 °C	ISO 6722, Class B	White/green	PVC R2G4	100 m
190696	50	18	30/0.250 mm	3 mm	70 °C	Unleaded PVC	White	PVC	100 m
190697	50	18	30/0.250 mm	3 mm	70 °C	Unleaded PVC	Black	PVC	100 m
190698	50	18	30/0.250 mm	3 mm	70 °C	Unleaded PVC	Red	PVC	100 m
190699	50	18	30/0.250 mm	3 mm	70 °C	Unleaded PVC	Blue	PVC	100 m
190700	50	18	30/0.250 mm	3 mm	70 °C	Unleaded PVC	Yellow	PVC	100 m
190701	50	18	30/0.250 mm	3 mm	70 °C	Unleaded PVC	Grey	PVC	100 m
190702	50	18	30/0.250 mm	3 mm	70 °C	Unleaded PVC	Green	PVC	100 m
190847	50	18	30/0.250 mm	3 mm	70 °C	Unleaded PVC	Brown	PVC	100 m
193255	450/750	16	30/0.250 mm	3 mm	70 °C	Unleaded PVC	Black	PVC	100 m

2.5 MM²

HC-CARGO	Voltage	Amp	Conductor dim.	OD	Temp. area	Insulator	Colour	Material	Min supply
190703	50	24	50/0.250 mm	3.5 mm	70 °C	Unleaded PVC	Black	PVC	50 m
190704	50	24	50/0.250 mm	3.5 mm	70 °C	Unleaded PVC	Red	PVC	50 m
190705	50	24	50/0.250 mm	3.5 mm	70 °C	Unleaded PVC	Blue	PVC	50 m
190706	50	24	50/0.250 mm	3.5 mm	70 °C	Unleaded PVC	Yellow	PVC	50 m
190910	50	24	50/0.250 mm	3.5 mm	70 °C	Unleaded PVC	Brown	PVC	50 m
190972	50	24	50/0.250 mm	3.5 mm	70 °C	Unleaded PVC	White	PVC	50 m
190707	450/750	25	50/0.250 mm	3.7 mm	70 °C	Unleaded PVC	Grey	PVC	100 m
190708	450/750	25	50/0.250 mm	3.7 mm	70 °C	Unleaded PVC	Green	PVC	100 m
193251	450/750	25	50/0.250 mm	3.7 mm	70 °C	Unleaded PVC	Black	PVC	100 m
193252	450/750	25	50/0.250 mm	3.7 mm	70 °C	Unleaded PVC	Red	PVC	100 m

4 MM²

HC-CARGO	Voltage	Amp	Conductor dim.	OD	Temp. area	Insulator	Colour	Material	Min supply
193254	450/750	28	48/ 0.310 mm	4.3 mm	70 °C	Unleaded PVC	Black	PVC	50 m
190677	50	32	48/ 0.310 mm	4.8 mm	70 °C	Unleaded PVC	Black	PVC	50 m
190951	50	32	48/ 0.310 mm	4.8 mm	70 °C	Unleaded PVC	Red	PVC	50 m

6 MM²

HC-CARGO	Voltage	Amp	Conductor dim.	OD	Temp. area	Insulator	Colour	Material	Min supply
191175	450/750	36	72/0.380 mm	4.8 mm	70 °C	Unleaded PVC	Brown	PVC	100 m
190678	50	41	72/0.310 mm	6.3 mm	70 °C	Unleaded PVC	Black	PVC	50 m
191027	50	41	72/0.310 mm	6.3 mm	70 °C	Unleaded PVC	Red	PVC	50 m

THIN WALL

FLRY-B 0.35 MM²

HC-CARGO	Voltage	Amp	Conductor dim.	OD	Temp. area	Insulator	Colour	Material	Min supply
193012	100	7	11-12/0.19 mm	1.6 mm	-40 - +100 °C	ISO 6722, Class B	Black	PVC	100 m
193013	100	7	11-12/0.19 mm	1.6 mm	-40 - +100 °C	ISO 6722, Class B	Red	PVC	100 m

FLRY-B 0.5 MM²

HC-CARGO	Voltage	Amp	Conductor dim.	OD	Temp. area	Insulator	Colour	Material	Min supply
193014	100	11	15-16/0.19 mm	1.6 mm	-40 - +100 °C	ISO 6722, Class B	Black	PVC	100 m
193015	100	11	15-16/0.19 mm	1.6 mm	-40 - +100 °C	ISO 6722, Class B	Red	PVC	100 m
193047	60	11	16/0.21 mm	1.6 mm	-40 - +100 °C	Unleaded PVC	Brown	PVC	100 m
193048	60	11	16/0.21 mm	1.6 mm	-40 - +100 °C	Unleaded PVC	Green	PVC	100 m
193049	60	11	16/0.21 mm	1.6 mm	-40 - +100 °C	Unleaded PVC	White	PVC	100 m
193050	60	11	16/0.21 mm	1.6 mm	-40 - +100 °C	Unleaded PVC	Grey	PVC	100 m
193051	60	11	16/0.21 mm	1.6 mm	-40 - +100 °C	Unleaded PVC	Blue	PVC	100 m
193052	60	11	16/0.21 mm	1.6 mm	-40 - +100 °C	Unleaded PVC	Yellow	PVC	100 m

FLRY-B 0.75 MM ²									
HC-CARGO	Voltage	Amp	Conductor dim.	OD	Temp. area	Insulator	Colour	Material	Min supply
193053	60	14	24/0.21 mm	1.9 mm	-40 - +100 °C	Unleaded PVC	Blue	PVC	100 m
193054	60	14	24/0.21 mm	1.9 mm	-40 - +100 °C	Unleaded PVC	Brown	PVC	100 m
193055	60	14	24/0.21 mm	1.9 mm	-40 - +100 °C	Unleaded PVC	Green	PVC	100 m
193056	60	14	24/0.21 mm	1.9 mm	-40 - +100 °C	Unleaded PVC	Yellow	PVC	100 m
193057	60	14	24/0.21 mm	1.9 mm	-40 - +100 °C	Unleaded PVC	White	PVC	100 m
193058	60	14	24/0.21 mm	1.9 mm	-40 - +100 °C	Unleaded PVC	Red	PVC	100 m
193059	60	14	24/0.21 mm	1.9 mm	-40 - +100 °C	Unleaded PVC	Black	PVC	100 m
193060	60	14	24/0.21 mm	1.9 mm	-40 - +100 °C	Unleaded PVC	Grey	PVC	100 m
FLRY-B 1 MM ²									
HC-CARGO	Voltage	Amp	Conductor dim.	OD	Temp. area	Insulator	Colour	Material	Min supply
193068	60	16.5	32/0.210 mm	2.1 mm	-40 - +100 °C	Unleaded PVC	Grey	PVC	100 m
193061	60	16.5	32/0.210 mm	2.1 mm	-40 - +100 °C	Unleaded PVC	Blue	PVC	100 m
193062	60	16.5	32/0.210 mm	2.1 mm	-40 - +100 °C	Unleaded PVC	Brown	PVC	100 m
193063	60	16.5	32/0.210 mm	2.1 mm	-40 - +100 °C	Unleaded PVC	Green	PVC	100 m
193064	60	16.5	32/0.210 mm	2.1 mm	-40 - +100 °C	Unleaded PVC	Yellow	PVC	100 m
193065	60	16.5	32/0.210 mm	2.1 mm	-40 - +100 °C	Unleaded PVC	White	PVC	100 m
193066	60	16.5	32/0.210 mm	2.1 mm	-40 - +100 °C	Unleaded PVC	Red	PVC	100 m
193067	60	16.5	32/0.210 mm	2.1 mm	-40 - +100 °C	Unleaded PVC	Black	PVC	100 m
FLRY-B 1.5 MM ²									
HC-CARGO	Voltage	Amp	Conductor dim.	OD	Temp. area	Insulator	Colour	Material	Min supply
193072	60	21	30/0.26 mm	2.4 mm	-40 - +100 °C	Unleaded PVC	Yellow	PVC	50 m
193073	60	21	30/0.26 mm	2.4 mm	-40 - +100 °C	Unleaded PVC	White	PVC	50 m
193074	60	21	30/0.26 mm	2.4 mm	-40 - +100 °C	Unleaded PVC	Red	PVC	50 m
193075	60	21	30/0.26 mm	2.4 mm	-40 - +100 °C	Unleaded PVC	Grey	PVC	50 m
193076	60	21	30/0.26 mm	2.4 mm	-40 - +100 °C	Unleaded PVC	Black	PVC	50 m
193069	60	21	30/0.26 mm	2.4 mm	-40 - +100 °C	Unleaded PVC	Blue	PVC	50 m
193070	60	21	30/0.26 mm	2.4 mm	-40 - +100 °C	Unleaded PVC	Brown	PVC	50 m
193071	60	21	30/0.26 mm	2.4 mm	-40 - +100 °C	Unleaded PVC	Green	PVC	50 m
FLRY-B 2 MM ²									
HC-CARGO	Voltage	Amp	Conductor dim.	OD	Temp. area	Insulator	Colour	Material	Min supply
193077	60	25	28/0.31 mm	2.8 mm	-40 - +100 °C	Unleaded PVC	Blue	PVC	50 m
193080	60	25	28/0.31 mm	2.8 mm	-40 - +100 °C	Unleaded PVC	Yellow	PVC	50 m
193081	60	25	28/0.31 mm	2.8 mm	-40 - +100 °C	Unleaded PVC	White	PVC	50 m
193082	60	25	28/0.31 mm	2.8 mm	-40 - +100 °C	Unleaded PVC	Red	PVC	50 m
193083	60	25	28/0.31 mm	2.8 mm	-40 - +100 °C	Unleaded PVC	Grey	PVC	50 m
193084	60	25	28/0.31 mm	2.8 mm	-40 - +100 °C	Unleaded PVC	Black	PVC	50 m
FLRY-B 4 MM ²									
HC-CARGO	Voltage	Amp	Conductor dim.	OD	Temp. area	Insulator	Colour	Material	Min supply
193085	60	39	56/0.31 mm	3.7 mm	-40 - +100 °C	Unleaded PVC	Red	PVC	50 m
193086	60	39	56/0.31 mm	3.7 mm	-40 - +100 °C	Unleaded PVC	Black	PVC	50 m
193087	60	39	56/0.31 mm	3.7 mm	-40 - +100 °C	Unleaded PVC	Brown	PVC	50 m
FLRY-B 6 MM ²									
HC-CARGO	Voltage	Amp	Conductor dim.	OD	Temp. area	Insulator	Colour	Material	Min supply
193088	60	50	84/0.31 mm	4.3 mm	-40 - +100 °C	Unleaded PVC	Red	PVC	50 m
193089	60	50	84/0.31 mm	4.3 mm	-40 - +100 °C	Unleaded PVC	Black	PVC	50 m
193090	60	50	84/0.31 mm	4.3 mm	-40 - +100 °C	Unleaded PVC	Brown	PVC	50 m
DOUBLE INSULATED									
1.5 MM ²									
HC-CARGO	Voltage	Amp	Conductor dim.	OD	Temp. area	Insulator	Colour	Material	Min supply
190954	50	16	30/0.250 mm	4 mm	70 °C	Unleaded PVC	Black	PVC	100 m
190948	50	16	30/0.250 mm	4 mm	70 °C	Unleaded PVC	Black	PVC	100 m
2.5 MM ²									
HC-CARGO	Voltage	Amp	Conductor dim.	OD	Temp. area	Insulator	Colour	Material	Min supply
191002	50	25	50/0.250 mm	4.2 mm	70 °C	Unleaded PVC	Black	PVC	100 m

SINGLE CORE SILICONE

HC-CARGO	Voltage	Amp	Conductor dim.	OD	Temp. area	Insulator	Colour	Material	Min supply
191923	50	16	392/0.07 mm	2.7 mm	-50 - +180 °C	Silicone	Black	Silicone	50 m
191924	50	16	392/0.07 mm	2.8 mm	-50 - +180 °C	Silicone	Red	Silicone	50 m

TRAILFLEX ADR

HC-CARGO	Voltage	Amp	No./core	Conductor dim.	OD	Insulator	Colour	Min supply
----------	---------	-----	----------	----------------	----	-----------	--------	------------

- TÜV Approved for ADR Applications.
- Specially developed and approved durable dual sheath construction.
- Cores insulated to a minimum of ISO 6722.
- Polyurethane sheathing ensures resistance to diesel oil, lerosene, dilute acids and alkalis.
- Excellent short-term dielectric strength (upto 3KV).

192093	50	10	2x1 mm ²	27/0.210 mm	6 mm	ISO 6722	White/brown	50 m
B192093	50	10	2x1 mm ²	27/0.210 mm	6 mm	ISO 6722	White/brown	3000 m
192096	50	12/24	5x3x1.5+2x4 mm ²	19/0.31+48/0.31 mm	12.1 mm	ISO 6722	Red/brown/black/ yellow/white	50 m
192227	50	10/24	7x3x1.5+2x4+(2x1.5) mm ²	19/0.31+48/0.31 mm	13.3 mm	ISO 7638	Red/brown/black/white/ white-green/white- brown	50 m
192099	50	10/16	7x6x1.5+1x2.5 mm ²	30/0.250+50/0.250 mm	10.3 mm	ISO 6722	White/black/yellow/red/ green/brown/blue	50 m
192102	50	8/12.5	15x10x1.5+3x2.5 +1x(2x1.5) mm ²	30/0.250+50/0.250 mm	14.4 mm	ISO 12098	White/orange/white- red/yellow/lightgreen/ blue/black/red/pink/ grey/white-black/white- lightgreen/white-blue/ white-brown/brown	50 m

LOUDSPEAKER

HC-CARGO	Voltage	Amp	No./core	Conductor dim.	OD	Temp. area	Colour	Min supply
190710	50	3	2x0.38 mm ²	12/0.200 mm	1.9x4.1 mm	70 °C	Blue/grey	100 m
191777	50	3	2x0.38 mm ²	12/0.200 mm	2x4.2 mm	70 °C	Black/red	100 m
190845	50	6	2x0.75 mm ²	24/0.195 mm	2.5x5 mm	70 °C	Black/red	100 m
191087	50	6	2x0.75 mm ²	24/0.195 mm	2.9x5.5 mm	70 °C	Transparent	100 m
191086	50	16	2x1.5 mm ²	30/0.250 mm	3x6 mm	70 °C	Black/red	100 m
191093	50	20	2x2.5 mm ²	50/0.250 mm	3.6x7.4 mm	70 °C	Black/red	100 m

MULTI CORE SILICONE

2X0.75 MM²

HC-CARGO	Voltage	Amp	No./core	Conductor dim.	OD	Temp. area	Insulator	Colour	Min supply
191927	500	6	2x0.75 mm ²	24/0.195 mm	6.4 mm	-60 - +180 °C	Silicone	Blue/brown	100 m

2X1.5 MM²

HC-CARGO	Voltage	Amp	No./core	Conductor dim.	OD	Temp. area	Insulator	Colour	Min supply
191928	500	16	2x1.5 mm ²	30/0.250 mm	7.6 mm	-60 - +180 °C	Silicone	Blue/brown	100 m

MULTI CORE

WHITE COVER

HC-CARGO	Voltage	Amp	No./core	Conductor dim.	OD	Temp. area	Insulator	Colour	Min supply
190675	450/750	6	2x0.75 mm ²	24/0.195 mm	5.4 mm	60 °C	Unleaded PVC	Blue/brown	100 m
190685	300/300	6	2x0.75 mm ²	24/0.195 mm	6.4 mm	70 °C	Unleaded PVC	Blue/brown	100 m
192820	300/500	16	3gx1.5 mm ²	25/0.260 mm	9.4 mm	70 °C	Unleaded PVC	Blue/brown/ yellow-green	50 m

GREY COVER

HC-CARGO	Voltage	Amp	No./core	Conductor dim.	OD	Temp. area	Insulator	Colour	Min supply
191620	50	9	2x0.75 mm ²	24/0.200 mm	8.7 mm	-5 - +50 °C	Unleaded PVC	White/brown	100 m
191621	50	9	4x0.75 mm ²	24/0.200 mm	10.4 mm	-5 - +50 °C	Unleaded PVC	White/brown/ green/yellow	100 m
191623	50	12	12x1 mm ²	32/0.210 mm	12 mm	-5 - +70 °C	Unleaded PVC		100 m

BLACK COVER								
HC-CARGO	Voltage	Amp	No./core	Conductor dim.	OD	Insulator	Colour	Min supply
190676	50	6	2×0.75 mm ²	24/0.195 mm	4.4x6.8 mm	Unleaded PVC	Blue/brown	50 m
190686	50	6	2×0.75 mm ²	24/0.195 mm	6 mm	Unleaded PVC	Blue/brown	50 m
190690	300/500	6	2×0.75 mm ²	20/0.210 mm	6 mm	IEC 60332-1	Blue/brown	100 m
191617	300/500	10	2×1 mm ²	26/0.210 mm	7.2 mm	Unleaded PVC	Blue/brown	100 m
190691	450/750	12	2×1 mm ²	26/0.210 mm	9 mm	IEC 60332-1	Blue/brown	100 m
192789	50	10	2×1 mm ²	32/0.195 mm	4x6.4 mm	Unleaded PVC	White/black	50 m
191817	50	10	2×1 mm ²	32/0.195 mm	6.4 mm	Unleaded PVC	Blue/brown	50 m
191618	300/500	16	2×1.5 mm ²	25/0.260 mm	7 mm	Unleaded PVC	Blue/brown	100 m
190693	450/750	16	2×1.5 mm ²	25/0.260 mm	10 mm	IEC 60332-1	Blue/brown	100 m
190709	50	16	2×1.5 mm ²	30/0.250 mm	4.6x7.6 mm	Unleaded PVC	Blue/brown	50 m
190688	50	16	2×1.5 mm ²	30/0.250 mm	6.7 mm	Unleaded PVC	Blue/brown	50 m
191160	50	20	2×2.5 mm ²	50/0.250 mm	5.3x8.8 mm	Unleaded PVC	Blue/brown	50 m
192951	50	20	2×2.5 mm ²	50/0.250 mm	8.6 mm	Unleaded PVC	Blue/brown	50 m
190687	50	6	3×0.75 mm ²	24/0.195 mm	6.7 mm	Unleaded PVC	Blue/brown/black	50 m
190689	50	10	3×1 mm ²	32/0.195 mm	6.8 mm	Unleaded PVC	Blue/brown/black	50 m
191131	450/750	16	3×1.5 mm ²	25/0.260 mm	10 mm	IEC 60332-1	Blue/brown/yellow-green	100 m
191130	50	16	3×1.5 mm ²	30/0.250 mm	7.6 mm	Unleaded PVC	Blue/brown/black	50 m
192555	300/500	16	3×1.5 mm ²	25/0.260 mm	8.9 mm	Unleaded PVC	Blue/brown/yellow-green	50 m
191135	50	6	4×0.75 mm ²	24/0.195 mm	7.4 mm	Unleaded PVC	Blue/brown/black/yellow	50 m
190950	50	10	4×1 mm ²	32/0.195 mm	7.6 mm	Unleaded PVC	Blue/brown/black/yellow	50 m
191062	450/750	16	4×1.5 mm ²	25/0.260 mm	11 mm	IEC 60332-1	Blue/brown/black/yellow-green	100 m
191136	50	16	4×1.5 mm ²	30/0.250 mm	8.6 mm	Unleaded PVC	Blue/brown/black/yellow	50 m
191619	300/500	16	4×1.5 mm ²	25/0.260 mm	9.1-10.5 mm	Unleaded PVC	Blue/brown/black/yellow-green	50 m
191419	50	4.5	5×0.75 mm ²	24/0.195 mm	8.1 mm	Unleaded PVC	Blue/brown/black/yellow/green	50 m
190981	50	7.5	5×1 mm ²	32/0.195 mm	8.6 mm	Unleaded PVC	Blue/brown/black/yellow/green	50 m
190666	50	12	5×1.5 mm ²	30/0.250 mm	9.3 mm	Unleaded PVC	Blue/brown/black/yellow/green	50 m
192103	450/750	20	5×2.5 mm ²	25/0.260 mm	13.7 mm	IEC 60332-1	Blue/brown/black/black/yellow-green	50 m
191418	50	4.5	6×0.75 mm ²	24/0.195 mm	7.5 mm	Unleaded PVC	Blue/brown/black/yellow/white/red	50 m
190979	50	3.9	7×0.75 mm ²	24/0.195 mm	9.2 mm	Unleaded PVC	Blue/brown/black/yellow/green	50 m
190993	50	6.5	7×1 mm ²	32/0.195 mm	9.3 mm	Unleaded PVC	Blue/brown/black/yellow/green	50 m
190667	50	16	7×1.5 mm ²	30/0.250 mm	10.5 mm	Unleaded PVC	Blue/brown/black/yellow/green	50 m
190711	50	7.5/18.7	7×6x1+1x2.5 mm ²	32/0.195+50/0.250 mm	10.5 mm	Unleaded PVC	Blue/brown/black/yellow/green	50 m
191043	50	10/16	7×6x1.5+1x2.5 mm ²	30/0.250+50/0.250 mm	11.1 mm	Unleaded PVC	Blue/brown/black/yellow/green	50 m
191058	50	8.8	12×1.5 mm ²	30/0.250 mm	16.4 mm	Unleaded PVC	Blue/brown/black/yellow/green/red/white/grey/violet/pink/orange/turquoise	50 m
192104	50	8/12.5	13×9x1.5+4x2.5 mm ²	30/0.250+50/0.250 mm	16.6 mm	Unleaded PVC	Blue/brown/black/yellow/green/red/white/grey/purple/pink/orange/turquoise	50 m
191095	50	8/12.5/7	13×10x1.5+3x2.5 mm ²	30/0.250+50/0.250 mm	16 mm	Unleaded PVC	Blue/brown/black/yellow/green/red/white/grey/violet/pink/orange/turquoise/transparent	50 m

WELDING

RED PVC COVER

HC-CARGO	Min supply	HC-CARGO	Min supply	Voltage	Amp	No./core	Conductor dim.	OD	Temp. area
191535	25 m	B191574	100 m	200	106	1×10 mm ²	304/0.2 mm	7.3 mm	-5 - +85 °C
191574	25 m			200	135	1×16 mm ²	462/0.2 mm	8.7 mm	-5 - +85 °C
191451	25 m			200	170	1×25 mm ²	742/0.2 mm	10.5 mm	-5 - +85 °C
191452	25 m			200	217	1×35 mm ²	1008/0.2 mm	12 mm	-5 - +85 °C
191453	25 m			50 m	280	1×50 mm ²	1482/0.2 mm	13.8 mm	-5 - +85 °C
192446	10 m			50 m	350	1×70 mm ²	2090/0.2 mm	15.9 mm	-5 - +85 °C
193384	10 m			200	387	1×95 mm ²	2812/0.2 mm	18.2 mm	-5 - +85 °C

ORANGE PVC/NBR COVER

HC-CARGO	Min supply	HC-CARGO	Min supply	Voltage	Amp	No./core	Conductor dim.	OD	Temp. area	Insulator
191522	25 m	B191523	100 m	450/750	195	1×25 mm ²	742/0.2 mm	10.8 mm	-5 - +90 °C	Dual
191523	25 m			450/750	245	1×35 mm ²	1050/0.2 mm	12 mm	-5 - +90 °C	Dual
191524	25 m			450/750	310	1×50 mm ²	1482/0.2 mm	14.2 mm	-5 - +90 °C	Dual
192445	10 m			450/750	385	1×70 mm ²	2090/0.2 mm	16.7 mm	-5 - +90 °C	Dual

BLACK PVC COVER

HC-CARGO	Min supply	HC-CARGO	Min supply	Voltage	Amp	No./core	Conductor dim.	OD	Temp. area
191445	25 m	B191446	100 m	200	106	1×10 mm ²	312/0.2 mm	7.3 mm	-5 - +85 °C
191446	25 m			200	124	1×16 mm ²	462/0.2 mm	8.7 mm	-5 - +85 °C
191447	25 m			200	170	1×25 mm ²	742/0.2 mm	10.5 mm	-5 - +85 °C
191448	25 m			200	217	1×35 mm ²	1008/0.2 mm	10.5 mm	-5 - +85 °C
191449	25 m			50 m	280	1×50 mm ²	1482/0.2 mm	13.8 mm	-5 - +85 °C
191450	10 m			50 m	346	1×70 mm ²	2090/0.2 mm	15.9 mm	-5 - +85 °C
192881	10 m			50 m	387	1×95 mm ²	2812/0.20 mm	18.2 mm	-5 - +85 °C

BLACK PVC/NBR COVER

HC-CARGO	Voltage	Amp	No./core	Conductor dim.	OD	Temp. area	Insulator	Min supply
191516	450/750	115	1×10 mm ²	304/0.2 mm	7.4 mm	-5 - +90 °C	Dual	25 m
191517	450/750	145	1×16 mm ²	490/0.2 mm	8.6 mm	-5 - +90 °C	Dual	25 m
191518	450/750	195	1×25 mm ²	742/0.2 mm	10.8 mm	-5 - +90 °C	Dual	25 m
191519	450/750	245	1×35 mm ²	1050/0.2 mm	12 mm	-5 - +90 °C	Dual	25 m
191520	450/750	310	1×50 mm ²	1482/0.2 mm	14.2 mm	-5 - +90 °C	Dual	25 m
191521	450/750	385	1×70 mm ²	2090/0.2 mm	16.7 mm	-5 - +90 °C	Dual	10 m
192882	450/750	430	1×95 mm ²	2812/0.20 mm	18.8 mm	-5 - +90 °C	Dual	10 m

STARTER

RED PVC COVER

HC-CARGO	Min supply	HC-CARGO	Min supply	Voltage	Amp	No./core	Conductor dim.	OD	Temp. area
192291	25 m	B192291	100 m	450/750	135	1×35 mm ²	420/0.32 mm	10 mm	-25 - +70 °C
192292	25 m	B192292	50 m	450/750	160	1×50 mm ²	588/0.32 mm	12 mm	-25 - +70 °C

BLACK PVC COVER

HC-CARGO	Min supply	HC-CARGO	Min supply	Voltage	Amp	No./core	Conductor dim.	OD	Temp. area
191132	25 m	B191132	100 m	450/750	63	1×10 mm ²	120/0.32 mm	6.5 mm	-25 - +70 °C
190680	25 m	B190680	100 m	450/750	82	1×16 mm ²	196/0.32 mm	7.5 mm	-25 - +70 °C
190681	25 m	B190681	100 m	200	110	1×25 mm ²	294/0.31 mm	10.5 mm	70 °C
190682	25 m	B190682	100 m	450/750	135	1×35 mm ²	420/0.32 mm	10 mm	-25 - +70 °C
190683	25 m	B190683	50 m	450/750	160	1×50 mm ²	588/0.32 mm	12 mm	-25 - +70 °C
190684	10 m	B190684	50 m	450/750	205	1×70 mm ²	840/0.32 mm	14.5 mm	-25 - +70 °C

PARALLEL TWIN BATTERY

HC-CARGO	Min supply	HC-CARGO	Min supply	Voltage	Amp	No./core	Conductor dim.	OD	Temp. area		
191793	25 m	B191525	100 m	500	28	2×4 mm ²	114/0.2 mm	6x13 mm	-5 - +70 °C		
191794	25 m			500	36	2×6 mm ²	172/0.2 mm	6.5x14 mm	-5 - +70 °C		
191795	25 m			500	63	2×10 mm ²	296/0.2 mm	8x17 mm	-5 - +70 °C		
191796	25 m			500	135	2×16 mm ²	462/0.2 mm	9x19 mm	-5 - +70 °C		
191525	10 m			500	230	2×25 mm ²	722/0.21 mm	11x23 mm	-5 - +70 °C		
191526	10 m			B191526	50 m	500	290	2×35 mm ²	1026/0.2 mm	12.5x26 mm	-5 - +70 °C
191527	10 m			500	370	2×50 mm ²	1482/0.2 mm	14.5x30 mm	-5 - +70 °C		

DISPLAY
06219 Cable/Shrink Pipe Display Std pkg 1

Contains maks. 8 boxes. Can be placed on the counter or mounted on wall.

BOOSTER
STEEL CLIPS
192206 Booster cable set 10 mm² Std pkg 1

Amp: 80

 Conductor dim.:
79/0.4 mm
Conductor dim. 1:
10 mm²
Length: 2.5 m

 Colour: Red/black
Material: Galvanized steel
No./wires: 2

192207 Booster cable set 16 mm² Std pkg 1

Amp: 100

 Conductor dim.:
126/0.4 mm
Conductor dim. 1:
16 mm²
Length: 2.5 m

 Colour: Red/black
Material: Galvanized steel
No./wires: 2

192208 Booster cable set 25 mm² Std pkg 1

Amp: 120

 Conductor dim.:
188/0.4 mm
Conductor dim. 1:
25 mm²
Length: 2.5 m

 Colour: Red/black
Material: Galvanized steel
No./wires: 2

BRASS CHARGING CLIPS
192209 Booster cable set Std pkg 1

Amp: 230

 Conductor dim.:
770/0.2 mm
Conductor dim. 1:
25 mm²
Length: 3.5 m





 Colour: Red/black
Material: Moulded brass
No./wires: 2
BS-approved: BS638

192210 Booster cable set Std pkg 1

Amp: 290

 Conductor dim.:
1083/0.2 mm
Conductor dim. 1:
35 mm²
Length: 3.5 m

 Colour: Red/black
Material: Moulded brass
No./wires: 2
BS-approved: BS638

		EL. SPECIFICATIONS	DIMENSIONS	ADDITIONAL SPECIFICATIONS	
192211	Booster cable set Std pkg 1		Amp: 370	Conductor dim.: 1558/0.2 mm Conductor dim. 1: 50 mm ² Length: 3.5 m	Colour: Red/black Material: Moulded brass No./wires: 2 BS-approved: BS638
192212	Booster cable set Std pkg 1		Amp: 370	Conductor dim.: 1558/0.2 mm Conductor dim. 1: 50 mm ² Length: 5 m	Colour: Red/black Material: Moulded brass No./wires: 2 BS-approved: BS638
192295	Booster cable set Std pkg 1		Amp: 135	Conductor dim.: 265/0.41 mm Conductor dim. 1: 35 mm ² Length: 3.5 m	Colour: Red/black Material: Moulded brass No./wires: 2
192296	Booster cable set Std pkg 1		Amp: 160	Conductor dim.: 378/0.41 mm Conductor dim. 1: 50 mm ² Length: 5 m	Colour: Red/black Material: Moulded brass No./wires: 2
192844	Booster cable set Std pkg 1		Amp: 290	Conductor dim.: 1008/0.2 mm Conductor dim. 1: 35 mm ² Length: 5 m	Colour: Red/black Material: Moulded brass No./wires: 2 BS-approved: BS638
FULLY INSULATED CLIPS					
192213	Booster cable set Std pkg 1		Amp: 290	Conductor dim.: 1083/0.2 mm Conductor dim. 1: 35 mm ² Length: 3.5 m	Colour: Red/black No./wires: 2 Insulator: Yes Braided link: w/ BS-approved: BS638 Alternativ no.: 192384
192214	Booster cable set Std pkg 1		Amp: 370	Conductor dim.: 1558/0.2 mm Conductor dim. 1: 50 mm ² Length: 3.5 m	Colour: Red/black Material: Compressed steel No./wires: 2 Insulator: Yes Braided link: w/ BS-approved: BS638

		EL. SPECIFICATIONS	DIMENSIONS	ADDITIONAL SPECIFICATIONS
192215	Booster cable set Std pkg 1	Amp: 370	Conductor dim.: 1558/0.2 mm Conductor dim. 1: 50 mm ² Length: 5 m	Colour: Red/black Material: Compressed steel No./wires: 2 Insulator: Yes Braided link: w/ BS-approved: BS638 Alternativ no.: 192385
				
192384	Booster cable set Std pkg 1	Amp: 290	Conductor dim.: 1083/0.2 mm Conductor dim. 1: 35 mm ² Length: 3.5 m	Colour: Red/black Material: Copper/Brass No./wires: 2 Insulator: Yes Braided link: w/ DIN norm: 72553 Alternativ no.: 192213
				
192385	Booster cable set Std pkg 1	Amp: 370	Conductor dim.: 1558/0.2 mm Conductor dim. 1: 50 mm ² Length: 5 m	Colour: Red/black Material: Copper/Brass No./wires: 2 Insulator: Yes Braided link: w/ DIN norm: 72553 Alternativ no.: 192215
				
CHARGING CLIPS				
192196	Charging Clips Std pkg 1	Amp: 275	Cable dim.: 16 mm ²	Colour: Red Material: Moulded brass
				
192197	Charging Clips Std pkg 1	Amp: 275	Cable dim.: 16 mm ²	Colour: Black Material: Moulded brass
				
192293	Charging Clips Std pkg 1 Lenght: 210 mm.	Amp: 420	Cable dim.: 35-50 mm ²	Colour: Red Material: PP/PVC
				
192294	Charging Clips Std pkg 1 Lenght: 210 mm.	Amp: 420	Cable dim.: 35-50 mm ²	Colour: Black Material: PP/PVC
				

		EL. SPECIFICATIONS	DIMENSIONS	ADDITIONAL SPECIFICATIONS
192386	Charging Clips	Std pkg 1		
	Amp: 275	Cable dim.: 16 mm ²	Colour: Red Material: Moulded brass	
192387	Charging Clips	Std pkg 1		
	Amp: 275	Cable dim.: 16 mm ²	Colour: Black Material: Moulded brass	
192388	Charging Clips	Std pkg 1		
	Amp: 320	Cable dim.: 25 mm ²	Colour: Red Material: Moulded brass	
192389	Charging Clips	Std pkg 1		
	Amp: 320	Cable dim.: 25 mm ²	Colour: Black Material: Moulded brass	
192390	Charging Clips	Std pkg 1		
	Amp: 420	Cable dim.: 50 mm ²	Colour: Red Material: Moulded brass	
192391	Charging Clips	Std pkg 1		
	Amp: 420	Cable dim.: 50 mm ²	Colour: Black Material: Moulded brass	
192903	Charging clips, red	Std pkg 1		
	Amp: 1200	Cable dim.: 25-50 mm ²	Colour: Red Material: Brass	

		EL. SPECIFICATIONS	DIMENSIONS	ADDITIONAL SPECIFICATIONS
192904 Charging clips, Black Std pkg 1		Amp: 1200	Cable dim.: 25-50 mm ²	Colour: Black Material: Brass
FULLY INSULATED				
192204 Charging clips 600A,red Std pkg 1		Amp: 600	Cable dim.: 25-50 mm ²	Colour: Red Material: Compressed steel Fully insulated: Yes Braided link: w/ Alternativ no.: 192398
192205 Charging clips 600A, BL Std pkg 1		Amp: 600	Cable dim.: 25-50 mm ²	Colour: Black Material: Compressed steel Fully insulated: Yes Braided link: w/ Alternativ no.: 192399
192398 Charging Clips Std pkg 1		Amp: 600	Cable dim.: 50 mm ²	Colour: Red Material: Copper/Brass Fully insulated: Yes Braided link: w/ Alternativ no.: 192204
192399 Charging Clips Std pkg 1		Amp: 600	Cable dim.: 50 mm ²	Colour: Black Material: Copper/Brass Fully insulated: Yes Braided link: w/ Alternativ no.: 192205
192559 Charging Clips 500 A Std pkg 1		Amp: 500	Cable dim.: 25-50 mm ²	Colour: Red Material: Moulded brass Fully insulated: Yes
192560 Charging Clips 500 A Std pkg 1		Amp: 500	Cable dim.: 25-50 mm ²	Colour: Black Material: Moulded brass Fully insulated: Yes

ALLIGATOR & UNIVERSAL CLIPS
ALLIGATOR

192190 Alligator Clip Std pkg 25



Amp: 5

 Jaw opening: 11 mm
Length: 50 mm

192191 Alligator Clip Std pkg 10



Amp: 40

 Jaw opening: 14 mm
Length: 75 mm

 Type: Positive
Colour: Red

192192 Alligator Clip Std pkg 10



Amp: 40

 Jaw opening: 14 mm
Length: 75 mm

 Type: Negative
Colour: Black

192659 Alligator Clip Std pkg 1



Amp: 10

 Jaw opening: 11 mm
Length: 80 mm

 Type: Positive
Colour: Red

192660 Alligator Clip Std pkg 1



Amp: 10

 Jaw opening: 11 mm
Length: 80 mm

 Type: Negative
Colour: Black

UNIVERSAL





192700 Universal Clips Std pkg 5



Amp: 25

 Jaw opening: 19 mm
Length: 70 mm

 Type: Positive
Alternativ no.: 193239

		EL. SPECIFICATIONS	DIMENSIONS	ADDITIONAL SPECIFICATIONS
192701	Universal Clips	Std pkg 5		
		Amp: 25	Jaw opening: 19 mm Length: 70 mm	Type: Negative Alternativ no.: 193240
192702	Universal Clips	Std pkg 5		
		Amp: 50	Jaw opening: 25 mm Length: 100 mm	Type: Positive
192703	Universal Clips	Std pkg 5		
		Amp: 50	Jaw opening: 25 mm Length: 100 mm	Type: Negative
193239	Universal Clips	Std pkg 1		
		Amp: 25	Jaw opening: 12 mm Length: 75 mm	Type: Positive Alternativ no.: 192700
193240	Universal Clips	Std pkg 1		
		Amp: 25	Jaw opening: 12 mm Length: 75 mm	Type: Negative Alternativ no.: 192701

CABLE COILS

BATTERY

	HC-CARGO	Std pkg	Lead dim.	Windings	Material	Colour	OD	Working length
	191201	Pkg. 1	25 mm ²	35	Polyurethan	Black	13.5 mm	3.5 m
	192724	Pkg. 1	35 mm ²	35	Polyurethan	Red	13.5 mm	3.5 m
	192723	Pkg. 1	35 mm ²	35	Polyurethan	Black	13.5 mm	3.5 m
	191238	Pkg. 1	25 mm ²	35	Polyurethan	Red	13.5 mm	3.5 m
	192722	Pkg. 1	2x35 mm ²	35	Polyurethan	Red/black	13.5 mm	3.5 m

ELECTRICAL

	HC-CARGO	Std pkg	Lead dim.	Windings	Material	DIN Norm	ISO Norm	Plugtype	Working-length
	191179	Pkg. 1	2x4/3x1.5 mm ²	48	Polyurethan	74001	4141	5-core	4 m
	192582	Pkg. 1	4x0.75 mm ²	68	Polyurethan	72575		4-core	5.5 m
	192583	Pkg. 1	5x0.75 mm ²	68	Polyurethan		7638	5-core	5.5 m
	191013	Pkg. 1	6x1+1x2 mm ²	20	Nylon	72551	4141	7-core	3.5 m
	191088	Pkg. 1	6x1+1x2 mm ²	42	Polyurethan		4141	7-core	3.5 m
	191495	Pkg. 1	6x1+1x2 mm ²	63	Polyurethan			7-core	5 m
	191195	Pkg. 1	12x1.5+3x2.5 mm ²	34	Polyurethan		12098	15-core	3.5 m

IGNITION

150401 Protection Cap Std pkg 10

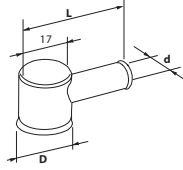
For spark plug cap. Angled.

 Cable dia.: 7.5 mm
 Cable dia. 2: 15 mm²
 Length: 41 mm

 Colour: Black
 Material: PVC

190695 Ignition Cable Std pkg 50

 Conductor dim.:
 19/0.3 mm
 Conductor dim.:
 1.5 mm²
 OD: 7 mm
 Roll size: 50 m

 Cable type: Ignition cable
 Cap colour: Black
 Cap material: PVC

CABLE EYELETS

191805 Cable Eyelet Std pkg 100

 OD: 7.2 mm
 Height: 3.6 mm

Material: Brass

192658 Cable Eyelet Std pkg 100

 OD: 8 mm
 Height: 3.6 mm

Material: Brass

HOSES

WOVEN

	HC-CARGO	Std pkg	ID	Length	Box dim.	Pressure	
	191499	Pkg. 20	3.2 mm	20 m	28.5x29.5x11.5 cm	5 bar	<i>Also for unleaded petrol.</i>
	190994	Pkg. 20	3.5 mm	20 m	28.5x29.5x11.5 cm	5 bar	<i>Also for unleaded petrol.</i>
	191014	Pkg. 20	4.5 mm	20 m	28.5x29.5x11.5 cm	5 bar	<i>Also for unleaded petrol.</i>
	190995	Pkg. 20	5 mm	20 m	28.5x29.5x11.5 cm	5 bar	<i>Also for unleaded petrol.</i>
	190996	Pkg. 20	6 mm	20 m	28.5x29.5x11.5 cm	5 bar	<i>Also for unleaded petrol.</i>
	190997	Pkg. 20	7.5 mm	20 m	28.5x29.5x11.5 cm	5 bar	<i>Also for unleaded petrol.</i>
	191015	Pkg. 20	9 mm	20 m	28.5x29.5x11.5 cm	5 bar	<i>Also for unleaded petrol.</i>
192361	Pkg. 10	11 mm	10 m	28.5x29.5x11.5 cm	5 bar	<i>Also for unleaded petrol.</i>	

NON-WOVEN

	HC-CARGO	Std pkg	ID	OD	Box dim.	Pressure	DIN Norm	
	191182	Pkg. 20	3.5 mm	9.5 mm	28.5x29.5x11.5 cm	10 bar	73379	<i>Also for unleaded petrol.</i>
	190998	Pkg. 20	5 mm	11 mm	28.5x29.5x11.5 cm	10 bar	73379	<i>Also for unleaded petrol.</i>
	191063	Pkg. 20	5.5 mm	11.5 mm	28.5x29.5x11.5 cm	10 bar	73379	<i>Also for unleaded petrol.</i>
	190999	Pkg. 20	6 mm	12 mm	28.5x29.5x11.5 cm	10 bar	73379	<i>Also for unleaded petrol.</i>
	191000	Pkg. 20	7.5 mm	13.5 mm	28.5x29.5x11.5 cm	10 bar	73379	<i>Also for unleaded petrol.</i>
	190984	Pkg. 20	9.5 mm	15.5 mm	28.5x29.5x11.5 cm	10 bar	73379	<i>Also for unleaded petrol.</i>

PLASTIC

	HC-CARGO	Std pkg	ID	OD	Length	Pressure	Temp.	Hose type
	190093	Pkg. 50	3 mm	4.5 mm	10 m		-15 - +60 °C	Washer
	190094	Pkg. 50	4 mm	5.5 mm	50 m		-15 - +60 °C	Washer
	190095	Pkg. 50	5 mm	7.3 mm	50 m		-15 - +60 °C	Washer
	190096	Pkg. 50	6 mm	9.8 mm	50 m		-15 - +60 °C	Washer
	090170	Pkg. 10	6 mm	10 mm	10 m	2.8-3.5 bar		Fuel
	190097	Pkg. 50	8 mm	11.6 mm	50 m		-15 - +60 °C	Washer
	090171	Pkg. 10	8 mm	12 mm	10 m	2.8-3.5 bar		Fuel

ARMoured PLASTIC

190100 Armoured PA hose Std pkg 50

Petrol and fuel resistant.

 ID: 6 mm
 Length: 50 m
 Temp.: -5 - +60 °C
 Working pressure at
 °C: 25 kg./cm²

 Hose type: Armoured
 Colour: Transparent
 Material: PVC

190101 Armoured hose Std pkg 50

Petrol and fuel resistant.

 ID: 8 mm
 Length: 50 m
 Temp.: -5 - +60 °C
 Working pressure at
 °C: 20 kg./cm²

 Hose type: Armoured
 Colour: Transparent
 Material: PVC

OVERFLOW

090293 Over flow hose high temperatur Std pkg 20 Servicing: Among others Mercedes - Visit our web catalogue for further information

Specially designed for Mercedes where the nozzle is stored in the valve cover. Tolerates higher temperatures.

 ID: 3 mm
 OD: 7 mm
 Length: 20 m
 Temp.: 110 °C
 Pressure: 10 bar
 Working pressure at
 °C: 5 kg./cm²

 Colour: Grey/red
 Woven: Yes

HEATER

192720 Heater Hose Std pkg 10

Black EPDM rubber. Temperature resistant between -25°C-+100°C.

 Box dim.:
 28.5x29.5x11.5 cm
 ID: 16 mm
 Length: 10 m
 Temp.: -25 - +100 °C
 Pressure: 10 bar

 Hose type: Water
 Colour: Black

SYNTHETIC RUBBER STEEL WIRE

	HC-CARGO	Std pkg	HC-CARGO	Std pkg	ID	OD	Length	Pressure	DIN Norm	Temp.
<i>Braiding of galvanized steel wire. Material: Rubber</i>										
	090078	Pkg. 10			4.5 mm	9.5 mm	10 m	20 bar	73379	-35 - +80 °C
	090079	Pkg. 10	B090079	Pkg. 50	5.5 mm	10.5 mm	10 m	20 bar	73379	-35 - +80 °C
	090080	Pkg. 10	B090080	Pkg. 50	7.5 mm	12.5 mm	10 m	20 bar	73379	-35 - +80 °C
	090081	Pkg. 10	B090081	Pkg. 50	9 mm	14 mm	10 m	20 bar	73379	-35 - +80 °C
	090082	Pkg. 10			11 mm	17.7 mm	10 m	20 bar	73379	-35 - +80 °C

POLYAMID

	HC-CARGO	Std pkg	ID	OD	Length	Pressure	DIN Norm	Temp.
<i>Hose type: Air pressure, Colour: Black</i>								
	B090148	Pkg. 25	4 mm	6 mm	25 m	27 bar	74324	-40 - +100 °C
	B090083	Pkg. 25	6 mm	8 mm	25 m	27 bar	74324	-40 - +100 °C
	B090084	Pkg. 25	8 mm	10 mm	25 m	27 bar	74324	-40 - +100 °C
	B090119	Pkg. 25	9 mm	12 mm	25 m	27 bar	74324	-40 - +100 °C

VACUUM

191192 Vacuum Hose

Std pkg 20



Box dim.: 28.5x29.5x11.5 cm
ID: 3 mm
Length: 20 m

Colour: Black

191193 Vacuum Hose

Std pkg 20



Box dim.: 28.5x29.5x11.5 cm
ID: 4 mm
Length: 20 m

Hose type: Armoured
Colour: Black

PIPES

	HC-CARGO	Std pkg	ID	Thread
	080829	Pkg. 1	6 mm	M10-1
	080830	Pkg. 1	6 mm	M12-1.5
	080287	Pkg. 1	6 mm	M12-1.5
	080931	Pkg. 5	8 mm	1/2"-20 UNF
	080930	Pkg. 5	8 mm	1/2"-20 UNF
	080831	Pkg. 1	8 mm	M14-1.5
	080288	Pkg. 1	8 mm	M14-1.5
	080268	Pkg. 5	8 mm	
	080289	Pkg. 1	10 mm	M16-1.5

HOSE SLEEVES

	HC-CARGO	Std pkg	ID	OD	Length
	080285	Pkg. 10	5 mm	6 mm	14.1 mm
	080260	Pkg. 10	11 mm	11.5 mm	17 mm
	080259	Pkg. 10	11 mm	13 mm	17 mm
	080261	Pkg. 10	12 mm	12.5 mm	20 mm
	080262	Pkg. 10	13.5 mm	13.5 mm	20 mm
	080263	Pkg. 10	14 mm	14.5 mm	20 mm
	080264	Pkg. 10	16 mm	16 mm	20 mm
	080265	Pkg. 10	17 mm	17.5 mm	21 mm

NUTS

080297 Pipe Nut 10 X 1,5 mm.

Std pkg 10



Thread: M10-1.5

080667 Pipe Nut

Std pkg 10



Thread: M10-1

080668 Pipe Nut

Std pkg 10



Thread: M 14-1.5

080669 Pipe Nut

Std pkg 10



Thread: M16-1.5

CLAMPS

HOSE

	HC-CARGO	Std pkg	ID min	ID max	Width	Ref. no.	Material
Spanner size: 7 mm, Coating: Electro galvanized, Alu/zinc, Lacquered							
	193027	Pkg. 50	8 mm	14 mm	10 mm	15	Carbon steel
	190157	Pkg. 50	8 mm	14 mm	9 mm	15	Steel
	190158	Pkg. 50	11 mm	17 mm	9 mm	17	Steel
	193028	Pkg. 50	11 mm	17 mm	10 mm	17	Carbon steel
	190159	Pkg. 50	13 mm	20 mm	9 mm	22	Steel
	193029	Pkg. 50	13 mm	20 mm	10 mm	22	Carbon steel
	190160	Pkg. 50	15 mm	24 mm	12 mm	25	Steel
	193030	Pkg. 50	15 mm	24 mm	12 mm	25	Carbon steel
	190161	Pkg. 50	19 mm	28 mm	12 mm	28	Steel
	193031	Pkg. 50	19 mm	28 mm	12 mm	28	Carbon steel
	190162	Pkg. 50	22 mm	32 mm	12 mm	32	Steel
	193032	Pkg. 50	22 mm	32 mm	12 mm	32	Carbon steel
	190163	Pkg. 50	26 mm	38 mm	12 mm	40	Steel
	193033	Pkg. 50	26 mm	38 mm	12 mm	40	Carbon steel
	190164	Pkg. 50	32 mm	44 mm	12 mm	45	Steel
	193034	Pkg. 50	32 mm	44 mm	12 mm	45	Carbon steel
	190165	Pkg. 50	38 mm	50 mm	12 mm	51	Steel
	193035	Pkg. 50	38 mm	50 mm	12 mm	51	Carbon steel
	190166	Pkg. 50	44 mm	56 mm	12 mm	56	Steel
	193036	Pkg. 50	44 mm	56 mm	12 mm	56	Carbon steel
190167	Pkg. 10	50 mm	65 mm	12 mm	65	Steel	
193037	Pkg. 10	50 mm	65 mm	12 mm	65	Carbon steel	
190168	Pkg. 10	58 mm	75 mm	12 mm	75	Steel	
193038	Pkg. 10	58 mm	75 mm	12 mm	75	Carbon steel	
190169	Pkg. 10	68 mm	85 mm	12 mm	85	Steel	
193039	Pkg. 10	68 mm	85 mm	12 mm	85	Carbon steel	
190170	Pkg. 10	77 mm	95 mm	12 mm	96	Steel	
193040	Pkg. 10	77 mm	95 mm	12 mm	96	Carbon steel	
190171	Pkg. 10	87 mm	112 mm	12 mm	113	Steel	
193041	Pkg. 10	87 mm	112 mm	12 mm	113	Carbon steel	
190172	Pkg. 10	104 mm	138 mm	12 mm	139	Steel	
191239	Pkg. 10	130 mm	165 mm	12 mm	166	Steel	

MINI

	HC-CARGO	Std pkg	ID min	ID max	Width	Ref. no.	Material
Spanner size: 7 mm, Coating: Electro galvanized, Alu/zinc, Lacquered							
	190005	Pkg. 50	6 mm	8.3 mm	9 mm	8	Steel
	190006	Pkg. 50	7 mm	9.3 mm	9 mm	9	Steel
	190007	Pkg. 50	8 mm	10.3 mm	9 mm	10	Steel
	190008	Pkg. 50	9 mm	11.3 mm	9 mm	10	Steel
	190009	Pkg. 50	9 mm	12.3 mm	9 mm	12	Steel
	190010	Pkg. 50	10 mm	13.3 mm	9 mm	13	Steel
	190937	Pkg. 50	11 mm	14.3 mm	9 mm	14	Steel
	190938	Pkg. 50	12 mm	15.3 mm	9 mm	15	Steel
	191056	Pkg. 50	13 mm	16.3 mm	9 mm	16	Steel
	192054	Pkg. 50	14 mm	17.3 mm	9 mm	17	Steel

TOOLS

HOSE CLAMP SCREWDRIVERS

210249 Hose Clamp Screwdriver Pkg. 1

Flexible.



PIPE

	HC-CARGO	Std pkg	ID	Thickness	Material	
	191592	Pkg. 10	42 mm	1 5/8"	8 mm	Galvanized steel
	191593	Pkg. 10	45 mm	1 3/4"	8 mm	Galvanized steel
	191594	Pkg. 10	48 mm	1 7/8"	8 mm	Galvanized steel
	191595	Pkg. 10	51 mm	2"	8 mm	Galvanized steel
	191596	Pkg. 10	54 mm	2 1/8"	8 mm	Galvanized steel
	191597	Pkg. 10	57 mm	2 1/4"	8 mm	Galvanized steel

EAR CLIPS

192817 Ear Clip Pkg. 100

w/ inserts. Min. 8.5 mm. Max 10.5 mm.



192818 Ear Clip Pkg. 100

w/ inserts. Min. 9.5 mm. Max 11.5 mm.



TAPES

INSULATION TAPE





	HC-CARGO	Std pkg	Width	Dim.	Colour	Material
	190180	Pkg. 20	15 mm	0.1 mm x 10 m	Black	PVC
	190181	Pkg. 20	15 mm	0.1 mm x 10 m	Red	PVC
	190182	Pkg. 20	15 mm	0.1 mm x 10 m	Blue	PVC
	190183	Pkg. 20	15 mm	0.1 mm x 10 m	Green	PVC
	190184	Pkg. 20	15 mm	0.1 mm x 10 m	Yellow	PVC
	190185	Pkg. 20	15 mm	0.1 mm x 10 m	Grey	PVC
	190186	Pkg. 20	15 mm	0.1 mm x 10 m	White	PVC
	190187	Pkg. 16	19 mm	0.1 mm x 10 m	Black	PVC
	193220	Pkg. 10	15 mm	0.1 mm x 10 m	Black	PVC
	193221	Pkg. 10	15 mm	0.1 mm x 10 m	Red	PVC
	193222	Pkg. 10	15 mm	0.1 mm x 10 m	Blue	PVC
	193223	Pkg. 10	15 mm	0.1 mm x 10 m	Green	PVC
	193224	Pkg. 10	15 mm	0.1 mm x 10 m	Yellow	PVC
	193225	Pkg. 10	15 mm	0.1 mm x 10 m	Grey	PVC
	193226	Pkg. 10	15 mm	0.1 mm x 10 m	White	PVC
	193227	Pkg. 10	19 mm	0.1 mm x 10 m	Black	PVC
	191065	Pkg. 6	50 mm	0.2 mm x 20 m	Black	PVC

TEXTILE TAPE

	HC-CARGO	Std pkg	Width	Length	Colour	Material
	193231	Pkg. 5	9 mm	25 m	Black	Textile
	192366	Pkg. 5	9 mm	25 m	Black	Textile
	191237	Pkg. 5	19 mm	25 m	Black	Textile
	192755	Pkg. 1	50 mm	50 m	Grey	
	193232	Pkg. 1	50 mm	50 m	Grey	

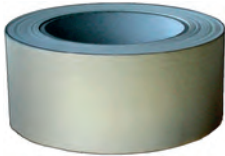
FIELD COIL TAPE

	HC-CARGO	Std pkg	Width	Length	Material
	193374	Pkg. 500	10 mm	500 m	Polyester
	193375	Pkg. 100	20 mm	100 m	Polyester

THREAD SEAL TAPE			
192379 Threaded Tape		Std pkg 10	
		Length: 12 m Thickness: 12 mm	Colour: White Material: PTFE
MASKING			
	HC-CARGO	Std pkg	Width
	200004	Pkg. 1	50 mm
	200005	Pkg. 1	25 mm
			Dim.
			50 m
			50 m
ADHESIVE			
SILICONE COMPOUND			
134686 Dielectric Gel		Std pkg 1	
<i>Prevents fusing of spark wires and corrosion. Odourless, non-volatile. Works in extreme temperatures. Resists moisture, air, acids and alkalines.</i>			
		Content: 142 g	Alternativ no.: 232776
200094 Silicone Compound		Std pkg 1	
<i>Used for motors, windshield and sunroof.</i>			
		Content: >85	
SURFACE CLEANING			
200300 Glass beads 300-400 micron		Std pkg 25	
<i>Used for sand blowing. Used for surface treatment eg. cleaning, fine trimming, deburring and tumbling.</i>			
		Length: 25 mm Grades: 300-400 Grades 2: 0.3-0.4	Material: Glass Alternativ no.: b200300
200400 Steel Shot		Std pkg 25	
<i>Used for sand blowing. Used for surface treatment eg. cleaning, fine trimming, deburring and tumbling.</i>			
		Length: 25 mm Grades: 300-500 Grades 2: 0.3-0.5	Material: Steel Approval: SAEJ444

200500 Steel Shot Std pkg 25

Used for sand blowing. Used for surface treatment eg. cleaning, fine trimming, deburring and tumbling.



Length: 20 mm
Grades: 212-600
Grades 2: 0.2-0.6

Material: Steel

ABRASIVE CLOTHS

	HC-CARGO	Std pkg	Grades	Width	Length	Type
A flexible resin bonded aluminium oxide cloth for general purpose work shop use.						
	200721	Pkg. 1	P40	40 mm	50 m	Rolls
	200722	Pkg. 1	P60	40 mm	50 m	Rolls
	200723	Pkg. 1	P80	40 mm	50 m	Rolls
	200734	Pkg. 1	P120	40 mm	50 m	Rolls
	200810	Pkg. 1	P180	40 mm	50 m	Rolls

OIL & GREASE

BEARING GREASE

200746 Molykote br2+ Bearing Grease Std pkg 1

Molykote BR 2 plus universal heavy duty grease provides:

- Reduction of wear
- Emergency lubrication
- Higher operational reliability
- Extended lubrication intervals even under high loads and difficult running conditions. Molykote BR 2 plus is suitable for a wide temperature range; it is resistant to oxidation and resist hot and cold water. It also has good corrosion-inhibiting properties.

Range of application

Molykote BR 2 plus can be used wherever grease lubrication is normally applied, e.g. for:

- All types of antifriction bearings
- Plain bearings and guides
- Joints and splined shafts
- Threaded spindles and small gear units at low speeds and all bearings subject to severe impact loads or exposed to extreme atmospheric conditions
- For chassis lubrication on motor vehicles.



Content: 100 g

200748 Molykote 33 Bearing Grease Std pkg 1

Molykote 33 is used to lubricate ball and sometimes roller bearings operating under light to moderate loads and at low to medium speeds. Typical applications include: Starter drives, freezer, car casters and cold room conveyor equipment. Maximum demand meters, power factor meters, watt-hour meters, windshield wiper motor gears.



Content: 100 g

200749 Molykote 33 Bearing Grease Std pkg 1

Molykote 33 is used to lubricate ball and sometimes roller bearings operating under light to moderate loads and at low to medium speeds. Typical applications include: Starter drives, freezer, car casters and cold room conveyor equipment. Maximum demand meters, power factor meters, watt-hour meters, windshield wiper motor gears.



Content: 1 kg

HEAT TRANSFER COMPOUND

200618 Heat Transfer Compound Std pkg 1

Heat transfer grease is a grease-like silicone material heavily filled with heat conductive metal oxides. This material maintains a positive heat sink seal that transfer from electrical and electronic devices to the heat sink or chassis. Used where heat dissipation is required.



Content: 142 g

MULTI PURPOSE GREASE

200745 Multi Purpose Grease Std pkg 1

Universal grease for general and industrial use. For small and mediumsized bearings, even under demanding conditions. Has water repellent properties and protects against corrosion. Used in: agricultural machinery, motor wheel bearings, small electric motors, conveyor systems etc.



Content: 200 g

200747 Multi Purpose Grease Std pkg 1

Molykote BR 2 plus universal heavy duty grease provides:

- Reduction of wear
- Emergency lubrication
- Higher operational reliability
- Extended lubrication intervals even under high loads and difficult running conditions. Molykote BR 2 plus is suitable for a wide temperature range; it is resistant to oxidation and resist hot and cold water. It also has good corrosion-inhibiting properties.

Range of application

Molykote BR 2 plus can be used wherever grease lubrication is normally applied, e.g. for:

- All types of antifriction bearings
- Plain bearings and guides
- Joints and splined shafts
- Threaded spindles and small gear units at low speeds and all bearings subject to severe impact loads or exposed to extreme atmospheric conditions
- For chassis lubrication on motor vehicles.



Content: 1 kg

DRY BATTERIES

CARBON-ZINC

200735 Battery Std pkg 4



Voltage: 1.5

Dim.: 13.9x50 mm

ASA type: AA
LEC type: R6
Battery type: Carbon-Zinc
Heavy duty: Yes
Mercury: w/o
Cadmium: w/o

200796 Battery Std pkg 1









Voltage: 6

Dim.: 66x66x111 mm

LEC type: 4R25
Battery type: Carbon-Zinc
Heavy duty: Yes

ALKALINE

200601 Battery		Std pkg 1	GP 23AE-C1 Ultra FRP 20/400.		
	Voltage: 12	Dim.: 10x28 mm	LEC type: GA23 Battery type: Ultra Alkaline		
200738 Battery		Std pkg 4	Servicing: HC-CARGO 171749, 171805, 172089, 172103, 172104		
	Voltage: 1.5	Dim.: 10.5x44.5 mm	ASA type: AAA LEC type: LR03 Battery type: Alkaline Mercury: w/o Cadmium: w/o		
200739 Battery		Std pkg 4	Servicing: HC-CARGO 171797		
	Voltage: 1.5	Dim.: 14.5x50.5 mm	ASA type: AA LEC type: LR6 Battery type: Alkaline Mercury: w/o Cadmium: w/o		
200740 Battery		Std pkg 2	Servicing: HC-CARGO 171787		
	Voltage: 1.5	Dim.: 25.4x49.5 mm	ASA type: C LEC type: LR14 Battery type: Alkaline Mercury: w/o Cadmium: w/o		
200741 Battery		Std pkg 2	Servicing: HC-CARGO 170353, 170683		
	Voltage: 1.5	Dim.: 33x60.3 mm	ASA type: D LEC type: LR20 Battery type: Alkaline Mercury: w/o Cadmium: w/o		
200742 Battery		Std pkg 1	Servicing: HC-CARGO 171464, 171466		
<i>Digital Multimeter: HC-CARGO 210977.</i>					
	Voltage: 9	Dim.: 25.5x16.5x47 mm	LEC type: 6LR61 Battery type: Alkaline		
200792 Battery		Std pkg 2			
	Voltage: 1.5	Dim.: 11.7x29.1 mm	ASA type: N LEC type: LR1 Battery type: Alkaline Mercury: w/o Cadmium: w/o		

		EL. SPECIFICATIONS	DIMENSIONS	ADDITIONAL SPECIFICATIONS
200808 Battery Std pkg 2				
		Voltage: 1.5	Dim.: 42.5x8.3 mm	ASA type: AAAA LEC type: LR61 Battery type: Alkaline Mercury: w/o Cadmium: w/o
HIGH VOLTAGE				
200776 Battery Std pkg 1				
<i>Major applications: Electronic instruments, photo and remote control. High voltage.</i>				
		Voltage: 6	Dim.: 10x16 mm	LEC type: 4LR23 Battery type: Alkaline
200777 Battery Std pkg 1				
<i>Major applications: Electronic instruments, photo and remote control. High voltage. 27 Amp.</i>				
		Voltage: 12	Dim.: 7.7x28 mm	Battery type: Alkaline
200791 Battery Std pkg 1				
<i>Major applications: Electronic instruments, photo and remote control. High voltage.</i>				
		Voltage: 6	Dim.: 13x25.2 mm	LEC type: 4LR44 Battery type: Alkaline
LITHIUM				
200828 Lithium Battery Std pkg 1				
<i>Major applications: Torch light and photo.</i>				
		Voltage: 3 Miliamp: 1400	Dim.: 16.8x34.5 mm	
200848 Lithium Battery Std pkg 1				
		Voltage: 3 Miliamp: 160	Dim.: 11.6x10 mm	Battery type: Lithium
BUTTON				
200772 Battery Std pkg 10				
<i>Major applications: computer memory backup, photo, remote control and watch.</i>				
		Voltage: 3 Miliamp: 90	Dim.: 20x1.6 mm	LEC type: CR2016 Battery type: Lithium

200773 Battery		Std pkg 10	
<i>Major applications: computer memory backup, photo, remote control and watch.</i>			
	Voltage: 3 Miliamp: 36	Dim.: 12.5x2 mm	LEC type: CR1220 Battery type: Lithium
200774 Battery		Std pkg 10	
<i>Major applications: computer memory backup, photo, remote control and watch.</i>			
	Voltage: 3 Miliamp: 160	Dim.: 20x2.5 mm	LEC type: CR2025 Battery type: Lithium
200775 Battery		Std pkg 10	
<i>Major applications: computer memory backup, photo, remote control, watch and digital sliding gauge.</i>			
	Voltage: 3 Miliamp: 220	Dim.: 20x3.2 mm	LEC type: CR2032 Battery type: Lithium
200778 Battery		Std pkg 10	
<i>Major applications: calculator, photo, remote control and watch.</i>			
	Voltage: 1.5 Miliamp: 190	Dim.: 15.6x5.95 mm	LEC type: LR9 Battery type: Alkaline
200779 Battery		Std pkg 10	
<i>Major applications: calculator, photo, watch and digital sliding gauge.</i>			
	Voltage: 1.55 Miliamp: 130	Dim.: 11.6x5.4 mm	LEC type: SR44 Battery type: Mercury
200802 Battery		Std pkg 5	
<i>Major applications: computer memory backup, photo, remote control, watch and digital sliding gauge.</i>			
	Voltage: 3 Miliamp: 7.8	Dim.: 16x2 mm	LEC type: CR1620 Battery type: Lithium
200813 Battery		Std pkg 10	
<i>Major applications: computer memory backup, photo, remote control and watch.</i>			
	Voltage: 3 Miliamp: 140	Dim.: 16x3.2 mm	LEC type: CR1632 Battery type: Lithium

EL. SPECIFICATIONS		DIMENSIONS	ADDITIONAL SPECIFICATIONS
200846 Battery Std pkg 10			
<i>Major application: Eberspächer heater.</i>			
	Voltage: 3 Miliamp: 300	Dim.: 24x3 mm	LEC type: CR2430 Battery type: Lithium
200854 Battery Std pkg 10			
<i>Major applications: computer memory backup, photo, remote control and watch.</i>			
	Voltage: 3 Miliamp: 55	Dim.: 16x1.6 mm	LEC type: CR1616 Battery type: Lithium
200858 Battery Std pkg 10 Servicing: HC-CARGO 253489			
<i>For calculator, photo, clock and IA.</i>			
	Voltage: 1.5 Miliamp: 160	Dim.: 7.9x3.48 mm	LEC type: LR41 Battery type: Alkaline
200898 Battery Std pkg 10			
<i>Major applications: computer memory backup, photo, remote control and watch.</i>			
	Voltage: 3 Miliamp: 610	Dim.: 24.5x5 mm	LEC type: CR2450 Battery type: Lithium
RECHARGEABLE			
200766 Battery Std pkg 4			
	Voltage: 1.2 Miliamp: 2600	Dim.: 14.5x50.5 mm	ASA type: AA LEC type: RC06 Battery type: NIMH
200768 Battery Std pkg 2 Servicing: HC-CARGO 170353, 170683			
	Voltage: 1.2 Miliamp: 2200	Dim.: 34.2x61.5 mm	ASA type: D LEC type: RC20 Battery type: NIMH
200769 Battery Std pkg 1 Servicing: HC-CARGO 171464, 171466			
	Voltage: 8.4 Miliamp: 200	Dim.: 15.7x26.5x48 mm	LEC type: 9 V Battery type: NIMH

200851 ReCyco Battery Std pkg 4

New generation of rechargeable batteries. Recyco batteries have a superior charge retention capability. Comes precharged and ready to use right out of the pack.



Voltage: 1.2
Miliamp: 800

Dim.: 10.5x44.5 mm

ASA type: AAA
LEC type: RC03
Battery type: NIMH

200852 ReCyco Battery Std pkg 4 Servicing: HC-CARGO 200853



Voltage: 1.2
Miliamp: 2000

Dim.: 14.5x50 mm

ASA type: AA
LEC type: RC06
Battery type: NIMH

BATTERY CHARGER

200771 Battery Charger Std pkg 1

For AA, AAA, C, D and 9 V NIMH batteries. 7 hours to full charge. w/ automatic timer cut-out on full charge.



Dim.: 178x97x57 mm

Auto stop: Yes

200853 ReCyco Battery Charger Std pkg 1

For AA and AAA NIMH batteries. Individual charging channels, damaged battery detection, car charging function, universal voltage for worldwide use. Can charge 1-4 AA batteries or AAA batteries. Supplied w/ 4 pcs AA batteries (HC-CARGO 200852).



Dim.: 116x72.5x32 mm

Auto stop: Yes

PROTECTING CAPS, TUBES & PLUGS

PROTECTING CAPS

	HC-CARGO	Std pkg	ID/cone	OD/cone	Height	Type no.	Colour	Material
	191364	Pkg. 100	3.2/4 mm	4.8/5.5 mm	5.7 mm	3	Red	Polyethylen
	191365	Pkg. 100	4.5/5.3 mm	6/6.7 mm	5.9 mm	5	Red	Polyethylen
	191366	Pkg. 100	5/5.6 mm	6.8/7.4 mm	6.8 mm	6	Red	Polyethylen
	191367	Pkg. 100	6/7.1 mm	7.6/8.5 mm	8 mm	8	Red	Polyethylen
	192131	Pkg. 100	6.2/7.6 mm	5/5.9 mm	9.5 mm	7	Red	Polyethylen
	191368	Pkg. 100	6.9/7.9 mm	8.3/9.4 mm	9 mm	10	Red	Polyethylen
	191369	Pkg. 100	8.2/9.5 mm	10.1/11 mm	9.9 mm	12	Red	Polyethylen
	191370	Pkg. 100	9/10.8 mm	10.8/12.5 mm	9.6 mm	15	Red	Polyethylen
	191371	Pkg. 100	10.1/11.3 mm	11.4/12.8 mm	9.8 mm	16	Red	Polyethylen
	191642	Pkg. 100	10.6/12.1 mm	12/13.8 mm	11.1 mm	17	Red	Polyethylen
	191372	Pkg. 100	11.5/13 mm	13.1/14.5 mm	11.1 mm	18	Red	Polyethylen
	191373	Pkg. 100	12.4/14 mm	13.9/15.4 mm	12 mm	20	Red	Polyethylen
	191374	Pkg. 100	13/14.7 mm	14.2/15.7 mm	12.8 mm	25	Red	Polyethylen
	191375	Pkg. 100	14/15.5 mm	14.9/16.8 mm	12.8 mm	27	Red	Polyethylen
	191480	Pkg. 100	15.8/17.6 mm	17.2/18.9 mm	14 mm	30	Red	Polyethylen
191376	Pkg. 100	16.4/18.8 mm	18.2/20.2 mm	13.9 mm	35	Red	Polyethylen	

THREADED PROTECTION CAP							
	HC-CARGO	Std pkg	Thread	Height	Colour	Material	
	191862	Pkg. 100	M8-1	10 mm	Red	Polyethylen	
	191863	Pkg. 100	M10-1	10 mm	Red	Polyethylen	
	191864	Pkg. 100	M12-1	12 mm	Red	Polyethylen	
	191865	Pkg. 100	M12-1.5	12 mm	Red	Polyethylen	
	191866	Pkg. 100	M14-1.5	11.9 mm	Yellow	Polyethylen	
THREADED PLUG							
	HC-CARGO	Std pkg	Thread	Colour	Material		
	191857	Pkg. 100	M8-1	Red	Polyethylen		
	191858	Pkg. 100	M10-1	Red	Polyethylen		
	191859	Pkg. 100	M12-1	Red	Polyethylen		
	191860	Pkg. 100	M12-1.5	Red	Polyethylen		
	191861	Pkg. 100	M14-1.5	Red	Polyethylen		
PROTECTING TUBES							
PLASTIC							
	HC-CARGO	Std pkg	ID	OD	Height	Colour	Material
	191392	Pkg. 100	10 mm	14 mm	10 mm	Transparent	Plastic
PAPER							
	HC-CARGO	Std pkg	ID	OD	Height	Material	
	191390	Pkg. 100	16.4 mm	18.4 mm	17 mm	Cardboard	
	191391	Pkg. 500	19.5 mm	22.4 mm	14 mm	Cardboard	
RUBBER BOOTS							
191616 Rubber Boot "denka lift"		Std pkg 150					
			ID: 25 mm ID/cone: 63 mm Length: 80 mm				
RUBBER CAPS							
192988 Rubber Cap		Std pkg 250					
			ID: 4.8 mm Length: 12.8 mm		Colour: Black Material: EPDM rubber		

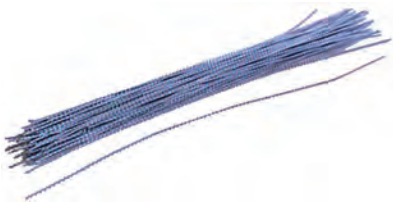
ASSEMBLY PARTS
SEALS & WIRE
080751 Seal Wire Std pkg 100

Length: 210 mm

081006 Seal Std pkg 100

OD: 9 mm

 Colour: Red
Material: Plastic

VALVES
080108 Overflow Valve Std pkg 1

 Thread: M14-1.5
Pressure: 0.5-1 bar

080109 Overflow Valve Std pkg 1

 Thread: M14-1.5
Pressure: 1.3-1.8 bar

080111 Overflow Valve Std pkg 1

Can be used w/ petrol & E85.

 Thread: M14-1.5
Pressure: 1.3-1.8 bar

080213 Overflow Valve Std pkg 1

Thread: M12x1.5

080250 Overflow Valve Std pkg 1

 Thread: M14-1.5
Pressure: 1.2-1.5 bar

080690 Overflow Valve		Std pkg 1		Thread: M14-1.5	Calibrated: Yes
					
080784 Overflow Valve		Std pkg 1		Hose connection: 6 mm Pressure: 1.5-2 bar	
Aluminium. Can be used w/ petrol & E85.					
					
080785 Overflow Valve		Std pkg 1		Hose connection: 8 mm Pressure: 1.5-2 bar	
Can be used w/ petrol & E85.					
					
080786 Overflow Valve		Std pkg 1		Hose connection: 10 mm Pressure: 1.5-2 bar	
Can be used w/ petrol & E85.					
					
081111 Overflow Valve		Std pkg 1		Hose connection: 12 mm Pressure: 1.5-2 bar	
					

JOINTS

ANGLE

	HC-CARGO	Std pkg	Thread	
	080629	Pkg. 1	M6x1	Type AS w/ threaded journal, hex nut and lock pin. DIN 71802.
	080653	Pkg. 5	M5-0.8	Type AS w/ threaded journal, hex nut and lock pin. DIN 71802.
	080654	Pkg. 5	M6x1x10	Type AS w/ threaded journal, hex nut and lock pin. DIN 71802.
	080655	Pkg. 5	M8x1.25	Type AS w/ threaded journal, hex nut and lock pin. DIN 71802.
	080656	Pkg. 1	M10x1.5	Type AS w/ threaded journal, hex nut and lock pin. DIN 71802.
080657	Pkg. 1	M12x1.75	Type AS w/ threaded journal, hex nut and lock pin. DIN 71802.	

FORK BOLTS

	HC-CARGO	Std pkg	OD	Length
	080662	Pkg. 10	6 mm	19.5 mm
	080663	Pkg. 10	8 mm	22 mm
	080664	Pkg. 10	10 mm	29 mm

IN LINE

	HC-CARGO	Std pkg	Thread
	080744	Pkg. 1	M6x1
	080745	Pkg. 1	M8x1

FORK HEADS

	HC-CARGO	Std pkg	Thread	Length	Slot wide
	080863	Pkg. 1	M5	36 mm	5 mm
	080659	Pkg. 1	M6	31 mm	6 mm
	080660	Pkg. 1	M8	42 mm	8 mm
	080661	Pkg. 1	M8	58 mm	8 mm

HOSE NIPPLES

	HC-CARGO	Std pkg	Hose ID	Length
	080274	Pkg. 5	5 mm	26 mm
	080275	Pkg. 5	8 mm	32 mm
	080276	Pkg. 5	10 mm	34 mm

DOUBLE

	HC-CARGO	Std pkg	Bolt size	ID/demister tube connection	Type
Hose type: Normal fuel hose					
	080245	Pkg. 5	8 mm	6 mm	Dual
	080859	Pkg. 5	10 mm	6 mm	Dual
	080246	Pkg. 5	12 mm	8 mm	Dual
	080247	Pkg. 5	14 mm	10 mm	Dual

DIN 7622

	HC-CARGO	Std pkg	Bolt size	ID/demister tube connection	Type
Hose type: Normal fuel hose					
	080795	Pkg. 5	8 mm	4 mm	Single
	080237	Pkg. 5	8 mm	6 mm	Single
	080239	Pkg. 5	10 mm	7 mm	Single
	080678	Pkg. 5	10 mm	8 mm	Single
	080240	Pkg. 5	12 mm	7 mm	Single
	080241	Pkg. 5	12 mm	9 mm	Single
	080679	Pkg. 5	12 mm	10 mm	Single
	080238	Pkg. 5	14 mm	6 mm	Single
	080242	Pkg. 5	14 mm	9 mm	Single
	080243	Pkg. 5	14 mm	11 mm	Single
	080826	Pkg. 5	14 mm	12 mm	Single
	080002	Pkg. 5	16 mm	10 mm	Single
	080003	Pkg. 5	16 mm	12 mm	Single
	080860	Pkg. 5	1/2"	8 mm	Single

T-CONNECTOR

	HC-CARGO	Std pkg	Hose ID
	080836	Pkg. 5	4 mm
	080838	Pkg. 5	6 mm
	080839	Pkg. 5	8 mm

PIPE NIPPLES

	HC-CARGO	Std pkg	Thread
	080269	Pkg. 5	5 mm
	080270	Pkg. 5	6 mm
	080271	Pkg. 5	8 mm
	080272	Pkg. 5	10 mm
	080273	Pkg. 5	12 mm

HOLLOW SCREWS

	HC-CARGO	Std pkg	Thread	Bore	Type
	080575	Pkg. 10	M6-1		Drain bolt
	080251	Pkg. 10	M8-1	4.2 mm	Ordinary
	080001	Pkg. 10	M10-1.25	4 mm	Ordinary
	080253	Pkg. 10	M10-1.5	4 mm	Ordinary
	081116	Pkg. 5	M10-1.5	4 mm	Ordinary
	080252	Pkg. 1	M10-10.1	4 mm	Ordinary
	080254	Pkg. 10	M12-1.5	6 mm	Ordinary
	080255	Pkg. 10	M14-1.5	8 mm	Ordinary
	080256	Pkg. 10	M16-1.5	9 mm	Ordinary
	080812			1/2"-20 UNF	6 mm

DOUBLE

	HC-CARGO	Std pkg	Thread	Bore	Type
	080257	Pkg. 5	M8-1	2 mm	Dual
	080258	Pkg. 5	M14-1.5	8 mm	Dual

EYE UNION

POLYAMID TUBES

	HC-CARGO	Std pkg	Bolt size	ID/Pipe	Type
Hose type: Polyamid hose					
	080627	Pkg. 5	12 mm	8 mm	Single
	080283	Pkg. 5	14 mm	8 mm	Single
	080284	Pkg. 5	14 mm	10 mm	Single

RETAINING RINGS FOR SHAFT AND BORES

LOCK RINGS

EXTERNAL

	HC-CARGO	Std pkg	OD/housing	DIN norm	Material
	191799	Pkg. 100	14 mm	471	Steel spring
	191270	Pkg. 100	15 mm	471	Steel spring
	191816	Pkg. 100	17 mm	471	Steel spring
	191271	Pkg. 100	18 mm	471	Steel spring
	191333	Pkg. 100	19 mm	471	Steel spring
	191272	Pkg. 100	20 mm	471	Steel spring
	191273	Pkg. 100	21 mm	471	Steel spring
	191274	Pkg. 100	22 mm	471	Steel spring
	191481	Pkg. 100	23 mm	471	Steel spring
	191275	Pkg. 100	24 mm	471	Steel spring
	191276	Pkg. 100	25 mm	471	Steel spring
	191914	Pkg. 100	26 mm	471	Steel spring
	191433	Pkg. 100	27 mm	471	Steel spring

CIRCLIPS

	HC-CARGO	Std pkg	OD/housing	DIN norm	Material
	191277	Pkg. 100	3.2 mm	6799	Steel spring
	192707	Pkg. 100	4 mm	6799	Steel spring
	191278	Pkg. 100	6 mm	6799	Steel spring
	191573	Pkg. 100	7 mm	6799	Steel spring
	191279	Pkg. 100	8 mm	6799	Steel spring
	191280	Pkg. 100	9 mm	6799	Steel spring

SPRING PINS

135061 Spring Pin Std pkg 5

For mounting bushing.

	ID: 11.5 mm OD: 14 mm Length: 50 mm	Material: Steel spring Heat treated: Yes DIN norm: 7336 ISO norm: 13337
--	---	--

192814 Spring Pin Std pkg 100

	ID: 8.5 mm OD: 10.5 mm Length: 14 mm	Material: Steel spring Heat treated: Yes Heavy duty: No DIN norm: 7336 ISO norm: 13337
--	--	--

230858 Spring Pin Std pkg 5

	ID: 8 mm OD: 10 mm Length: 25.4 mm	Material: Steel spring Heat treated: Yes DIN norm: 7336 ISO norm: 13337
--	--	--

BRASS OLIVES

	HC-CARGO	Std pkg	OD
	080277	Pkg. 10	4 mm
	080278	Pkg. 10	5 mm
	080279	Pkg. 10	6 mm
	080280	Pkg. 10	8 mm
	080281	Pkg. 10	10 mm
	080282	Pkg. 10	12 mm

TOOLS

HSS DRILLS

TWIST

	HC-CARGO	Std pkg	OD	DIN norm	Material	Type
	210141	Pkg. 10	1 mm	338	High Speed Steel	N
	210142	Pkg. 10	1.5 mm	338	High Speed Steel	N
	210143	Pkg. 10	2 mm	338	High Speed Steel	N
	210144	Pkg. 10	2.5 mm	338	High Speed Steel	N
	210145	Pkg. 10	3 mm	338	High Speed Steel	N
	210146	Pkg. 10	3.3 mm	338	High Speed Steel	N
	210164	Pkg. 10	3.5 mm	338	High Speed Steel	N
	210147	Pkg. 10	4 mm	338	High Speed Steel	N
	210148	Pkg. 10	4.5 mm	338	High Speed Steel	N
	210149	Pkg. 10	5 mm	338	High Speed Steel	N
	210150	Pkg. 10	5.5 mm	338	High Speed Steel	N
	210151	Pkg. 10	6 mm	338	High Speed Steel	N
	210152	Pkg. 10	6.5 mm	338	High Speed Steel	N
	210153	Pkg. 10	7 mm	338	High Speed Steel	N
	210154	Pkg. 10	7.5 mm	338	High Speed Steel	N
	210155	Pkg. 5	8 mm	338	High Speed Steel	N
	210156	Pkg. 5	8.5 mm	338	High Speed Steel	N
	210157	Pkg. 5	9 mm	338	High Speed Steel	N
210158	Pkg. 5	9.5 mm	338	High Speed Steel	N	
210159	Pkg. 5	10 mm	338	High Speed Steel	N	
210160	Pkg. 5	10.5 mm	338	High Speed Steel	N	

ASSORTMENT
210140 Drill Assortment Std pkg 1

Contains 19 drills from 1-10 mm.



Type: HSS

SOLDERING
SOLDER
200838 Solder Std pkg 1

99.3% tin. 0.7% copper. Unleaded.

 OD: 2 mm
Content: 1 kg

200850 Solder Std pkg 1

99.3% tin. 0.7% copper. Unleaded.

 OD: 1 mm
Content: 500 g

SILVER
200790 Ribbon Silver Solder Std pkg 1

125 g.



Width: 6 mm

IRONS
210897 Soldering Iron Std pkg 1

HRT soldering irons are a patented technical innovation. An armoured teating element of very compact design is located in the heart of the tip and compared to the traditional method, this provides: A reduction of energy consumption by 25 to 35 % at equivalent power. 230 V. AC. Soldering capacity: Wires max. 7 mm, metal max. 7 mm. Soldering Tip: HC-CARGO 210903.

 Voltage: 230
Watt: 75

210898 Soldering Iron Std pkg 1

HRT soldering irons are a patented technical innovation. An armoured teating element af very compact design is located in the heart of the tip and compared to the traditional method, this provides: A reduction of energy consump-tion by 25 to 35 % at equivalent power. 230 V. AC. Soldering capacity: Wires max. 9 mm, metal max. 12 mm. Heating Element: HC-CARGO 210901. Soldering Tip: HC-CARGO 210904.



Voltage: 230
Watt: 100

210899 Soldering Iron Std pkg 1

HRT soldering irons are a patented technical innovation. An armoured teating element af very compact design is located in the heart of the tip and compared to the traditional method, this provides: A reduction of energy consump-tion by 25 to 35 % at equivalent power. 230 V. AC. Soldering capacity: Wires max. 12 mm, metal max. 15 mm. Tip: HC-CARGO 210904. Heating element: HC-CARGO 210902.



Voltage: 230
Watt: 125

210910 Soldering Iron Std pkg 1

HRT soldering irons are a patented technical innovation. An armoured teating element af very compact design is located in the heart of the tip and compared to the traditional method, this provides: A reduction of energy consump-tion by 25 to 35 % at equivalent power. 230 V. AC. Soldering capacity: Wires max. 13 mm, metal max. 22 mm. Tip: HC-CARGO 210912. Heating element: HC-CARGO 210911.



Voltage: 230
Watt: 200

211090 Soldering Gun Std pkg 1

Tip: HC-CARGO 211092.



Voltage: 230
Watt: 250

211106 Gas Soldering Iron Std pkg 1

Max. temperature 1371°C when used as a torch. Max. temperatur 510°C, when used for soldering. Tip: HC-CARGO 211107, -108, -109, -110.







SPARE PARTS

210901 Heating Element Std pkg 1 Servicing: HC-CARGO 210898



Voltage: 230
Watt: 100

		EL. SPECIFICATIONS	DIMENSIONS	ADDITIONAL SPECIFICATIONS
210902	Heating Element	Std pkg 1	Servicing: HC-CARGO 210899	
		Voltage: 230 Watt: 125		
210903	Soldering Tip	Std pkg 1	Servicing: HC-CARGO 210897	
				
210904	Soldering Tip	Std pkg 1	Servicing: HC-CARGO 210898, 210899	
				
210911	Heating Element	Std pkg 1	Servicing: HC-CARGO 210910	
		Voltage: 230 Watt: 200		
210912	Soldering Tip	Std pkg 1	Servicing: HC-CARGO 210910	
				
211092	Soldering Tip	Std pkg 1	Servicing: HC-CARGO 211090	
		Voltage: 230 Watt: 250		
211107	Soldering Tip	Std pkg 1	Servicing: HC-CARGO 211106	
				
211108	Chisel Tip	Std pkg 1	Servicing: HC-CARGO 211106	
				

211109 Soldering Tip Std pkg 1 Servicing: HC-CARGO 211106

Wedge-shaped.



211110 Hot Knife Std pkg 1 Servicing: HC-CARGO 211106



WORK GLOVES

LEATHER

	HC-CARGO	Std pkg	Size	Approval	Material	Colour
	200140	Pkg. 12	9	CE	Grain palm leather	Yellow
	200141	Pkg. 12	10	CE	Grain palm leather	Blue
	200142	Pkg. 12	11	CE	Grain palm leather	Yellow
	200526	Pkg. 12	10	CE	Grain palm leather	Red

RUBBER

	HC-CARGO	Std pkg	Size	Approval	Material	Colour
<i>Strong quality. For short-blastning etc.</i>						
	200787	Pkg. 1	9.5	CE	Rubber	Black
	200686	Pkg. 1	10	CE	Rubber	Black
	200888	Pkg. 1	10.5	CE	Rubber	Black

	HC-CARGO	Std pkg	Size	Approval	Material	Colour
	200831	Pkg. 150	7	CE	Nitrile	Blue
	200832	Pkg. 150	8	CE	Nitrile	Blue
	200833	Pkg. 150	9	CE	Nitrile	Blue
	200834	Pkg. 150	10	CE	Nitrile	Blue

	HC-CARGO	Std pkg	Size	Approval	Material	Colour
	200890	Pkg. 10	S	CE	Polyurethan	Grey
	200891	Pkg. 10	M	CE	Polyurethan	Grey
	200892	Pkg. 10	L	CE	Polyurethan	Grey
	200893	Pkg. 10	XL	CE	Polyurethan	Grey
	200897	Pkg. 10	XXL	CE	Polyurethan	Grey

	HC-CARGO	Std pkg	Size	Approval	Material	Colour
	200889	Pkg. 1	7	CE	Polyurethan	Red
	200884	Pkg. 10	8	CE	Polyurethan	Red
	200885	Pkg. 10	9	CE	Polyurethan	Red
	200886	Pkg. 10	10	CE	Polyurethan	Red
	200887	Pkg. 10	11	CE	Polyurethan	Red

COTTON & VINYL

	HC-CARGO	Std pkg	Size	Approval	Material	Colour
	200603	Pkg. 10	6	CE	Cotton	White
	200805	Pkg. 10	8	CE	Cotton	White
	200640	Pkg. 10	10	CE	Cotton	White

	HC-CARGO	Std pkg	Size	Approval	Material	Colour	
	200655	Pkg. 12	8	CE	Nitrile	White/Grey	w/ rib.
	200685	Pkg. 12	10	CE	Nitrile	White/Grey	w/ rib.
	200869	Pkg. 100	10	CE	Vinyl	Transparent	

LATEX

	HC-CARGO	Std pkg	Size	Approval	Material	Colour	
	200687	Pkg. 100	8	CE	Latex		Universal.
	200688	Pkg. 100	9	CE	Latex		Universal.

SAFETY GLASSES

253488 UV Glasses Std pkg 1



Size: One size

PROTECTING MASKS

200127 Protective Face Mask Std pkg 10

Protects against solid and liquid particles. Offers no protection against gases, vapours or oxygen deficiency. Maintenance-free.



Class: FFP2S
Approval: EN149

200144 Protective Face Mask Std pkg 20

Protects against solid particles bigger than 5 mg/m³. Offers no protection against liquid particles, gasses, vapours or oxygen deficiency.



Disposable mask: Yes
Class: FFP1S
Approval: EN149

200624 Protective Face Mask Std pkg 10

Protects against solid particles bigger than 5 mg/m³. Offers no protection against liquid particles, gasses, vapours or oxygen deficiency.



Disposable mask: Yes
Class: FFP2S
Approval: EN149

HAND LAMPS CONVENTIONAL

SPARE PARTS/ACCESSORIES

171573 Neon tube Std pkg 1 Servicing: HC-CARGO 200635

Fluorescent twin tube 11 W. Socket PL-S 4P (2G7).



Watt: 11/830
Lumen: 900

Length: 214 mm

Approval: CE

HAND LAMPS LED

172186 LED Hand Lamp Std pkg 1

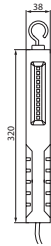

Voltage: 230/240
Watt: 3.5
Lumen: 400

Dim.: 32x3.8x2.7 cm
Length: 320 mm
Cable length: 5 mm
Weight: 615 g

Plug: w/
Tightness norm: IP 20
Approval: CE
Alternativ no.: 200733

172187 LED Hand Lamp Std pkg 1

USB Adapter 230 V: HC-CARGO 181743.



Watt: 3
Lumen: 350

Dim.: 280x48x40 mm

Battery type: Li-ion
Bulb type: LED
Magnet holder: w/
Rechargeable: Yes
Lamp head: Yes
Wall charger 230 V: No
Approval: CE
Alternativ no.: 171999, 172000

172189 LED Hand Lamp Std pkg 1



Watt: 3
Lumen: 300

Dim.: 55x45x215 mm

Battery type: Li-ion
Bulb type: LED
Magnet holder: w/
Rechargeable: Yes
Lamp head: Yes
Wall charger 230 V: Yes
Charger 12 V: Yes
Approval: CE

172190 LED Hand Lamp UK Std pkg 1



Lumen: 300

Dim.: 55x45x215 mm

Battery type: Li-ion
Bulb type: LED
Magnet holder: w/
Rechargeable: Yes
Lamp head: Yes
Wall charger 230 V: Yes
Charger 12 V: Yes
Approval: CE

SPARE PARTS

181743 USB Adapter Std pkg 1 Servicing: HC-CARGO 172187



Voltage: 5
Amp: 0.5

Approval: CE

THREADED INSERTS

	HC-CARGO	Std pkg	Internal thread	External thread	Length	
	192578	Pkg. 10	M10-1	M12-1	10 mm	<i>For Glow Plugs.</i>

WIRE THREAD

	HC-CARGO	Std pkg	Thread	Length	
	200698	Pkg. 10	M4	6 mm	<i>For repairing or creating stronger threads.</i>
	200699	Pkg. 10	M4	8 mm	<i>For repairing or creating stronger threads.</i>
	200700	Pkg. 10	M5	7.5 mm	<i>For repairing or creating stronger threads.</i>
	200701	Pkg. 10	M5	10 mm	<i>For repairing or creating stronger threads.</i>
	200702	Pkg. 10	M6	9 mm	<i>For repairing or creating stronger threads.</i>
	200703	Pkg. 10	M6	12 mm	<i>For repairing or creating stronger threads.</i>
	200706	Pkg. 10	M8	12 mm	<i>For repairing or creating stronger threads.</i>
	200707	Pkg. 10	M8	16 mm	<i>For repairing or creating stronger threads.</i>
	200708	Pkg. 10	M8	20 mm	<i>For repairing or creating stronger threads.</i>
	200709	Pkg. 10	M10	15 mm	<i>For repairing or creating stronger threads.</i>
	200710	Pkg. 10	M10	20 mm	<i>For repairing or creating stronger threads.</i>
	200712	Pkg. 10	M10-1.25	20 mm	<i>For repairing or creating stronger threads.</i>
	200711	Pkg. 10	M12	18 mm	<i>For repairing or creating stronger threads.</i>
	200713	Pkg. 10	M12-1.25	18 mm	<i>For repairing or creating stronger threads.</i>

DIES AND TAPS

MACHINE

	HC-CARGO	Std pkg	Thread	Length	DIN Norm	
	210789	Pkg. 1	M4	63 mm	376	<i>Form A, HSS.</i>
	210790	Pkg. 1	M5	70 mm	376	<i>Form A, HSS.</i>
	210791	Pkg. 1	M6	80 mm	376	<i>Form A, HSS.</i>
	210793	Pkg. 1	M8	90 mm	376	<i>Form A, HSS.</i>
	210813	Pkg. 1	M5	50 mm	8140	<i>For threaded inserts.</i>
	210818	Pkg. 1	M12	80 mm	8140	<i>For threaded inserts.</i>
	210822	Pkg. 1	M12-1.5	70 mm	8140	<i>For threaded inserts.</i>

HOSE CLAMP SCREWDRIVERS

210249 Hose Clamp Screwdriver Std pkg 1

Flexible.



COMBI TOOLS

210050 Multi Tool Std pkg 1

Pulley: HC-CARGO 330716. Multi Tool: HC-CARGO 210051.



210051 Multi Tool Std pkg 1 Servicing: HC-CARGO 210050

Freewheel Pulley: HC-CARGO 330716.



210843 Combi Tool Std pkg 1 Servicing: Bosch Alternators - Visit our web catalogue for further information

33 teeth combitool for the disassembly and assembly of the free wheel pulley. XZN 10x110 mm, w/ 1/2" socket and 22 mm hexagon.



210873 Combi Tool Std pkg 1 Servicing: Magneti Marelli - Visit our web catalogue for further information

For removing and installing of rubber clutch pulley. 200 mm spec. tool + 8x100 mm allen wrench w/ 1/2" socket.



210877 Combi Tool Std pkg 1 Servicing: Bosch - Visit our web catalogue for further information

For removing and installing of rubber clutch pulley. XZN 10x112 mm w/ 1/2" socket and 30/28 mm hexagon.



210909 Combi Tool Std pkg 1 Servicing: Valeo Alternators - Visit our web catalogue for further information

33 teeth combitool for disassembly and assembly of free wheel pulley. Torx 50x110 mm, w/ 1/2" socket and 22 mm hexagon.



210948 Combi Tool Std pkg 1 Servicing: Audi, VW, MB, SEAT, Skoda - Visit our web catalogue for further information

33 teeth combitool for the disassembly and assembly of the free wheel pulley, XZN 10x135 mm, w/ 1/2" socket and 22 mm hexagon.



211048 Combitool MK2 Std pkg 1 Servicing: Generators - Visit our web catalogue for further information



	EL. SPECIFICATIONS	DIMENSIONS	ADDITIONAL SPECIFICATIONS
211049 Combitool MK3 	Std pkg 1		Servicing: Generators - Visit our web catalogue for further information
211081 Combi Tool 	Std pkg 1		Servicing: Valeo - Visit our web catalogue for further information <i>For removing and installing of rubber clutch pulley. XZN 10x128 mm w/ 1/2" socket and 28/19 mm hexagon.</i>
211129 Combi Tool set for Freewheel Pulley 	Std pkg 1		Servicing: Audi, BMW, Citroen, Chrysler, Fiat, Ford, Mercedes, Mazda, Opel, Peugeot, Porsche, Renault, Saab, Seat, Skoda, Toyota - Visit our web catalogue for further information <i>For removing/installing of Freewheel Pulley. Combi Tool: HC-CARGO 211130-211152.</i>
211130 Combi Tool 	Std pkg 1		Servicing: HC-CARGO 211129LL <i>Combi Tool 36R*H17*4 pins.</i>
211131 Combi Tool 	Std pkg 1		Servicing: HC-CARGO 211129 <i>Combi Tool H38*3 pins.</i>
211132 Combi Tool 	Std pkg 1		Servicing: HC-CARGO 211129 <i>Combi Tool H22.1*H28.1.</i>
211133 Combi Tool 	Std pkg 1		Servicing: HC-CARGO 211129 <i>Combi Tool H19*H28.</i>

211134 Combi Tool Std pkg 1 Servicing: HC-CARGO 211129

*Combi Tool H21*H28.*



211135 Combi Tool Std pkg 1 Servicing: HC-CARGO 211129

*Combi Tool H22*33T.*



211136 Combi Tool Std pkg 1 Servicing: HC-CARGO 211129

*Combi Tool H15*33T(18R).*



211137 Combi Tool Std pkg 1 Servicing: HC-CARGO 211129

*Combi Tool H15*33T(19.7R).*



211138 Combi Tool Std pkg 1 Servicing: HC-CARGO 211129

*Combi Tool H17*35 mm.*



211139 Combi Tool Std pkg 1 Servicing: HC-CARGO 211129

*Combi Tool H22*30 mm.*



211140 Combi Tool Std pkg 1 Servicing: HC-CARGO 211129

Combi Tool 1/2"DRx1/2"adapter.



EL. SPECIFICATIONS		DIMENSIONS	ADDITIONAL SPECIFICATIONS
211141 Combi Tool	Std pkg 1	Servicing: HC-CARGO 211129	
<i>Combi Tool 12R*75 mm*M10.</i>			
			
211142 Combi Tool	Std pkg 1	Servicing: HC-CARGO 211129	
<i>Combi Tool 12R*75 mm*M8.</i>			
			
211143 Combi Tool	Std pkg 1	Servicing: HC-CARGO 211129	
<i>Combi Tool 12R*75 mm*H10.</i>			
			
211144 Combi Tool	Std pkg 1	Servicing: HC-CARGO 211129	
<i>Combi Tool 12R*75 mm*H8.</i>			
			
211145 Combi Tool	Std pkg 1	Servicing: HC-CARGO 211129	
<i>Combi Tool 12R*75 mm*T50.</i>			
			
211146 Combi Tool	Std pkg 1	Servicing: HC-CARGO 211129	
<i>Combi Tool 12R*75 mm*T40.</i>			
			
211147 Combi Tool	Std pkg 1	Servicing: HC-CARGO 211129	
<i>Combi Tool 16R*64 mm*M10.</i>			
			

211148 Combi Tool Std pkg 1 Servicing: HC-CARGO 211129

*Combi Tool 3/8"DR*M10*31T.*



211149 Combi Tool Std pkg 1 Servicing: HC-CARGO 211129

*Combi Tool 1/2"DR*110L*M10.*



211150 Combi Tool Std pkg 1 Servicing: HC-CARGO 211129

*Combi Tool 1/2"DR*113L*M10.*



211151 Combi Tool Std pkg 1 Servicing: HC-CARGO 211129

*Combi Tool 1/2"DR*113L*T50.*



211152 Combi Tool Std pkg 1 Servicing: HC-CARGO 211129

*Combi Tool 1/4"DR*10 mm/35L.*



211164* Combi Tool Std pkg 1 Servicing: Volvo - Visit our web catalogue for further information



LAMBDA SENSOR TOOL

210763 Oxygen Sensor Tool Std pkg 1

Special tool for mounting/removing oxygen sensors. M18.



Thread size: M18

Thread type: mm

REMOVE/INSTALL		
INTERNAL EXTRACTORS		
210777 Internal Extractor Std pkg 1 <i>Suitable for extraction of needle/roller bearings, ball bearings, brass sleeves and flame arresters.</i>		Dia.: 5-7 mm
210778 Internal Extractor Std pkg 1 <i>Suitable for extraction of needle/roller bearings, ball bearings, brass sleeves and flame arresters.</i>		Dia.: 7-9 mm
210779 Internal Extractor Std pkg 1 <i>Suitable for extraction of needle/roller bearings, ball bearings, brass sleeves and flame arresters.</i>		Dia.: 9-12 mm
210780 Internal Extractor Std pkg 1 <i>Suitable for extraction of needle/roller bearings, ball bearings, brass sleeves and flame arresters.</i>		Dia.: 10-13 mm
210781 Internal Extractor Std pkg 1 <i>Suitable for extraction of needle/roller bearings, ball bearings, brass sleeves and flame arresters.</i>		Dia.: 13-17 mm
210782 Internal Extractor Std pkg 1 <i>Suitable for extraction of needle/roller bearings, ball bearings, brass sleeves and flame arresters.</i>		Dia.: 14-19 mm
210786 Internal Extractor Std pkg 1 <i>Suitable for extraction of needle/roller bearings, ball bearings, brass sleeves and flame arresters.</i>		Dia.: 25-30 mm

UNIVERSAL PULLER

210868 Universal Puller Std pkg 1

w/ slender hooks. Min.-max. 10-80 mm.



SOLENOID TOOLS

210686 Solenoid Tool Std pkg 1

Makes opening and closing Bosch, Bosch industrial, hitachi and mitsubishi passenger car "crimp cap" -solenoids a fast and simple press operation. Complete set in carrying box.



SOLENOID COIL

210567 Mounting Sleeve Std pkg 1



DRIVE TOOLS

210867 Assembly Tool Std pkg 1

Tool for renewing of new type Bosch starter. For mounting of repair kit: HC-CARGO 136856. Mounting Pin: HC-CARGO 210995, 210996.



210995 Mounting Pin Std pkg 1 Servicing: HC-CARGO 210867



OD: 13 mm
Length: 70 mm

210996 Mounting Pin Std pkg 1 Servicing: HC-CARGO 210867



OD: 13 mm
Length: 70 mm

ADJUSTMENT TOOLS

090153 Test Kit Std pkg 1 Servicing: Opel, VAG, Ford, Volvo, (TDI), Japanese applications - Visit our web catalogue for further information

Contains: Micrometers O.D. 41 mm, 0.01-5 mm. Mount micrometer: lenght 38 mm. Extension for micrometer: lenght 42 mm. Extension for micrometer: lenght 101 mm. Extender w/ M8-1. Extension cradle M10-1. align tool (VAG). dorn (VAG).



TEST INJECTION PIPES

	HC-CARGO	Std pkg	Screw device	Wall thicknes	Dim.
	090255	Pkg. 1	12&14 mm	2 mm	6 × 2 × 600 mm
	090257	Pkg. 1	14&14 mm	1.5 mm	6 × 3 × 600 mm

SPECIAL TOOLS

090133 Injector Tester Std pkg 1

Filter: HC-CARGO 090259. Quick Release Tool: HC-CARGO 090239.



Dim.: 200x516 mm
 Piston cycle: 10.5
 OD: 14 mm
 Fuel cap: 3.2 l
 Pressure: 0-40 mPa
 Test quantity:
 1600 mm²

090239 Quick Release Tool Std pkg 1 Servicing: HC-CARGO 090133

Quik connector to the nozzle tester 12x1.5 mm/14x1.5 mm.



090241 Wrench Std pkg 1 Servicing: Bosch VE pump, Audi, BMW - Visit our web catalogue for further information

For screwhead O.D. 7.5 mm.



090269 Glow Plug Tool Std pkg 1

Tool set for the drilling of broken off CDI glow plugs M10-1. Contains: torx top E10, 3/8". Single-purpose drill w/ counterbore I.D. 9 mm turned from 5.4 to 4 mm (HC-CARGO 090273.) Special retainer for single-purpose drill. Drill and extraction housing for glow plugs locked.



090273 Glow Plug Drill Std pkg 1 Servicing: HC-CARGO 090269

9 mm to 5.4 mm to 4 mm.

090372 Hose Press Std pkg 1

Presses from 6-18 mm OD.

090409 CR Return Flow Meter Std pkg 1

For measuring af back lift on CR nozzles.



SPARE PARTS

090259 Glass Bowl Kit Std pkg 1 Servicing: HC-CARGO 090133

AAE060-01 = plastic bottle-oil Diameter 12 mm Throat high: 7 mm Throat: 1.5 mm AAE060-03 = filter Diameter 12 mm Throat high: 11.5 mm Throat: 1.5 mm



TPMS

211155 TPMS Programming Tool Std pkg 1

Kit contains: Programming tool, 4 sensors w/ valves (HC-CARGO 211159), Charger, User Manual, Adapter (HC-CARGO 211157), USB cable.

 Voltage: 5
 Amp: 1
 Miliamp: Max 90

 Dim.: 228x105.5x49.6 mm
 Temp./battery: -10°C-55°C
 Temp./charging: -10°C-35°C
 Weight: 475 g

 Type: LCD
 Charging time: 2.5 h
 Power supply: Built-in Lithium Battey

211156 Adapter For ATEQ VT55/VT56 Std pkg 1 Servicing: ATEQ VT55 / VT56 - Visit our web catalogue for further information

 Voltage: 5±0.3
 Miliamp: Max 15

 Dim.: 84.8x83.8x66.2 mm
 Temp. area: -20 - +60 °C
 Weight: 125 g

		EL. SPECIFICATIONS	DIMENSIONS	ADDITIONAL SPECIFICATIONS
211157	Adapter for TX-PT001	Std pkg 1	Servicing: HC-CARGO 211155, 211160, 211161	
		Voltage: 30 Amp: 1	Dim.: 85x48.5x62.9 mm Temp. area: -20 - +60 °C Weight: 56 g	
211158	TPMS Sensor US	Std pkg 1	Servicing: HC-CARGO 211155 ATEQ VT55 / VT56	
<i>TPMS Service Kit: HC-CARGO 211162.</i>				
		Voltage: 3 Frequency: 315 MHz	Dim.: 78.5x30.8x19 mm Adjustable: 0-40° Temp. area: -40-+105 °C Weight: 46 g	Power supply: Built-in Lithium Battery
211159	TPMS Sensor EU	Std pkg 1	Servicing: HC-CARGO 211155 ATEQ VT55 / VT56	
<i>TPMS Service Kit: HC-CARGO 211162.</i>				
		Voltage: 3 Frequency: 433 MHz	Dim.: 78.5x30.8x19 mm Adjustable: 0-40° Temp. area: -40-+105 °C Weight: 46 g	Power supply: Built-in Lithium Battery
211160	TPMS Sensor US	Std pkg 1	Servicing: HC-CARGO 211155 ATEQ VT55 / VT56	
<i>TPMS Service Kit: HC-CARGO 211163.</i>				
		Voltage: 3 Frequency: 315 MHz	Dim.: 80.65x55.28x26.15 mm Adjustable: 0-40° Temp. area: -40-+105 °C Weight: 38 g	Power supply: Built-in Lithium Battery
211161	TPMS Sensor EU	Std pkg 1	Servicing: HC-CARGO 211155 ATEQ VT55 / VT56	
<i>TPMS Service Kit: HC-CARGO 211163.</i>				
		Voltage: 3 Frequency: 433 MHz	Dim.: 80.65x55.28x26.15 mm Adjustable: 0-40° Temp. area: -40-+105 °C Weight: 38 g	Power supply: Built-in Lithium Battery
211162	TPMS Valve Stem	Std pkg 1	Servicing: HC-CARGO 211158, 211159	
				
211163	TPMS Valve	Std pkg 1	Servicing: HC-CARGO 211160, 211161	
				

WORKS AND TEST EQUIPMENT

ANTIFREEZE HYDROMETERS

210052 Antifreeze Tester Std pkg 1

Glykomat, for ethyleneglycol.



210053 Antifreeze Tester Std pkg 1

Gefo Coldomat, for ethyleneglycol.



210771 Refractometer Std pkg 1

Ethylene glycol, propylene glycol, battery liquid, windshield washer fluid. G11, G12, G13.



BATTERY ACID HYDROMETERS

210134 Battery Acid Tester Std pkg 1



TEST PLUGS

210054 Test Plug Std pkg 1

The test lead makes it possible for one person alone to control the socket from the drivers seat.



Length/test cable: 5 m

Plug type: 7, 12N, 12, 1724, 72577
Test cable incl.: Yes

210758 Test Plug Std pkg 1

Service: Commercial vehicles w/ w/o CAN-BUS/check control system - Visit our web catalogue for further information

The test lead makes it possible for one person alone to control the socket from the drivers seat.



Length/test cable: 5 m

Plug type: 13, 12, 11446, 72570, 7, 12N,
12, 1724, 72577, 7/13, Multicon, 12
Can-Bus: Yes
Test cable incl.: Yes

		EL. SPECIFICATIONS	DIMENSIONS	ADDITIONAL SPECIFICATIONS
210869	Test Plug	Std pkg 1		Plug type: 7, 12N, 12, 1724, 72577
				
210871	Test Plug	Std pkg 1		Plug type: 13, 12, 11446, 72570
				
210872	Test Plug	Std pkg 1		
<i>The test lead of 5 m allows one person to check the socket from the drivers seat.</i>				
			Length/test cable: 5 m	Plug type: 13, 12, 11446, 72570 Test cable incl.: Yes
211059	Adaptor	Std pkg 1	Servicing: HC-CARGO 211058 for check of 7 pole and 7/13 multicon sockets	
				
TRAILER LIGHT TESTER				
211058	Trailer Socket Tester	Std pkg 1	Servicing: Commercial vehicles w/ w/o CAN-BUS/check control system - Visit our web catalogue for further information	
<i>Accessories: HC-CARGO 211059.</i>				
			Length/test cable: 5 m	Plug type: 13, 12, 11446, 72570 Can-Bus: Yes Test cable incl.: Yes
211113	Trailer Lighttester 7-pole	Std pkg 1		
<i>Used for testing, fault finding and repair of light installation of trailers, caravans and cars w/o CAN-BUS. Provided w/ built in battery and charger.</i>				
			Dim.: 225x120 mm	Plug type: 7, 12, 1724, 72577 Colour: White Material: ABS plastic Can-Bus: No Warning lamp: w/ Batteries incl.: Yes
211114	Trailer Light Tester	Std pkg 1		
<i>Testing of light installation on a trailer and caravans w/o CAN-BUS. w/ built-in battery. Comes w/ charger. 13 poles.</i>				
			Dim.: 225x120 mm	Plug type: 13, 12, 4091, 72570 Colour: White Material: ABS plastic Can-Bus: No Warning lamp: w/ Batteries incl.: Yes

OXYGEN SENSOR TESTER

210762 Oxygen Sensor Tester Std pkg 1

Shows if the oxygen sensor is active.



BLADES

210699 Blades Std pkg 1



ID: 3.2 mm
OD: 7.86 mm
Thread: 0.4

DIGITAL MULTIMETER

210977 Digital Multimeter Std pkg 1

3.5 digital LCD display. Battery: HC-CARGO 200742. Test Lead: HC-CARGO 210980.



Voltage/AC: 200V/600V
Voltage/DC: 200mV/2/20 /200/600 V
Amp/DC: 0.2/2/20 /200mA/15A
Ohm: 200 hm/2/20 /200/2000 KOhm

Dim.: 74x145x40 mm
Reading/max: 1999

Colour: Black
Material: Plastic
HFE transistor: Yes
Batteries incl.: Yes
Battery check: Yes
Diode check: Yes
Test cable incl.: Yes
Approval: CE

211065 AC/DC Clamp Multimeter Std pkg 1 Servicing: CE/LVD CAT III 600 V - Visit our web catalogue for further information

3 3/4 Digits compact clamp and multimeter for measuring ampere as well as DC & AC voltage. Test Lead: HC-CARGO 210980.



Voltage/AC: 4/40/400V
/±1.0%, 40/400mV /600V±1.5%
Amp/AC: 400A±2.0%, 1000A±2.5%
Voltage/DC: 400 mV/4/40 /400 V±0.5%, 40 mV/600 V±0.8%
Amp/DC: 400A±1.5%, 1000A±2%
Ohm: 400ohm/4/40 /400kohm /4Mohm±1.0%, 40Mohm±2%
Frequency: 1Hz--10MHz±0.1%

Dim.: 220x64x35 mm
Temp.: -20 - +150 °C
Reading/max: 4000
Capacity: 40nF±3%,
400nF /4µF±2.5%,
40µF±5%,
400/4000µF±20%

Batteries incl.: Yes
Battery check: Yes
Diode check: Yes
Continuity test: Yes
Reading: Yes
LCD display: Yes
C°/F° selection: Yes
Auto power off: Yes
Approval: CE

211101 Smart Multimeter SD-5803 Std pkg 1

Test leads: HC-CARGO 210980. Fuse: HC-CARGO 192861.



Voltage/AC: 4/40/400V±0.8%,
400mV/600V±1.2%
Voltage/DC: 4/40/400 V±0.5%,
600 V±0.8%
Ohm: 400ohm/4/40 /400kohm/
4Mohm±1%, 40Mohm±2%
Frequency: 1Hz--500kHz±0.1%

Dim.: 152x78x33 mm
Duty cycle: 0.1%--
99.9±2.5%
Temp.: 0 - +40 °C
Reading/max: 4000
Capacity: 40nF/400nF/4µF
/40µF±3%, 400µF /4000µF±20%

Batteries incl.: Yes
Diode check: Yes
Continuity test: Yes
Reading: Yes
Test cable incl.: Yes
LCD display: Yes
Smart function: Yes
Auto power off: Yes
Approval: CE

211102 Smart Multimeter SD-5813 Std pkg 1

CE/LVD CAT III 500 V. Test cable: HC-CARGO 210980. Fuses: HC-CARGO 190285, 192861.



Voltage/AC: 4/40/400V±0.8%,
400mV/500V±1.2%
Amp/AC: 40/400mA±2.0%,
4/10A±2.5%
Voltage/DC: ±400 mV/4/40 /400 V±0.5%, ± 500 V±0.8%
Amp/DC: 40/400mA±1.2%,
4/10A±2.0%
Ohm: 400ohm/4/40/400kohm/
4Mohm±1.0%, 40Mohm±2.0%
Frequency: 1Hz--500kHz±0.1%

Dim.: 165x83x37 mm
RPM: (0-10.000RPM)±0.1%
Duty cycle: 0.1%--
99.9±2.0%
Dwell angle: ±2%
Temp.: -50 - +150 °C
Reading/max: 4000
Capacity: 40nF±3%,
400nF /4µF±2.5%,
40µF±5%, 400/4000µF±20%

Batteries incl.: Yes
Battery check: Yes
Diode check: Yes
Continuity test: Yes
Reading: Yes
Test cable incl.: Yes
LCD display: Yes
C°/F° selection: Yes
Smart function: Yes
Auto power off: Yes
Approval: CE

SPARE PARTS
210980 Test Lead Std pkg 1 Servicing: HC-CARGO 210977, 211065, 211101, 211102

INFRARED THERMOMETER
211128 Infrared Thermometer Std pkg 1

Used for measurement of surface temperatures which are not suitable for physical contact: 1. high voltage areas, 2. high temperature non-touchable objects. 3. moving objects.

 Dim.: 153x101x143 mm
 Temp.: -50 - +380 °C

 Colour: Yellow/black
 Batteries incl.: No
 Reading: Yes
 LCD display: Yes
 C°/F° selection: Yes
 Auto power off: Yes

ACCESSORIES
ALLIGATOR CLIPS
211013 Alligator Clip Std pkg 10

Connexion for test probes.

Amp: 5

 Jaw opening: 11
 Length: 50 mm

 Type: Positive
 Colour: Red

211014 Alligator Clip Std pkg 10

Connexion for test probes.

Amp: 5

 Jaw opening: 11
 Length: 50 mm

 Type: Negative
 Colour: Black

TEST BOX
210878 Tester Std pkg 1 Servicing: Magneti Marelli, Ford - Visit our web catalogue for further information

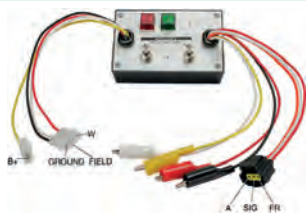
To simulate the function of the vehicle computer.

 Colour: Black
 Material: Plastic

211126 Alternator Tester Std pkg 1 Servicing: BSS & LIN - Visit our web catalogue for further information

To simulate the function of the vehicle computer.

Voltage/DC: 12

TEST LEAD
210845 Test Lead

Std pkg 1 Servicing: Mitsubishi, Hitachi, Mazda - Visit our web catalogue for further information

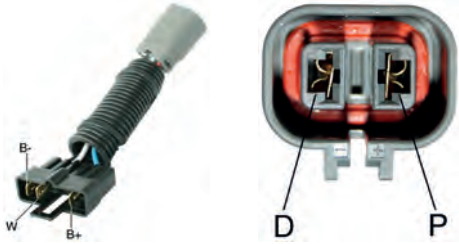
For testing fo alternators w/ P-D terminals.

Plug type: 2

210846 Alternator Test Lead

Std pkg 1 Servicing: Denso - Visit our web catalogue for further information

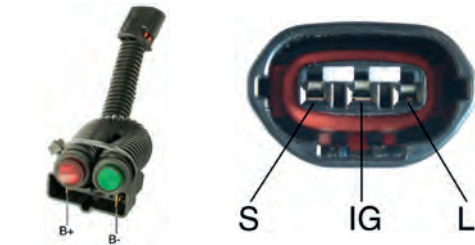
For testing alternator w/ IG-S-L terminals.

Plug type: 3

SLIDING GAUGE
211045 Vernier Gauge

Std pkg 1

Jaw L. 40 mm. Reading 0.05 mm.

 Length: 150 mm
 Measuring range: 0-150

BATTERY TESTER
211040 Battery Tester

Std pkg 1



Voltage: 12-24

Dim.: 160x43x15 mm

211041 Battery Tester

Std pkg 1

Easy to read digital display.

Voltage: 12/24

Dim.: 180x30x18 mm

211103 Battery Tester

Std pkg 1

Heavy duty copper plated clamps and nickel/chrome plated steel case.

 Voltage: 6-12
 Amp: 0-100

211124 Battery/Starting/Charging System Analyzer
Std pkg 1

Functions: 1. Check of battery condition. 2. Check of the cold cranking amps of the battery. 3 Check of the starting system. 4. Check of the charging system.



Voltage: 12
Amp/hour: 25-200

Dim.: 119x68x19 mm

Approval: CE

CIRCUIT TESTER
210212 Circuit Tester
Std pkg 1

Bulb (18 V, 3 W): HC-CARGO 170643.



Voltage/DC: 6-24

Material: Chromed brass

211042 Circuit Tester
Std pkg 1

Voltage/DC: 2.8-48

Dim.: 160x22x16 mm

211083 Power Probe II
Std pkg 1

Features: testing of polarity and continuity. Activating components by post. or neg. voltage. Tester trailer lights and connections. Locate short-circuits. Rocker switch: HC-CARGO 211123.



Voltage/DC: 6-24

Length/test cable: 6 m

Test cable incl.: Yes

211094 Circuit Tester
Std pkg 1

Wire 1.2 m w/ HD alligator clips and bulb.



Voltage/DC: 6/12

211119 Circuit Tester
Std pkg 1

Voltage/DC: 3-48

Warning lamp: w/

211122 Circuit Tester Std pkg 1

Computersafe wire 1.2 m w/ alligator clips. Safely tests standard primary automotive circuits and onboard computer controlled electrical system.



Voltage/DC: 3-15

Warning lamp: w/
Approval: CE

W/VOLTMETER

211097 Circuit Tester Std pkg 1

Features: test light. Short circuit indicator. Continuity tester. Indicator for poor ground connection. Short circuit protection. Voltmeter. 6 m cable. Rocker Switch HC-CARGO 211123. Power Probe: HC-CARGO 211118.



Voltage/DC: 12-24

Colour: Red

SPARE PARTS

170643 Bulb Pinol Std pkg 10 Servicing: HC-CARGO 210212, 210212Z, 211153



Voltage: 18
Watt: 3

211123 Rocker Switch Std pkg 1 Servicing: HC-CARGO 211083, 211097



Voltage: 12/24

Type/terminal: Flat
Terminals: 3

ACCESSORIES

211117 Lead Set Std pkg 1

Contains: 1-3-6 ft. stackable leads. Banana jack adapter. Large piercing probe. Small piercing probe. Alligator clip adapter. Case w/organizer. Probe tip. Male/male adapter. Female/female adapter.



211118 Power Probe Std pkg 1 Servicing: HC-CARGO 211097

Tip. 3".



SHORT CIRCUIT SEEKER

211091 Short Circuit Seeker Std pkg 1

The ECT 2000 makes locating short and open circuits easier than ever before. Its advanced digital intelligence puts it above all others. The ECT 2000 detects and alerts you immediately whether a circuit is shorted or open.



A/C PARTS

VALVE CORE

211027 Valve Core Tool Std pkg 1





211028 Valve Core Tool Std pkg 1



BITS 1/4"



SLOTTED

39 MM

	HC-CARGO	Std pkg	Size	Length
 	210708	Pkg. 10	5.5x1 mm	39 mm
	210709	Pkg. 10	8x1.2 mm	39 mm
	210710	Pkg. 10	8x1.6 mm	39 mm

PH

25 MM

	HC-CARGO	Std pkg	Type	Length
 	210759	Pkg. 10	2	25 mm
	210712	Pkg. 10	3	25 mm

32 MM

	HC-CARGO	Std pkg	Type	Length
 	210713	Pkg. 1	4	32 mm
	210744	Pkg. 10	4	32 mm

50 MM					
	HC-CARGO	Std pkg	Type	Length	
 	210750	Pkg. 10	1	50 mm	
	210853	Pkg. 10	2	50 mm	
	210751	Pkg. 10	3	50 mm	
PZ					
25 MM					
	HC-CARGO	Std pkg	Type	Length	
 	210860	Pkg. 10	2	25 mm	
	210715	Pkg. 10	3	25 mm	
	210716	Pkg. 1	4	32 mm	
50 MM					
	HC-CARGO	Std pkg	Type	Length	
 	210740	Pkg. 10	2	50 mm	
TORX					
25 MM					
	HC-CARGO	Std pkg	Type	Length	
 	210723	Pkg. 10	T15	25 mm	
	210724	Pkg. 10	T20	25 mm	
	210725	Pkg. 10	T25	25 mm	
	210726	Pkg. 10	T27	25 mm	
	210727	Pkg. 10	T30	25 mm	
W/ BORING					
	HC-CARGO	Std pkg	Type	Length	
 	210729	Pkg. 10	T40	25 mm	
HEX					
	HC-CARGO	Std pkg	Type	Length	
 	210753	Pkg. 1	4	50 mm	
	210754	Pkg. 1	5	50 mm	
BIT HOLDER					
W/RETAINING RING					
	HC-CARGO	Std pkg	Size	Length	
 	210755	Pkg. 1	57x6.3 mm	57 mm	

MAGNETIC						
	HC-CARGO	Std pkg	Size	Length		
 	210757	Pkg. 1	75x6.3 mm	75 mm		
BITS 5/16"						
SLOTTED						
	HC-CARGO	Std pkg	Size	Length		
 	210741	Pkg. 1	12x2 mm	41 mm		
PH						
	HC-CARGO	Std pkg	Type	Length		
 	210742	Pkg. 10	2	32 mm		
	210743	Pkg. 10	3	32 mm		
TORX						
	HC-CARGO	Std pkg	Type	Length		
 	210745	Pkg. 1	T25	35 mm		
	210905	Pkg. 1	T40	35 mm		
	210747	Pkg. 1	T45	35 mm		
	210748	Pkg. 1	T50	35 mm		
FASTENING PARTS						
TAPPING SCREWS						
POZIDRIV						
FLAT HEAD W/GIMLET POINT						
	HC-CARGO	Std pkg	Dim.	Spanner size	ISO norm	DIN norm
	192122	Pkg. 200	4.2x13 mm	8	7050	7982
	192123	Pkg. 200	4.8x16 mm	8	7050	7982
PAN HEAD						
	HC-CARGO	Std pkg	Dim.	Spanner size	ISO norm	DIN norm
	191753	Pkg. 200	2.9x16 mm	4	7049	7981C
	191798	Pkg. 200	2.9x19 mm	4	7049	7981C
	192006	Pkg. 200	2.9x9.5 mm	4	7049	7981C
	190361	Pkg. 200	3.5x16 mm	6	7049	7981C
	190362	Pkg. 200	3.5x19 mm	6	7049	7981C
	190360	Pkg. 500	3.5x9.5 mm	6	7049	7981C
	192554	Pkg. 200	4.2x13 mm	8	7049	7981C
	190367	Pkg. 200	4.2x16 mm	8	7049	7981C
	190368	Pkg. 200	4.2x19 mm	8	7049	7981C
	190371	Pkg. 200	4.2x25 mm	8	7049	7981C
	190366	Pkg. 200	4.2x9.5 mm	8	7049	7981C
	190373	Pkg. 200	4.8x19 mm	10	7049	7981C

PAN HEAD W/GIMLET POINT

	HC-CARGO	Std pkg	Dim.	Spanner size	ISO norm	DIN norm
	192114	Pkg. 200	3.5x13 mm	6	7049	7981
	190372	Pkg. 200	4.8x13 mm	10	7049	7981C

HEX

W/FLANGE

	HC-CARGO	Std pkg	Dim.	Spanner size	DIN norm
	191988	Pkg. 100	6.3x19 mm	10 mm	7976C

HEX SCREWS

FULLY THREADED

EL-PLATED

	HC-CARGO	Std pkg	Dim.	Spanner size	ISO norm	DIN norm
	192508	Pkg. 500	M4x14 mm	7 mm	4017	933
	191293	Pkg. 200	M4x25 mm	7 mm	4017	933
	192753	Pkg. 200	M5x10 mm	8 mm	4017	933
	192255	Pkg. 200	M5x12 mm	8 mm	4017	933
	191789	Pkg. 200	M5x14 mm	8 mm	4017	933
	190469	Pkg. 200	M5x16 mm	8 mm	4017	933
	190470	Pkg. 200	M5x20 mm	8 mm	4017	933
	190474	Pkg. 200	M5x40 mm	8 mm	4017	933
	191615	Pkg. 200	M5x50 mm	8 mm	4017	933
	192588	Pkg. 200	M5x6 mm	8 mm	4017	933
	191644	Pkg. 200	M6x10 mm	10 mm	4017	933
	192418	Pkg. 200	M6x12 mm	10 mm	4017	933
	190477	Pkg. 200	M6x16 mm	10 mm	4017	933
	190478	Pkg. 200	M6x20 mm	10 mm	4017	933
	190479	Pkg. 200	M6x25 mm	10 mm	4017	933
	190480	Pkg. 200	M6x30 mm	10 mm	4017	933
	192063	Pkg. 200	M6x35 mm	10 mm	4017	933
	190482	Pkg. 200	M6x40 mm	10 mm	4017	933
	191536	Pkg. 100	M6x45 mm	10 mm	4017	933
	191854	Pkg. 200	M6x50 mm	10 mm	4017	933
	191645	Pkg. 200	M6x65 mm	10 mm	4017	933
	190492	Pkg. 200	M8x16 mm	13 mm	4017	933
	190493	Pkg. 200	M8x20 mm	13 mm	4017	933
	190494	Pkg. 200	M8x25 mm	13 mm	4017	933
	190495	Pkg. 200	M8x30 mm	13 mm	4017	933
	192251	Pkg. 200	M8x40 mm	13 mm	4017	933
	192752	Pkg. 100	M10x12 mm	17 mm	4017	933
	190506	Pkg. 200	M10x30 mm	17 mm	4017	933
	190508	Pkg. 200	M10x40 mm	17 mm	4017	933
	192248	Pkg. 200	M10x50 mm	17 mm	4017	933
	192407	Pkg. 200	M12x50 mm	19 mm	4017	933
	192404	Pkg. 100	1/4" UNFx7/8"	7/16"	4017	933
192778	Pkg. 200	UNC 5/16"x3/4"	1/2"	4017	933	

EL-PLATED W/ESLOK							
	HC-CARGO	Std pkg	Dim.	Spanner size	ISO norm	DIN norm	
	191900	Pkg. 200	M5x16 mm	8 mm	4017	933	
PARTLY THREADED							
EL-PLATED							
	HC-CARGO	Std pkg	Dim.	Spanner size	ISO norm	DIN norm	
	191294	Pkg. 200	M6x80 mm	10 mm	4014	931	
	190499	Pkg. 200	M8x50 mm	13 mm	4014	931	
	190500	Pkg. 200	M8x60 mm	13 mm	4014	931	
	192252	Pkg. 200	M8x70 mm	13 mm	4014	931	
	192253	Pkg. 200	M8x80 mm	13 mm	4014	931	
	190511	Pkg. 100	M10x60 mm	17 mm	4014	931	
	192249	Pkg. 200	M10x70 mm	17 mm	4014	931	
	190510	Pkg. 100	M10x50 mm	17 mm	4014	931	
FLANGE							
	HC-CARGO	Std pkg	HC-CARGO	Std pkg	Dim.	Spanner size	DIN norm
	191326	Pkg. 200	B191326	Pkg. 2000	M4x10 mm	7 mm	6921
	191327	Pkg. 200	B191327	Pkg. 2000	M4x12 mm	7 mm	6921
			B191328	Pkg. 2000	M4x14 mm	7 mm	6921
			B191329	Pkg. 2000	M4x16 mm	7 mm	6921
	191330	Pkg. 200	B191330	Pkg. 2000	M4x18 mm	7 mm	6921
			B191651	Pkg. 2000	M4x20 mm	7 mm	6921
			B191514	Pkg. 4000	M4x28 mm	7 mm	6921
			B191325	Pkg. 4000	M4x8 mm	7 mm	6921
	191545	Pkg. 100			M5x12 mm	8 mm	6921
	191546	Pkg. 100			M5x16 mm	8 mm	6921
	191772	Pkg. 100	B191867	Pkg. 2000	M5x20 mm	8 mm	6921
			B191792	Pkg. 2000	M5x30 mm	8 mm	6921
	192425	Pkg. 100			M6x20 mm	10 mm	6921
	192416	Pkg. 100			M6x10 mm	10 mm	6921
	191987	Pkg. 100			M8x16 mm	13 mm	6921
	W/ ESLOK						
	HC-CARGO	Std pkg	Dim.	Spanner size	DIN norm		
	192565	Pkg. 200	M4x14 mm	7 mm	6921		
	192567	Pkg. 200	M5x12 mm	8 mm	6921		
	192568	Pkg. 200	M5x16 mm	8 mm	6921		
W/SPRING WASHER							
	HC-CARGO	Std pkg	Dim.	Spanner size			
	192536	Pkg. 100	M5x20 mm	7 mm			
	192550	Pkg. 100	M5x20 mm	7 mm			

MACHINE SCREWS

POZIDRIV

FLAT HEAD



HC-CARGO	Std pkg	Dim.	ISO norm	DIN norm
191643	Pkg. 200	M4x18 mm	7046	965
B191643	Pkg. 2000	M4x18 mm	7046	965
B192569	Pkg. 1000	M4x18 mm	7046	965
190561	Pkg. 200	M4x20 mm	7046	965
191533	Pkg. 200	M4x22 mm	7046	965
B191533	Pkg. 2000	M4x22 mm	7046	965
191322	Pkg. 200	M4x25 mm	7046	965
191323	Pkg. 200	M4x30 mm	7046	965
191678	Pkg. 200	M5x16 mm	7046	965
191435	Pkg. 200	M5x35 mm	7046	965
191763	Pkg. 200	M6x20 mm	7046	965
192347	Pkg. 100	M6x30 mm	7046	965

PAN HEAD









HC-CARGO	Std pkg	Dim.	ISO norm	DIN norm
190531	Pkg. 200	M3x10 mm	7045	7985
192413	Pkg. 200	M3x16 mm	7045	7985
192254	Pkg. 500	M3x20 mm	7045	7985
191266	Pkg. 200	M3x5 mm	7045	7985
190536	Pkg. 200	M4x10 mm	7045	7985
190537	Pkg. 200	M4x12 mm	7045	7985
191317	Pkg. 200	M4x14 mm	7045	7985
190538	Pkg. 200	M4x16 mm	7045	7985
191318	Pkg. 200	M4x18 mm	7045	7985
190539	Pkg. 200	M4x20 mm	7045	7985
192586	Pkg. 200	M4x22 mm	7045	7985
190540	Pkg. 200	M4x25 mm	7045	7985
190541	Pkg. 200	M4x30 mm	7045	7985
190542	Pkg. 200	M4x40 mm	7045	7985
191586	Pkg. 200	M4x6 mm	7045	7985
191770	Pkg. 200	M4x8 mm	7045	7985
190544	Pkg. 500	M5x10 mm	7045	7985
192145	Pkg. 200	M5x12 mm	7045	7985
192065	Pkg. 200	M5x16 mm	7045	7985
192046	Pkg. 200	M5x20 mm	7045	7985
192216	Pkg. 200	M5x25 mm	7045	7985
190549	Pkg. 200	M5x30 mm	7045	7985
192444	Pkg. 100	M5x35 mm	7045	7985
190550	Pkg. 200	M5x40 mm	7045	7985
191762	Pkg. 200	M5x45 mm	7045	7985
190551	Pkg. 200	M5x50 mm	7045	7985
191267	Pkg. 200	M5x60 mm	7045	7985
191319	Pkg. 200	M5x6 mm	7045	7985
191554	Pkg. 200	M5x8 mm	7045	7985
190552	Pkg. 200	M6x10 mm	7045	7985
190556	Pkg. 200	M6x25 mm	7045	7985
190558	Pkg. 200	M6x40 mm	7045	7985

PAN HEAD W/ESLOK



HC-CARGO	Std pkg	Dim.	ISO norm	DIN norm
192569	Pkg. 100	M4x18 mm	7046	965
192571	Pkg. 200	M4x22 mm	7046	965

PAN HEAD W/WASHER					
	HC-CARGO	Std pkg	Dim.		
	191478	Pkg. 100	M4x25 mm		
	B191478	Pkg. 5000	M4x25 mm		
THRU BOLTS					
	HC-CARGO	Std pkg	Dim.	Thread size	
	B230731	Pkg. 100	M5x65.3 mm	21.7 mm	
	191899	Pkg. 20	M5x90 mm	35 mm	
	191528	Pkg. 20	M5x95 mm	30 mm	
	191582	Pkg. 20	M5x100 mm	60 mm	
	B191582	Pkg. 100	M5x100 mm	60 mm	
	191873	Pkg. 20	M5x120 mm	60 mm	
	191584	Pkg. 20	M5x125 mm	60 mm	
	191585	Pkg. 20	M5x138.7 mm	61.2 mm	
	191530	Pkg. 10	M6x79 mm	24.6 mm	
	191531	Pkg. 10	M6x89.4 mm	25.3 mm	
	191558	Pkg. 20	M6x95 mm	30 mm	
TORX					
FLAT HEAD					
192754 Hex Screw		Std pkg 100			
		Length: 12 mm Thread: M8x		Head type: Flat head Screw type: Torx ISO norm: 14581	
SLOTTED					
CHEESE HEAD					
	HC-CARGO	Std pkg	Dim.	ISO norm	DIN norm
	191320	Pkg. 200	M5x8 mm	1207	84A
	190545	Pkg. 200	M5x12 mm	1207	84A
	191505	Pkg. 200	M5x14 mm	1207	84A
	190546	Pkg. 200	M5x16 mm	1207	84A
	190547	Pkg. 200	M5x20 mm	1207	84A
	191557	Pkg. 200	M5x25 mm	1207	84A
	191321	Pkg. 200	M6x12 mm	1207	84A
	190555	Pkg. 200	M6x20 mm	1207	84A
	192515	Pkg. 200	M6x22 mm	1207	84A
CHEESE HEAD, PHILLIPS					
	HC-CARGO	Std pkg	Dim.	Spanner size	ISO norm
	192984	Pkg. 200	M4x30 mm	4.8	7048
	192364	Pkg. 200	M4x35 mm		
FLANGE					
	HC-CARGO	Std pkg	Dim.		
	191658	Pkg. 200	M4x6 mm		
	191677	Pkg. 200	M4x8 mm		
	191661	Pkg. 200	M5x10 mm		
	191660	Pkg. 200	M5x8 mm		

SOCKET HEAD CAPS

FULLY THREADED

	HC-CARGO	Std pkg	Dim.	Quality	ISO norm	DIN norm
	192672	Pkg. 100	M4x10 mm	12.9	4762	912
	191486	Pkg. 100	M5x14 mm	12.9	4762	912
	191613	Pkg. 100	M5x20 mm	12.9	4762	912
	192440	Pkg. 100	M5x25 mm	12.9	4762	912
	192405	Pkg. 100	M5x45 mm	12.9	4762	912
	192591	Pkg. 100	M6x16 mm	12.9	4762	912
	191614	Pkg. 100	M6x20 mm	12.9	4762	912
	192592	Pkg. 100	M6x25 mm	12.9	4762	912
	192594	Pkg. 100	M6x50 mm	12.9	4762	912
	192790	Pkg. 1	M7x50 mm	8.8	4762	912

PARTLY THREADED

	HC-CARGO	Std pkg	Dim.	ISO norm	Quality
	192073	Pkg. 100	M5x55 mm	22 mm	12.9
	192441	Pkg. 100	M5x60 mm	22 mm	12.9
	191539	Pkg. 20	M5x75 mm	25 mm	12.9

THREAD FORMING

PAN HEAD

	HC-CARGO	Std pkg	Thread length	ISO norm	DIN norm
	192727	Pkg. 500	M4x16 mm	T20	7500

NUTS

HEX

STEEL, DIN 934



	HC-CARGO	Std pkg	Dim.	Spanner size	DIN norm
	190520	Pkg. 200	M3	5.5 mm	934
	190521	Pkg. 200	M4	7 mm	934
	190779	Pkg. 200	M5	8 mm	934
	190780	Pkg. 200	M6	10 mm	934
	190781	Pkg. 200	M7	11 mm	934
	190782	Pkg. 200	M8	13 mm	934
	191898	Pkg. 25	M10	14 mm	934
	190783	Pkg. 200	M10	17 mm	934
	191477	Pkg. 200	M12	19 mm	934
	191297	Pkg. 200	M12-1.25	19 mm	934
	191296	Pkg. 200	M12-1.5	19 mm	934
	191298	Pkg. 200	M14-1.5	22 mm	934
	191299	Pkg. 200	M16-1.5	24 mm	934
	192127	Pkg. 200	UNC 1/4"	7/16"	934

STEEL, DIN 439B						
	HC-CARGO	Std pkg	Dim.	Spanner size	ISO norm	DIN norm
	191302	Pkg. 200	M5	8 mm	4035	439B
	191303	Pkg. 500	M6	10 mm	4035	439B
	191304	Pkg. 200	M8	13 mm	4035	439B
	191305	Pkg. 200	M10	17 mm	4035	439B
	191439	Pkg. 200	M12	19 mm	4035	439B
	192228	Pkg. 100	M14-1.5	22 mm	4035	439B
	191657	Pkg. 100	M16-1.5	24 mm	4035	439B

SELF-LOCKING W/NYLON						
	HC-CARGO	Std pkg	Dim.	Spanner size	DIN norm	
	190524	Pkg. 200	M5	8 mm	985-6	
	190525	Pkg. 200	M6	10 mm	985-6	
	190527	Pkg. 200	M8	13 mm	985-6	
	190528	Pkg. 200	M10	17 mm	985-6	
	192143	Pkg. 200	M12	19 mm	985-6	

SELF-LOCKING W/FLANGE						
	HC-CARGO	Std pkg	HC-CARGO	Std pkg	Dim.	Spanner size
	191306	Pkg. 200	B191306	Pkg. 5000	M4	7 mm
	193502	Pkg. 200			M5	
	191307	Pkg. 200	B191307	Pkg. 5000	M5	8 mm
	191308	Pkg. 200	B191308	Pkg. 3000	M6	10 mm
	191513	Pkg. 200	B191513	Pkg. 2000	M8	13 mm

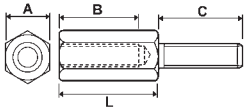
COUPLING						
	HC-CARGO	Std pkg			Dim.	Spanner size
	192417	Pkg. 200			M6	10 mm
	192072	Pkg. 200			M8	13 mm

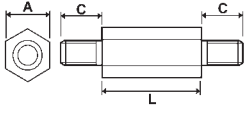
THREADED SPACERS						
191580 Threaded Spacer		Std pkg 100				
				A: 7 mm	Thread type: Inner & Outer Material: Steel	
				B: M4x9 mm		
			C: M4x8 mm			
			L: 12 mm			
			Coating: Electro galvanized			
191625 Threaded Spacer		Std pkg 10				
				A: 8 mm	Thread type: External Material: Steel	
				C: M5x10 mm		
			L: 40 mm			
			Coating: Electro galvanized			

FLAME ARRESTERS

COPPER

	HC-CARGO	Std pkg	ID	OD	Thickness
	080696	Pkg. 10	6.2 mm	9.8 mm	1 mm
	080456	Pkg. 10	6.8 mm	14.5 mm	1 mm
	080689	Pkg. 10	7 mm	11 mm	1.5 mm
	080403	Pkg. 10	7 mm	15 mm	6.7 mm
	081173	Pkg. 10	7/7.7 mm	15 mm	1.5 mm
	080439	Pkg. 10	7.2 mm	20 mm	1.5 mm
	080412	Pkg. 10	7.3 mm	14 mm	4.5 mm
	080410	Pkg. 10	7.3 mm	14 mm	4.8 mm
	080691	Pkg. 10	7.35 mm	14.95 mm	1.5 mm
	080739	Pkg. 10	7.4 mm	13.8 mm	1.55 mm
	081067	Pkg. 5	7.4 mm	14.95 mm	1.76 mm
	081068	Pkg. 10	7.4 mm	14.95 mm	1.96 mm
	080425	Pkg. 10	7.5 mm	15 mm	2 mm
	081209	Pkg. 10	7.5 mm	15 mm	2 mm
	081114	Pkg. 10	7.5 mm	15 mm	3 mm
	080397	Pkg. 20	7.5 mm	20 mm	2.7 mm
	081113	Pkg. 10	7.6 mm	13 mm	2.5 mm
	081212	Pkg. 10	7.6 mm	17 mm	3.5 mm
	081115	Pkg. 10	7.75/7.15 mm	15 mm	1.5 mm
	080417	Pkg. 20	7.8 mm	10.8 mm	1.5 mm
	081055	Pkg. 10	7.8 mm	14.95 mm	1.56 mm
	080426	Pkg. 10	8 mm	15 mm	1 mm
	080427	Pkg. 10	8 mm	15 mm	2 mm
	080803	Pkg. 10	8.3 mm	12.9 mm	2.5 mm
	080454	Pkg. 10	9.5 mm	22.5 mm	0.4 mm
	080692	Pkg. 10	9.75 mm	18.7 mm	2 mm
	080428	Pkg. 10	10 mm	15 mm	2 mm
	080431	Pkg. 10	10 mm	16.3 mm	1.5 mm
	080435	Pkg. 10	10 mm	18 mm	0.5 mm
	080433	Pkg. 10	10 mm	18 mm	1.5 mm
	080432	Pkg. 10	10 mm	18 mm	1 mm
	080438	Pkg. 10	10 mm	19 mm	0.3 mm
	080436	Pkg. 10	10 mm	19 mm	2 mm
	080440	Pkg. 10	10 mm	20 mm	0.5 mm
	080441	Pkg. 10	10 mm	20 mm	1 mm
	080442	Pkg. 10	10 mm	20 mm	1.5 mm
	080296	Pkg. 10	10 mm	20 mm	2 mm
	080443	Pkg. 10	10 mm	20 mm	2 mm
	080452	Pkg. 10	10 mm	22 mm	0.7 mm
	080453	Pkg. 10	10 mm	22 mm	1 mm
	080402	Pkg. 20	11 mm	17.5 mm	5.8 mm
	080434	Pkg. 10	12 mm	18 mm	2 mm
	080705	Pkg. 10	12.3 mm	17.9 mm	1.4 mm
	080446	Pkg. 10	14.3 mm	20 mm	2 mm
	080734	Pkg. 10	14.4 mm	20.8 mm	1.4 mm
	080430	Pkg. 10	14.5 mm	21 mm	1.5 mm
	080688	Pkg. 10	14.5 mm	22.5 mm	1.4 mm
	080444	Pkg. 10	14 mm	20 mm	1.8 mm
	080447	Pkg. 10	14 mm	20 mm	2.5 mm
	080448	Pkg. 10	15.3 mm	20 mm	2 mm
	080802	Pkg. 10	15.6 mm	21.2 mm	2.25 mm
	080763	Pkg. 10	15.7 mm	20.5 mm	2 mm
	080761	Pkg. 10	17 mm	20 mm	1.5 mm
	080777	Pkg. 10	17.1 mm	21.2 mm	1.7 mm
	080450	Pkg. 10	17.5 mm	21.5 mm	1.5 mm



FIBER						
	HC-CARGO	Std pkg	ID	OD	Thickness	
	080031	Pkg. 10	5 mm	9.5 mm	2 mm	
	080033	Pkg. 100	8 mm	15 mm	1.5 mm	
	080035	Pkg. 100	12 mm	18 mm	1.5 mm	
STEEL						
	HC-CARGO	Std pkg	ID	OD	Thickness	
	080404	Pkg. 25	4.9 mm	11.5 mm	1.25 mm	
	080408	Pkg. 25	5.2 mm	13.9 mm	1.1 mm	
	080390	Pkg. 20	5.3 mm	20.3 mm	3.5 mm	
	080407	Pkg. 25	6.4 mm	13.9 mm	1.7 mm	
	080398	Pkg. 20	7.2 mm	13.6 mm	1.3 mm	
	080388	Pkg. 25	7.3 mm	13.6 mm	1.3 mm	
	080423	Pkg. 10	7.6 mm	20.3 mm	2.5 mm	
	080736	Pkg. 20	7.7 mm	20 mm	2.65 mm	
	080449	Pkg. 10	9.3 mm	20.5 mm	2.6 mm	
	080732	Pkg. 20	10 mm	20 mm	2.65 mm	
	ALUMINIUM					
	HC-CARGO	Std pkg	ID	OD	Thickness	
	080437	Pkg. 10	10 mm	19 mm	0.3 mm	
BRASS						
	HC-CARGO	Std pkg	ID	OD	Thickness	
	080236	Pkg. 10	7.1 mm	13.4 mm	1.1 mm	
	080405	Pkg. 25	7.1 mm	13.8 mm	1.3 mm	
	080406	Pkg. 25	8.5 mm	14.3 mm	1.1 mm	
	080419	Pkg. 25	8.8 mm	14 mm	1.3 mm	
	080424	Pkg. 10	10.8 mm	17.5 mm	1.7 mm	
	080418	Pkg. 10	12.6 mm	18 mm	2.5 mm	
WASHERS						
FLAT STEEL						
	HC-CARGO	Std pkg	ID	OD	Thickness	Material
	190587	Pkg. 200	3.5 mm	9.5 mm	0.8 mm	Steel
	190588	Pkg. 200	4.3 mm	9.5 mm	0.8 mm	Steel
	191502	Pkg. 200	5.3 mm	9 mm	1 mm	Steel
	191506	Pkg. 200	5.3 mm	10 mm	1 mm	Steel
	192667	Pkg. 200	5.3 mm	12 mm	1 mm	Steel
	190589	Pkg. 200	5.5 mm	12.7 mm	1 mm	Steel
	192695	Pkg. 200	6.4 mm	25 mm	1.8 mm	Steel
	191290	Pkg. 200	6.5 mm	13 mm	1 mm	Steel
	190590	Pkg. 200	6.8 mm	16 mm	1.1 mm	Steel
	190591	Pkg. 200	7.4 mm	14 mm	1.6 mm	Steel
	190592	Pkg. 200	8.4 mm	18 mm	1.25 mm	Steel
	192696	Pkg. 200	8.4 mm	30 mm	2 mm	Steel
	191337	Pkg. 100	10 mm	16 mm	0.5 mm	Steel
	192362	Pkg. 100	10 mm	16 mm	1 mm	Steel
	190593	Pkg. 100	10 mm	21 mm	1.25 mm	Steel
	192062	Pkg. 200	12 mm	18 mm	0.5 mm	Steel
	191491	Pkg. 100	12 mm	18 mm	1 mm	Steel
	191457	Pkg. 100	13 mm	19 mm	0.5 mm	Steel
	190594	Pkg. 100	13 mm	24 mm	2.5 mm	Steel
	191335	Pkg. 100	14 mm	26 mm	0.5 mm	Steel
	191868	Pkg. 100	15 mm	22 mm	0.1 mm	Steel

	HC-CARGO	Std pkg	ID	OD	Thickness	Material
	191548	Pkg. 100	15 mm	22 mm	0.5 mm	Steel
	191538	Pkg. 100	15 mm	22 mm	1 mm	Steel
	191901	Pkg. 100	17 mm	24 mm	0.5 mm	Steel
	191560	Pkg. 100	17 mm	24 mm	1.5 mm	Steel
	192663	Pkg. 100	17 mm	24 mm	1 mm	Steel
	192821	Pkg. 100	18 mm	31.9 mm	0.5 mm	Metal
	191815	Pkg. 100	20 mm	28 mm	0.5 mm	Steel







SEALING RINGS

	HC-CARGO	Std pkg	ID	OD	Thickness	Material
	190824	Pkg. 100	6.3 mm	12 mm	1 mm	Copper
	190823	Pkg. 100	6 mm	10 mm	1 mm	Copper
	080004	Pkg. 25	6 mm	12 mm	1 mm	Copper
	190826	Pkg. 100	8.2 mm	12 mm	1 mm	Copper
	190828	Pkg. 100	8 mm	14 mm	1 mm	Copper
	190806	Pkg. 100	10.3 mm	16 mm	1 mm	Copper
	190807	Pkg. 100	12 mm	16 mm	1.5 mm	Aluminium
	190808	Pkg. 100	12 mm	16 mm	1.5 mm	Copper
	190809	Pkg. 100	12 mm	18 mm	1.5 mm	Copper
	191358	Pkg. 100	12 mm	24 mm	1 mm	Copper
	190810	Pkg. 100	13 mm	18 mm	1.5 mm	Copper
	190811	Pkg. 100	14 mm	18 mm	1.5 mm	Aluminium
	190812	Pkg. 100	14 mm	18 mm	1.5 mm	Copper
	190813	Pkg. 100	14 mm	20 mm	1.5 mm	Aluminium
	190815	Pkg. 100	14 mm	20 mm	1.5 mm	Copper
	190816	Pkg. 100	16 mm	20 mm	1 mm	Copper
	190817	Pkg. 100	16 mm	20 mm	1.5 mm	Copper
	190818	Pkg. 100	16 mm	22 mm	1.5 mm	Copper
	191489	Pkg. 100	16 mm	24 mm	1.5 mm	Copper
	190819	Pkg. 100	18 mm	22 mm	1.5 mm	Copper
	190820	Pkg. 100	18 mm	24 mm	1.5 mm	Copper
	191490	Pkg. 100	18 mm	26 mm	1.5 mm	Copper
190821	Pkg. 100	20 mm	26 mm	1.5 mm	Copper	
190822	Pkg. 100	22 mm	27 mm	1.5 mm	Copper	

INSULATORS

FIBERS

	HC-CARGO	Std pkg	ID	OD	Thickness	Material
	191346	Pkg. 100	4 mm	13 mm	1 mm	Red fiber
	191351	Pkg. 100	5 mm	12 mm	1 mm	Red fiber
	191352	Pkg. 100	5 mm	16 mm	1 mm	Red fiber
	191344	Pkg. 100	6 mm	10 mm	1 mm	Red fiber
	191350	Pkg. 100	6 mm	18 mm	1.5 mm	Red fiber
	191442	Pkg. 100	7.5 mm	14 mm	3 mm	Red fiber
	191353	Pkg. 100	8 mm	12 mm	0.5 mm	Red fiber
	191345	Pkg. 100	8 mm	20 mm	2 mm	Red fiber
	191349	Pkg. 100	10 mm	16 mm	1 mm	Red fiber
	191648	Pkg. 100	10 mm	25 mm	2 mm	Red fiber
	191348	Pkg. 100	12.2 mm	22 mm	1 mm	Red fiber
	191339	Pkg. 100	12 mm	19 mm	1 mm	Red fiber
	191347	Pkg. 100	13 mm	23 mm	1.5 mm	Red fiber
	191430	Pkg. 100	14.5 mm	29 mm	1 mm	Red fiber
	191532	Pkg. 100	14 mm	34 mm	2 mm	Red fiber
	191869	Pkg. 100	15 mm	24 mm	0.5 mm	Red fiber
	191355	Pkg. 100	20.5 mm	35 mm	1.5 mm	Red fiber
	191354	Pkg. 100	45 mm	51 mm	1 mm	Red fiber

FENDERS								
	HC-CARGO	Std pkg	ID	OD	Thickness	ISO norm	DIN norm	
	191813	Pkg. 1000	3.2 mm	9 mm	0.8 mm	7093	9021A	
	191289	Pkg. 200	4.3 mm	12 mm	1 mm	7093	9021A	
	190603	Pkg. 200	5.3 mm	15 mm	1.2 mm	7093	9021A	
	192694	Pkg. 200	5.3 mm	20 mm	1.5 mm	7093	9021A	
	190604	Pkg. 200	6.4 mm	18 mm	1.6 mm	7093	9021A	
	191291	Pkg. 200	8.4 mm	15 mm	1.6 mm	7092	433	
	190605	Pkg. 200	8.4 mm	24 mm	2 mm	7093	9021A	
SPRING LOCK								
	HC-CARGO	Std pkg	ID	Material				
	192348	Pkg. 200	1/2"	Steel spring				
	192128	Pkg. 200	1/4"	Steel spring				
CURVED								
	HC-CARGO	Std pkg	ID	OD	Thickness	Material		
	190577	Pkg. 200	3.1 mm	6.2 mm	0.7 mm	Steel spring		
	190578	Pkg. 1000	4.11 mm	7.2 mm	0.85 mm	Steel spring		
	192678	Pkg. 200	5.3 mm	10 mm	0.5 mm	Steel spring		
	190579	Pkg. 1000	5.4 mm	9.2 mm	1 mm	Steel spring		
	190580	Pkg. 200	6.1 mm	11.8 mm	1.3 mm	Steel spring		
	190581	Pkg. 500	7.1 mm	12.8 mm	1.3 mm	Steel spring		
	190582	Pkg. 500	8.1 mm	14.8 mm	1.6 mm	Steel spring		
	192679	Pkg. 200	8.4 mm	15 mm	0.5 mm	Steel spring		
	190583	Pkg. 200	10.2 mm	18.1 mm	1.8 mm	Steel spring		
	190584	Pkg. 200	12.2 mm	18.1 mm	2.1 mm	Steel spring		
	191287	Pkg. 200	14.2 mm	24.1 mm	2.4 mm	Steel spring		
	191288	Pkg. 200	16.2 mm	27.4 mm	2.8 mm	Steel spring		
	STEEL							
W/CHAMFER								
	HC-CARGO	Std pkg	ID	OD	Thickness	ISO norm	DIN norm	Material
	190598	Pkg. 200	6.4 mm	12 mm	1.6 mm	7090	125B	Steel
	190599	Pkg. 200	8.4 mm	16 mm	1.6 mm	7090	125B	Steel
	191579	Pkg. 100	10.5 mm	20 mm	2 mm	7090	125B	Steel
W/KEY SLOT								
	HC-CARGO	Std pkg	ID	OD	Thickness	Material		
	191265	Pkg. 100	17 mm	34 mm	2 mm	Steel		
LOCK								
EXTERNAL SERRATED								
	HC-CARGO	Std pkg	ID	DIN norm		Material		
	190616	Pkg. 200	M4	6798A		Steel		
	190612	Pkg. 200	M5	6798A		Steel		
	190613	Pkg. 200	M6	6798A		Steel		
	190614	Pkg. 200	M8	6798A		Steel		

INTERNAL SERRATED

	HC-CARGO	Std pkg	ID	DIN norm	Material
	190608	Pkg. 200	M6	6798J	Steel
	190609	Pkg. 200	M8	6798J	Steel
	190610	Pkg. 200	M10	6798J	Steel

WAVED TYPE

	HC-CARGO	Std pkg	ID	OD	Thickness
	191903	Pkg. 100	11.4 mm	18.8 mm	0.3 mm
	191913	Pkg. 100	16.3 mm	24 mm	1.5 mm
	191336	Pkg. 100	17 mm	30 mm	1.6 mm

COTTER PINS

	HC-CARGO	Std pkg	OD	Length	DIN norm	Material
	191575	Pkg. 100	1.6 mm	16 mm	94	Steel
	190634	Pkg. 100	2.5 mm	25 mm	94	Steel
	190632	Pkg. 100	2 mm	32 mm	94	Steel
	190633	Pkg. 100	2 mm	40 mm	94	Steel
	191576	Pkg. 100	3.2 mm	25 mm	94	Steel
	190638	Pkg. 100	3.2 mm	32 mm	94	Steel
	191577	Pkg. 100	4 mm	36 mm	94	Steel

BUSHINGS

	HC-CARGO	Std pkg	Length	
	080161	Pkg. 1	20 mm	<i>For cover.</i>
	080162	Pkg. 1	25 mm	<i>For cover.</i>
	080165	Pkg. 1	30.5 mm	<i>For cover.</i>
	080232	Pkg. 1	33.5 mm	<i>For cover.</i>
	080164	Pkg. 1	35 mm	<i>For cover.</i>
	080163	Pkg. 1	40.5 mm	<i>For cover.</i>

THREADED

	HC-CARGO	Std pkg	Length	Thread/internal	Thread/external	
	192578	Pkg. 10	10 mm	M10-1	M12-1	<i>For Glow Plugs.</i>

RIVETS

	HC-CARGO	Std pkg	OD	Length	DIN norm	Material
	191285	Pkg. 100	4 mm	12 mm	660	Aluminium
	192048	Pkg. 100	5 mm	20 mm	674	Aluminium

BLIND

	HC-CARGO	Std pkg	OD	Length	Grip range	DIN norm	Material
	193263	Pkg. 1					
	191458	Pkg. 100	4 mm	10 mm	5-6.5	7337A	Alu/Steel
	191459	Pkg. 100	4 mm	16 mm	8.5-12	7337A	Alu/Alu

TUBULAR					
	HC-CARGO	Std pkg	OD	Length	Material
	191552	Pkg. 100	6 mm	25 mm	Brass

STORAGE

200633 Assortment Box Std pkg 1

Metal. w/ plastic insertion. 20 rooms. Dim.: 333x230x55 mm.

					
---	--	--	--	--	--

ASSORTMENTS

BOXES

200663 Assortment Box Std pkg 1

Can be divided using inserts.

		Length: 265 mm Thickness: 57 mm Width: 340 mm	Material: Polypropylene
---	--	---	-------------------------

200875 Carry Lite Assortment Box Std pkg 1

		Length: 413 mm Thickness: 57 mm Width: 330 mm	Colour: Anthracite Material: Polypropylene
---	--	---	---

200876 Carry Lite Assortment Box Std pkg 1

80-01.

		Length: 413 mm Thickness: 79 mm Width: 330 mm	Colour: Anthracite Material: Polypropylene
---	--	---	---

200877 Carry Lite Assortment Box Std pkg 1

		Length: 413 mm Thickness: 147 mm Width: 330 mm	Colour: Anthracite Material: Polypropylene
---	--	--	---

INSERTS
200664 Insert

Std pkg 1

Unbreakable.

 Length: 40 mm
 Thickness: 45 mm
 Width: 55 mm

Material: Polypropylene

200665 Insert

Std pkg 1

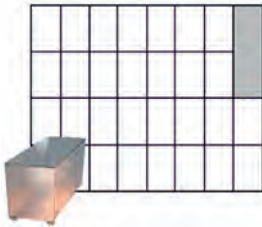
Unbreakable.

 Length: 110 mm
 Thickness: 45 mm
 Width: 40 mm

Material: Polypropylene

200666 Insert

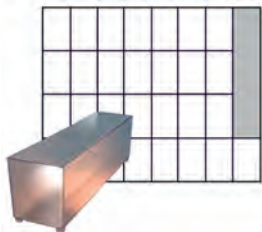
Std pkg 1

Unbreakable.

 Length: 165 mm
 Thickness: 45 mm
 Width: 40 mm

Material: Polypropylene

200667 Insert

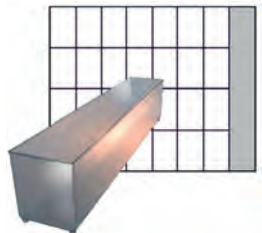
Std pkg 1

Unbreakable.

 Length: 220 mm
 Thickness: 45 mm
 Width: 40 mm

Material: Polypropylene

200668 Insert

Std pkg 1

Unbreakable.

 Length: 80 mm
 Thickness: 45 mm
 Width: 55 mm



Material: Polypropylene

200669 Insert

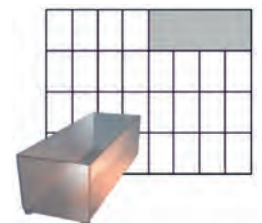
Std pkg 1

Unbreakable.

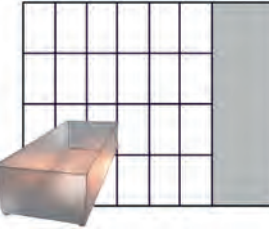
 Length: 160 mm
 Thickness: 45 mm
 Width: 55 mm

Material: Polypropylene

200670 Insert		Std pkg 1		
<i>Unbreakable.</i>				
			Length: 240 mm Thickness: 45 mm Width: 55 mm	Material: Polypropylene
200671 Insert		Std pkg 1		
<i>Unbreakable.</i>				
			Length: 110 mm Thickness: 45 mm Width: 80 mm	Material: Polypropylene
200672 Insert		Std pkg 1		
<i>Unbreakable.</i>				
			Length: 220 mm Thickness: 45 mm Width: 80 mm	Material: Polypropylene
200673 Insert		Std pkg 1		
<i>Unbreakable.</i>				
			Length: 160 mm Thickness: 45 mm Width: 110 mm	Material: Polypropylene
DISPLAY				
200676 Display for 4 Assortments		Std pkg 1		
<i>Frame for 4 Profi service cases.</i>				
			Length: 200 mm Thickness: 330 mm Width: 360 mm	
200693 Assortment Display		Std pkg 1		
<i>Frame for 4 Profi service cases. Can be assembled horizontally or vertically.</i>				
			Length: 265 mm Thickness: 313 mm Width: 373 mm	



Assortments

Edition 2018/2019

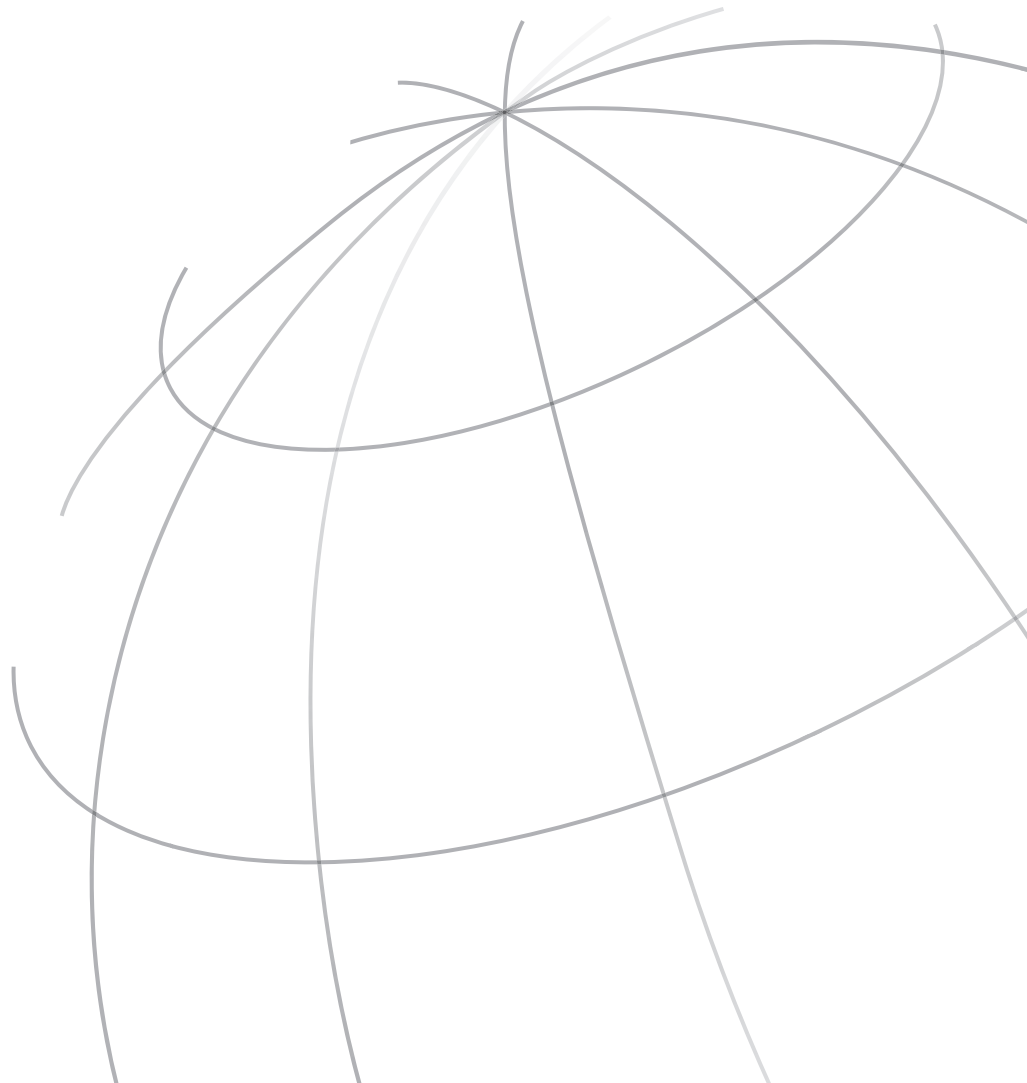

ATO Blade Fuses
804008

Type	Amp	Qty.	Type	Amp	Qty.
191465 ... Mini blade fuse	2	10	190055 ... ATO blade fuse	5	50
191466 ... Mini blade fuse	3	10	190056 ... ATO blade fuse	7.5	50
191467 ... Mini blade fuse	4	10	190057 ... ATO blade fuse	10	50
191468 ... Mini blade fuse	5	10	190058 ... ATO blade fuse	15	50
191469 ... Mini blade fuse	7.5	10	190059 ... ATO blade fuse	20	50
191470 ... Mini blade fuse	10	10	190060 ... ATO blade fuse	25	50
191471 ... Mini blade fuse	15	10	190061 ... ATO blade fuse	30	50
191472 ... Mini blade fuse	20	10	191664 ... ATO blade fuse	40	50
191473 ... Mini blade fuse	25	10			
191474 ... Mini blade fuse	30	10			
191475 ... ATO blade fuse	1	25			
191476 ... ATO blade fuse	2	25			
190053 ... ATO blade fuse	3	50			
190054 ... ATO blade fuse	4	50			

Connectors & Insulators
804012

Type	Pole	Qty.	Type	Pole	Qty.
191007 ... Insulator		50	191225 ... Multiple connector	3-pole	10
191126 ... Insulator		20	190264 ... Multiple connector	4-pole	10
191127 ... Insulator		50	190265 ... Multiple connector	4-pole	10
191227 ... Insulator		10	190266 ... Multiple connector	6-pole	2
191226 ... Insulator		10	190267 ... Multiple connector	6-pole	2
190260 ... Multiple connector	2-pole	10			
190261 ... Multiple connector	2-pole	10			
190843 ... Multiple connector	2-pole	10			
190272 ... Multiple connector	2-pole	10			
191158 ... Multiple connector	2-pole	10			
191159 ... Multiple connector	2-pole	10			
190262 ... Multiple connector	3-pole	10			
190263 ... Multiple connector	3-pole	10			
191224 ... Multiple connector	3-pole	10			

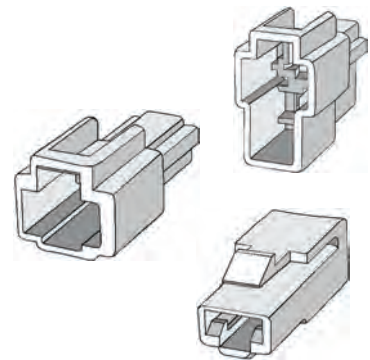
Crimp Terminals - Non-insulated
804013

	Qty.		Qty.
190256 ... Terminal	20	191089 ... Terminal	100
190725 ... Terminal	20	191129 ... Terminal	100
191025 ... Terminal	20	191200 ... Terminal	100
191064 ... Terminal	20	191415 ... Terminal	100
191069 ... Terminal	20	190252 ... Terminal	200
191411 ... Terminal	20	191008 ... Terminal	200
191412 ... Terminal	20		
191413 ... Terminal	20		
190726 ... Terminal	25		
190270 ... Terminal	100		
190868 ... Terminal	100		
191028 ... Terminal	100		
191029 ... Terminal	100		
191083 ... Terminal	100		

Insulated Terminals
804014

	Qty.		Qty.
190049 ... Terminal 2.8 mm, red	100	190023 ... Terminal, OD 4 mm, blue	75
190045 ... Terminal 4.7 mm, red	100	190017 ... Terminal, ID 5 mm, red	100
190022 ... Terminal 6.3 mm, red	100	191009 ... Shrinkable full insulated, red	25
190020 ... Terminal 6.3 mm, blue	100	191010 ... Shrinkable full insulated, blue	25
190024 ... Terminal 6.3 mm, yellow	50	190028 ... Butt connector, red	100
190041 ... Terminal 8.0 mm, blue	50	190001 ... Butt connector, blue	100
190048 ... Terminal 9.5 mm, yellow	50	190018 ... Terminal, blue	50
190985 ... Terminal 6.3 mm, red	100	191011 ... Shrinkable full insul., yellow	20
190046 ... Terminal 6.3 mm, blue	100		
190025 ... Terminal 6.3 mm, red	50		
190026 ... Terminal 6.3 mm, blue	50		
190016 ... Terminal 6.3 mm, blue	100		
190019 ... Terminal 6.3 mm, red	100		
190021 ... Terminal, OD 4 mm, red	100		

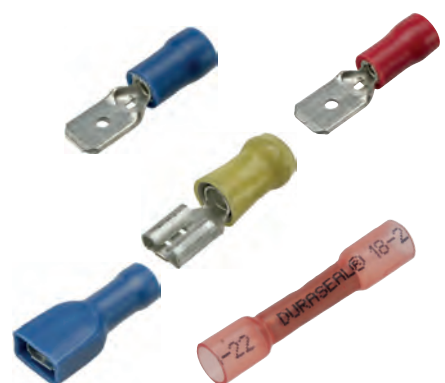

Ring Crimp Terminals - Insulated

804015

	mm	Qty.		mm	Qty.		
190038 ... Terminal	3	red	100	190255 ... Terminal	8	yellow	50
190257 ... Terminal	3	blue	100	190042 ... Terminal	10	yellow	50
190027 ... Terminal	4	red	100	190974 ... Terminal		red	100
190973 ... Terminal	4	red	100	190952 ... Terminal		blue	100
190029 ... Terminal	4	blue	100	190953 ... Terminal		yellow	50
190032 ... Terminal	4	blue	100				
191067 ... Terminal	4	blue	100				
190031 ... Terminal	5	red	100				
190037 ... Terminal	5	blue	100				
190033 ... Terminal	5	yellow	50				
190015 ... Terminal	6	red	100				
190034 ... Terminal	6	blue	100				
190035 ... Terminal	6	yellow	50				
190039 ... Terminal	8	blue	50				

ABS Connectors & Tools

804017

	Qty.
191168 ... Tube for 1.5 mm ²	10
192180 ... Tube for 1.5 mm ²	10
192181 ... Tube for 1.5 mm ²	10
191196 ... Tube for 4.0 mm ²	10
191197 ... Tube for 4.0 mm ²	10
191169 ... Tube for 6.0 mm ²	10
191171 ... Pin for 1.5 mm ²	10
191172 ... Pin for 6.0 mm ²	10
180245 ... Sealing disc kit set	2
210643 ... Ejection tool 6.5 mm ²	1
210639 ... Crimping tool	1
210644 ... Dismounting bush 6.5 mm ²	1
210645 ... Mounting bush 6.5 mm ²	1

Sealing Rings I

804020

ID	OD	Th.	Qty.	ID	OD	Th.	Qty.				
mm	mm	mm		mm	mm	mm					
190823	6	10	1	Copper	20	190813	14	20	1.5	Alu.	20
190824	6	12	1	Copper	20	190815	14	20	1.5	Copper	20
190826	8	12	1	Copper	20	190816	16	20	1	Copper	20
190828	8	14	1	Copper	20	190817	16	20	1.5	Copper	20
080009	10	14	1	Copper	20	190818	16	22	1.5	Copper	20
190806	10	16	1	Copper	20	191489	16	24	1.5	Copper	20
190807	12	16	1.5	Alu.	20	190819	18	22	1.5	Copper	20
190808	12	16	1.5	Copper	20	190820	18	24	1.5	Copper	20
190809	12	18	1.5	Copper	20	191490	18	26	1.5	Copper	20
191358	12	24	1	Copper	20	190821	20	26	1.5	Copper	20
190810	13	18	1.5	Copper	20	190822	22	27	1.5	Copper	20
190811	14	18	1.5	Alu.	20						
190812	14	18	1.5	Copper	20						

Rubber Clamps (Rubber profile 12.7 mm - Fixing hole 6.8 mm)

804021

	Pipe OD	Type	Qty.
190899	6.4 mm	6	10
190900	7.9 mm	8	10
190901	9.5 mm	10	10
190902	11.1 mm	11	10
190903	12.7 mm	13	5
190904	14.3 mm	14	5
190905	15.9 mm	16	5
190906	17.5 mm	18	5
190907	19.0 mm	19	5
190908	22.2 mm	22	5
190909	25.4 mm	25	5
191417	28.6 mm	29	5



Rubber Grommets & Blankings

804022

	B mm	C mm	D mm	Amp	Qty.
190964	5.5		8	1.6	20
190120	6.4		9.5	1.6	20
190965	8		9.5	1.6	20
190966	8		11	1.6	20
190967	8		12.5	1.6	20
190122	9.5		12.5	1.6	20
190968	11		14.2	1.6	20
190969	12.5		17.5	1.6	20
190970	12.5		19	1.6	20
190110	6.4	9.5	9.5	1.6	20
190111	8	10.6	14.2	1.6	20
190112	9.5	12.8	15.4	1.6	20
190114	12.5	15.5	18.7	1.6	20
190115	15.5	19	22	1.6	20

	B mm	C mm	D mm	Amp	Qty.
190116	19	22.1	25.5	1.6	20
190958	22.5	27	28.5	1.6	10
190959	24.4	28.3	32	1.6	10

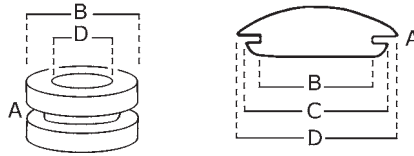

Cable Ties

804024

	L.	W.	Max dia.	Qty.
191003	102	2.50	25 mm	200
191188	150	3.60	39 mm	100
191094	200	2.50	55 mm	200
190248	190	4.80	52 mm	100
191128	92	2.40	16 mm	200
190014	Self adhesive 27 x 27 mm			100



Torpedo & Glass Fuses

804036

	Dim. mm	Amp	Qty.
190285	20 x 5	0.5	20
190286	20 x 5	2	20
190284	20 x 5	6.3	20
190734	20 x 5	10	20
191534	20 x 5	20	20
190276	25 x 6	5	100
190277	25 x 6	8	100
190278	25 x 6	16	100
190279	25 x 6	25	100
190280	25 x 6	40	100
190735	29 x 6.3	10	20
191570	29 x 6.3	15	20
190736	29 x 6.3	25	20
190287	32 x 6.3	5	20

	Dim. mm	Amp	Qty.
190288	32 x 6.3	10	20
190289	32 x 6.3	15	20
190274	32 x 6.3	20	20
190275	32 x 6.3	35	20



Machine Screws & Nuts

804037

	Spanner size mm		Qty.
190520	5.5	M3	200
190521	7	M4	200
190779	8	M5	200
190780	10	M6	200

	Length mm	Qty.
190531	M3 x 10	200
191770	M4 x 8	200
190536	M4 x 10	200
191317	M4 x 14	200
191318	M4 x 18	200
190540	M4 x 25	200
190541	M4 x 30	200
191319	M5 x 6	200
190544	M5 x 10	200
190547	M5 x 20	200
190552	M6 x 10	100



Mini Clamps

804040

	Min mm	Max mm	Ref. no.	Qty.
190005	6	8.3	8	10
190006	7	9.3	9	10
190007	8	10.3	10	10
190008	9	11.3	11	10
190009	9	12.3	12	10
190010	10	13.3	13	10
190937	11	14.3	14	10
190938	12	15.3	15	10

PVC Caps

804041

	OD mm	ID mm	H mm	No.	Qty.
191364	4.8/5.5	3.2/4	5.7	3	100
191365	6/6.7	4.5/5.3	5.9	5	100
191366	6.8/7.4	5/5.6	6.8	6	100
191367	7.6/8.5	6/7.1	8	8	100
191368	8.3/9.4	6.9/7.9	9	10	100
191369	10.1/11	8.2/9.5	9.9	12	50
191370	10.8/12.5	9/10.8	9.6	15	50
191371	11.4/12.8	10.1/11.3	9.8	16	50
191372	13.1/14.5	11.5/13	11.1	18	25
191373	13.9/15.4	12.4/14	12	20	25
191374	14.2/15.7	13/14.7	12.8	25	25
191375	14.9/16.8	14/15.5	12.8	27	50
191480	17.2/18.9	15.8/17.6	14	30	25
191376	18.2/20.2	16.4/18.8	13.9	35	25

Red Crimp Terminals - Insulated

804048

	mm	Qty.		mm	Qty.		
190049	Flat plug	2.8	100	191501	Spade	2	100
190045	Flat plug	4.7	100	190973	Spade	4	100
190022	Flat plug	6.3	100	190974	Pin		100
190025	Flat plug and piggi back	6.3	50				
190985	Flat plug, fully insulated	6.3	100				
190019	Flat tongue	6.3	100				
190021	Round plug, OD 4 mm		100				
190017	Round plug receptacle, ID 4 mm		100				
190028	Butt connector		100				
191009	Butt connector		25				
190038	Ring	3	100				
190027	Ring	4	100				
190031	Ring	5	100				
190015	Ring	6	100				

Blue Crimp Terminals - Insulated

804049

	mm	Qty.		mm	Qty.		
190020	Flat plug	6.3	100	191067	Spade	4	100
190041	Flat plug	8	50	190037	Spade	5	100
190026	Flat plug, fully insulated	4.7	50	190952	Pin		100
190046	Flat plug, fully insulated	6.3	100				
190016	Flat tongue	6.3	100				
190023	Round plug, OD 5 mm		100				
190018	Round plug receptacle, ID 5 mm		50				
190001	Butt connector		100				
191010	Butt connector		25				
190257	Ring	3	100				
190029	Ring	4	100				
190032	Ring	5	100				
190034	Ring	6	100				
190039	Ring	8	100				



Yellow Crimp Terminals - Insulated

804050

	mm	Qty.
190024 . Flat plug.....	6.3	50
190048 . Flat plug.....	9.5	50
191191 . Flat tongue	6.3	50
190051 . Round plug, OD 5 mm ..	50	
190050 . Round plug receptacle, ID 5 mm	50	
190030 . Butt connector	50	
191011 . Butt connector	25	
190033 . Ring	5	50
190035 . Ring	6	50
190255 . Ring	8	50
190042 . Ring	10	50
191515 . Ring	12	100
190953 . Pin.....	100	



Cable Joints

804054

	mm ²	Ring	Qty.
190846 . 4.0 - 6.0	M6	50	
190716	10.0	M6	20
190717	16.0	M6	20
190718	16.0	M8	20
190719	25.0	M8	10
190720	25.0	M10	10
191416	35.0	M8	10
190721	35.0	M10	10
190722	50.0	M8	10
190723	50.0	M10	10



Crimp Seal Terminals

804055

Type	mm	Qty.	Type	mm	Qty.
191009 . Butt connector Red.....	10		191693 . Spade	Red..... 4	10
191010 . Butt connector Blue.....	10		191694 . Spade	Blue..... 4	10
191011 . Butt connector Yellow	10		191695 . Spade	Blue..... 5	10
191682 . Ring	Red..... 4	10	191696 . Spade	Yellow 5	10
191685 . Ring	Blue..... 4	10	191697 . Flat plug, ful.insul. Red.....	6.3	10
191689 . Ring	Yellow 5	10	191698 . Flat plug, ful.insul. Blue.....	6.3	10
191683 . Ring	Red..... 5	10	191699 . Flat tongue.....	Red..... 6.3	10
191686 . Ring	Blue..... 5	10	191700 . Flat tongue.....	Blue..... 6.3	10
191684 . Ring	Red..... 6	10			
191687 . Ring	Blue..... 6	10			
191690 . Ring	Yellow 6	10			
191688 . Ring	Blue..... 8	10			
191691 . Ring	Yellow 8	10			
191692 . Ring	Yellow ... 10	10			



Protection Caps

804065

	H. mm	Qty.
191862 M8-1	10	100
191863 M10-1	10	100
191864 M12-1	12	100
191865 M12-1.5.....	12	100
191866 M14-1.5.....	12	100



Lock Washer

804068

ID	Qty.
191277 M3.2	100
191278 M6	100
191573 M7	100
191279 M8	100
191280 M9	100
191270 M15	100
191271 M18	100
191333 M19	100
191272 M20	100
191273 M21	100
191274 M22	100
191481 M23	100
191275 M24	100
191276 M25	100
191433 M27	100

Tapping Screws I

804069

Dim. mm	Type no.	Qty.
191753 2.9 x 16	4	200
191798 2.9 x 19	4	200
190360 3.5 x 9.5	6	250
190361 3.5 x 16	6	200
190362 3.5 x 19	6	200
190366 4.2 x 9.5	8	200
190367 4.2 x 16	8	200
190368 4.2 x 19	8	200
190371 4.2 x 25	8	200
190372 4.8 x 13	10	200
190373 4.8 x 19	10	200

Cable Clips

804070

Pipe OD	Type	Qty.
191950 3.2 mm	9.5	100
191951 4.8 mm	10.5	100
191952 6.4 mm	12.0	50
191953 7.9 mm	12.0	50
191954 9.5 mm	12.5	50
191955 ... 12.7 mm	15.2	20
191956 ... 15.8 mm	18.2	20
191957 ... 19.4 mm	18.2	20
191958 ... 25.4 mm	22.0	20
191959 ... 31.8 mm	26.2	20

Butt Splices

804073

mm ²	Qty.
192007 1.3	100
192008 2.0	100
191885 6.0	10
191886 10.0	10
191887 16.0	10
191888 25.0	10
191889 35.0	10
191890 50.0	10
191891 70.0	10



Super Seal Connectors

804075

	Qty.		Qty.
192587 .. Single wire seal		192085 .. Superseal... 5 pole Female ...5	
Insulation dia.: 1.8-2.4 mm	100	192086 .. Superseal... 5 pole Male.....5	
192091 .. Single wire seal		192087 .. Superseal... 6 pole Female ...5	
Insulation dia.: 2.6-3.3 mm	100	192088 .. Superseal... 6 pole Male.....5	
192089 .. Male. 1.5 mm 1-1.5 mm ²	100		
192090 .. Female. 1.5 mm 1-1.5 mm ²	100		
192077 .. Superseal... 1 pole Male.....5			
192078 .. Superseal... 1 pole Female ...5			
192079 .. Superseal... 2 pole Female ...5			
192080 .. Superseal... 2 pole Male.....5			
192081 .. Superseal... 3 pole Female ...5			
192082 .. Superseal... 3 pole Male.....5			
192083 .. Superseal... 4 pole Female ...5			
192084 .. Superseal... 4 pole Male.....5			

PAL Fuses II (Slow Blow Fuses)

804076

Type	Amp	Qty.	Type	Amp	Qty.	Type	Amp	Qty.
191153 ... Green	40	1	191975 ... Brown	70	1	191637 ... Brown	70	1
191154 ... Yellow	60	1	191157 ... Black	80	1	191976 ... Black	80	1
191970 ... Red	50	1	191971 ... Darkblue	100	1	191978 ... Darkblue	100	1
191830 ... Brown	25	1	191628 ... Pink	30	1			
191831 ... Green	30	1	191629 ... Green	40	1			
191832 ... Red	45	1	191630 ... Red	50	1			
191833 ... Black	65	1	191631 ... Yellow	60	1			
191834 ... Grey	75	1	191632 ... Brown	70	1			
191672 ... Pink	30	1	191972 ... Black	80	1			
191673 ... Green	40	1	191977 ... Darkblue	100	1			
191155 ... Pink	30	1	191633 ... Pink	30	1			
191973 ... Green	40	1	191634 ... Green	40	1			
191974 ... Red	50	1	191635 ... Red	50	1			
191156 ... Yellow	60	1	191636 ... Yellow	60	1			

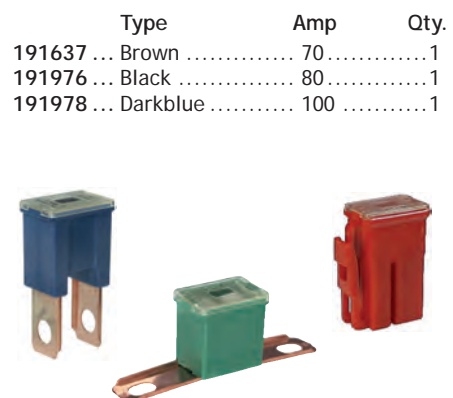
Heat Shrink Pipes I

804077

	mm before crimp	mm after crimp	Qty. m
193170	2.4	1.2	10
193171	3.2	1.6	10
193172	4.8	2.4	8
193173	6.4	3.2	6
193174	9.5	4.8	5
193175	12.7	6.4	5
193176	19.1	9.5	4
193177	25.4	12.7	3

06219..... Display stand 1

 Shrinking temp. 90 °C.
Shrink ration 2:1.

Single Core Cables

804078

	Dim. mm	Length
190697 ... Black	1 x 1.5	100 m
190698 ... Red	1 x 1.5	100 m
190699 ... Blue	1 x 1.5	100 m
190700 ... Yellow	1 x 1.5	100 m
190702 ... Green	1 x 1.5	100 m

06219..... Display stand 1

 1 x 1.5 mm² 30 / 0.250 mm 16 Amp.

Junior-Timer/Junior-Power-Timer II

804081

	Qty.
192177 ... Single wire seal for 0.5-1.0 mm ² cable	100
192178 ... Single wire seal for 1.5-2.5 mm ² cable	100
192156 ... Male 2.8 mm 0.5 - 1.0 mm ²	100
192175 ... Female terminal 0.5-1.0 mm ²	100
192157 ... Male 2.8 mm 1.5 - 2.5 mm ²	100
192176 ... Female terminal 1.0-2.5 mm ²	100
192167 ... 2-pole male holder, black	2
192147 ... 2-pole female holder, black	3
192150 ... Rubber boot for 2-pole. L. 57 mm.	2
192152 ... Rubber boot for 2-pole. Angled	4
192148 ... 3-pole female holder, black	2
192171 ... 4-pole female holder, black	1

	Qty.
192153 ... Rubber boot for 3-pole. L. 57 mm	2
192172 ... 5-pole female holder, black	2
192173 ... 6-pole female holder, black	1

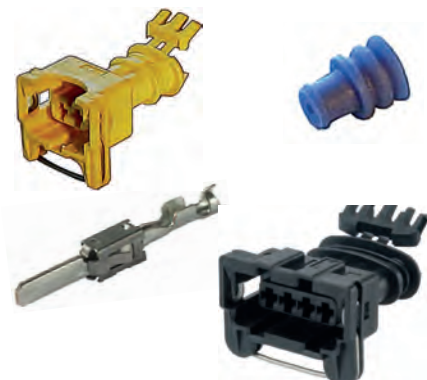
Cord End Terminals

804085

	mm ²	L. mm	Qty.
191962	0.5	10	100
191963	0.75	10	100
191964	1	10	100
191965	1.5	10	100
191966	2.5	10	100
191967	4	12	100
191968	6	15	100
191969	10	15	100
192047	16	18	100

Mega Blade Fuses

804086

	Type	Amp	Qty.
192791	White	40	3
192792	White	60	3
192793	Red	80	3
192049	Yellow	100	3
192050	Green	125	3
192051	Tan	150	3
192052	White	175	3
192053	Blue	200	3
192229	Brown	225	3
192230	Pink	250	3
192231	Grey	300	3
192055	Fuse holder (Terminals: M8)		2

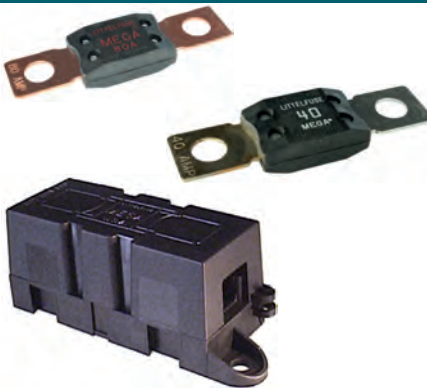
Batteries

804088

	Qty.
200772 ... Lithium Button Battery	5
200773 ... Lithium Button Battery	5
200774 ... Lithium Button Battery	5
200775 ... Lithium Button Battery	5
200802 ... Lithium Button Battery	5
200813 ... Lithium Button Battery	5
200854 ... Lithium Button Battery	5
200858 ... Lithium Button Battery	5
200779 ... Silver Oxide Button Battery	5
200778 ... Alkaline Button Battery	5
200792 ... Alkaline Button Battery	5
200601 ... Alkaline Battery	5
200776 ... Alkaline Battery	5
200777 ... Alkaline Battery	5
200791 ... Alkaline Battery	5



Battery Terminals II
804089

	Qty.
190012 ... Battery Terminal +	5
190013 ... Battery Terminal -	5
190202 ... Battery Terminal +	5
190203 ... Battery Terminal -	5
190213 ... Battery Terminal +	5
190214 ... Battery Terminal -	5
190866 ... Battery Terminal +	5
190867 ... Battery Terminal -	5

Strip Fuses
804090

	Qty.
192305 ... Fuse, 35 Amp	5
192306 ... Fuse, 50 Amp	5
192307 ... Fuse, 80 Amp	5
192308 ... Fuse, 100 Amp	5
192309 ... Fuse, 125 Amp	5
192310 ... Fuse, 160 Amp	5
192311 ... Fuse, 200 Amp	5
192312 ... Fuse, 250 Amp	5
192313 ... Fuse, 300 Amp	5
192314 ... Fuse, 355 Amp	5
192315 ... Fuse, 425 Amp	5
192316 ... Fuse, 500 Amp	5
192344 ... Fuse holder	2

PG Cable Glands
804091

Type	Qty.
192355 Mountinghole 12.1 mm	PG7 . 20
192356 Mountinghole 14.3 mm	PG9 . 15
192357 Mountinghole 18.23 mm	PG11 . 10
192358 Mountinghole 19.9 mm	PG13.5 . 8
192359 Mountinghole 22.1 mm	PG16 . 10
192360 Mountinghole 27.5 mm	PG21 . 10

Pin Terminals - Non-insulated I
804092

	Dia.	mm ²	Qty.
191915 ...	1.0	0.3-0.9	50
191916 ...	1.0	0.3-0.9	50
191985 ...	1.6	0.75-1.5	50
191543 ...	1.6	1.0-2.5	50
191544 ...	1.6	1.0-2.5	50
191074 ...	2.1	1.0-2.5	50
191075 ...	2.1	1.0-2.5	50
191091 ...	2.1	0.5-2.1	50
191092 ...	2.1	0.5-2.1	50
191563 ...	3.5	0.5-2.0	50
191564 ...	3.5	0.5-2.0	50
191078		0.5-2.5	50
191079		0.5-2.5	50



Insulated Terminals w/ Tool
804093

	Qty.		Qty.
190001 ... Butt connector	10	190032 ... 5.0 mm ring	10
190016 ... 6.3 mm flat tongue	10	190035 ... 6.0 mm ring	5
190017 ... ID 4.0 mm round plug receptacle	10	190037 ... 5.0 mm spade	10
190019 ... 6.3 mm flat tongue	10	190042 ... 10.0 mm ring	5
190020 ... 6.3 mm flat plug	10	190046 ... 6.3 mm flat plug, fully insulated	10
190021 ... OD 4.0 mm round plug	10	190050 ... ID 5.0 mm round plug receptacle	5
190022 ... 6.3 mm flat plug	10	190051 ... OD 5.0 mm round plug	5
190024 ... 6.3 mm flat plug	5	190952 ... Pin	10
190026 ... 6.3 mm flat plug and piggyback	10	190953 ... Pin	5
190028 ... Butt connector	10	190973 ... 4.0 mm spade	10
190030 ... Butt connector	5		
190031 ... 5.0 mm ring	10		

	Qty.
190985 ... 6.3 mm flat plug, fully insulated	10
192142 ... 6.0 mm spade	5
210121 ... Crimping tool	1

Midi Blade Fuses
804094

Type	Amp	Qty.
192427 ... Pink	30	3
192428 ... Green	40	3
192429 ... Red	50	3
192430 ... Yellow	60	3
192431 ... Brown	70	3
192432 ... White	80	3
192433 ... Blue	100	3
192434 ... Tan	125	3
192435 ... White	150	3
192436 ... Fuse holder		2

Insulated Crimp Terminals
804095

	Qty.		Qty.
190022 ... Terminal 6.3 mm ... red	100	190255 ... Ring	8 mm ... 50
190020 ... Terminal 6.3 mm ... blue	100	190034 ... Ring	6 mm ... 100
190048 ... Terminal 9.5 mm ... yellow	50		
190985 ... Terminal 6.3 mm ... red	100		
190046 ... Terminal 6.3 mm ... blue	100		
190026 ... Terminal 6.3 mm ... blue	100		
190016 ... Terminal 6.3 mm ... blue	100		
190019 ... Terminal 6.3 mm ... red	100		
190021 ... Terminal, OD 4 mm ... red	100		
190023 ... Terminal, OD 4 mm ... blue	100		
190017 ... Terminal, ID 5 mm ... red	100		
190028 ... Butt connector	red ... 100		
190001 ... Butt connector	blue ... 100		
190018 ... Terminal	blue ... 100		



Mini Blade Fuses
804096

Amp	Qty.
191465 ... 2 ... Grey	10
191466 ... 3 ... Violet	10
191467 ... 4 ... Pink	10
191468 ... 5 ... Tan	10
191469 ... 7.5 ... Brown	10
191470 ... 10 ... Red	10
191471 ... 15 ... Blue	10
191472 ... 20 ... Yellow	10
191473 ... 25 ... Natural	10
191474 ... 30 ... Green	10
210841 ... Extractor	1

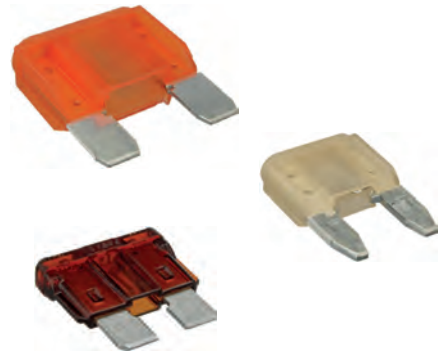

ATO/Mini/Maxi Fuses
804097

	Qty.		Qty.
190055 ... 5 Amp. Tan, ATO.....	20	191250 ... 30 Amp. Green, Maxi.....	3
190056 ... 7.5 Amp. Brown, ATO.....	20	191251 ... 40 Amp. Orange, Maxi.....	3
190057 ... 10 Amp. Red, ATO.....	20	191252 ... 50 Amp. Red, Maxi.....	2
190058 ... 15 Amp. Blue, ATO.....	20	191253 ... 60 Amp. Blue, Maxi.....	2
190059 ... 20 Amp. Yellow, ATO.....	20		
190060 ... 25 Amp. Natural, ATO.....	20		
190061 ... 30 Amp. Green, ATO.....	20		
191468 ... 5 Amp. Tan, Mini.....	15		
191469 ... 7 Amp. Brown, Mini.....	15		
191470 ... 10 Amp. Red, Mini.....	15		
191471 ... 15 Amp. Blue, Mini.....	15		
191472 ... 20 Amp. Yellow, Mini.....	15		
191473 ... 25 Amp. Natural, Mini.....	15		
191474 ... 30 Amp. Green, Mini.....	15		

ATO/Mini/PAL Fuses
804098

	Qty.		Qty.
190056 ... 7.5 Amp. Brown, ATO.....	20	191152 ... 30 Amp. Pink, PAL.....	20
190057 ... 10 Amp. Red, ATO.....	20	191153 ... 40 Amp. Green, PAL.....	1
190058 ... 15 Amp. Blue, ATO.....	20	191970 ... 50 Amp. Red, PAL.....	1
190059 ... 20 Amp. Yellow, ATO.....	20	191830 ... 25 Amp. Brown, PAL.....	1
190061 ... 30 Amp. Green, ATO.....	20	191831 ... 30 Amp. Green, PAL.....	1
191469 ... 7 Amp. Brown, Mini.....	15		
191470 ... 10 Amp. Red, Mini.....	15		
191471 ... 15 Amp. Blue, Mini.....	15		
191472 ... 20 Amp. Yellow, Mini.....	15		
191474 ... 30 Amp. Green, Mini.....	15		
191628 ... 30 Amp. Pink, PAL.....	1		
191629 ... 40 Amp. Green, PAL.....	1		
191630 ... 50 Amp. Red, PAL.....	1		

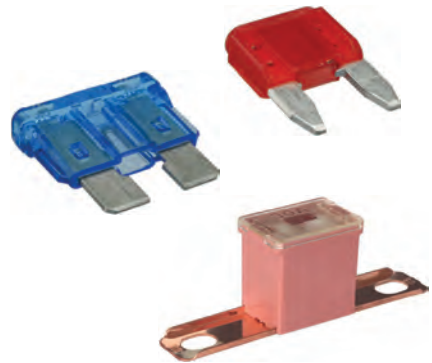
DT Connectors
804100

	Qty.		Qty.
192457 ... 2-pole, female holder.....	3	192469 ... 3-pole, Secondary lock part.....	3
192458 ... 2-pole, male holder.....	3	192470 ... 3-pole, Secondary lock part.....	3
192459 ... 3-pole, female holder.....	3	192471 ... 4-pole, Secondary lock part.....	3
192460 ... 3-pole, male holder.....	3	192472 ... 4-pole, Secondary lock part.....	3
192461 ... 4-pole, female holder.....	3	192473 ... 6-pole, Secondary lock part.....	3
192462 ... 4-pole, male holder.....	3	192474 ... 6-pole, Secondary lock part.....	3
192463 ... 6-pole, female holder.....	3	192475 ... 8-pole, Secondary lock part.....	3
192464 ... 6-pole, male holder.....	3	192476 ... 8-pole, Secondary lock part.....	3
192465 ... 8-pole, female holder.....	3	192452 ... 12-pole, Secondary lock part.....	3
192466 ... 8-pole, male holder.....	3	192453 ... 12-pole, Secondary lock part.....	3
192450 ... 12-pole, female holder.....	3	192477 ... Pin terminal.....	50
192451 ... 12-pole, male holder.....	3	192478 ... Socket terminal.....	50
192467 ... 2-pole, Sekundary lock part.....	3		
192468 ... 2-pole, Sekundary lock part.....	3		

Heat Shrink Pipes II
804101

	mm before crimp	mm after crimp	Qty. mtr.
193197	3	1	5
193198	6	2	3.5
193199	9	3	3
193200	12	4	2.5
193201	18	6	2
193202	24	8	1.5
06219.....	Display stand		1

 Shrinking temp. 100 °C
 Shrink ration 3:1.

Strip Fuses - Closed Type

804102

		Qty.
192325	35 Amp	5
192326	50 Amp	5
192327	80 Amp	5
192328	100 Amp	5
192329	125 Amp	5
192330	160 Amp	5
192331	200 Amp	5
192332	250 Amp	5
192333	275 Amp	5
192334	300 Amp	5
192335	355 Amp	5
192336	425 Amp	5
192337	500 Amp	5
192344	Fuse holder	2

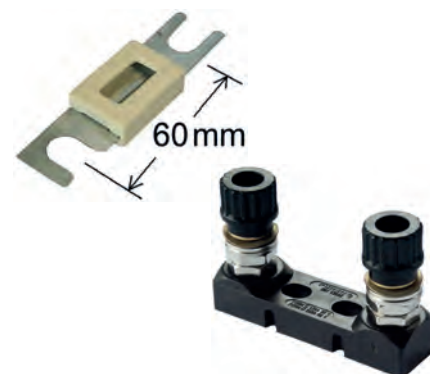

Pin Terminals - Non-insulated II

804103

	mm	mm ²	Qty.		mm	mm ²	Qty.
192174	0.4x1.5	0.35	50	191551	4	0.5x1.5	50
192089	1.5	1x1.5	50	192175	4.3	0.5x1	50
192090	1.5	1x1.5	50	192155	4.5	1.5x2.5	50
192410	1.8	0.5x1.25	50	191129	4.7	0.5x1.5	50
192217	2.7	0.5x1	50	191089	4.8	0.5x1	50
192239	2.8	0.5-1.5	50	192156	5	0.5x1	50
191083	2.8	0.5x1	50	192157	5	1.5x2.5	50
191681	2.8	0.5x1	50	192176	6	1x2.5	50
192411	2.8	0.5x1.25	50				
192240	2.8	0.5x1.5	50				
192373	2.8	0.5x1.5	50				
192374	2.8	0.5x1.5	50				
191806	3	1x3	50				
191807	3	1x3	50				
192140	3.3	0.5x1	50				



Maxi Blade Fuses II

804106

		Qty.
191249	20 Amp	10
191250	30 Amp	10
191251	40 Amp	10
191252	50 Amp	10
191253	60 Amp	10
191254	70 Amp	10
191255	80 Amp	10
191256	100 Amp	10
210842	Extractor	1
191775	Holder kit set	2



DTM Connectors

804107

		Qty.			Qty.
192619	Male type	50	192602	6-pole male holder	3
192620	Female type	50	192601	6-pole female holder	3
192596	2-pole male holder	3	192614	For 6-pole male holder	3
192595	2-pole female holder	3	192613	For 6-pole female holder	3
192608	For 2-pole male holder	3	192604	8-pole male holder	3
192607	For 2-pole female holder	3	192603	8-pole female holder	3
192598	3-pole male holder	3	192616	For 8-pole male holder	3
192597	3-pole female holder	3	192615	For 8-pole female holder	3
192610	For 3-pole male holder	3	192606	12-pole male holder	3
192609	For 3-pole female holder	3	192605	12-pole female holder	3
192600	4-pole male holder	3	192618	For 12-pole male holder	3
192599	4-pole female holder	3	192617	For 12-pole female holder	3
192612	For 4-pole male holder	3			
192611	For 4-pole female holder	3			



Cable Lugs

804110

	mm ²	Ring	Qty.		mm ²	Ring	Qty.
192906	4-6	M8	10	192924	35-50	M10	10
192908	6-10	M6	10	192925	35-50	M12	10
192909	6-10	M8	10	192926	50-70	M8	8
192910	6-10	M10	10	192927	50-70	M10	8
192911	10-16	M6	10				
192912	10-16	M8	10				
192913	10-16	M10	10				
192915	16-25	M6	10				
192916	16-25	M8	10				
192917	16-25	M10	10				
192920	25-35	M8	10				
192921	25-35	M10	10				
192922	35-35	M12	10				
192923	35-50	M8	10				



Thin Wall Cables

804113

193012	1x0.35 mm ²	Black
193013	1x0.35 mm ²	Red
193014	1x0.5 mm ²	Black
193015	1x0.5 mm ²	Red



Fuses - Micro / Mini Low Profile / PAL - Assortment

804117

	Qty.		Qty.
193213 ... 5 Amp. Tan, Micro	10	192769 ... 20 Amp. Yellow, Mini	10
193214 ... 7.5 Amp. Brown, Micro	10	192770 ... 25 Amp. Natural, Mini	10
193215 ... 10 Amp. Red, Micro	10	192771 ... 30 Amp. Green, Mini	10
193216 ... 15 Amp. Blue, Micro	10	192779 ... 20 Amp. Blue, PAL	2
193217 ... 20 Amp. Yellow, Micro	10	192780 ... 25 Amp. White, PAL	2
193218 ... 25 Amp. Natural, Micro	10	192781 ... 30 Amp. Pink, PAL	2
193219 ... 30 Amp. Green, Micro	10	192782 ... 40 Amp. Green, PAL	2
192762 ... 2 Amp. Grey, Mini	10	192783 ... 50 Amp. Red, PAL	2
192763 ... 3 Amp. Violet, Mini	10	192784 ... 60 Amp. Yellow, PAL	2
192764 ... 4 Amp. Pink, Mini	10		
192765 ... 5 Amp. Tan, Mini	10		
192766 ... 7.5 Amp. Brown, Mini	10		
192767 ... 10 Amp. Red, Mini	10		
192768 ... 15 Amp. Blue, Mini	10		



Hose Nipples

807002

	Hose ID	Qty.
070067 ... R 1/4"	10.0 mm	3
080855 ... R 1/2"	10.0 mm	3
070077 ... 1/8-27 NPTF	6.0 mm	3
080955 ... 1/8-27 NPFT	8.0 mm	3
080857 ... 1/2" -20 UNF	8.0 mm	3
080960 ... 1/2" -20 UNF	10.0 mm	3
080954 ... M14-1.5	6.0 mm	3
080854 ... M14-1.5	8.0 mm	3
080959 ... M14-1.5	10.0 mm	3
080858 ... M16-1.5	8.0 mm	3
070070 ... M16-1.5	10.0 mm	3
080958 ... M18-1.5	10.0 mm	3



Toggle Switches

808014

	Qty.
180584 ... Toggle switch, 2 terminals	2
180585 ... Toggle switch, 3 terminals	2
180586 ... Toggle switch, 3 terminals	2
180587 ... Toggle switch, 3 terminals	2
180588 ... Toggle switch, 3 terminals	2
180589 ... Toggle switch, 3 terminals	2
180590 ... Toggle switch, 4 terminals	2
180591 ... Toggle switch, 6 terminals	2
180592 ... Toggle switch, 6 terminals	2
180593 ... Toggle switch, 6 terminals	2
180594 ... Toggle switch, 6 terminals	2
180595 ... Rubber cap	5
181672 ... Rubber cap	5

Mini Rocker Switches

808015

	Qty.
180597 ... 2 terminals, On/Off,	10
180598 ... 3 terminals, On/Off, amber ...	10
180599 ... 3 terminals, On/Off, red	10
180600 ... 3 terminals, On/On	10
180601 ... 3 terminals, On/Off, red spot diode	10
180628 ... 3 terminals, On/Off, green ...	10
180627 ... 3 terminals, On/Off, blue	10

Mini Relays 12 V

811001

	Qty.
160080 ... 30 Amp 4 terminals	6
160081 ... 20/30 Amp 4 terminals	6
160083 ... 30 Amp 4 terminals	2
160155 ... 15 Amp 4 terminals	2
160168 ... 2 x 15 Amp 5 terminals	2
160239 ... 70 Amp 4 terminals	2
160265 ... 30 Amp 5 terminals	2
160270 ... 20/30 Amp 5 terminals	2
160282 ... 40 Amp 4 terminals	6
160308 ... 20/30 Amp 5 terminals	6
160403 ... 15/40 Amp 5 terminals	2
160468 ... 70 Amp 4 terminals	2

Micro Relays

811004

	Qty.
160363 .. 25 Amp 4 terminals	2
160364 .. Normally open w/ diode	2
160365 .. Change over 12 V. 10/20 Amp. ...	2
160366 .. Change over w/ diode	2
160367 .. Change over w/ resistor	2
160368 .. Change over 24 V. 4/10 Amp. ...	2
160521 .. 5/10 Amp. 5 terminals	2
191089 .. Terminal 4.7 mm 0.5-1.0 mm ² ..	100
190868 .. Terminal 6.3 mm 0.5-1.0 mm ² ..	100
190252 .. Terminal 6.3 mm 1.0-2.5 mm ² ..	100
191752 .. Relay multi plug	10



HSS Drills

210574

	OD	Qty.		OD	Qty.
210141 ... HSS Drill.....	1 mm	10	210154 ... HSS Drill.....	7.5 mm	3
210142 ... HSS Drill.....	1.5 mm	10	210155 ... HSS Drill.....	8 mm	5
210143 ... HSS Drill.....	2 mm	10	210156 ... HSS Drill.....	8.5 mm	3
210144 ... HSS Drill.....	2.5 mm	10	210157 ... HSS Drill.....	9 mm	3
210145 ... HSS Drill.....	3 mm	20	210158 ... HSS Drill.....	9.5 mm	3
210146 ... HSS Drill.....	3.3 mm	10	210159 ... HSS Drill.....	10 mm	3
210164 ... HSS Drill.....	3.5 mm	10	210160 ... HSS Drill.....	10.5 mm	3
210147 ... HSS Drill.....	4 mm	10			
210148 ... HSS Drill.....	4.5 mm	10			
210149 ... HSS Drill.....	5 mm	10			
210150 ... HSS Drill.....	5.5 mm	10			
210151 ... HSS Drill.....	6 mm	10			
210152 ... HSS Drill.....	6.5 mm	10			
210153 ... HSS Drill.....	7 mm	5			





Cross Reference List

OE No. - HC-CARGO No.

Edition 2018/2019

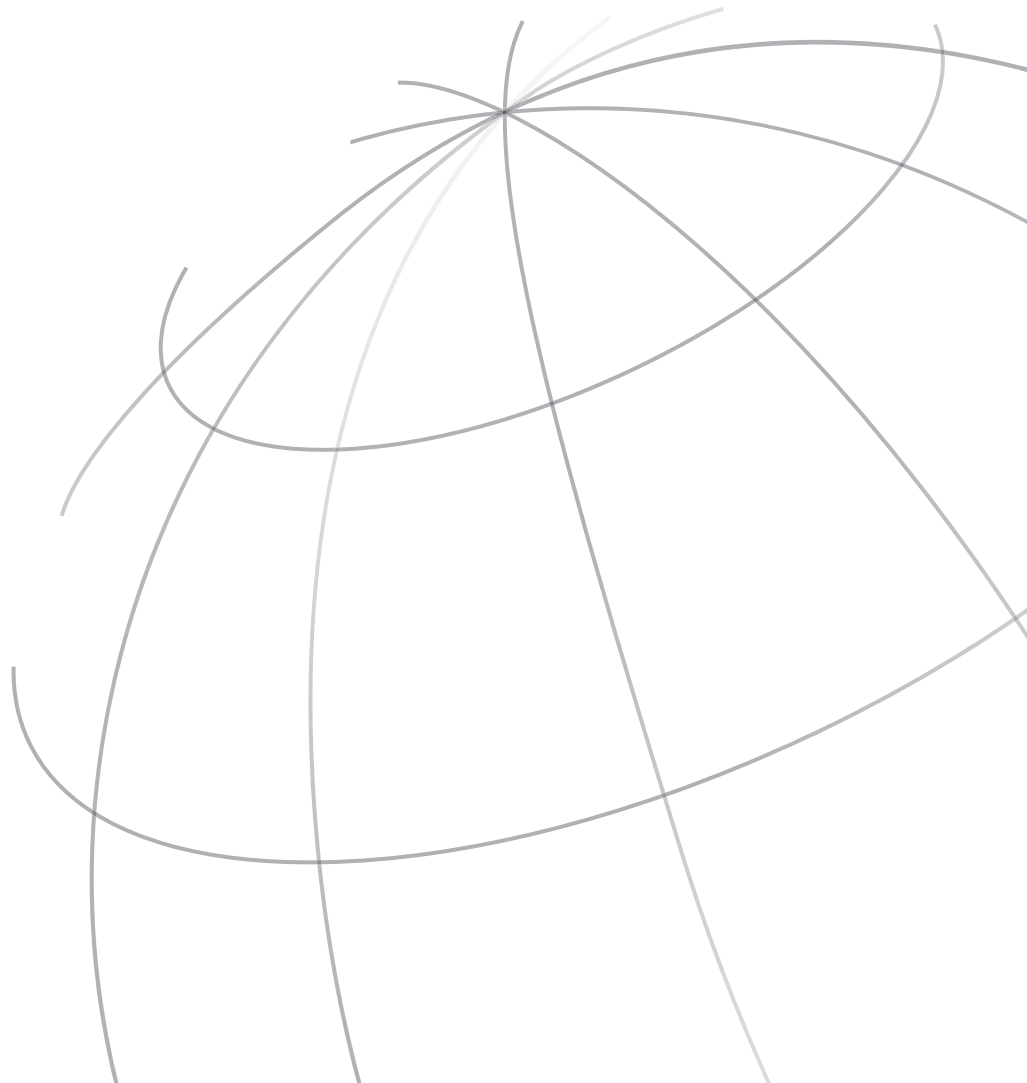

OE No.	HC-CARGO	OE No.	HC-CARGO	OE No.	HC-CARGO	OE No.	HC-CARGO
AGRI		60593846	180634	8953004243	181584	0100220206	100086
029850	080390	60593847	150809	8983501087	150063	0100221101	100263
181902985	080390	60595694	180634	JO854136	181584	0100221102	100511
60079	100511	60596245	100511	TO708955	181584	0100221103	100511
		60623365	150527	TO729963	181584	0100221105	100512
		60623365	150913			0100221106	100511
ALBA		60701852	180726	ARIC		0100221107	100511
2761	171025	60750065	150055	33101000	171140	0100221108	100303
2762	171025	60800167	180875	33140000	171141	0100221112	100511
		60805420	150246	33634000	171147	0100221114	100511
ALFA ROMEO		60805536	150809	33635000	171148	0100221118	100511
105640406001	AS301	60807244	150759	33673000	171153	0100221128	100511
113101101600	181585	60807244	150805	33909130	170635	0100221132	100303
113540402100	070054	60807764	150809	33909132	170636	0100221133	100511
116006513500	160265	60808223	181021	42632000	171299	0100221135	100511
116006513503	160265	60808371	150759	42931000	171299	0100221141	100284
116110402100	070053	60808371	150805	42931536	171307	0100221144	100303
116460102100	070054	60808371	150805	42934000	171302	0100221145	100303
116460402100	070054	60809492	150246	42935000	171303	0100221146	100303
116760403090/65	080696	60809606	150252	42936000	171303	0100221147	100246
116851101600	181584	608114715	181395	42937000	171306	0100221148	100256
116851101600/00	181584	60813321	150759	42937000	171306	0100221151	100260
116851104300	160352	60813321	150805	42938000	171306	0100221154	100261
116976507901	150055	60813687	180804	42939000	171308	0100221162	100331
119110402100	070053	60814769	150451	42939536	171312	0100221163	100511
119111101600	181584	60816553	150451	42940000	171308	0100221167	100511
161241101601	181585	705786	150055	42940536	171312	0100221168	100302
162281101600	181585	7705830	150759	42941000	171311	0100221186	100245
164761113500	160354	7705830	150805	42942000	171311	0100221311	100295
19505104300	160353	773592	100511	44847000	170998	0100221806	100566
19505110430	160353	9946866	180875	44847536	171000	0100222101	100258
195051104300	160353			44848000	170999	0100222301	100583
241101601	181585	ALFATRONIX		44849000	171098	0100222302	100262
4339371	160265	DD1224072	160642	44904000	171329	0100222304	100262
46072001	100511	DD1224168	160644	44904535	171330	0100222307	100262
46451951	100534	DD1224240	160646	44905000	171328	0100226125	100251
46469865	181395	DD1224400	161072	44954536	171162	0100226129	100307
46469917	181495	DD1224600	161073	55631000	171164	0100226134	100512
46472179	181395	DDI2424072	161074	55951000	171166	0100226164	100512
46481639	150451	DDI2424108	161075	77163000	170927	0100226171	100306
46533308	181495	DDI2424168	161076	77163133	170989	0100226172	100436
46548037	150246	DDI2424240	161077	77164000	170925	0100226173	100512
510621	150809	IC23012240	160875	77306000	170943	0100226175	100327
511000000000000	150395	IC23024300	160874	77309135	170944	0100226180	100257
530623	160265	MPV15	160580			0100226184	100323
531417	160265	MPV6	160579	AUDI → VW		0100226185	100511
54216200000000	150055	PT10	161014	BEHR BOSCH		0100226186	100511
55202374	150759	PT100	161018	192145	192145	0100226188	100335
55233423	150806	PT20	161015			0100226190	100303
55354325	150766	PT200	161019	BERLIT		0100226194	100287
59469230	160354	PT40	161016	25838009	090202	0100226198	100303
5963516	181584	PT60	161017	3005810	090076	0100226203	100561
60504190	150809	PV12L	160392	3008010	080696	0100226207	100292
605042880	150055	PV12S	160306	3008077	080696	0100226208	100426
60506902	180634	PV18L	161079	3020501	090016	0100226210	100339
60506988	181009	PV18S	161080			0100226227	100436
60507690	181585	PV24L	161081	BERU		0100226229	100511
6051 81 310	181585	PV24S	160389	0040100013	150428	0100226234	100331
60513205	180875	PV3I	160390	0040100109	150917	0100226235	100339
60518131	181585	PV3S	160387	0040100122	150913	0100226237	100512
605183220	070054	PV50S	160640	0040100234	150252	0100226238	100529
605215090	160265	PV6I	160391	0040100250	150891	0100226242	100283
605219920	070054	PV6S	160388	0040100259	150521	0100226243	100260
605228760	160352			0040100274	150901	0100226245	100532
605229970	150055	ALLIS		0040100277	150901	0100226248	100531
605343160	160353	4061262	080696	0040100296	150915	0100226250	100337
60537203	180985			0040100298	150914	0100226253	100669
605460910	070053	AMC		0040100298	150914	0100226256	100538
60549313	181001	3236666	181584	0040100320	150903	0100226260	100537
60558152	150252	3238765	181584	0040100345	150899	0100226269	100432
605581530	150379	3240083	181584	0040102051	150636	0100226300	100544
60562701	150570	33000598	181584	0040402011	150896	0100226301	100565
60564432	181001	7700708955	181584	0100100305	100079	0100226336	100515
60567759	181585	7700729963	181584	0100101308	100079	0100226338	100538
60585603	181021	8131941	150058	0100220101	100512	0100226344	100533
60586072	150252	8134117	150062	0100220103	100512	0100226351	100646
60593844	150759	8933000598	181584	0100220114	100251	0100226352	100666
60593845	150759	8933002455	181584	0100220118	100271	0100226362	100536
60593845	150805	8953000886	181584	0100220119	100271	0100226366	100541

OE No.	HC-CARGO	OE No.	HC-CARGO	OE No.	HC-CARGO	OE No.	HC-CARGO
0100226367	100531	40100275	150270	824331026	150768	GN039	100666
0100226372	100534	40100283	150246	824331026	150777	GN041	100645
0100226373	100436	40100297	150557	824331026	150783	GN042	100590
0100226375	100592	40100322	150609	824331026	150798	GN043	100283
0100226376	100671	40100338	150633	824331027	150768	GN045	100622
0100226379	100537	40100341	150259	824331027	150777	GN046	100527
0100226384	100565	40100342	150525	824331027	150783	GN047	100593
0100226385	100561	40100344	150668	824331027	150798	GN053	100627
0100226391	100639	40100348	150653	824331028	150768	GN054	100674
0100226395	100537	40100354	150433	824331028	150783	GN055	100675
0100226397	100538	40100387	150558	824331028	150798	GN056	100663
0100226417	100594	40100395	150572	824331029	150764	GN059	100642
0100226419	100537	40102021	150648	824331029	150768	GN061	100657
0100226422	100595	40102025	150619	824331030	150764	GN062	100661
0100226458	100537	40102026	150403	824331030	150768	GN063	100664
0100226460	100538	40102029	150641	824331030	150777	GN104	100555
0100226474	100527	40102030	150509	824331030	150783	GN106	100662
0100226475	100283	40102033	150656	824331030	150798	GN107	100670
0100226480	100590	40102034	150508	824331031	150786	GN109	100653
0100226482	100527	40102035	150416	824331032	150768	GN855	100436
0100226489	100594	40102043	150508	824331032	150777	GN858	100331
0100226492	100674	40102044	150635	824331032	150783	GN912	100335
0100226494	100675	40102045	150520	824331032	150798	GN927	100303
0100226497	100555	40102047	150522	824331033	150786	GN939	100561
0100226511	100670	40102059	150513	824331039	150809	GN961	100337
0100226522	100661	40102131	150666	824331062	150773	GN963	100532
0100226525	100662	40402001	150227	824331068	150799	GN967	100283
0100230102	100252	40402003	150435	844MJ	100512	GN970	100650
0100231114	100282	502MJ	100245	853MJ	100306	GN984	100669
0100266002	100641	512MJ	100252	854MJ	100306	GN992	100544
0100266004	100625	513MJ	100247	855MJ	100436	GN993	100565
0100266007	100652	514MJ	100254	857MJ	100512	GR001	160420
0100266008	100624	515MJ	100258	858MJ	100331	GR031	160421
0100266009	100625	517MJ	100280	860MJ	100327	GR034	160432
0100266011	100652	551MJ	100251	885MJ	100280	GR049	160442
0100266016	100673	555MJ	100260	886MJ	100257	GR054	160436
0100276002	100622	557MJ	100257	889MJ	100251	GR059	160423
0100276004	100593	571MJ	100271	890MJ	100252	GR061	160451
0100276005	100622	576MJ	100276	892MJ	100254	GR064	160416
0100276006	100622	577MJ	100277	894MJ	100258	GR065	160424
0100276007	100627	580MJ	100280	905MJ	100323	GR066	160425
0100276008	100627	582MJ	100282	909MJ	100511	GR067	160438
0100276012	100663	583MJ	100283	912MJ	100335	GV107	100583
0100276015	100642	587MJ	100287	918MJ	100303	GV155	100566
0100800031	100653	591MJ	100291	920MJ	100271	GV626	100295
0101022604	100177	592MJ	100292	921MJ	100287	GV657	100284
0101072603	100177	601MJ	100511	946MJ	100292	GV666	100303
0824331004	180634	602MJ	100511	947MJ	100426	GV889	100251
0824331010	180634	603MJ	100511	948MJ	100339	GV920	100271
0824331011	180634	604MJ	100303	950MJ	100436	GV968	100260
0824331025	180634	605MJ	100511	954MJ	100511	SPR042	150779
105MN	100511	607MJ	100511	961MJ	100337	SPR043	150760
107MJ	100262	609MJ	100511	966MJ	100531	SPR044	150773
108MJ	100262	611MJ	100295	967MJ	100283	SPR046	150769
112M	100263	613MJ	100511	968MJ	100291	SPR050	150799
124MJ	100262	626MJ	100295	969MJ	100282	WS015	080388
137MJ	100086	627MJ	100511	999MJ	100529	ZM001	150055
141MJ	100512	631MJ	100303	GE100	100624	ZM002	150056
151MJ	100511	633MJ	100511	GE101	100625	ZM003	150057
154GS	100177	636MJ	100511	GE102	100641	ZS016	150428
161MJ	100511	642MJ	100511	GE105	100652	ZS045	150520
162MJ	100512	654MJ	100511	GE108	100673	ZS052	150505
171MJ	100262	657MJ	100284	GN003	100537	ZS053	150625
2901520015	080388	661MJ	100303	GN005	100515	ZS106	150395
348GK	100079	666MJ	100303	GN007	100527	ZS109	150917
382GK	100079	673MJ	100246	GN008	100538	ZS120	150543
40100016	150428	678MJ	100256	GN013	100541	ZS232	150259
40100022	150435	688MJ	100260	GN016	100335	ZS234	150252
40100052	150505	705MJ	100261	GN017	100534	ZS243	150434
40100071	150505	718MJ	100331	GN018	100684	ZS244	150612
40100106	150395	719MJ	100545	GN019	100592	ZS250	150891
40100120	150543	725MJ	100436	GN020	100671	ZS259	150521
40100126	150669	727MJ	100511	GN022	100531	ZS274	150901
40100232	150259	749MJ	100245	GN024	100536	ZS275	150270
40100234	150252	783MJ	100307	GN026	100646	ZS277	150901
40100243	150434	819MJ	100616	GN027	100533	ZS283	150246
40100244	150612	824331011	180634	GN030	100639	ZS296	150915
40100259	150521	824331025	180634	GN033	100594	ZS297	150557
40100266	150638	824331026	150764	GN035	100595	ZS298	150914

ACCESSORIES

O. E. M. names and numbers are used for reference purposes only.

OE No.	HC-CARGO	OE No.	HC-CARGO	OE No.	HC-CARGO	OE No.	HC-CARGO
BERU continued							
ZS320	150903	11781741317	181586	16781405324	181588	01301111162	160710
ZS322	150609	11781742023	181586	1710509	150761	01301111164	160767
ZS338	150633	11781747005	181586	17105092A	150761	02100100001	160420
ZS340	150424	11787530285	181590	1730159	150761	0221118322	150526
ZS341	150259	11787530287	181590	1730578	150761	0221118332	150526
ZS342	150525	11787539125	181591	17781405324	181588	0221118335	150527
ZS344	150668	11787539126	181591	18781405324	181588	0221118351	150528
ZS348	150653	11787539137	181591	19781405324	181588	0221118382	150526
ZS354	150433	11787544654	181591	20781405324	181588	0221118383	150526
ZS387	150558	11787544655	181591	21781405324	181588	0221118442	150527
ZS427	150650	11787545074	181591	22781405324	181588	0221119021	150529
ZS476	150889	11787545075	181591	2367061	150761	0221119025	150530
ZS478	150902	1179232	070053	23781405324	181588	0221119027	150395
ZSE001	150227	12121286059	100511	24781405324	181588	0221119027	150531
ZSE003	150435	12121288161	100511	25781405324	181588	0221119030	150532
ZSE011	150896	12121357296	150395	26781405324	181588	0221119031	150533
ZSE021	150648	12131273216	150541	27781405324	181588	0221119046	150534
ZSE025	150619	12131286087	150913	28781405324	181588	0221119355	150535
ZSE026	150403	12131357240	150917	29781405324	181588	0221121001	150536
ZSE029	150641	12131357296	150395	30781405324	181588	0221122004	150537
ZSE030	150509	12131359637	150395	31781405324	181588	0221122008	150538
ZSE033	150656	12131742925	150550	32781405324	181588	0221122012	150539
ZSE034	150508	12137523345	150574	61311243086	160316	0221122014	150540
ZSE035	150416	12137548553	150574	61311243414	150772	0221122319	150541
ZSE040	150620	12137550012	150608	61311243414	180648	0221122327	150542
ZSE043	150508	12137551260	150573	61311350645	180734	0221122334	150543
ZSE044	150635	12137559842	150576	61311351799	180634	0221122345	150544
ZSE047	150522	12137571643	150575	61311354272	150772	0221122362	150545
ZSE059	150513	12137575010	150608	61311354272	180648	0221122367	150546
ZSE088	150623	12137594596	150560	61311354273	180648	0221122379	150508
ZSE145	150574	12137594936	150574	61311354274	150772	0221122392	150547
ZSE151	150640	12137594937	150575	61311354274	180648	0221122402	150548
ZSE266	150638	12138616153	150560	61311354393	160083	0221122450	150669
ZSE350	150416	12141244089	150056	61311357073	181034	0221502002	150549
ZSS345	150899	12141244191	150056	61311358170	160168	0221502009	150550
		12141244226	150056	61311364272	181034	0221502429	150551
		12141244477	150056	61311368786	180734	0221502460	150552
		12141244481	150056	61311378830	180734	0221503011	150553
		12141266702	150055	61311379830	180734	0221503022	150554
		12141273217	150055	61312204493	160654	0221503024	150555
		12141273298	150055	61661367616	160197	0221503025	150259
		12141274698	150055	61661368569	160197	0221503025	150556
		12141461441	150379	61661368585	160197	0221503025	150557
		12230035934	100679	61661368589	160197	0221503407	150252
		12232248059	100536	61661380066	160680	0221503472	150633
		12237786869	100641	64116933663	261322	0221503485	150558
		12237791101	100590	64118372493	261315	0221503487	150559
		12237803368	100679	64118385558	261316	0221503490	150416
		12411266702	150055	64118390851	261315	0221503491	150416
		12512247471	192902	64119144200	261322	0221504001	150561
		12611277642	150772	64119227670	261322	0221504017	150562
		12611277642	180631	7568480	150761	0221504020	150563
		12611710509	150761	7620512	150761	0221504024	150564
		12611730160	150761	7786869	100641	0221504026	150565
		12612367061	150761	7920100	160216	0221504027	150566
		12617568480	150761	7920100	160337	0221504030	150567
		12617620512	150761	8611273	150761	0221504034	150568
		12618611273	150761			0221504035	150569
		1277565	181584			0221504456	150570
		12781405324	181588	BOMAG		0221504460	150571
		13532247156	081115	05716363	090015	0221504461	150572
		13537785722	081209	05726030	080390	0221504464	150573
		1354273	180648	05726781	090076	0221504465	150574
		13621284397	180875	05727558	080692	0221504470	150575
		13621401945	180875	09331628	080696	0221504471	150576
		13621433565	181500			0221504477	150576
		13621709966	180875			0221504800	150608
		13622247074	181500	BOSCH		0221504801	150576
		13627787076	181500	0025428319	160365	0221505423	150577
		13631273139	160416	0025428419	160365	0221506002	150578
		13631276264	160352	01227022030	150227	0221506003	150424
		1364272	181034	01227030030	150227	0221506007	150424
		13712247002	181500	0130007001	160674	0221506444	150424
		13781405324	181588	0130063008	160626	0221506445	150424
		14781405324	181588	0130063013	160626	0221600005	150098
		15781405324	181588	0130063015	160626	0221600006	150056
		16121115862	070053	0130063025	160626	0221600008	150056
		16141178751	070053	0130063032	160626	0221600011	150056
		16141179232	070053	0130111003	160622	0221600015	150055
				0130111130	161719	0221600017	150055
				0130111134	160734	0221600052	150055

OE No.	HC-CARGO	OE No.	HC-CARGO	OE No.	HC-CARGO	OE No.	HC-CARGO
0221600065	150579	0250200051	100086	0250202038	100675	0258001037	181584
0221601003	150227	0250200052	100512	0250202040	100307	0258001038	181584
0221601004	150227	0250200053	100284	0250202042	100544	0258001039	181584
0221601005	150227	0250200054	100511	0250202043	100594	0258001040	181584
0221603006	150435	0250200055	100583	0250202046	100527	0258001041	181584
0221603009	150435	0250200056	100511	0250202048	100674	0258001042	181584
0221603010	150435	0250200058	100511	0250202051	100257	0258001043	181584
0221604006	150580	0250200059	100511	0250202052	100283	0258001044	181584
0221604010	150581	0250200060	100511	0250202053	100291	0258001047	181584
0221604014	150582	0250200061	100511	0250202054	100258	0258001051	181584
0221604022	150583	0250200063	100512	0250202060	100287	0258001052	181584
0221604024	150584	0250200065	100511	0250202064	100276	0258001060	181584
0221604032	150585	0250200066	100303	0250202065	100657	0258001061	181584
0221604103	150586	0250200068	100511	0250202069	100252	0258001062	181584
0221604109	150587	0250200069	100511	0250202073	100277	0258001063	181584
0221604109	150656	0250200420	100262	0250202077	100271	0258001064	181584
0221604112	150588	0250200451	100086	0250202085	100292	0258001097	181584
0221604113	150656	0250200454	100511	0250202087	100426	0258001248	181584
0221604115	150589	0250200456	100511	0250202089	100515	0258001929	181584
0227010001	150056	0250200465	100511	0250202090	100668	0258001931	181584
0227100023	150154	0250200468	100511	0250202092	100670	0258001947	181584
0227100024	150154	0250201001	100511	0250202093	100306	0258001960	181584
0227100029	150058	0250201004	100511	0250202094	100246	0258001961	181584
0227100042	150154	0250201006	100511	0250202095	100283	0258001962	181584
0227100043	150154	0250201008	100511	0250202096	100260	0258001963	181584
0227100100	150056	0250201009	100511	0250202102	100538	0258001964	181584
0227100101	150056	0250201010	100295	0250202103	100536	0258002014	181584
0227100102	150055	0250201011	100511	0250202105	100658	0258002024	181584
0227100103	150056	0250201012	100284	0250202110	100247	0258002029	181584
0227100104	150056	0250201015	100511	0250202119	100280	0258002030	181584
0227100110	150055	0250201017	100303	0250202120	100658	0258002035	181584
0227100111	150055	0250201019	100511	0250202121	100559	0258002038	181584
0227100112	150055	0250201026	100331	0250202125	100556	0258002040	181584
0227100113	150056	0250201027	100545	0250202126	100548	0258002041	181584
0227100114	150154	0250201029	100511	0250202128	100646	0258002044	181584
0227100115	150154	0250201031	100512	0250202129	100592	0258002049	181584
0227100116	150056	0250201032	100512	0250202130	100561	0258002050	181584
0227100118	150056	0250201033	100511	0250202131	100565	0258002052	181584
0227100120	150056	0250201034	100284	0250202135	100674	0258002053	181584
0227100123	150055	0250201035	100327	0250202137	100555	0258002054	181584
0227100124	150098	0250201038	100339	0250202140	100337	0258002055	181584
0227100126	150154	0250201039	100511	0250202142	100337	0258002057	181584
0227100129	150154	0250201041	100331	0250203001	100642	0258002061	181584
0227100136	150154	0250201042	100541	0250203002	100627	0258002203	181584
0227100137	150056	0250201049	100531	0250203004	100622	0258002909	181584
0227100138	150056	0250201050	100512	0250203012	100664	0258002919	181584
0227100139	150056	0250201053	100639	0250204001	100593	0258003001	181585
0227100140	150057	0250201054	100339	0250204002	100663	0258003003	181585
0227100142	150075	0250201055	100331	0250212006	100595	0258003004	181585
0227100143	150075	0250201405	100511	0250212009	100684	0258003005	181585
0227100145	150098	0250201415	100511	0250212013	100536	0258003006	181585
0227100147	150075	0250201904	100511	0250212018	100538	0258003008	181585
0227100148	150055	0250201905	100512	0250312001	100302	0258003009	181585
0227100149	150098	0250201933	160420	0250312002	100326	0258003010	181585
0227100200	150379	0250201952	160424	0250312003	100513	0258003011	181585
0227100201	150379	0250202001	100303	0250312007	100510	0258003012	181585
0227100203	150387	0250202003	100246	0250402001	100624	0258003013	181585
0227100204	150379	0250202004	100256	0250402002	100641	0258003014	181585
0227100208	150387	0250202006	100260	0250402005	100624	0258003015	181585
0227100209	150409	0250202007	100261	0250403002	100625	0258003016	181585
0227100210	150409	0250202008	100245	0250403003	100660	0258003017	181585
0227100211	150406	0250202009	100436	0250403008	100652	0258003018	181585
0227100212	150406	0250202014	100251	0250403010	100660	0258003019	181585
0227100213	150379	0250202017	100254	0250603001	100676	0258003020	181587
0227100214	150387	0250202018	100303	0250603004	100683	0258003021	181585
0227100215	150379	0250202020	100335	0250603006	100679	0258003023	181585
0227200005	150056	0250202021	100432	0250603008	100665	0258003024	181585
0232101009	150496	0250202022	100436	0257100010	100177	0258003025	181585
0232101023	150496	0250202023	100527	0258001012	181584	0258003026	181585
0232101030	150496	0250202024	100432	0258001014	181584	0258003027	181585
0250001008	100079	0250202025	100323	0258001021	181584	0258003028	181585
0250001012	100079	0250202026	100337	0258001025	181584	0258003030	181585
0250001016	100079	0250202028	100534	0258001026	181584	0258003031	181585
0250001416	100079	0250202029	100537	0258001027	181584	0258003032	181585
0250200001	100583	0250202030	100659	0258001028	181584	0258003034	181587
0250200014	100583	0250202032	100533	0258001029	181584	0258003035	181585
0250200020	100583	0250202034	100650	0258001031	181584	0258003036	181585
0250200035	100263	0250202035	100532	0258001032	181584	0258003037	181589
0250200037	100566	0250202036	100645	0258001035	181584	0258003038	181586

ACCESSORIES

O. E. M. names and numbers are used for reference purposes only.

OE No.	HC-CARGO	OE No.	HC-CARGO	OE No.	HC-CARGO	OE No.	HC-CARGO
BOSCH continued							
0258003039	181585	0258003132	181585	0258003224	181590	0258003317	181586
0258003040	181585	0258003133	181585	0258003225	181590	0258003318	181589
0258003041	181585	0258003134	181585	0258003226	181590	0258003319	181589
0258003043	181585	0258003135	181585	0258003227	181590	0258003320	181589
0258003044	181585	0258003136	181585	0258003228	181590	0258003321	181589
0258003045	181586	0258003137	181585	0258003229	181589	0258003322	181589
0258003046	181585	0258003138	181585	0258003231	181586	0258003323	181589
0258003047	181585	0258003139	181585	0258003232	181585	0258003324	181589
0258003048	181585	0258003140	181585	0258003233	181585	0258003325	181589
0258003049	181585	0258003141	181585	0258003236	181586	0258003326	181586
0258003050	181585	0258003142	181585	0258003237	181586	0258003327	181586
0258003051	181589	0258003143	181585	0258003238	181589	0258003328	181586
0258003052	181589	0258003144	181587	0258003239	181589	0258003329	181586
0258003054	181585	0258003145	181587	0258003240	181589	0258003330	181590
0258003056	181585	0258003146	181587	0258003241	181587	0258003331	181585
0258003057	181585	0258003147	181587	0258003242	181587	0258003332	181585
0258003058	181585	0258003148	181587	0258003243	181585	0258003333	181589
0258003059	181585	0258003149	181587	0258003244	181586	0258003334	181586
0258003060	181585	0258003150	181587	0258003245	181585	0258003335	181588
0258003061	181585	0258003151	181587	0258003246	181585	0258003336	181588
0258003062	181586	0258003152	181587	0258003247	181587	0258003337	181585
0258003063	181585	0258003153	181587	0258003248	181587	0258003338	181586
0258003064	181586	0258003154	181585	0258003249	181587	0258003339	181590
0258003065	181588	0258003155	181585	0258003250	181587	0258003340	181590
0258003067	181586	0258003156	181585	0258003251	181589	0258003341	181590
0258003068	181586	0258003157	181585	0258003252	181589	0258003342	181590
0258003069	181586	0258003160	181585	0258003253	181589	0258003343	181590
0258003070	181587	0258003161	181585	0258003254	181587	0258003346	181587
0258003072	181585	0258003162	181585	0258003256	181585	0258003347	181587
0258003073	181585	0258003163	181586	0258003257	181585	0258003349	181585
0258003074	181589	0258003164	181585	0258003258	181587	0258003351	181587
0258003075	181585	0258003165	181585	0258003259	181589	0258003352	181589
0258003076	181589	0258003166	181585	0258003260	181586	0258003353	181586
0258003077	181585	0258003169	181587	0258003261	181586	0258003354	181586
0258003078	181589	0258003170	181587	0258003262	181589	0258003355	181589
0258003079	181587	0258003171	181587	0258003263	181585	0258003356	181588
0258003080	181585	0258003172	181587	0258003264	181585	0258003357	181586
0258003081	181585	0258003173	181585	0258003267	181586	0258003358	181589
0258003082	181585	0258003174	181585	0258003268	181586	0258003359	181586
0258003083	181587	0258003175	181585	0258003271	181586	0258003360	181589
0258003084	181585	0258003177	181590	0258003273	181585	0258003363	181587
0258003085	181587	0258003178	181590	0258003274	181585	0258003365	181589
0258003086	181585	0258003181	181585	0258003275	181590	0258003366	181589
0258003087	181589	0258003182	181585	0258003276	181585	0258003367	181589
0258003088	181586	0258003183	181590	0258003277	181585	0258003368	181589
0258003090	181585	0258003184	181590	0258003278	181587	0258003369	181588
0258003091	181587	0258003185	181590	0258003279	181585	0258003370	181585
0258003092	181587	0258003186	181590	0258003283	181585	0258003373	181589
0258003093	181585	0258003187	181590	0258003284	181585	0258003374	181588
0258003094	181585	0258003188	181590	0258003285	181587	0258003375	181588
0258003095	181587	0258003189	181585	0258003286	181585	0258003376	181585
0258003096	181585	0258003190	181585	0258003287	181585	0258003377	181587
0258003097	181585	0258003191	181587	0258003288	181586	0258003378	181587
0258003099	181585	0258003192	181587	0258003289	181586	0258003379	181587
0258003101	181585	0258003193	181589	0258003290	181589	0258003380	181587
0258003102	181585	0258003194	181585	0258003291	181589	0258003381	181585
0258003103	181589	0258003195	181586	0258003292	181589	0258003382	181590
0258003104	181585	0258003196	181586	0258003293	181585	0258003383	181590
0258003105	181585	0258003197	181586	0258003294	181585	0258003384	181590
0258003106	181585	0258003198	181586	0258003297	181585	0258003385	181590
0258003108	181586	0258003199	181586	0258003298	181585	0258003386	181590
0258003109	181586	0258003200	181586	0258003299	181585	0258003387	181590
0258003112	181585	0258003201	181585	0258003300	181585	0258003388	181590
0258003113	181585	0258003202	181586	0258003301	181589	0258003389	181590
0258003114	181587	0258003203	181589	0258003302	181589	0258003390	181589
0258003115	181587	0258003204	181586	0258003303	181589	0258003391	181586
0258003116	181587	0258003206	181585	0258003304	181589	0258003392	181590
0258003117	181587	0258003209	181585	0258003305	181587	0258003393	181585
0258003118	181589	0258003211	181585	0258003306	181587	0258003394	181588
0258003119	181587	0258003212	181585	0258003307	181590	0258003395	181588
0258003120	181589	0258003213	181585	0258003308	181587	0258003396	181585
0258003122	181585	0258003215	181586	0258003309	181589	0258003397	181585
0258003123	181585	0258003216	181589	0258003310	181586	0258003398	181590
0258003125	181590	0258003217	181589	0258003311	181585	0258003399	181590
0258003127	181590	0258003218	181590	0258003312	181585	0258003401	181590
0258003128	181590	0258003219	181586	0258003313	181585	0258003402	181590
0258003129	181590	0258003220	181586	0258003314	181586	0258003403	181586
0258003130	181585	0258003222	181589	0258003315	181586	0258003414	181588
0258003131	181585	0258003223	181590	0258003316	181586	0258003415	181588

OE No.	HC-CARGO	OE No.	HC-CARGO	OE No.	HC-CARGO	OE No.	HC-CARGO
0258003417	181585	0258003521	181590	0258003631	181588	0258003744	181587
0258003418	181585	0258003522	181586	0258003632	181586	0258003745	181588
0258003419	181585	0258003523	181586	0258003633	181586	0258003746	181588
0258003420	181585	0258003524	181585	0258003634	181585	0258003748	181588
0258003421	181585	0258003525	181585	0258003635	181585	0258003749	181588
0258003422	181587	0258003526	181588	0258003636	181589	0258003750	181588
0258003423	181590	0258003528	181586	0258003637	181589	0258003751	181588
0258003425	181588	0258003533	181590	0258003638	181588	0258003752	181588
0258003426	181586	0258003535	181590	0258003639	181588	0258003754	181586
0258003427	181586	0258003537	181590	0258003640	181588	0258003757	181588
0258003428	181586	0258003538	181586	0258003641	181588	0258003758	181588
0258003429	181586	0258003539	181586	0258003642	181588	0258003759	181590
0258003430	181586	0258003540	181589	0258003643	181588	0258003760	181590
0258003431	181586	0258003541	181590	0258003644	181590	0258003762	181590
0258003432	181586	0258003542	181588	0258003645	181588	0258003763	181587
0258003433	181586	0258003543	181588	0258003648	181589	0258003764	181587
0258003434	181586	0258003544	181590	0258003649	181589	0258003765	181587
0258003436	181588	0258003548	181586	0258003652	181585	0258003766	181587
0258003439	181586	0258003549	181586	0258003653	181585	0258003769	181589
0258003440	181586	0258003550	181588	0258003654	181588	0258003770	181589
0258003441	181587	0258003551	181588	0258003655	181588	0258003771	181588
0258003443	181586	0258003552	181588	0258003656	181588	0258003772	181589
0258003444	181586	0258003553	181588	0258003657	181588	0258003773	181588
0258003445	181585	0258003554	181587	0258003658	181588	0258003774	181585
0258003446	181585	0258003555	181587	0258003659	181590	0258003775	181590
0258003447	181585	0258003556	181590	0258003660	181590	0258003776	181590
0258003448	181585	0258003557	181590	0258003661	181588	0258003778	181590
0258003450	181589	0258003558	181588	0258003662	181588	0258003779	181590
0258003451	181589	0258003559	181588	0258003664	181586	0258003780	181590
0258003453	181586	0258003560	181586	0258003666	181586	0258003781	181590
0258003456	181590	0258003561	181588	0258003667	181589	0258003782	181588
0258003457	181590	0258003564	181588	0258003669	181589	0258003783	181588
0258003458	181588	0258003567	181589	0258003671	181589	0258003784	181586
0258003459	181588	0258003568	181589	0258003672	181589	0258003785	181586
0258003460	181586	0258003569	181585	0258003673	181589	0258003786	181586
0258003461	181585	0258003570	181589	0258003674	181586	0258003787	181586
0258003462	181589	0258003571	181589	0258003678	181590	0258003788	181586
0258003463	181589	0258003572	181589	0258003679	181590	0258003789	181586
0258003464	181589	0258003573	181589	0258003681	181590	0258003790	181586
0258003465	181586	0258003574	181589	0258003683	181590	0258003791	181586
0258003466	181589	0258003575	181586	0258003684	181588	0258003792	181586
0258003467	181590	0258003576	181586	0258003685	181588	0258003793	181586
0258003468	181590	0258003577	181588	0258003686	181589	0258003794	181588
0258003469	181589	0258003578	181589	0258003687	181586	0258003795	181588
0258003470	181588	0258003579	181589	0258003689	181588	0258003797	181588
0258003472	181590	0258003580	181588	0258003692	181588	0258003798	181588
0258003473	181585	0258003581	181588	0258003693	181588	0258003799	181588
0258003474	181585	0258003582	181588	0258003698	181588	0258003800	181588
0258003475	181588	0258003583	181588	0258003699	181588	0258003801	181588
0258003476	181588	0258003584	181589	0258003700	181586	0258003802	181588
0258003477	181588	0258003585	181589	0258003703	181585	0258003805	181589
0258003478	181588	0258003586	181586	0258003704	181585	0258003806	181588
0258003479	181588	0258003588	181586	0258003705	181586	0258003807	181588
0258003481	181590	0258003590	181590	0258003709	181586	0258003808	181589
0258003483	181585	0258003591	181590	0258003710	181586	0258003809	181589
0258003484	181590	0258003592	181588	0258003711	181590	0258003810	181586
0258003485	181590	0258003593	181588	0258003712	181590	0258003811	181588
0258003486	181590	0258003594	181588	0258003713	181590	0258003812	181588
0258003492	181590	0258003596	181586	0258003714	181590	0258003813	181590
0258003494	181590	0258003597	181586	0258003715	181585	0258003814	181590
0258003496	181590	0258003598	181586	0258003716	181589	0258003815	181590
0258003498	181590	0258003599	181586	0258003717	181589	0258003816	181590
0258003499	181590	0258003600	181586	0258003718	181589	0258003817	181588
0258003500	181590	0258003601	181586	0258003719	181589	0258003819	181590
0258003503	181585	0258003602	181586	0258003721	181588	0258003820	181588
0258003504	181585	0258003603	181588	0258003722	181588	0258003821	181585
0258003505	181585	0258003604	181586	0258003723	181588	0258003822	181585
0258003506	181590	0258003605	181586	0258003725	181590	0258003823	181588
0258003507	181590	0258003607	181590	0258003726	181590	0258003824	181588
0258003508	181585	0258003611	181588	0258003727	181590	0258003827	181585
0258003509	181585	0258003621	181590	0258003729	181590	0258003828	181585
0258003510	181585	0258003622	181585	0258003731	181590	0258003829	181586
0258003512	181586	0258003623	181585	0258003733	181590	0258003830	181586
0258003513	181589	0258003624	181585	0258003736	181588	0258003832	181585
0258003514	181589	0258003625	181585	0258003737	181588	0258003833	181585
0258003515	181589	0258003626	181588	0258003740	181588	0258003835	181590
0258003516	181589	0258003627	181589	0258003741	181588	0258003837	181590
0258003517	181586	0258003629	181590	0258003742	181585	0258003839	181590
0258003518	181588	0258003630	181588	0258003743	181585	0258003840	181588

ACCESSORIES

O. E. M. names and numbers are used for reference purposes only.

OE No.	HC-CARGO	OE No.	HC-CARGO	OE No.	HC-CARGO	OE No.	HC-CARGO
BOSCH continued							
0258003841	181585	0258005052	181590	0258005171	181588	0258005273	181589
0258003842	181588	0258005053	181590	0258005172	181588	0258005274	181585
0258003843	181588	0258005054	181588	0258005173	181588	0258005275	181585
0258003848	181588	0258005055	181590	0258005174	181590	0258005276	181589
0258003852	181585	0258005058	181586	0258005175	181588	0258005277	181589
0258003853	181585	0258005059	181586	0258005176	181588	0258005278	181589
0258003854	181588	0258005061	181590	0258005177	181588	0258005279	181589
0258003855	181590	0258005062	181588	0258005178	181586	0258005280	181588
0258003856	181590	0258005063	181588	0258005179	181588	0258005281	181588
0258003860	181588	0258005065	181588	0258005180	181588	0258005283	181588
0258003861	181588	0258005070	181590	0258005181	181587	0258005284	181589
0258003862	181588	0258005071	181590	0258005182	181588	0258005285	181589
0258003863	181588	0258005074	181588	0258005183	181588	0258005286	181589
0258003864	181588	0258005078	181588	0258005184	181588	0258005287	181589
0258003865	181588	0258005079	181588	0258005185	181588	0258005289	181585
0258003868	181586	0258005080	181588	0258005186	181588	0258005292	181590
0258003869	181586	0258005081	181588	0258005187	181588	0258005293	181590
0258003870	181590	0258005082	181588	0258005189	181588	0258005294	181590
0258003871	181590	0258005083	181590	0258005191	181590	0258005295	181590
0258003872	181590	0258005084	181590	0258005192	181586	0258005296	181590
0258003873	181590	0258005087	181589	0258005197	181590	0258005297	181588
0258003890	181590	0258005088	181588	0258005200	181588	0258005298	181588
0258003891	181590	0258005089	181588	0258005201	181588	0258005302	181590
0258003892	181585	0258005090	181588	0258005202	181588	0258005303	181588
0258003893	181590	0258005091	181588	0258005203	181588	0258005304	181588
0258003894	181590	0258005092	181588	0258005205	181588	0258005305	181588
0258003895	181588	0258005093	181588	0258005206	181588	0258005306	181588
0258003896	181588	0258005094	181588	0258005207	181588	0258005308	181585
0258003897	181585	0258005095	181588	0258005208	181588	0258005309	181588
0258003898	181585	0258005096	181586	0258005209	181588	0258005310	181588
0258003913	181585	0258005097	181588	0258005210	181588	0258005311	181588
0258003915	181585	0258005098	181588	0258005213	181589	0258005312	181590
0258003918	181585	0258005099	181588	0258005214	181589	0258005314	181586
0258003924	181585	0258005109	181588	0258005215	181589	0258005315	181586
0258003925	181585	0258005110	181590	0258005216	181589	0258005316	181586
0258003926	181585	0258005112	181588	0258005219	181588	0258005317	181586
0258003930	181585	0258005113	181588	0258005220	181588	0258005318	181586
0258003931	181585	0258005115	181590	0258005221	181588	0258005321	181588
0258003936	181585	0258005116	181590	0258005222	181588	0258005322	181586
0258003942	181585	0258005119	181588	0258005223	181585	0258005323	181586
0258003943	181585	0258005121	181588	0258005224	181585	0258005324	181586
0258003950	181585	0258005123	181588	0258005226	181589	0258005325	181586
0258003953	181585	0258005124	181588	0258005227	181589	0258005327	181586
0258003956	181585	0258005125	181589	0258005228	181586	0258005328	181585
0258003957	181585	0258005126	181586	0258005229	181586	0258005329	181585
0258003965	181588	0258005127	181586	0258005236	181588	0258005334	181585
0258003970	181587	0258005128	181586	0258005237	181588	0258005335	181588
0258003972	181585	0258005129	181586	0258005238	181585	0258005650	181590
0258003973	181585	0258005130	181586	0258005239	181585	0258005651	181588
0258003979	181587	0258005131	181586	0258005240	181590	0258005652	181588
0258003980	181585	0258005132	181588	0258005241	181590	0258005653	181588
0258003994	181585	0258005133	181588	0258005242	181590	0258005654	181590
0258003995	181587	0258005134	181590	0258005243	181590	0258005657	181589
0258003999	181585	0258005135	181590	0258005244	181588	0258005658	181590
0258005001	181590	0258005136	181590	0258005245	181588	0258005659	181590
0258005002	181590	0258005138	181588	0258005246	181587	0258005701	181587
0258005003	181588	0258005139	181588	0258005247	181588	0258005704	181590
0258005004	181588	0258005141	181590	0258005249	181590	0258005705	181590
0258005005	181588	0258005142	181590	0258005251	181590	0258005708	181590
0258005006	181588	0258005143	181588	0258005253	181590	0258005709	181590
0258005007	181588	0258005144	181588	0258005254	181590	0258005710	181590
0258005009	181590	0258005147	181586	0258005255	181590	0258005716	181590
0258005011	181590	0258005148	181586	0258005256	181590	0258005717	181590
0258005013	181590	0258005149	181586	0258005257	181586	0258005718	181590
0258005015	181590	0258005150	181586	0258005258	181588	0258005719	181590
0258005017	181590	0258005151	181586	0258005259	181588	0258005721	181590
0258005019	181590	0258005152	181586	0258005260	181587	0258005722	181590
0258005021	181590	0258005153	181588	0258005261	181590	0258005730	181590
0258005023	181590	0258005154	181588	0258005262	181590	0258005734	181590
0258005024	181588	0258005155	181588	0258005263	181590	0258005735	181590
0258005025	181588	0258005156	181589	0258005264	181590	0258005736	181590
0258005026	181588	0258005157	181589	0258005265	181590	0258005737	181590
0258005027	181588	0258005160	181588	0258005266	181590	0258005785	181590
0258005030	181586	0258005161	181588	0258005267	181589	0258005786	181590
0258005034	181590	0258005162	181590	0258005268	181589	0258005845	181590
0258005036	181590	0258005163	181590	0258005269	181589	0258005846	181590
0258005038	181590	0258005164	181590	0258005270	181588	0258005955	181585
0258005047	181589	0258005169	181590	0258005271	181588	0258005957	181589
0258005051	181589	0258005170	181588	0258005272	181589	0258005959	181589

OE No.	HC-CARGO	OE No.	HC-CARGO	OE No.	HC-CARGO	OE No.	HC-CARGO
BOSCH continued							
0258010166	181591	0258986638	181591	0280218010	181500	0332014119	160282
0258010167	181592	0258986641	181591	0280218012	181495	0332014125	160265
0258010174	181591	0258986642	181591	0280218013	181491	0332014126	160265
0258010175	181591	0258986643	181591	0280218014	181491	0332014134	160282
0258010176	181591	0258986644	181591	0280218019	181495	0332014138	160265
0258010177	181591	0258986645	181591	0280218031	181494	0332014139	160265
0258010178	181591	0258986646	181591	0280218034	181491	0332014140	160265
0258010179	181591	0258986647	181591	0280218035	181491	0332014150	160265
0258010180	181591	0258986648	181591	0280218051	181495	0332014151	160265
0258010181	181591	0258986649	181591	0280218063	181491	0332014157	160083
0258010190	181591	0258986650	181591	0280218064	181491	0332014201	160266
0258010196	181591	0258986651	181591	0280218108	181495	0332014203	160266
0258010200	181591	0258986652	181591	0280218471	181491	0332014207	160266
0258010201	181591	0258986653	181591	0280230001	160352	0332014213	160266
0258010202	181591	0258986654	181591	0280230005	160352	0332014406	160083
0258010203	181591	0258986655	181591	0280230006	160354	0332014409	160083
0258010204	181591	0258986657	181591	0280230009	160353	0332014415	160083
0258010207	181591	0258986659	181591	0280230014	160354	0332014451	160083
0258010218	181591	0258986660	181591	0280230016	160352	0332014453	160083
0258010220	181591	0258986662	181591	0280230018	160353	0332014454	160083
0258010225	181591	0258986663	181591	0281002169	181395	0332015001	160168
0258010227	181591	0258986664	181591	0281002170	181395	0332015002	160169
0258010231	181591	0258986665	181591	0281002209	181395	0332015008	160308
0258010232	181591	0258986667	181591	0281002214	150451	0332015008	160337
0258010233	181591	0258986668	181591	0281002318	181491	0332017100	160365
0258010235	181591	0258986669	181591	0281002319	181491	0332017101	160365
0258010236	181591	0258986672	181591	0281002448	181495	0332017102	160365
0258010239	181591	0258986673	181591	0281002462	181491	0332017103	160363
0258010247	181591	0258986674	181591	0281002464	181491	0332017104	160365
0258010252	181591	0258986675	181591	0281002473	181395	0332017300	160365
0258010256	181591	0258986676	181591	0281002474	150451	0332017302	160365
0258010323	181591	0258986678	181591	0281002478	181491	0332017303	160365
0258986007	181588	0258986680	181591	0281002531	181491	0332017315	160365
0258986501	181584	0258986681	181591	0281002532	181491	0332019103	160282
0258986502	181585	0258986683	181591	0281002555	181495	0332019140	160265
0258986502	181585	0258986684	181591	0281002659	150451	0332019150	160265
0258986503	181586	0258986685	181591	0281003005	160432	0332019151	160265
0258986503	181586	0258986687	181591	0281003006	160434	0332019156	160282
0258986504	181587	0258986690	181591	0281003009	160436	0332019157	160083
0258986504	181587	0258986692	181591	0281003012	160434	0332019159	160265
0258986505	181588	0258986694	181591	0281003018	161737	0332019165	160265
0258986505	181588	0258986695	181591	0281003039	161735	0332019203	160266
0258986506	181589	0258986696	181591	0281003056	161738	0332019205	160215
0258986506	181589	0258986697	181591	0281003083	161738	0332019205	160240
0258986507	181590	0258986698	181591	0281003087	161739	0332019451	160083
0258986507	181590	0258986699	181591	0281003089	161738	0332019453	160083
0258986601	181588	0258986701	181591	0281003096	160449	0332019454	160083
0258986602	181590	0258986702	181591	0281003098	160419	0332019456	160083
0258986602	181590	0258986703	181591	0281003099	160421	0332019457	160083
0258986602	181591	0258986705	181591	0290800022	150100	0332100003	160216
0258986602	181592	0258986709	181591	0290800028	150407	0332100011	160081
0258986603	181591	0258986711	181591	0290800036	150407	0332100012	160216
0258986604	181591	0258986712	181591	0290800044	150408	0332100013	160216
0258986605	181591	0258986713	181591	0290800052	150101	0332100017	160216
0258986606	181591	0258986716	181591	0306003003	172147	0332100020	160081
0258986607	181591	0258986718	181591	0306003006	172148	0332100021	160216
0258986608	181591	0258986719	181591	0330001015	080177	0332200003	160216
0258986609	181591	0258986720	181591	0330001016	080178	0332200006	160216
0258986611	181591	0261210114	150354	0330001018	080177	0332200009	160081
0258986612	181591	0261210124	150354	0330001040	081166	0332200010	160216
0258986613	181591	0261210151	150468	0330001041	080177	0332200013	160081
0258986615	181591	0261210199	150470	0330106017	081002	0332200014	160216
0258986615	181592	0261210200	150470	0330106018	081000	0332200020	160081
0258986615	181592	0280130026	180875	0332003011	160265	0332200021	160081
0258986618	181591	0280130033	180875	0332003012	160266	0332201107	160919
0258986621	181591	0280130068	180875	0332003017	160265	0332201201	160337
0258986622	181591	0280130077	180875	0332003020	160266	0332204101	160308
0258986623	181591	0280130093	181395	0332003021	160265	0332204102	160081
0258986625	181591	0280130094	181395	0332003023	160265	0332204103	160308
0258986627	181591	0280130107	180875	0332005005	160168	0332204108	160081
0258986628	181591	0280217122	181491	0332005006	160169	0332204109	160403
0258986629	181591	0280217123	181495	0332011007	160363	0332204110	160081
0258986630	181591	0280217500	181500	0332014012	160265	0332204113	160308
0258986631	181591	0280217516	181500	0332014013	160265	0332204115	160081
0258986633	181591	0280217517	181500	0332014106	160282	0332204118	160308
0258986634	181591	0280217518	181500	0332014107	160265	0332204125	160081
0258986635	181591	0280217532	181500	0332014108	160265	0332204126	160081
0258986636	181591	0280217811	181500	0332014111	160265	0332204133	160403
0258986637	181591	0280218001	181495	0332014113	160265	0332204134	160081

OE No.	HC-CARGO	OE No.	HC-CARGO	OE No.	HC-CARGO	OE No.	HC-CARGO
0332204150	160081	0335200004	160242	0440003221	090015	0580464070	070053
0332204151	160308	0335200005	160244	0440003223	090202	0580810046	070053
0332204159	160403	0335200006	160244	0440003230	090015	0584640020	070053
0332204162	160403	0335200012	160242	0440003233	090202	0928400314	181500
0332204174	160081	0335200013	160242	0440003236	090015	0928400468	181500
0332204182	160403	0335200016	160244	0440003238	090015	0928400527	181500
0332204183	160081	0335200017	160244	0440003240	090202	0986034687	150772
0332204188	160081	0335200022	160242	0440003998	090202	0986221000	150227
0332204201	160337	0335200023	160242	0440004018	090016	0986221000	150590
0332204202	160337	0335200027	160242	0440004019	090016	0986221001	150505
0332204203	160216	0335200028	160242	0440004020	090016	0986221005	150638
0332204204	160216	0335200029	160244	0440004027	090016	0986221006	150896
0332204206	160337	0335200030	160244	0440004028	090016	0986221011	150428
0332204207	160216	0335200031	160244	0440004032	090016	0986221023	150509
0332204212	160271	0335200035	160242	0440004033	090016	0986221024	150508
0332204215	160337	0335200036	160242	0440004034	090016	0986221026	150434
0332204216	160216	0335200037	160244	0440004042	090016	0986221027	150612
0332204402	160316	0335200038	160242	0440004043	090016	0986221034	150634
0332204407	160316	0335200041	160244	0440004047	090016	0986221035	150522
0332204801	160081	0335200043	160242	0440004052	090016	0986221036	150441
0332207100	160919	0335200044	160244	0440004058	090016	0986221039	150521
0332207101	160919	0335200045	160242	0440004064	090016	0986221040	150625
0332207102	160919	0335200050	160305	0440004068	090016	0986221043	150609
0332207104	160366	0335200051	160305	0440008007	090020	0986221045	150505
0332207107	160919	0335200052	160242	0440008020	090020	0986221046	150624
0332207200	160521	0335200053	160242	0440008029	090020	0986221047	150513
0332207201	160521	0335200054	160242	0440008034	090020	0986221048	150435
0332207202	160368	0335200058	160242	0440008037	090020	0986221053	150636
0332207300	160919	0335200066	160242	0440008045	090020	0986221062	150627
0332207302	160919	0335200067	160244	0440008054	090020	0986221063	150632
0332207304	160366	0335200068	160242	0440008067	090020	0986221075	150889
0332207307	160919	0335200073	160242	0440008068	090315	0986221076	150902
0332207307	160919	0335200075	160242	0440008079	090315	0986221078	150626
0332207310	160919	0335200078	160243	0440008081	090315	0986221079	150666
0332207321	160919	0335200160	160263	0440008089	090198	0986221090	150623
0332207402	160521	0335215140	160262	0440011002	080793	0986221092	150610
0332207404	160521	0335215143	160262	0440011007	080793	0986221093	150668
0332207405	160521	0335215150	160199	0450126009L	090167	0986258006	181588
0332207406	160521	0335215154	160199	0450126957	090167	0986280206	181491
0332209137	160403	0335402009	160262	0450133186	090381	0986280210	181491
0332209138	160081	0341003004	181599	0450904060	RT2002	0986280211	181491
0332209150	160081	0344101032	180634	0455126043	090167	0986280217	181491
0332209151	160308	0344101033	180634	0455522043	090167	0986280223	181491
0332209153	160308	0344101040	150772	0580453076	070053	0986280230	181494
0332209156	160308	0344101040	180648	0580463010	070053	0986280231	181495
0332209157	160308	0344101044	180634	0580463011	070053	0986280408	150354
0332209158	160216	0344101046	150796	0580463012	070053	0986280411	150414
0332209159	160403	0344101056	180634	0580463013	070053	0986284002	181491
0332209161	160081	0344101060	180631	0580463014	070053	0986284009	181491
0332209162	160403	0344101071	180636	0580463015	070053	0986332003	160282
0332209167	160403	0344101082	180635	0580463016	070053	0986332004	160919
0332209201	160337	0344101085	180634	0580463017	070053	0986332040	160337
0332209202	160337	0344101086	150785	0580464008	070053	0986332041	160403
0332209203	160216	0344101086	180636	0580464010	070053	0986332080	161035
0332209204	160337	0354010001	190273	0580464011	070053	0986344033	180634
0332209205	160337	0354010001	191012	0580464013	070053	0986344036	150809
0332209206	160337	0392020024	070192	0580464014	070053	0986344040	150772
0332209207	160216	0392020026	070206	0580464015	070053	0986344040	180631
0332209209	160337	0392020034	070203	0580464016	070053	0986344058	180634
0332209211	160337	0434250128	100352	0580464017	070054	0986344082	180634
0332209216	160266	0440003007	090015	0580464019	070053	0986344085	180634
0332515022	160654	0440003148	090202	0580464020	070054	0986345000	150764
0333300003	180290	0440003176	090202	0580464021	070054	0986345000	150794
0333301007	180232	0440003177	090015	0580464022	070054	0986345001	150768
0333301009	180233	0440003182	090202	0580464023	070053	0986345001	180641
0333402501	160423	0440003184	090202	0580464024	070054	0986345003	150770
0333402505	160441	0440003185	090015	0580464025	070054	0986345003	150786
0333402506	160441	0440003188	090015	0580464027	070054	0986345004	150777
0333402507	160443	0440003189	090015	0580464028	070054	0986345004	150815
0333402508	160443	0440003190	090015	0580464032	070053	0986345006	150777
0333402509	160424	0440003191	090015	0580464033	070053	0986345006	150783
0333402512	160420	0440003193	090015	0580464037	070054	0986345006	150815
0333402513	160425	0440003195	090015	0580464038	070053	0986345007	150774
0333402515	160442	0440003196	090015	0580464042	070054	0986345008	180641
0333402516	160442	0440003199	090202	0580464044	070054	0986345009	150770
0333402517	160424	0440003203	090015	0580464045	070054	0986345011	150815
0333402524	160425	0440003204	090015	0580464048	070053	0986345012	150794
0334200045	160242	0440003212	090202	0580464050	070053	0986345017	150798
0335200003	160242	0440003220	090015	0580464069	070054	0986345017	180641

ACCESSORIES

O. E. M. names and numbers are used for reference purposes only.

OE No.	HC-CARGO	OE No.	HC-CARGO	OE No.	HC-CARGO	OE No.	HC-CARGO
BOSCH continued							
0986AH0603	160980	141701997	090441	2467010003	090212	2916680035	190506
0986AH0605	160271	1417413000	080109	2910001116	191586	2916690004	190579
0986AH0613	160216	1417413047	080111	2910001118	191770	2916690005	190580
0986AH0614	160216	1450522000	090073	2910001189	190552	2916691007	190582
0986AH0615	160337	1455523028	090166	2910002158	192065	2916693007	190582
0986AH0617	160216	1457413010	080250	2910011157	190546	2916699081	190578
0986AH0622	160316	1457413012	080108	2910011158	192065	2916699082	190579
0986AH0625	160081	1457413013	080108	2910012118	191770	2916699083	190580
0986JG1563	150663	1457434000	090076	2910012126	190538	2916699085	190582
1000300004	191304	1457434201	AS301	2910012130	190539	2916699086	190583
1003300005	191304	1457434900	AS301	2910012132	190540	2916710602	080696
1003410115	191585	1460015300	080099	2910012150	191320	2916710604	190826
1003421000	191763	1460210008	080420	2910012154	190545	2918740004	190579
1003421002	191763	1460283302	080097	2910012164	191557	2918740005	190580
1003429002	191326	1460283307	080097	2910012191	190552	2918740007	190582
1003429004	191770	1460283311	080097	2910021128	B191329	2918740008	190583
1003429006	191770	1460324315	080161	2910021150	191319	2918750111	190579
1003429008	190536	1460324316	080162	2910021157	190546	2918750112	190580
1003429009	191326	1460324331	080163	2910022118	191586	2918750132	190593
1003450008	190474	1460324332	080164	2910022170	190550	2918750134	190584
1003450010	191585	1460324333	080165	2910022196	190555	3334485007	190767
1003450013	191585	1460324337	080232	2910022201	190555	3334485008	193600
1003450040	191584	1461015300	080099	2910042138	190542	3337213001	080177
1003450047	191584	1463162104	080828	2910641154	192145	3397011425	160329
1003450048	191585	1463456303	080114	2911011213	191854	3397013448	161061
1003450049	191585	1467010059LD	090092	2911051237	190492	3397013449	161063
1004450013	191585	1467010467	090165	2911051281	192752	3397013450	161064
1120150008	191913	1480210016	081129	2911061301	190510	3397013453	161067
1123300020	191898	1680750014	090255	2911121152	190545	3397013462	161062
1123300500	191303	1680750015	090257	2911201701	080252	3397018140	160321
1123314008	191307	1901321209	191016	2911201702	080254	3397018145	160322
1123410076	191582	1928403577	081040	2911202703	080255	3397018170	160328
1123421002	191643	1928498061	192998	2911421158	190546	3397018170	160411
1123421008	191533	1928498300	081040	2911432156	191900	3397018191	161013
1123429133	191582	2000210042	191350	2912452152	190544	3397018199	160330
1123429202	191528	2000500089	190590	2912452191	190552	3397018963	160327
1123429203	191585	2000550003	191337	2912772152	190545	3397018963	160370
1123429206	191873	2003300015	190782	2914502010	191329	3397018966	160325
1123429207	191584	2003315012	191308	2915010007	190780	3397018966	160326
1123429211	191582	2003412001	190545	2915010405	190521	6033GC8223	191657
1123429214	191899	2003450040	190510	2915010406	190779	61311373588	160083
1123429216	191528	2004477014	191047	2915010407	190780	9001140234	192347
1123429231	191584	210843	210843	2915010409	191304	9001333411	191770
1123429233	191582	210909	210909	2915010410	190783	9001333451	191321
1123433001	191318	2123315000	190780	2915011007	190780	9005140254	191048
1123433005	191478	221604037	150912	2915011010	191305	9121333305	191645
1123433007	191330	2247222000	080840	2915011039	191305	9187451002	160734
1123433032	191478	2417010001	090027	2915012006	190779	9220081505	150891
1123433033	191478	2417413013	080690	2915012007	190780	9222067034	150377
1124477075	190283	2417413060	080250	2915039028	191657	9401240170	090062
1137101025	150057	2430105009	080691	2915050408	191305	9431610005	080424
1190100029	191290	2430105020	080692	2915051106	191303	9431610156	080389
1194485404	190762	2430105032	080777	2915051107	191304	9431610274	080688
1227000034	150056	2430105044	080777	2915051108	190783	9431610276	080736
1227010001	150056	2430105046	080427	2915051119	191439	9431610282	080734
1227010002	150055	2430136015	080340	2915052107	191304	9431610360	080388
1227010003	150098	2430136202	080340	2915059106	191303	9431610604	080689
1227010004	150056	2430190002	080388	2915059107	191304	9440030003	090016
1227010005	150098	2430223003	081129	2915059108	191305	9491143302	080242
1227010006	150098	2430501004	080732	2915059180	191304	9491143304	080240
1227010008	150055	2430501006	080397	2915061005	190527	9491337029	191657
1227010039	150098	2430501009	080732	2916011007	191303	9580810046	070053
1227022008	150056	2430501011	080736	2916011012	190589	AE34	161061
1227022017	150057	2433314182	081004	2916011013	191290	AE38	161062
1227022018	150057	2433456020	080575	2916012012	191506	AE40	161063
1227022031	150057	2433456034	080575	2916012014	190598	AE45	161064
1227622018	150057	2440365006	081003	2916012020	190594	AE48	161065
1237010028	150057	2443456007	080255	2916022013	190599	AE50	161066
1237010029	150057	2447010011	080064	2916022014	191579	AE53	161067
1237010031	150057	2447010016	080294	2916060008	191337	AE55	161068
1237010038	150057	2447010020	080840	2916060013	190582	AE60	161069
1305320818	170621	2447010033	080742	2916062008	191337	AE65	161070
1333412001	190478	2447010038	080742	2916063008	191337	AE70	161071
1333450021	190478	2447010045	080695	2916063013	190582	DN0SD265	100352
135061	135061	2447222023	080295	2916069081	190588	F000ZS0103	150246
1410501072	080390	2447222125	080742	2916069084	191337	F000ZS0116	150270
1417010997	090441	2447222126	080742	2916069086	190583	F000ZS0121	150266
1417010998	090441	2459999002	080292	2916069091	190582	F000ZS0211	150572
1417010999	090441	2467010002	090212	2916069161	191337	F000ZS0212	150416

OE No.	HC-CARGO	OE No.	HC-CARGO	OE No.	HC-CARGO	OE No.	HC-CARGO
FO02G91122	192586	FO0HL00220	181590	FP/KE22AD246/2	090202	CAV	
FO0HL00010	181589	FO0HL00221	181590	FP/KE22AD247/2	090015	1854040	100177
FO0HL00014	181589	FO0HL00222	181590	FP/KE22AD247/2H	090015	5001-10	190580
FO0HL00030	181584	FO0HL00224	181589	FP/KE22AD249/2	090202	5001-26	190583
FO0HL00031	181584	FO0HL00225	181589	FP/KE22AD252/2	090015	5001-31	190582
FO0HL00034	181590	FO0HL00226	181590	FP/KE22AD252/4	090015	5001-43	190584
FO0HL00035	181584	FO0HL00227	181589	FP/KE22AD265/2	090202	5001-48	190580
FO0HL00036	181590	FO0HL00230	181590	FP/KE22AD278/2	090015	5001-53	190582
FO0HL00037	181584	FO0HL00233	181585	FP/KE22AD279/2	090015	5001-74	190582
FO0HL00038	181585	FO0HL00234	181589	FP/KE22AD281/2H	090015	5244-22	190579
FO0HL00042	181590	FO0HL00235	181590	FP/KE22AD283/2	090202	5334-476	192145
FO0HL00043	181590	FO0HL00236	181590	FP/KE22AD285/2	090015	5335-960	191321
FO0HL00050	181590	FO0HL00237	181589	FP/KE22AD286/2	090202	5335-963C	192592
FO0HL00052	181590	FO0HL00238	181589	FP/KE22AD288/2	090202	5335-963E	192591
FO0HL00054	181590	FO0HL00239	181590	FP/KE22AD293/4	090015	5339-401	080296
FO0HL00060	181590	FO0HL00240	181590	FP/KE22AD294/2	090202	5339-423	080430
FO0HL00061	181590	FO0HL00246	181590	FP/KE22AD297/2	090202	5339-970	080031
FO0HL00063	181590	FO0HL00248	181590	FP/KE22AD301/2	090202	5836B320	090194
FO0HL00065	181590	FO0HL00254	181590	FP/KE22AD305	090015	5855-30	080194
FO0HL00083	181585	FO0HL00255	181590	FP/KS22AD15	090016	5864-002	090145
FO0HL00085	181590	FO0HL00257	181590	FP/KS22AD15/3	090016	5864-003	090146
FO0HL00086	181590	FO0HL00267	181590	FP/KS22AD16	090016	5886-200C	191276
FO0HL00088	181590	FO0HL00271	181590	FP/KS22AD25/4	090016	5936-102	190582
FO0HL00103	181588	FO0HL00303	181590	FP/KS22AD26/4	090016	5936-482C	191290
FO0HL00108	181589	FO0HL00305	181588	FP/KS22AD27/2	090016	5936-482D	191502
FO0HL00109	181590	FO0HL00309	181590	FP/KS22AD31/2	090016	5936-487	190577
FO0HL00111	181590	FO0HL00311	181584	FP/KS22AD36/2	090016	5936-495M	190593
FO0HL00118	181590	FO0M390002	190367	FP/KS22AD41/2	090016	5936-495N	190594
FO0HL00120	181589	FO0M390005	192586	FP/KS22AD46/2	090016	6010-177	191308
FO0HL00123	181589	FO0M390009	192569	FP/KS22AD53/4	090016	6211-168	191274
FO0HL00126	181589	FO0M390013	191528	FP/KS22AD6	090016	6223-001	080071
FO0HL00127	181584	FO0M990011	191318	FP/KS22AD6/2	090016	6223-004	090159
FO0HL00128	181589	FO0M990012	191657	FP/KS22AD6/3	090016	7097-81M	080809
FO0HL00129	181590	FO0M990014	191304	FP/KS22AD6/4	090016	7111-296	AS301
FO0HL00135	181590	FO0M990053	191533	HB9440030004	090202	7111-353	090320
FO0HL00137	181589	FO0M990062	191478	HB9440030010	090202	7111-353AS	090071
FO0HL00139	181590	FO0M990102	B230731	HB9440030013	090202	7111-353AZ	090404
FO0HL00141	181588	FO0M990104	191304	HB9440030014	090202	7111-353BH	090345
FO0HL00147	181588	FO0M990127	191513	HB9440030016	090202	7111-353BR	090346
FO0HL00151	181590	FO0M990127	B191513	IC16128	150623	7111-353BV	090072
FO0HL00152	181590	FO0M990136	191318	BUTEC		7111-403	090074
FO0HL00153	181590	FO0M990139	191318	854322	190561	7111-429	090073
FO0HL00154	181590	FO0M990150	191308	858639	190478	7111-439	080465
FO0HL00155	181590	FO0M990151	191318	858649	191586	7111-843	080701
FO0HL00156	181590	FO0M990164	191318	858650	191770	7111-853	080702
FO0HL00157	181590	FO0M990165	191326	CARTIER		7123-19	080773
FO0HL00158	181590	FO0M990166	191267	02386	160423	7123-287	080205
FO0HL00161	181590	FO0M990175	192569	02388	160423	7123-351A	080038
FO0HL00162	181585	FO0M990178	191304	02389	160424	7123-351B	080038
FO0HL00163	181585	FO0M990180	191318	02393	160425	7123-388	080614
FO0HL00165	181590	FO0M990181	191513	02394	160424	7123-770	080188
FO0HL00166	181590	FO0M990181	B191513	02396	160438	7135-104	081007
FO0HL00167	181590	FO0M990184	192586	02474	160354	7135-110	090047
FO0HL00168	181590	FO0M990188	192586	CASE		7135-124	090055
FO0HL00174	181590	FO0M990191	191657	07074850	160216	7167-620A	080595
FO0HL00176	181590	FO0M990195	192586	07077033	160919	7167-620B	080207
FO0HL00178	181590	FO0RJ01086	081173	139026A2	160081	7167-620C	080212
FO0HL00179	181590	FO0VC17503	081115	1964535C2	160263	7167-620D	080212
FO0HL00180	181590	FO0VC17504	081209	198161A1	160337	7169-519A	080739
FO0HL00181	181590	F01G29R006	090440	198162A1	160216	7174-496	080933
FO0HL00182	181590	FP/K22P22	090020	1987420C2	160081	7180-451	080205
FO0HL00183	181590	FP/K22P31	090020	1987452C1	160311	7180-49A	080211
FO0HL00184	181590	FP/K22P36	090020	3136900	172088	7180-49B	080211
FO0HL00185	181590	FP/K22P39	090020	3136910	172088	7180-49C	080210
FO0HL00186	181590	FP/K22P48	090020	4120472	160366	7180-49D	080210
FO0HL00187	181590	FP/K22P60	090020	82856475	160403	7180-49D	080210
FO0HL00191	181590	FP/K22P77	090020	904374	090156	7182-580A	080757
FO0HL00192	181590	FP/K22P9	090020	98042459	170936	7182-580G	080995
FO0HL00196	181584	FP/KE22AD112/2	090202	CATERPILLAR		7185-900H	080996
FO0HL00198	181590	FP/KE22AD174/2	090015	4RD00352009	160337	7185-900K	080211
FO0HL00199	181590	FP/KE22AD174/4	090015	4RD003520-09	160216	7185-900P	080210
FO0HL00202	181589	FP/KE22AD190/2	090202			7185-900T	080212
FO0HL00205	181585	FP/KE22AD202/2	090202			7185-900W	080595
FO0HL00206	181585	FP/KE22AD207/2	090015			7240-20B	080038
FO0HL00207	181590	FP/KE22AD207/4	090015			9001-088	080703
FO0HL00208	181590	FP/KE22AD223/2	090015			9001-142	090381
FO0HL00217	181590	FP/KE22AD223/4	090015			9001-742A	090316
FO0HL00218	181590	FP/KE22AD240/2	090015			9001-742B	090316
FO0HL00219	181590	FP/KE22AD244/2	090015			9001-742G	090316
						9007-497L	080738

ACCESSORIES

O.E.M. names and numbers are used for reference purposes only.

OE No.	HC-CARGO	OE No.	HC-CARGO	OE No.	HC-CARGO	OE No.	HC-CARGO
56041702AA	181590	MD165083	181591	E116	150068	511756	090020
56041706AA	181590	MD181 398	181591	E14	150056	608264	090015
56041731AA	181591	MD181398	181591	E15	150055	86751	160337
56041732AA	181591	MD182 691	181590	E17	150062	867512	160240
56041845AA	181590	MD182 793	181590	E18	150058	867515	160337
56041846AA	181590	MD183 145	181591	E19	150072	CBU1099	090156
56041847AA	181590	MD183 399	181591				
56041848AA	181590	MD183145	181591	CUMMINS		DAIHATSU	
56041887AA	181590	MD183399	181591	3164098	192902	19070B1020	150893
56041941AA	181591	MD184 939	181591	3281381	080696	19070-B1020	150893
56041942AA	181591	MD184939	181591	3352550	090015	19500B2040	150614
56041950AA	181590	MD185 334	181591	3904374	090156	19850-64010-000	100257
56041951AA	181590	MD185 335	181590	3906659	080691	19850-87701-000	100257
56041952AA	181590	MD185334	181591	3918076	090251	19850-87702-000	100283
56041953AA	181590	MD186 392	181591	3928143	090156	19850-97309-000	100256
56044215AA	181590	MD186 991	181590	3928144	090250	8350000000000	150764
56044580AA	181591	MD186 992	181591	3931195	090107	8350000000000	150768
56044581AA	181591	MD186392	181591	3936316	090391	8350000000000	150783
56044582AA	181591	MD186990	181591	4893741	081115	8350000000000	150794
56044583AA	181591	MD186992	181591	93151910	090251	8350000000000	150798
8933000598	181584	MD188208	181590	DW803	090251	83530-12040-000	150798
8933002455	181584	MD189 007	181591			83530-14030	150768
96 253 547	181591	MD189007	181591	DAEWOO		83530-14030	150777
96 291 086	181591	MD192 071	181591	01115467	150621	83530-14030	150783
96 291 099	181591	MD192 072	181591	03439088	180808	83530-14030	150798
96 333 009	181591	MD192 091	181591	1115467	150621	83530-14030-000	180641
96 394 003	181591	MD192071	181591	33410A78B00	150909	83530-14050	150768
96 394 004	181591	MD192072	181591	380017	150619	8353087102	150768
96 423 429	181591	MD192091	181591	90245033	181182	8353087102	150794
96253547	181591	MD302 068	181591	90336039	150762	8353087103	150764
96291086	181591	MD302068	181591	92927023	070053	8353087702	150764
96291099	181591	MD305 144	181590	95961350	150762	8353087702	150768
96333009	181591	MD305 145	181591	96165049	150621	8353087702	150783
96394003	181591	MD305 147	181591	96192077	181182	8353087702	150794
96394004	181591	MD305 149	181591	96281689	150762	8353087702	150798
96423429	181591	MD305145	181591	96350585	150619	83530-87705	150768
M05269711	181590	MD305147	181591	96453420	150910	83530-87705	150777
MD003824	150395	MD305149	181591	96494264	150762	83530-87705	150783
MD011 25	181584	MD307 258	181590	96647339	150762	83530-87705	150798
MD011225	181584	MD311230	181590			83530-87705	180641
MD01125	181584	MD313 819	181591	DAF		83530-87705-000	180641
MD073036	181584	MD313819	181591	0067378	160216	89465-14120	181591
MD073175	181584	MD335 051	181591	0118159	160216	89465-87101	181584
MD073461	181584	MD335051	181591	0515912	160317	89465-87101-000	181584
MD073546	181584	MD345 230	181591	0621969	180399	89465-87102	181584
MD076706	181584	MD345230	181591	067378	160216	89465-87102-000	181584
MD077621	181584	MD354 850	181590	086751	160216	89465-87103-000	181584
MD088616	181584	MD354 851	181590	0867514	160215	89465-87105	181584
MD089922	181584	MD370045	181590	0867515	160337	89465-87105-000	181584
MD107793	181584	MD607478	150068	0867517	160216	89465-87106	181584
MD108934	181584	MD607814	150096	0867518	160216	89465-87106-000	181584
MD110487	181584	MD611384	150096	0907335	160216	89465-87108	181584
MD110492	181584	MN158 757	181590	1226138	190766	89465-87108-000	181584
MD112479	150377	MN158 758	181590	1272653	170968	89465-87109	181584
MD117240	181584	MN158 759	181591	1279539	160265	89465-87109-000	181584
MD119210	181584	MN158759	181591	1353958	100511	89465-87201-000	181584
MD119609	181584	MR507 385	181590	1391484	192902	89465-87202	181584
MD121306	181584	MR507 386	181590	1403871	160216	89465-87202-000	181584
MD127062	181584	MR507 387	181591	1427048	171171	89465-87209-000	181584
MD128262	181584	MR507387	181591	1435116	170936	89465-87209-000	181584
MD131446	181584	MR560 365	181591	1444658	171230	89465-87210	181584
MD131447	181584	MR560364	181590	1457437	160769	89465-87210-000	181584
MD135140	181584	MR560365	181591	1519523	160337	89465-87211	181584
MD136 491	181590	T0701130	100511	1523983	160337	89465-87211-000	181584
MD136308	181590	T0771828	150802	1526349	160266	89465-87212	181584
MD136309	181584	T1348032	150796	1527015	160215	89465-87212-000	181584
MD136310	181590	T1348032	150809	1600335	192586	89465-87601	181584
MD136493	181590			160394	160394	89465-87601-000	181584
MD137 224	181584	CLAAS		165802	090015	89465-87704	181584
MD137224	181584	0007440700	160316	1669972	161035	89465-87704-000	181584
MD137274	181584	6854030	170936	1778563	160265	89465-97203	181584
MD140388	181584	7440700	160316	1880377	160769	89465-97203-000	181584
MD143 490	181591	7440710	160316	229367	090020	89465-97207	181591
MD143490	181591			245339	090202	89465-97211	181590
MD143490	181591	CITROËN → PEUGEOT		248252	090015	89465-97211-000	181590
MD148687	181584	COMMERCIAL IGNITION		265401	160317	89465-97212-000	181590
MD149813	181584	EI11	150067	273077	080692	89465-97216	181590
MD164 422	181591	EI14	150057	316447	150395	89465-97216-000	181590
MD164422	181591					89465-97217	181590

ACCESSORIES

O. E. M. names and numbers are used for reference purposes only.

OE No.	HC-CARGO	OE No.	HC-CARGO	OE No.	HC-CARGO	OE No.	HC-CARGO
DAIHATSU continued							
89465-97217-000	181590	CE2001912B1	150428	GN1025612B1	150557	HDS397	100595
89465-97218-000	181591	CE20029	150616	GN10257	150899	HDS400	100657
89465-97221	181591	CE20029	150620	GN1025712B1	150899	HDS404	100622
89465-97221-000	181591	CE2002912B1	150616	GN10303	150642	HDS406	100674
89465-97403	181591	CE2002912B1	150620	GN1030312B1	150642	HDS408	100675
89465-97403-000	181591	CE20030	150509	GN10311	150655	HDS415	100641
89465-97405	181591	CE2003012B1	150509	GN1031112B1	150655	HDS416	100663
89465-97504	181591	CE20034	150656	GN10312	150663	HDS420	100651
89465-97508	181591	CE2003412B1	150656	GN1031212B1	150663	HDS423	100652
89465-97509	181591	CE20038	150424	GN10313	150617	LH0320	150809
89465-B2100	181591	CE2003812B1	150424	GN1031312B1	150617	LH3642	150809
9000000000000	150395	CE20042	150416	GN10315	150662	SS10811	150470
9004052012000	150917	CE2004212B1	150416	GN1031512B1	150662	SS10941	150354
90048-52003	150395	CE20043	150637	GN10317	150582	SW90000	150805
90048-52010	150395	CE2004312B1	150637	GN1031712B1	150582	SW90017	150769
90048-52022	150395	CE20044	150416	GN10318	150605	SW90024	150760
90048-52026	150395	CE2004412B1	150416	GN10318	150631	SW90025	150779
90048-52028	150395	CE20047	150434	GN1031812B1	150605	TSP0545019	261349
90048-52029	150395	CE2004712B1	150434	GN1031812B1	150631	TSP0545029	261310
90048-52030	150395	CE20048	150433	GN10319	150520	TSP0545029	261311
90048-52032	150395	CE2004812B1	150433	GN1031912B1	150520	WC10026	150805
90048-52034	150395	CE20053	150891	GN10324	150615	DENSO	
90048-52038	150395	CE2005312B1	150891	GN10327	150898	028903-5040	191546
90048-52039	150395	CE20056	150609	GN1032712B1	150898	0297001290	150917
90048-52044	150395	CE2005612B1	150609	GN10336	150648	0297003075	150917
90048-52045	150395	CE20058	150246	GN1033612B1	150648	0297003263	150917
90048-52049	150395	CE2005812B1	150246	GN10337	150613	0297004241	150917
90048-52050	150395	CE20062	150903	GN1033712B1	150613	0297004410	150917
90048-52051	150395	CE2006212B1	150903	GN10341	150647	0297004691	150917
90048-52054	150395	CE2009	150650	GN1034112B1	150647	0297004800	150917
DELPHI							
0014603	180340	CE200912B1	150650	GN10345	150508	0297040060	150917
0014610	180341	DS093A	100548	GN10356	150894	056700-4810	160480
0014644	180339	DS094A	100548	GN1035612B1	150894	067100-1161	100280
0051734	192686	DS10000	150403	GN1037012B1	150904	067100-1170	100256
10808186	160282	DS1000012B1	150403	GN10375	150640	067100-1171	100256
113302	180287	DS20013	150619	GN1037512B1	150640	067100-1175	100256
134711	191205	DS2001312B1	150619	GN10382	150639	067100-1177	100256
134712	191206	DS2001312B1	150619	GN1038212B1	150639	067100-1270	100260
150300	192685	ES2012811B1	181590	GN10383	150641	067100-1340	100282
200140	180215	GN10018	150435	GN1038312B1	150641	067100-1350	100256
206500	180529	GN1001811B1	150435	GN10401	150649	067100-1360	100280
250940	180156	GN10024	150901	GN1040112B1	150649	067100-1370	100258
253002	180314	GN1002411B1	150901	GN10413	150900	067100-1430	100257
259000	180158	GN10068	150270	GN1041312B1	150900	067100-1500	100277
259991	180159	GN1006811B1	150270	GN10415	150660	067100-1530	100257
290125	180229	GN10168	150673	GN1041512B1	150660	067100-1591	100657
300403	180045	GN1016811B1	150673	GN10418	150907	067100-1630	100260
300711	180324	GN10171	150885	GN1041812B1	150907	067100-1690	100283
327052	180025	GN1017112B1	150885	GN10422	150671	067100-1710	100291
327352	180043	GN10173	150266	GN1042212B1	150671	067100-1840	100516
327432	181518	GN1017311B1	150266	GN10440112B1	150649	067100-1860	100514
327452	180027	GN10191	150890	GN10443	150635	071800-0320	180641
327499	181597	GN10195	150513	GN1044312B1	150635	071800-0410	180641
328062	180041	GN1019512B1	150513	GN10446	150657	071800-0620	180641
330262	180044	GN10198	150525	GN1044612B1	150657	081135-0020	190815
330290	181595	GN1019812B1	150525	GN10450	150658	081135-0030	190820
330291	181596	GN10205	150558	GN1045012B1	150658	093245-0140	080457
854000	170137	GN1020512B1	150558	GN1045112B1	150625	093245-0150	080457
854600	170596	GN10206	150636	GN10481	150621	096010-0500	080680
CE10000	150521	GN1020612B1	150636	GN1048112B1	150621	096030-0070	080177
CE1000012B1	150521	GN10207	150633	GN10493	150908	096030-0080	080178
CE10001	150884	GN1020712B1	150633	GN1049312B1	150908	096030-0170	080178
CE1000112B1	150884	GN10211	150252	GN10547	150622	128950-0400	191546
CE10023	150227	GN1021112B1	150252	GN1054712B1	150622	128960-0040	191546
CE1002312B1	150227	GN10212	150668	GN10568	150672	131300-0033	150157
CE10106	150395	GN1021212B1	150668	GN1056812B1	150672	131300-0072	150157
CE20010	150634	GN10219	150661	GN10570	150606	131300-0073	150157
CE2001012B1	150634	GN1021912B1	150661	GN1057012B1	150606	131300-0330	150157
CE20011	150522	GN10234	150652	GN1057112B1	150608	131300-0341	150157
CE2001112B1	150522	GN1023412B1	150652	GN1057212B1	150608	131300-0600	150157
CE20014	150505	GN10236	150508	GN1058312B1	150618	131300-0601	150157
CE2001412B1	150505	GN1023612B1	150508	GN1058512B1	150889	131301-0601	150157
CE20017	150441	GN10241	150623	HDS248	100433	142000-0200	100429
CE2001712B1	150441	GN1024111B1	150623	HDS303	100307	146600-4620	090212
CE20018	150624	GN10248	150628	HDS309	100548	191375	191375
CE2001812B1	150624	GN1024811B1	150628	HDS310	100616	191530	191530
CE20019	150428	GN10249	150644	HDS369	100335	210843	210843
		GN1024911B1	150644	HDS380	100639	210948	210948
		GN10256	150557	HDS391	100670	297000651	150395

OE No.	HC-CARGO	OE No.	HC-CARGO	OE No.	HC-CARGO	OE No.	HC-CARGO
297002143	150395	DEUTSCH		01178933	180634	ELPRESS	
31974-44000	090347	0413-204-2005	192788	1175862ES8239-70	190766	A1504FL5	190045
90170-10061	191305	0460-202-16141	192505	1178933	180634	A1504HA	190021
901900-8651	191513	0460-202-20141	192619	6263052	190766	A1504HO	190017
90190-08651	191513	0460-204-11817	192621	CC6262010	171171	A1507FL	190022
902580-6001	190580	0460-215-16141	192477			A1507FLF	190985
90258-06001	190580	0462-201-16141	192506	DOGA		A1507FLH	190025
90258-14001	191288	0462-201-20141	192620	111.3756.2B.00	160503	A1507H	190019
90557-15000	191270	0462-203-12141	192622	111.3756.3B.00	160504	A1519SR	190974
91050-05081	191545	0462-209-16141	192478	111.9001.2B.00	160395	A1525SK	190028
91310-04121	190536	112263-90	192683	112.1340.2B.04	160558	A1532G	191501
91310-04251	191478	DT04-08PA	192466	112.1380.2B.00	160031	A1532R	190038
91418-05141	192145	DT04-12	192451	112.1380.3B.00	160032	A1537R	190027
948007-0010	192065	DT04-2P	192458	112.1540.2B.00	160506	A1543G	190973
949006-1830	190558	DT04-3P	192460	112.1580.3B.00	160034	A1553R	190031
949006-4880	190558	DT04-4P	192462	113.2550.2B.00	160292	A1565R	190015
949006-5020	190539	DT04-6P	192464	113.2550.3B.00	160293	A2505HA	190023
949006-5080	191531	DT06-12SA	192450	113.5440.2B.00	160357	A2505HO	190018
949006-5460	191586	DT06-2P	192457	113.5623.2B.10	160290	A2507FL	190020
949006-5470	191586	DT06-3S	192459	113.5623.3B.10	160291	A2507FLF	190046
949006-6401	191319	DT06-4S	192461	116.5365.2B.IE	160659	A2507FLH	190026
949006-6690	190558	DT06-6S	192463	116.5404.2B.D0	160725	A2507H	190016
949006-6970	190538	DT06-8S	192465	116.5565.2B.D0	160258	A2508FL	190041
949007-1241	191558	DTM04-12PA	192606	116.5565.3B.D0	160408	A2519SR	190952
949007-1810	190536	DTM04-2P	192596	121.0901.GA.I6	160484	A2527SK	190001
949007-1970	190558	DTM04-3P	192598	127.0907.GA.04	160571	A2532R	190257
949007-2590	190537	DTM04-4P	192600	128.1204.00.04	161021	A2537R	190029
949007-2850	191586	DTM04-6P	192602	13650070706	160727	A2543C	191067
949007-3120	191329	DTM04-8PA	192604	162.4102.2B.00	160005	A2553G	190037
949007-3370	191586	DTM06-12SA	192605	162.4102.3B.00	160006	A2553R	190032
949007-3660	191327	DTM06-2S	192595	316.5369.30.14	161023	A2565R	190034
949007-3930	191586	DTM06-3S	192597	316.5565.3B.D0	160408	A2585R	190039
949007-4100	191554	DTM06-4S	192599	319.0724.30.00	161022	A4605HA	190051
949007-4110	190538	DTM06-6S	192601	319.1063.30.10	161025	A4605HO	190050
949007-6280	191586	DTM06-8SA	192603	319.1724.30.00	161024	A4607FL	190024
949007-6530	191660	DTP04-2P	193017	P100	160330	A4607H	191191
949007-6850	191545	DTP04-4P	193019	P40	160321	A4609FL	190048
949007-7450	191327	DTP06-2S	193018	P45	160322	A4610R	190042
949010-2000	191350	DTP06-4S	193020	P50.1	160323	A4613R	191515
949015-0720	191288	HDP24-24-23-SE	192652	P60	160325	A4630SR	190953
949042-1840	191585	HDP24-24-31-SE	192656	P60.1	160326	A4652SK	190030
949042-2960	191528	HDP24-24-9PN	193045	P60.3	160326	A4653R	190033
949042-3950	191539	HDP26-24-23-PE	192651	P60.4	160326	A4665R	190035
949044-4270	190474	HDP26-24-31-PE	192655	P65	160327	A4685R	190255
949046-2040	191293	HDP26-24-9SN	193044	P65.1	160327	B0457H4	191016
949047-1961	190479	W12P	192453	P65.2	160370	B0457H5	190283
949047-2130	191546	W12S	192452	P70	160328	B0907H5	191047
949047-3410	190474	W2P	192468	P70.2	160411	B2507H	191415
949047-3560	191293	W2S	192467	P702	160411	B409FL	190868
949047-4440	191545	W3P	192470	P80	160329	B409H	191549
949047-5010	190549	W3S	192469	P90.1	161013	B410FL	190252
949047-5440	191326	W4P	192472			B410H	190270
949047-7870	191545	W4S	192471	DUCELLIER		B411FL	191029
949050-1080	192228	W6P	192474	245510	150055	B411H	191028
949050-3340	191657	W6S	192473	2526037A	150259		
949056-0750	191308	W8P	192476	2526040A	150259	FACET	
949056-0990	191307	W8S	192475	254410	150055	1800056	150810
949056-1001	191308	WM12P	192618	2790	150395	1800134	150773
949056-1130	191308	WM12S	192617	3801	150395	1800138	150799
949056-1370	191513	WM2P	192608	520004	150395	1800177	150797
949056-2360	191513	WM2S	192607	521007	150055	40107	070191
949056-2480	191307	WM3P	192610	521008	150055	40159E	070058
949056-2481	191307	WM3S	192609	521013	150055	40164	070056
949056-2520	191298	WM4P	192612			40185	070057
949056-2750	191657	WM4S	192611	DURACELL		40220	070134
949056-3080	191308	WM6P	192614	D357	200779	476087E	070003
949056-3300	191513	WM6S	192613	MN11	200776	476088	070004
949056-3460	191513	WM8P	192616	MN27	200777	476088E	070004
949056-4480	191305	WM8S	192615	PX625A	200778	500056	150810
949056-4910	191307	WP2P	193021			500134	150773
949180-0490	080001	WP2S	193022	EFEL		500138	150799
99700048	150658	WP4P	193023	04117	190510	500177	150797
DG-108	100657	WP4S	193024			50107	070191
DG-174	100670			ELETTROSTART		60104	070187
DG-176	100675	DEUTZ-FAHR		ES612AM3TG	090318	60106	070188
DG180	100663	01101600	180399	ES622AM3TG	090317	60107	070191
DIC0107	150658	01163922	160316			7.0001	180631
		01163952	160654			7.0006	150796
		01175862	190766			7.0007	180634

ACCESSORIES

O.E.M. names and numbers are used for reference purposes only.

OE No.	HC-CARGO	OE No.	HC-CARGO	OE No.	HC-CARGO	OE No.	HC-CARGO
FACTET continued							
7.0008	180635	7.6073	181182	9.6216	150424	12630	150807
7.0010	180634	7.6075	181183	9.6254	150428	12635	150792
7.0011	180636	7.6096	181191	9.6277	150433	12636	150791
7.0014	150815	7.6099	181194	9.6278	150434	12650	150803
7.0017	180641	7.6102	181197	9.6279	150416	12841	150797
7.0026	180648	7.6108	181201	9.6279S	150416	12880	150779
7.0027	180649	7.6125	181212	9.6280S	150416	12881	150760
7.0028	180649	7.6215	181456	9.6281	150435	12882	150773
7.0045	180658	70015	150770	9.6295	150416	12890	150769
7.0046	150789	70016	150794	9.6319	150441	1290	150789
7.0047	180660	70069	150762	9.8034	150403	12900	150789
7.0056	150784	70071	150761	9.8114	150227	1291	180658
7.0056	150810	70075	150802	9.8120	150435	1293	180688
7.0095	180688	70076	150775	96079	150914	12970	150799
7.0096	150759	70139	150760	96121	150901	1342	180649
7.0096	150805	70144	150803	96128	150891	1352	180636
7.0108	180694	70145	150801	96247	150885	2101	180790
7.0110	150804	70148	150813	96254S	150428	2102	180791
7.0124	150795	70151	150791	96303	150634	2108	180791
7.0131	150807	70153	150792	96305	150522	2401	180726
7.0132	150769	70163	150806	96317	150557	2402	180734
7.0135	150779	70166	150780	96326	150656	2407	180731
7.0138	150799	70168	150811	96329	150508	2415	180734
7.0141	150766	70170	150787	96331	150513	2444	180785
7.1000	180726	70174	150760	96332	150505	3114	180804
7.1005	180009	70177	150797	96334	150635	3211	180839
7.1007	180731	70178	150763	96336	150636	3223	180808
7.1014	180734	70179	150781	96342	150609	3301	180875
7.1091	180785	70180	150790	96357	150673	3306	180905
7.1101	180790	70181	150778	96359	150663	3326	180893
7.1102	180791	70182	150776	96375	150574	3362	180848
7.1149	181367	70183	150767	96375	150608	3363	180861
7.1151	181369	70187	150782	96405	150629	3364	180883
7.2004	180790	70188	150808	96407	150640	3507	180945
7.2005	180791	70189	150788	96416	150610	3513	180950
7.3000	180804	70190	150814	96432	150416	3517	180953
7.3005	180808	70192	150800	96452	150623	3537	180953
7.3018	180839	70195	150765	96479	150665	3538	180954
7.3028	180820	70196	150771	96480	150667	3549	180986
7.3073	180839	70199	150793	96482	150607	3550(2)	180985
7.3086	180848	9.0016	150340	96483	150892	3552	180949
7.3101	180861	9.0053	150354	96484	150670	3578	180959
7.3128	180875	9.0169	150451	98118	150619	3580	180959
7.3146	180883	9.0195	150414	Q-40106	070188	3605	181077
7.3165	180893	9.0196	150404			3701	181001
7.3191	180905	9.0235	150468	FAE		3704	181008
7.3239	181395	9.0241	150470	1061	150815	3705	181005
7.3257	181400	9.0254	150470	10610	150815	3708	181005
7.3258	181400	9.0371	150496	1106	180634	3712	181009
7.3308	181373	9.0543K	150404	1107	180635	3718	181005
7.4000	180945	9.4001	150058	1120	180631	3722	181021
7.4007	180949	9.4002	150062	1138	180649	3725	181064
7.4014	180950	9.4003	150064	1140	180631	3731	181001
7.4029	180953	9.4005	150055	1146	180631	3734	181008
7.4030	180954	9.4006	150057	1161	180641	3735	181005
7.4042	180959	9.4007	150075	1169	180694	3738	181005
7.4079	180985	9.4009	150072	1222	180636	3739	181005
7.4080	180986	9.4012	150067	1223	150770	3742	181009
7.5000	181001	9.4015	150068	12230	150770	3767	181064
7.5004	181005	9.4020	150088	1224	150794	3795	181121
7.5007	181008	9.4025	150063	12240	150794	4029	181147
7.5008	181009	9.4027	150068	1235	150775	4030	181148
7.5018	181015	9.4028	150057	12350	150775	4038	181150
7.5031	181021	9.4030	150165	1237	150775	4051	181182
7.5064	181034	9.4031	150154	12370	150775	4057	181194
7.5128	181064	9.4036	150175	1238	150802	4060	181191
7.5142	181073	9.4038	150157	12380	150802	4065	181201
7.5145	181076	9.4044	150234	12390	150810	4066	181212
7.5146	181077	9.4052	150236	1241	150761	4107	181156
7.5155	181034	9.4068	150160	12410	150761	4112	181197
7.5182	181088	9.4070	150377	1243	150762	4212	181183
7.5187	181089	9.4076	150406	12430	150762	79005	150354
7.5626	181121	9.6008	150612	12436	150766	79060	150451
7.5635	181126	9.6046	150246	12438	150787	80208	150522
7.6007	181147	9.6068	150252	1249	150804	80247	150574
7.6009	181148	9.6088	150259	12490	150804		
7.6011	181150	9.6098	150266	1252	150804		
7.6019	181156	9.6114	150270	12520	150804		
7.6021	181158	9.6172	150668	12610	150801		

OE No.	HC-CARGO	OE No.	HC-CARGO	OE No.	HC-CARGO	OE No.	HC-CARGO
FAIRCHILD							
8115FD2	150056	33331115	150764	46481639	150451	5556508	150809
SH4240	150058	33331115	180649	46520412	160365	55702442	261338
SH4243	150055	384114A1	160919	46530556	100639	5882107	160308
SH4246	150056	4067872	180804	46533308	181495	5927407	150772
SH4279	150056	4067916	180726	46541253	181495	5927407	180631
SH4333	150056	4071394	150395	46543562	150246	5946923	160354
SH4418	150058	4108672	180804	46548037	150246	5946932	160354
		4114572	181001	4655982	181494	5950464	100511
		4124209	180726	46722702	261333	5951861	100511
		4133922	150809	46722948	261331	5951879	100511
		4141538	180945	46722956	261347	5951880	100511
		4151243	150772	46723433	261350	5951881	100511
		4151243	180631	46742375	161737	5951882	100511
		4151246	150772	46751764	100639	59635160	181584
		4151564	150772	46754154	100645	5967744	150809
		4151564	180631	46777286	150903	5972332	180875
		4152127	180631	46777287	150571	5973752	100511
		4163888	180945	46777288	150609	5973753	100511
		4165210	180790	46779614	100627	5973754	160426
		4169122	180945	46786042	150354	5979027	160197
		4177122	180726	46794782	150586	5990986	160424
		4177124	180726	46796050	100627	5992746	181021
		4185217	180945	46807091	161737	60524288	150055
		4189508	180945	4714294	100511	60506902	180634
		42046397	171230	4729585	100511	60518322	070054
		4220161	150809	4738576	100511	60522876	160352
		4220470	180726	4752281	100284	60523427	150543
		4220471	180726	4754011	100511	60534316	160353
		4235333	181001	4774412	100511	60546091	070053
		4263597	181001	4774413	100511	605581530	150379
		4276954	180804	4781356	100511	60562702	150387
		4304418	180631	4783047	100511	60572202	150527
		4305685	180631	4792112	160424	60572202	150913
		4318331	181001	4833643	100511	60576437	150543
		4320622	160308	4841294	100511	60581530	150379
		4320627	160308	4849406	100511	60590027	150543
		4334613	180945	4859913	150759	60590028	150055
		4340878	181001	4859913	150805	60590029	150055
		4345643	180726	4859914	150759	60593844	150759
		4345645	180726	4859914	150805	60593844	150805
		4349082	180804	4988617	150809	60593845	150759
		4379249	160327	4998770	180631	60593845	150805
		4384184	150395	50008757	150759	60593846	180634
		4384372	160327	50008757	150805	60595694	180634
		4386221	150917	500312468	150759	60623365	150913
		4393814	100511	500312468	150805	60733358	181584
		4407984	180804	500382599	181395	60755012	150057
		4409505	180804	504678	090076	60755094	150057
		4414583	150809	51771823	161737	60779188	070054
		4414599	150809	51774422	181590	60800123	160354
		4414600	180804	51888255	161737	60801874	161737
		4414779	180945	5430044	180950	60808142	180875
		4419628	150058	5493206	100511	60808371	150759
		4421193	070053	55180004	150903	60808371	150805
		4422049	150809	55187333	150354	60808711	080390
		4429209	070053	55189517	150354	60808979	160197
		4430291	181584	55192494	081115	60809477	150379
		4431182	150772	55198090	161735	60809606	150252
		4431182	180631	551980900	160436	6081037	070053
		4448131	180804	55200817	100645	60814715	181395
		4459907	150809	55201610	181591	60814769	150451
		4460205	150395	55202374	150759	60814852	181495
		4460210	070053	55210051	100690	60815294	100671
		4460464	070053	55213613	150564	60816316	161737
		4460646	070053	55214926	150565	6081644	181494
		4473333	180631	55216915	150354	61617002	100527
		4474413	100511	55218148	181591	631331116	180790
		4477218	080390	55222112	181591	633331115	180649
		4552281	100511	55224494	150564	6553306205	150794
		46420838	150759	55229959	150568	655331172	181001
		46428175	160426	55231256	150569	6553321200	150794
		46434552	181589	55233423	150806	6553321205	150794
		46437264	150451	55234131	150569	68148354AA	150766
		46443793	160197	55246099	150609	69657138	100671
		46447503	181495	55331172	181001	7110531	090020
		46447610	100650	553321200	150794	71713981	100671
		46451951	100534	553321205	150794	71734232	261333
		46452813	181589	55354325	150766	71735464	100639
		46469917	181495	55556818	181591	71735480	261331
FARCOM							
103005	150056						
103005	150098						
103006	150098						
103010	150633						
FAUN							
0796720	090015						
1731134	160337						
1731-134	160216						
1731168	160216						
99700589082	160337						
99707034820	160270						
EA4-052	160337						
FEMSA							
314271	150055						
36435C	150669						
9220331386	150395						
B11286	150395						
BJ12X109	150669						
BW121	150395						
FENDT							
3539335M92	160265						
4270844M1	160282						
4272431M1WIRD965453	160919						
4272432M1	160403						
4295879M1	160337						
4299489M1	160216						
D26732913	160366						
F281.201.710010	090202						
R1863700014	160337						
V836879546	192586						
VT32249700	160674						
X825200418	190767						
X830250007	160265						
FERRARI							
110350	160265						
110356	160265						
121515	181585						
124717	160354						
137511	150379						
138225	150387						
142514	181589						
143216	150395						
146650	181589						
155010	181589						
157992	160403						
161853	181589						
162462	181590						
165170	181588						
171707	181495						
180915	181592						
311609	160423						
62370600	160353						
654603	070203						
FIAT							
10171194	192998						
1054806323	180634						
11129885	160365						
112016	181584						
12345123	181584						
1324369080	181495						
221122451	150543						
31331116	180790						

ACCESSORIES

O. E. M. names and numbers are used for reference purposes only.

OE No.	HC-CARGO	OE No.	HC-CARGO	OE No.	HC-CARGO	OE No.	HC-CARGO
FIAT continued							
71739275	181591	9621000680	181373	1314271	150637	3024539	150768
71739725	150650	9622889780	150259	1317972	150416	3024539	150798
71742420	150605	9625203680	160432	1322402	150637	3027948	150813
71749462	150759	9629968880	181076	1350562	150558	3240239	150809
74061644	090020	9637465980	150354	1360553	150580	3248349	150809
75204364	080696	9659173880	150801	1363198	150801	3600688	150768
7531177	080696	975301258	150055	1371947	150784	3600688	150798
75491289	181156	9753182280	150057	13A025C	160919	3600688	180641
7554136	070054	9753293180	150055	13A025H	160311	3802334	181590
7563225100(3)	100566	98424793	180875	1414897	180636	3898281	181585
7576067	160353	9917923	080205	1428055	150779	3914864	181590
7582152	150612	9917950	080194	1447128	100663	3M5Q9E568CA	081209
7588802	180804	9928977	090016	1458400	150558	3S719278AB	150801
7588847	180945	9929742	080696	1459278	150558	3S719279A	150801
7588882	180804	9940095	150088	1461875	150769	4103736	150813
7588920	180945	99434621	160216	1461878	150779	4132108	150768
75896560	160426	9944875	080388	1471423	181590	4132108	150794
7597693	070054	99455420	181395	1473323	150395	4176808	150813
760428	090016	9946359	080777	1473356	100674	4699549	150813
7612955	150098	9946958	080777	1474549	150395	4L3A9G444AA	181591
7626232	150246	99488730	160671	1486937	150395	4L3Z9G444AA	181591
7628059	160353	9950523	080777	1504333	150917	4M5E12A366AA	150637
7635535	070053	9950594	080777	1505155	150395	4M5G12029ZA	150558
7648797	150252	9950771	080388	1527105	181591	4M5G12029ZB	150558
7648798	150379	9959826	090016	1535416	150759	4M5G12A366BA	150637
7663177	150612	F2VB	100511	1574754	160265	4M5G12A366BB	150637
76647630	160426	F4VB	100511	1578771	150637	4M5G12A366BC	150637
7672018	150246	FU2A	100511	1583836	180820	4M5Z12029B	150637
7681395	150759	FU4A	100511	1587444	100511	4M5Z12029BC	150637
7681395	150805	K68096437AA	150806	1590417	100303	4R8Q12B533AA	161737
768702	090020	K68096456AA	150759	1610486	181147	5000970	150917
7698431	150612	K68148354AA	150766	1610487	181147	5006103	150917
7705830	150759	TGE422L	160671	1619343	150416	5006104	150395
7705830	150805			1630263	160418	5010518	AS301
7706596	150759	FORD		1630363	160418	5047437	150637
7706596	150805	01257137	180634	1637546	150165	5S65 9F472 AA	181591
771333	090015	01669963	180634	1647828	180636	5S659F472AA	181591
7717686	160352	0409160	180636	1649067	150416	6005474	181147
7717886	160352	06053460	160265	1652164	181147	6015107	160083
772051	080696	1008464	150516	1652479	160419	6027829	160216
7726125	160424	1008792	100531	1652613	160535	6033136	181147
7735920	100511	1018139	150416	1669948	180883	6058836	180820
77359200	100511	1025958	181590	1669949	180848	6063505	100511
77363824	261350	1027283	150669	1669963	180634	6075812	100303
7739275	181591	1027970	180636	1669963	180694	6077429	150669
7746152	150612	1035595	181592	1669964	180688	6080608	180636
7746154	150612	1035875	090197	1669965	180861	6083293	190766
7748867	181021	1037204	100436	1669977	100436	6086163	180636
7750753	160354	10533108	181590	1669989	150789	6109051	150067
7750754	160353	1053881	150801	1677293	181590	6120663	181008
7777960	150354	1053882	150801	1690048	100527	6127983	070055
7778982	150403	1066102	150416	1813921	080739	6127985	070055
7787256	150354	1066811	150785	1824690	100686	6128929	080427
7798691	150354	1067601	150416	1873921	080739	6132224	100303
79026637	090020	1070613	181369	19017170	150417	6132244	100303
8122111	090015	1075786	150416	1952464	100306	6132246	100303
8122186	090076	1079401	100565	1953302	150901	6132248	160418
82304822	180726	1084764	150801	1953306	150901	6135152	080696
82308678	070053	1094739	150779	1953653	150774	6140095	080397
82345473	181584	1095149	150801	1953654	150774	6143688	160416
82369531	150058	1096527	100561	1958438	160197	6145938	160350
82461742	160083	1100010750	160216	1961085	150774	6149716	AS301
9008563	080696	1100619	181400	1F539F472BA	181589	6149717	AS301
915000965558	150252	1108808	150769	1F5Z9F472BA	181589	6153380	150072
9150242380	180950	1111936	261314	1L2T14A464TA	192902	6153451	150057
9186401	080803	1113382	181590	1M2115520AA	181456	6153469	160535
9464242580	261334	1119746	181456	1M2118B515AA	100527	6154381	150546
9601810880	181201	1119835	150416	1M219278BA	150779	6154593	100511
9601811080	181194	1124770	181400	1M219278AA	150769	6156582	150098
9603324880	181373	1130402	150416	1S6A9 G444 BA	181590	6158319	070055
9607405480	150259	1133441	181590	1S7F9 G444 BB	181590	6159437	150057
9607405482	150259	1147420	181590	1S7G12029AB	150416	6160195	171162
9609352480	181194	1148070	181591	1S7G12029AC	150416	6161570	160350
9612358180	160629	1148105	100593	1U5T9278BA	150813	6161789	AS301
9614167780	160432	1206977	150769	256Q6M090AA	100593	6163811	100303
9615938380	160436	1213353	181456	2S6A9 F472 BB	181590	6164926	100303
961595948	160434	1224925	150637	2S6A9 G444 BA	181591	6165570	070055
9616572480	100511	1257137	180634	2S6A9G444BA	181591	6165571	070055
9619403780	180785	1309298	150801	2S6Q6M090BB	100663	6169693	181589

OE No.	HC-CARGO	OE No.	HC-CARGO	OE No.	HC-CARGO	OE No.	HC-CARGO
6170902	180636	84FF6M090B2A	100303	98AB 9F472 BB	181590	E6DZ9F472B	181584
6171402	160418	84FF6M091BA	100511	98AB9278CA	150801	E6SZ 9F472 A	181584
6188591	160416	84FF6M090B1A	100511	98AB9278AA	150801	E6SZ9F472A	181584
6193368	180893	84FF6M090B2A	100511	98BF12024AB	150416	E6ZF 9F472 AB	181584
6194291	160419	84SF12K057AA	150072	98FB9278AA	180636	E6ZF 9F472 BA	181584
6198827	180954	84SF12K059AA	150072	98VW12A223AA	150406	E6ZF9F472AB	181584
6201102	090197	84SF12K067BA	150057	98W13480AA	181369	E6ZF9F472AC	181584
6213125	180636	85AG9P704AA	160350	9968969	160647	E6ZF9F472BA	181584
6485688	150577	85BB9350AA	070055	9S519278AA	150759	E6ZF9F472CA	181584
6499475	150785	85GB9350BA	070055	9X2Q6M090AC	100683	E6ZF9F472AA	181584
6499475	180636	85GB9350AA	070055	A710X12K018E2	150395	E6ZZ 9F472 A	181584
6503279	150416	85GG9P704AA	160350	A710X12K018AA	150917	E6ZZ 9F472 B	181584
6503280	150416	86AB12K064AA	150098	A710X12K018E2A	150395	E6ZZ9F472A	181584
6513125	180636	86AB9278BA	180636	A730X12K018FA	150917	E6ZZ9F472B	181584
6539671	180636	86AB9278BB	180636	A790X12K018BA	150917	E73F 9F472 BA	181585
6539971	180636	86BB9350AA	070055	A790X12K018CA	150395	E73F 9F472 CA	181585
6590140	180953	86BF12K062AA	150057	A790X12K018CA	150395	E73F 9F472 AA	181585
6590141	180954	86GB12024AA	150669	B3124Q03A	150068	E73Z 9F472 A	181585
6696033	171162	86GB9350BA	070055	B6T12029A	150395	E73Z 9F472 B	181585
6716335	150785	86VB17K624AA	160535	BE8Z12029Z	150558	E73Z 9F472 BA	181585
6716335	180636	87AB 9F472 AA	181589	C3TZ12029A	150395	E73Z12029A	150669
6756611	160418	87AB17K624AC	160535	C6AH12171A	150395	E73Z9F472C	181591
6756612	160419	87AB9F472AA	181589	D0HZ9278A	180636	E7GZ9278A	150794
68477572	160419	87GB 9F472 BA	181585	D7NN14N089A	160265	E7RY 9F472 A	181585
6860289	150416	88BG8B658AA	160416	D8EE9F472AA	181584	E7SF 9F472 BA	181585
6917393	AS301	88SF12029A2A	150416	D8FZ9F472A	181584	E7SF 9F472 CA	181585
6M219278BA	150779	88SF12029AA	150416	D9AE9F472AB	181584	E7SF 9F472 AA	181585
6M219278AA	150769	89BF12024A1B	150416	D9AE9F472AA	181584	E7TE 9F472 DA	181585
6M5G9278AA	150784	89FB6M092AA	160419	D9EE 9F472 AB	181584	E7TE 9F472 EA	181585
6R8312A366BA	150898	89FF6M090AA	100303	D9EE 9F472 AA	181584	E7TF 9F472 CA	181585
6U5Z9278L	150813	89FF6M091AA	100303	D9EE9F472AB	181584	E7TF 9F472 DA	181585
7003178	160535	904F9350AB	090197	D9EE9F472AA	181584	E7TF 9F472 EA	181585
703F9P631AAA	080696	90BB6M092BA	160419	D9FZ 9F472 A	181584	E7TZ 9F472 B	181585
7072673	100511	90BB6M092BB	160419	D9FZ9F472A	181584	E7TZ 9F472 E	181585
7133973	090197	90BB6M092CA	160419	E0DE9F472AA	181584	E8308395	080427
7188531	261305	90BB6M092AA	160419	E0FZ9F472B	181584	E836240S	080696
71BG15520EA	181147	90GB108843AA	180636	E0ZE9F472AA	181584	E8BZ 9F472 A	181584
71BG15520FA	181147	90GB108843AA	180953	E17Z12A199A	150068	E8BZ12A297A	150417
71HM12024BA	150917	910X6M090BA	100511	E1AF 9F472 AA	181584	E8BZ21A297A	150160
71HM12024AA	150395	914F9350AA	090197	E1AF9F472AA	181584	E8BZ9472A	181584
7235770	AS301	91AB10884AA	180893	E1AZ 9F472 A	181584	E8GY 9F472 A	181584
743F9C358AA	090076	91AB8B607A1A	180893	E1AZ9F472A	181584	E8GY9F472A	181584
74HB18K877AA	160216	928F12029CA	150416	E1SE9F472AA	181584	E8GY9F472F	181584
76BG15520A	181147	92GB12024AA	150669	E1SF9F472AA	181584	E8TZ 9F472B	181585
76BG15520A/B	181147	92VW8502AA	070192	E2FZ12A297A	150064	E9ZZ12A297A	150160
76BG15520AB	181147	93151848	090197	E3BF9F472AA	181584	E9ZZ9F472A	181584
76BG15520AIB	181147	938F12024DA	150416	E3EF 9F472 BA	181584	E9ZF 9F472 CA	181585
76BG15520B	181147	93AB 9F472 CA	181590	E3EF 9F472 AA	181584	E93F 9F472BA	181585
76BG15520AA	181147	93BB6M090A2A	100511	E3EF9F472BA	181584	E97F 9F472 BA	181585
77BB12024AA	150669	93BB6M092BA	160469	E3EF9F472AA	181584	E97F 9F472 CA	181585
77FB10884AA	180820	93BB6M092AA	160469	E3FZ 9F472 A	181584	E97F 9F472 DA	181585
785F6M090BA	100511	93FF6M090AA	100303	E3FZ9F472A	181584	E9BZ 9F472 A	181584
785F6M090CA	100511	94BB 9F472 BB	181590	E3TZ 9F472 B	181584	E9BZ9F472A	181584
786B6M090CA	100511	94BB 9F472 DA	181590	E3TZ9F472B	181584	E9SF 9F472 BA	181585
78GB6M090CA	100511	94DD6M090AA	100511	E43Z 9F472 A	181584	E9SF 9F472 CA	181585
795F6M090BA	100303	95DD6M090AA	100527	E43Z9F472A	181584	E9TF12029AA	150416
795F6M090CA	100303	95VW10884BA	180848	E47F 9F472 AA	181584	E9ZZ12A297A	150160
795F6M090AA	100303	95VW10884AA	180883	E47F9F472AA	181584	EDY4	150067
79BB12024AA	150669	95VW12029AA	150516	E4TF9F47AA	181584	EODE 9F472 AA	181584
79NU9278A	150809	95VW12A648BA	180861	E53F9F472AA	181584	EODE9F472AA	181584
7M1819021D	261317	95VW6M090AA	100436	E53Z 9F472 B	181584	EOFZ 9F472 B	181584
81873921	080739	95VW8502BA	070192	E53Z9278A	150794	EOFZ9F472B	181584
81AB9278BA	180636	95VW8502AA	070192	E53Z9F472B	181584	EZD30	100511
81AB9278AA	180636	95VW9278BA	180694	E63F 9F472 AB	181584	EZD36	100527
81AE9278BA	180636	95VW9278CA	180688	E63F 9F472 BA	181584	EZD37	100565
82006984	070134	95VW9278EA	150779	E63F 9F472 AA	181584	EZD8	100303
83BB006M092BA	160416	96BB 9F472 BA	181590	E63F9F472AB	181584	F0212A297A	150160
83BB12A199B3A	150067	96BB 9F472 BB	181590	E63F9F472BA	181584	F02Z 9F472 A	181584
83BB6M090A1A	100511	96BB 9F472 AA	181590	E63F9F472AA	181584	F02Z 9F472 B	181584
83BB6M090A2A	100511	96BF12024A1B	150416	E63Z 9F472 A	181584	F02Z 9F472 C	181584
83BB6M092BA	160416	97CT15K234AA	160215	E63Z9F472A	181584	F02Z12A297A	150160
83BB6M092AA	160416	97CT15K235AA	160215	E6DF 9F472 A1A	181584	F02Z9 F472 AA	181584
83GB88607A2B	181008	97FB10884AA	180893	E6DF 9F472 B1A	181584	F02Z9F472A	181584
83GB88607A2B	181008	988F12024AB	150416	E6DF9F472A1A	181584	F02Z9F472B	181584
84BB6M090AA	100511	988F12029AB	150416	E6DF9F472B1A	181584	F02Z9F472C	181584
84FB6M092BA	160418	988F12029AC	150416	E6DF9F472AA	181584	F02Z9F472AA	181584
84FB6M092CA	160418	988F12029AD	150416	E6DZ 9F472 A	181584	F0BZ9F472B	181584
84FB6M092CB	160418	988F12029BA	150416	E6DZ 9F472 B	181584	F0BZ9F472C	181584
84FF6M090B1A	100303	988F1209AB	150416	E6DZ9F472A	181584	F0C69F472EB	181584

ACCESSORIES

O. E. M. names and numbers are used for reference purposes only.

OE No.	HC-CARGO	OE No.	HC-CARGO	OE No.	HC-CARGO	OE No.	HC-CARGO
FORD continued				GE LIGHTING			
F0JY12A297B	150417	F6DZ 9G444 CA	181590	3057NA	170711	90069100	181150
F0JY9F472A	181584	F6DZ 9G444 E2A	181590	3157	170710	90069864	160297
F0JY9F472B	181584	F6DZ 9G444 EA	181590	886	170951	90080939	180875
F0SZ 9F472 B	181585	F6DZ 9G444 AA	181590	886	171953	90114676	150056
F0TZ 9F472 E	181585	F6MF 9F472 AA	181590	894	170726	90124673	160352
F1CF9F472A	181584	F6MF 9F72 AA	181590	9004	170692	90140187	150056
F1CZ 9F472 A	181584	F6MZ 9F472 AA	181590	9005	170693	90158189	160352
F1CZ9F472A	181584	F6RZ 9F472 AA	181590	9006	170694	90158443	160352
F1UF 9F472 AA	181590	F6XA 9F472 BA	181590	GENERAL MOTOR			
F37Z12029A	150416	F6XA 9F472 CA	181590	01985703	150064	90230894	160295
F3XA12029AA	150901	F6XA 9F472 CB	181590	03439088	180808	90225811	160295
F3XY12029A	150901	F6XA 9G444 AA	181590	090040992	160416	90230894	160295
F4AF 9F472 A	181590	F6XZ 9F472 CA	181590	090228928	160416	90240698	160295
F4AZ 9F472 A	181590	F6ZF 9G444 AA	181590	090341822	160416	90240811	160295
F4BZ 9F472 A	181584	F6ZZ 9G444 AA	181590	09110560	150404	90243630	150380
F4BZ9278A	150764	F72Z 9F472 GG	181590	10450424	150619	90245033	181182
F4BZ9278A	150768	F7XA 9F472 CA	181590	10457075	150403	90246852	180808
F4BZ9278A	150783	F7XA 9F472 FB	181590	10457870	150884	90276101	160416
F4BZ9278A	150798	F7XA 9F472 FC	181590	10458316	150650	90295498	150055
F4BZ9F472A	181584	F7XZ 9F472 FA	181590	10469931	150239	90295499	150055
F4SF 9F472 AB	181590	F7XZ 9F472 FB	181590	10482823	150062	90335039	150762
F4SF 9F472 DA	181590	F8AF9278BB	150813	10482824	150063	90336039	150762
F4SZ 9F472 A	181590	F8CZ 9F472 BB	181590	10482825	150064	90341822	160416
F4SZ 9F472 D	181590	F8RZ 9G444 BB	181590	10490192	150619	90350929	150541
F4ZF 9F472 A	181590	F8XZ9F472CA	181589	10496048	150239	90360314	150380
F4ZF 9F472 AB	181590	FB006M092BA	160418	1103872	150403	90378651	160295
F4ZF 9F472 BB	181590	FB006M092CB	160418	1103905	150403	90410792	180875
F4ZZ 9F472 A	181590	FO2Z 9F472 C	181584	1103982	150403	90414405	150055
F4ZZ 9F472 AB	181590	FO2Z9F472A	181584	1104003	150403	90423761	181495
F4ZZ 9F472 B	181590	FO2Z9F472B	181584	1104038	150619	90449435	181088
F5AF 9G444 AB	181590	FO2Z9F472C	181584	1104047	150619	9045825	150668
F5AF 9G444 BB	181590	FO2Z9F472AA	181584	1104082	150650	90482454	181182
F5AZ 9G444 A	181590	FOBZ 9F472 B	181584	1115033	150395	90507539	150762
F5AZ 9G444 B	181590	FOBZ9F472B	181584	1115043	150395	90510183	180875
F5CZ 9F472 A	181590	F0JY 9F472 B	181584	1115062	150395	90534902	150766
F5LY12029A	150416	F0JY9F472B	181584	1115066	150395	90536194	150525
F5MF 9F472 A2A	181590	F0SZ 9F472B	181585	1208021	150650	90541520	181395
F5MF 9F472 B1B	181592	F0TZ 9F472E	181585	16010892	150063	90541937	181395
F5MF 9F472 B2B	181592	JE50 18861 A	181590	16017433	150062	90542063	181395
F5MF 9F472 BA	181592	KLA6 18861	181590	16139379	150239	90569684	150762
F5MF 9F472 BB	181592	N805481S36	192591	16139889	150063	9108194	150807
F5MF 9F472 DB	181592	N807805S36B	191657	16140039	150239	9109810	180905
F5MF 9F472 DC	181592	Q14F9350AA	090197	16140049	150063	9110231	150775
F5MF 9F472 AA	181590	V76HB15442BB	171171	16158829	150063	91112377	180641
F5MZ 9F472 B	181591	V85AB9P704AA	160354	16410049	150063	91167210	160795
F5MZ 9F472 DB	181592	V94DD6M090AA	100511	19005212	150521	9118368	150468
F5MZ 9F472 AA	181590	V94DX6M090AA	100511	1977958	150063	9119567	150525
F5MZ9F472B	181591	V95CT13380AA	171230	1978432	150063	91298691	181395
F5RZ 9F472 B	181590	V95DD6M090AA	100527	1979107	150063	9132691	161736
F5RZ 9F472 D	181590	W500200S437	191545	1979571	150063	9193149	181494
F5RZ 9F472 DA	181590	XF 251 432	181584	1985342	150063	9201425	181495
F5WF 9F472 BA	181590	XF251432	181584	1985703	150064	9201699	160795
F5WZ 9F472 BA	181590	XF529F472HA	181589	24420584	150633	9202575	181590
F5XA12029AA	150901	XF529F472HB	181589	24437502	181491	9204425	181495
F5XZ12029AA	150901	XF529G444CA	181589	24461315	150806	9227760	181494
F62Z 9F472 BB	181590	XF5Z9F472GA	181589	25163212	100548	93160284	150791
F62Z 9F472 DD	181590	XF5Z9F472HA	181589	25168651	100548	93171335	181495
F62Z 9F472 FF	181590	XF5Z9F472HB	181589	25180905	150759	93171527	181491
F62Z 9F472 GG	181590	XF5Z9G444CA	181589	30520357	150796	93171627	181491
F62Z9F472EE	181589	XL3F 9F472 AA	181591	55202374	150759	93175295	150761
F62Z9F472AA	181589	XL3F9F472BA	181591	55354325	150766	93177212	150633
F6C6 9F472 AA	181590	XL3F9F472CA	181591	55354378	150762	93177490	150759
F6CF 9G444 BA	181590	XL3F9F472DA	181591	55561655	150652	93177490	150805
F6CF 9G444 CA	181590	XL3F9F472AA	181591	55581588	150767	93178047	100627
F6CF 9G444 DA	181590	XL3Z 9F472 BA	181592	55584404	150651	93180245	150780
F6CF 9G444 DB	181590	XL3Z 9F472 AA	181592	6240251	150805	93190433	100688
F6CF 9G444 DC	181590	XL3Z9F472BAFC	181591	836584	181494	93190643	150767
F6CZ 9F472 AA	181590	XL3Z9F472C	181591	836590	181494	93192725	150775
F6CZ 9G444 BA	181590	XL3Z9F472D	181591	836592	181494	93193582	150759
F6CZ 9G444 DA	181590	XM218A570BA	181400	88900715	100537	93194165	150911
F6CZ 9G444 DB	181590	XM219278BA	150769	90006145	150056	93198166	150763
F6DF 9G444 B2A	181590	XM349278CA	150794	90006499(2)	150098	93198196	150791
F6DF 9G444 BA	181590	XS4H18456AD	261314	90006964	150098	93198197	150807
F6DF 9G444 E1A	181590	XS7H6M090AA	100669	90008145	150056	93318082	150762
F6DF 9G444 E2A	181590	YR8H19G405BA	190527	90056698	150056	93858431	161120
F6DF 9G444 EA	181590	YS6A 9F472 AC	181590				
F6DF 9G444 AA	181590	Z590141	180954				
F6DZ 9G444 B	181590						
F6DZ 9G444 C	181590						

OE No.	HC-CARGO	OE No.	HC-CARGO	OE No.	HC-CARGO	OE No.	HC-CARGO
94175158	100657	1650-12	060266	4DB001887-021	160243	4RP008189-041	160352
94205866	180875	1650-24	060267	4DB001887-022	160243	4RP008189-051	160295
94312940	150770	2000-12	060245	4DB002478-171	160242	4RP008189-061	160372
94404544	150157	2000-24	060246	4DB002895-011	160242	4RP008189-081	160374
94472002	180808	2100-12	060223	4DB002895-012	160242	4RP008189-091	160375
94845488	150794	2100-24	060233	4DB003675-001	160261	4RP008189-111	160353
94847544	150794	3000 M-12	160483	4DB003750-071	160242	4RP008189-121	160354
94851293	150794	3000 M-24	160649	4DB003750-151	160242	4RP008189-151	161121
94855502	150266	30130013	160966	4DB004124-002	160341	4RV008188-001	160441
94859441	150614	3031-12	060247	4DB004124-003	160312	4RV008188-011	160442
94859442	150614	3031-24	060235	4DB004225-001	160305	4RV008188-021	160443
95961350	150762	3050-30	060219	4DB004225-002	160305	4RV008188-041	160445
96052138	180641	3055-12	060216	4DM001861-181	160262	4RV008188-051	160446
96053621	180641	3055-24	060220	4DM003360-001	160244	4RV008188-061	160447
96476983	150652	340.06.021	060268	4DM003360-002	160244	4RV008188-071	160448
96494264	150762	340.30.023	181674	4DM003390-011	160244	4RV008188-081	160423
96802844	150766	5061-12	060271	4DM003460-021	160314	4RV008188-091	160424
97210818	100555	5061-1248	060248	4DM003460-027	160314	4RV008188-101	160425
97327722	081173	5061-12L	060270	4DM003640-051	160305	4RV008188-111	160426
97358626	100555	51219	180314	4DM003640-052	160305	4RV008188-161	160416
97375663	150787	62338	060260	4DM003944-041	160262	4RV008188-171	160420
98013014	150770	62348	060261	4DN003438-007	160263	4RV008188-179	160420
D504	150395	65707	060237	4DN003438-011	160263	4RV008188-181	160421
D513	150395	66221	060262	4DN003438-047	160263	4RV008188-201	160417
E73Z12029A	150669	66231	060229	4DN003438-067	160263	4RV008188-211	160418
MD080624	150917			4DN003438-127	160263	4RV008188-221	160419
U501	150395			4DW003944-051	160199	4RV008188-241	160438
		HELLA		4RA003437-041	160239	4RV008188-271	160431
		1A3996026-011	171038	4RA003437-047	160239	4RV008188-281	160432
		1GA007506-011	170857	4RA003437-051	160240	4RV008188-301	160434
		1GA007506-091	170857	4RA003437-057	160240	4RV008188-321	160436
		1GA998532-011	170859	4RA003437-091	160240	5DA006623-001	150055
		1GB996386-001	172191	4RA003437-097	160240	5DA006623-011	150056
		1GB996386-002	172191	4RA003510-081	160083	5DA006623-031	150075
		1GB996386-021	172191	4RA003510-111	160282	5DA006623-041	150057
		1AA004109-041	170867	4RA003510-157	160307	5DA006623-051	150058
		2BE003014-251	170925	4RA003510-267	160265	5DA006623-061	150062
		2KA001386-281	170936	4RA007507-041	160282	5DA006623-071	150064
		2KA001389-101	171166	4RA007782-011	160363	5DA006623-151	150068
		2KA001389-101	171224	4RA007791-011	160282	5DA006623-161	150088
		2KA997011-021	171224	4RA007793-031	160282	5DA006623-181	150154
		2NE001412-091	170930	4RA007793-037	160282	5DA006623-241	150072
		2NE003315-011	170928	4RA007813-011	160365	5DA006623-251	150175
		2PF001638-011	170875	4RA007813-017	160365	5DA006623-261	150067
		2PF003057-041	171171	4RA933332-111	160215	5DA006623-371	150157
		2PF997027-011	171322	4RA933332-117	160978	5DA006623-401	150236
		2PG003057-011	171174	4RA933766-111	160365	5DA006623-411	150096
		2PG003057-061	171174	4RA965400-031	160215	5DA006623-421	150160
		2PG003057-067	171174	4RD001838-011	160081	5DA006623-431	150165
		2PG006717-021	170887	4RD001838-021	160216	5DA006623-461	150215
		2PS003057-051	171175	4RD003520-031	160308	5DA006623-471	150384
		2PS006717-031	170884	4RD003520-071	160337	5DA006623-481	150234
		2PS006717-061	170885	4RD003520-072	160337	5DA006623-491	150378
		2SA003057-021	171173	4RD003520-081	160081	5DA006623-511	150377
		2SA997027-001	171331	4RD003520-091	160216	5DA006623-581	150063
		2SD001685-341	171329	4RD003520-093	160337	5DA006623-591	150409
		2SD001688-141	170893	4RD003520-097	160337	5DA006623-601	150379
		2SD001688-171	170895	4RD003520-127	160337	5DA006623-611	150387
		2SE001685-331	171328	4RD003520-131	160308	5DA006623-621	150227
		2SE357032-011	171202	4RD003520-251	160216	5DA006623-731	150380
		2TJ003168-051	171196	4RD003520-257	160216	5DA193175241	150889
		2TJ781000-001	170668	4RD007783-011	160365	5DA193175251	150902
		2TJ801000-001	170640	4RD007794-021	160403	5DA193175491	150574
		2VD007323-031	170916	4RD007794-021	160403	5DA193175491	150608
		2VD007323-041	170917	4RD007794-031	160403	5DA193175851	150623
		2VD007323-131	170922	4RD007814-011	160919	5DA193175851	150623
		2VD007323-141	170923	4RD007814-017	160919	5DA193175961	150902
		2VD007500-091	171447	4RD007814-031	160919	5DA193175971	150889
		2VP007323-021	170917	4RD007903-001	160337	5DA749475791	150625
		2VP007323-121	170923	4RD007903-011	160216	5DA749475981	150623
		2XD012160-801	171813	4RD007903-017	160216	6PU009146121	150354
		2XD012160-851	171814	4RD933319-007	160919	6PU009146461	150451
		2XD012160-861	171933	4RD933332-061	160216	6ZF007391001	150770
		2XS005639-001	171196	4RD933332-067	160216	6ZF007391001	150786
		2ZR001389-101	171224	4RD933332-071	160337	6ZF007392001	150768
		2ZR001423-001	170934	4RD933332-077	160337	6ZF007392001	150777
		2ZR002985-081	170935	4RD933332-091	160337	6ZF007392001	150783
		2ZR002985-264	170935	4RD933332-097	160337	6ZF007392001	150786
		4DB001887-001	160243	4RP008189-021	160350	6ZF007392001	150798
		4DB001887-002	160243	4RP008189-031	160352	6ZF007394001	150764

ACCESSORIES

O. E. M. names and numbers are used for reference purposes only.

OE No.	HC-CARGO	OE No.	HC-CARGO	OE No.	HC-CARGO	OE No.	HC-CARGO
HELLA continued							
6ZF007394001	150768	8EW009157111	261329	HITACHI			
6ZF007394001	150777	8EW009157131	261307	080253	080253	B-119	100639
6ZF007394001	150783	8EW009157171	261339	080256	080256	CP-01	100302
6ZF007394001	150798	8EW009158111	261332	132049	161736	CP-02	100326
6ZF007396001	150802	8EW009158211	261336	132165	160447	CP-03	100336
6ZL003259-011	180634	8EW009159081	261310	134045	150627	CP-05	100563
6ZL003259-061	180634	8EW009159131	261311	191489	191489	CP-07	100510
6ZL003259171	150809	8EW009159271	261334	210843	210843	CP-22	100429
6ZL003259181	150796	8EW009159281	261335	210948	210948	CP-50	100513
6ZL003259191	150809	8EW009159301	261320	2114-2835	190537	CP-51	100555
6ZL003259201	150809	8EW009159461	261356	2114-2867	190482	CP-52	100662
6ZL003259311	150794	8EW009159481	261348	2114-3835	190537	CP-70	100324
6ZL003259321	150764	8EW009159581	261353	2114-58005	191584	CP-71	100325
6ZL003259321	150768	8EW009160-641	161719	2114-5866	190480	CP-72	100560
6ZL003259321	150777	8EW351000341	261316	2114-5867	190482	PD-190	100257
6ZL003259321	150783	8EW351039311	261331	2114-68005	191873	PD-191	100283
6ZL003259321	150786	8EW351039321	261347	2114-7867	192063	PH-22	100658
6ZL003259321	150794	8EW351039331	261350	2116-1131	190806	PH-23	100658
6ZL003259321	150798	8EW351039371	261333	2116-1491	190820	PH-25	100657
6ZL003259331	150770	8EW351040521	261345	2116-1501	190818	PI-42	100275
6ZL003259-351	180634	8EW351043221	261309	2116-1502	190818	PI-44	100658
6ZL003259-361	180634	8EW351043451	261349	2116-1511	191358	PI-46	100245
6ZL003259-391	180634	8EW351044251	261327	2130-3822	192063	PI-49	100657
6ZL003259-411	180634	8EW351044281	261357	2240-1801	190482	PI-50	100658
6ZL003259441	180634	8EW351044291	261352	2240-6801	191326	PI-56	100657
6ZL003259461	150784	8EW351044371	160513	2250-2802	191536	PI-57	100426
6ZL003259471	150789	8EW351044371	261312	2502165	160447	PI-58	100292
6ZL003259491	150762	8EW351104791	261322	2502201	160308	PK-115	100280
6ZL003259531	150768	8EW351149371	261338	2503847	150635	PM-165	100559
6ZL003259531	150777	8EW351149614	261340	3062-1231	080875	PM-167	100670
6ZL003259531	150783	8EW351149624	261319	7120632	190480	PM-75	100246
6ZL003259531	150798	8EW351149664	261321	AIC4-004AG	150613	PM-79	100521
6ZL003259541	150774	8EW351149674	261351	B354-144	191307	PN-123	100251
6ZL003259591	150774	8EW351149694	261343	B-424588	190806	PN-124	100252
6ZL003259601	150759	8EW351149774	261337	B-424590	190820	PN-128	100254
6ZL003259601	150805	8EW351304021	261323	B-437057	191358	PN-131	100276
6ZL003259611	150799	8EW351304041	261306	C1Z500	150395	PN-132	100271
6ZL003259631	150795	8FC351300-511	160366	C1Z500E	150395	PN-135	100287
6ZL003259-641	180634	8JA001909-001	170964	C6R800	150395	PN-138	100306
6ZL00325971	150801	8JA001915-001	180399	CM11108C	150628	PN-87	100247
6ZL003259711	150801	8JA001920-001	180403	CM11108D	150628	PS-201	100433
6ZL003259731	150803	8JA002263-001	180401	CM11108M	150628	PS-202	100434
6ZL00325974	150791	8JA003525-001	190766	CM11109	150638	PS-203	100634
6ZL003259741	150791	8JA003526-001	190766	DIS405	150409	PS-204	100435
6ZL003259751	150792	8JA003526-002	190766	DIS408	150406	PS-206	100518
6ZL003259781	150786	8JA005951-051	180330	E12-117	150398	PS-207	100523
6ZL003260-001	180634	8JA103500-001	180332	E123-02	150384	PS-208	100524
6ZL006097001	150761	8JA715606-001	190767	E123-03	150384	PS-210	100522
6ZL007675001	150775	8JB001933-001	180402	IGC0051	150628	PS-216	100636
6ZL008280001	150760	8JB001944-001	180404	L150-1810	191657	PT-100	100256
6ZL008280011	150773	8JB102100-001	180329	L150-28001	192145	PT-101	100280
6ZL008280031	150769	8KV002142-031	191507	L150-28011	191528	PT-103	100260
6ZL008280051	150779	8KV002143-031	191508	L150-5810	191299	PT-104	100256
6ZL008280-061	150812	8KW744761-003	193244	L160-3801	191528	PT-107	100257
6ZL008280-061	180631	8KW744762-003	193245	L160-5801	191528	PT-108	100282
6ZL008280081	150779	8KW744767-003	193248	L170-2910	191307	PT-109	100280
6ZL008280131	150797	8KW744768-003	193247	RHW07	150917	PT-140	100258
6ZL008780021	150784	8PD003798-001	210212	U13T08COIL	150663	PT-144	100260
6ZL008780021	150810	8RA002014-031	170165				
6ZL009600031	150804	8RA002014-041	170170	HKT			
6ZL009600051	150807	8RA002014-051	170169	B-004	100079	PT-147	100277
6ZL009600071	150799	8RA002020-001	170163	B-028	100512	PT-150	100283
6ZL009600091	150764	8RA003326-011	171230	B-029	100262	PT-151	100291
6ZL009600091	150768	8TW004223-031	160197	B-031	100086	PT-154	100514
6ZL009600091	150777	8TW005206-031	160381	B-032	100303	PT-155	100516
6ZL009600091	150783	8TW005206-051	150809	B-033	100511	PT-157	100556
6ZL009600091	150798	8TW005206-051	160382	B-037	100512	PV-138	100306
6ZL009600091	150815	8TW005496-0051	160198	B-040	100511	PZ-30	100286
6ZL009600101	150785	8TW005496-011	160679	B-043	100511	PZ-33	100261
8EG008497-231	100533	8TW006847-001	160535	B-044	100511	PZ-38	100515
8EG008497-561	100592	8TW006849-001	160386	B-045	100511	PZ-39	100520
8EW009100201	261305	9DF112247-001	170621	B-049	100284	HONDA	
8EW009100251	261328	9EL786000-001	170641	B-053	100303	06302-PT2-000	150236
8EW009100301	261308	9EL787000-001	170642	B-055	100263	06302-PT2-A00	150236
8EW009100341	261344	9XD997909-801	171266	B-101	100561	06302-PT3-000	150236
8EW009100371	261315	AFSQ4A	172113	B-102	100592	06302-PTA-00	150236
8EW009100421	261346	HENCHEL		B-105	100565	12291-PLZ-D00	100555
8EW009100-461	160513	0614204001	090202	B-106	100593	12291-RBDE01	100692
8EW009100501	261342			B-107	100594	12291-RBDE01	100692
						12291-RLOG01	100692

OE No.	HC-CARGO	OE No.	HC-CARGO	OE No.	HC-CARGO	OE No.	HC-CARGO
16400-PDD-X00	181495	36531-P3Y-G02	181584	36531-PH2-004	181584	36531-PAA-A02	181591
30120-PM3-0050	150398	36531-P45-G01	181591	36531-PH2-014	181584	36531-RDJ-A01	181591
30120-PM5-A01	150236	36531-P45-G02	181591	36531-PH2-024	181584	36531-RDM-A01	181591
30120-PMA-01	150236	36531-P5A-003	181590	36531-PH3-003	181584	36531-RDM-A02	181591
30120-PR3-003	150236	36531-P5A-A01	181591	36531-PH3-013	181584	36531-RLC-J01	181591
30120-PT3-003	150236	36531-P5G-003	181590	36531-PH4-661	181584	36532-POA-A01	181591
30120-PT3-004	150236	36531-P5K-003	181591	36531-PH4-662	181584	36532-PQG-A01	181591
30130-P06-006	150384	36531-P5M-004	181591	36531-PH4-663	181584	36532-P0G-A02	181591
30130-P54-006	150236	36531-P5M-014	181591	36531-PH4-664	181584	36532-P13-A01	181591
30130-PO6-006	150384	36531-P5P-004	181591	36531-PH4-682	181584	36532-P1E-A01	181591
30500-634-005	150395	36531-P5P-014	181591	36531-PH5-004	181584	36532-P1R-A01	181591
30500634015	150395	36531-P64-004	181584	36531-PH7-003	181584	36532-P2E-A01	181591
30500-DPA-E01	150885	36531-P64-901	181584	36531-PH7-013	181584	36532-P2E-A51	181591
30500-POA-A01	150885	36531-P64-902	181584	36531-PH7-305	181584	36532-P2P-A01	181591
30500POHA01	150885	36531-P6W-A01	181590	36531-PH7-315	181584	36532-P2R-A01	181591
30500POAA01	150885	36531-P72-A01	181591	36531-PH7-732	181584	36532-P3F-A01	181591
30500PCA003	150885	36531-P75-A01	181591	36531-PJ0-661	181584	36532-P3F-A11	181591
30500PDAE01	150885	36531-P7A-003	181584	36531-PJ0-L01	181584	36532-P5A-003	181591
30500PTZ005	150270	36531-P7J-004	181591	36531-PJ0-L02	181584	36532-P5A-A01	181591
30500PTZ006	150270	36531-P8A-A01	181591	36531-PJ0-L03	181584	36532-P5G-003	181591
30500PAAA01	150885	36531-P8C-A01	181591	36531-PK1-004	181584	36532-P5M-A01	181591
30500SA0732	150537	36531-P8C-A11	181590	36531-PK1-014	181584	36532-P5M-A02	181591
30500SA5033	150917	36531-P8C-A21	181590	36531-PK2-003	181584	36532-P65-A00	181591
30500SB0013	150917	36531-P8D-J21	181590	36531-PK2-004	181584	36532-P65-A003	181591
30500SB3013	150917	36531-P8E-A01	181591	36531-PK2-013	181584	36532-P6W-A01	181591
30510P73A01	150270	36531-P8E-A11	181590	36531-PK2-L01	181584	36532-P72-A01	181590
30510P73A02	150270	36531-P8F-A11	181590	36531-PK3-A02	181591	36532-P73-A01	181590
30510-PT2-006	150270	36531-P9L-E02	181590	36531-PK3-A04	181591	36532-P75-A01	181590
30520-PDF-E01	150252	36531-PBC-A01	181591	36531-PL1-013	181584	36532-P8A-A01	181591
30520-PGK-A01	150673	36531-PBF-A11	181590	36531-PL2-003	181584	36532-P8C-A01	181591
30520-PNA-003	150630	36531-PBY-003	181590	36531-PL2-013	181584	36532-P8C-A02	181591
30520-PNA-007	150630	36531-PBY-J01	181590	36531-PL2-023	181584	36532-P8C-L01	181591
30520PNC004	150904	36531-PC7-661	181584	36531-PLM-A01	181591	36532-P8C-L02	181591
30520-PNC-004	150904	36531-PC7-662	181584	36531-PLR-A01	181590	36532-P8C-L21	181591
30520PVFA01	150673	36531-PC7-663	181584	36531-PM3-004	181584	36532-P8D-J01	181591
30520-PWA-003	150639	36531-PC7-664	181584	36531-PM4-014	181584	36532-P8F-A01	181591
30520-PWC-003	150644	36531-PC7-665	181584	36531-PM5-A01	181584	36532-P8F-A11	181591
30520-RB0-003	150622	36531-PC7-682	181584	36531-PM5-L01	181584	36532-PBF-A11	181590
30520-RB0-013	150622	36531-PCA-004	181591	36531-PM5-L02	181584	36532-PBY-003	181590
30520-RB0-S01	150622	36531-PCA-014	181591	36531-PM8-305	181584	36532-PBY-J01	181590
30520RNAA01	150615	36531-PCC-004	181591	36531-PM8-A01	181584	36532-PCX-A01	181591
30520-RRA-007	150630	36531-PCC-014	181591	36531-PM8-A03	181584	36532-PDC-E01	181591
30520RWCA01	150904	36531-PCX-000	181590	36531-PMS-A01	181591	36532-PDE-E02	181591
30520-RAA-007	150630	36531-PCX-004	181590	36531-PN4-J03	181584	36532-PDN-A01	181591
30521-PWA-003	150628	36531-PCX-014	181590	36531-PN4-N02	181584	36532-PEA-A01	181591
30521-PWA-013	150628	36531-PD2-305	181584	36531-PNB-014	181591	36532-PEL-003	181591
30521-PWA-S01	150628	36531-PD2-661	181584	36531-PO5-A01	181584	36532-PGK-A02	181591
30521-REA-Z01	150628	36531-PD2-662	181584	36531-PP0-014	181584	36532-PH7-003	181584
30521-RLB-003	150628	36531-PD2-663	181584	36531-PP0-N02	181584	36532-PH7-013	181584
36531-P01-004	181584	36531-PD2-664	181584	36531-PR4-A01	181584	36532-PHM-A11	181591
36531-P01-G01	181584	36531-PD6-661	181584	36531-PR4-L02	181584	36532-PHM-A51	181590
36531-P01-G02	181584	36531-PD6-662	181584	36531-PR7-003	181590	36532-PHX-G01	181591
36531-P05-A01	181584	36531-PDE-E02	181590	36531-PR7-A01	181591	36532-PJ0-661	181584
36531-P05-A02	181584	36531-PDN-A01	181590	36531-PR7-A02	181591	36532-PJ0-L01	181584
36531-P06-A01	181584	36531-PE1-305	181584	36531-PR7-A11	181591	36532-PJ0-L02	181584
36531-P06-A11	181591	36531-PE1-662	181584	36531-PR7-J01	181591	36532-PK2-003	181584
36531-P07-A01	181584	36531-PE1-663	181584	36531-PR7-J02	181591	36532-PK2-L01	181584
36531-P07-L01	181591	36531-PE1-A02	181584	36531-PT0-014	181584	36532-PL2-003	181584
36531-P08-004	181584	36531-PE2-902	181584	36531-PT0-J03	181584	36532-PL2-013	181584
36531-P0A-A11	181591	36531-PE2-903	181584	36531-PT0-N02	181584	36532-PLA-G01	181591
36531-POB-A01	181591	36531-PE2-904	181584	36531-PT2-J02	181590	36532-PLM-A01	181591
36531-P12-A02	181591	36531-PE2-905	181584	36531-PT3-A02	181591	36532-PLR-A01	181591
36531-P12-A03	181591	36531-PE2-906	181584	36531-PT3-A04	181591	36532-PLR-A11	181591
36531-P12-A12	181591	36531-PE7-662	181584	36531-PT3-A05	181591	36532-PMM-A01	181591
36531-P1A-004	181584	36531-PE7-663	181584	36531-PT3-A12	181591	36532-PMP-A01	181590
36531-P1E-J01	181591	36531-PEA-J01	181591	36531-PV0-024	181591	36532-PMS-A01	181591
36531-P1K-E01	181584	36531-PFB-J02	181591	36531-PV0-J12	181591	36532-PNA-004	181591
36531-P1K-E11	181591	36531-PFC-003	181584	36531-PV1-A02	181591	36532-PNC-004	181591
36531-P1R-004	181592	36531-PFD-003	181584	36531-PVF-A01	181590	36532-PND-A01	181590
36531-P1R-A01	181590	36531-PFE-J02	181584	36531-PWA-902	181591	36532-PND-A11	181590
36531-P1R-A02	181590	36531-PFE-N03	181591	36531-PWA-903	181591	36532-PND-A21	181590
36531-P2A-J01	181584	36531-PG7-305	181584	36531-PXH-013	181591	36532-PPA-004	181590
36531-P2A-J02	181584	36531-PG7-315	181584	36531-PY3-003	181590	36532-PPA-A01	181590
36531-P2P-A01	181590	36531-PG7-661	181584	36531-PYD-901	181591	36532-PR7-003	181590
36531-P2Y-G01	181584	36531-PG7-A01	181584	36531-PZ3-N02	181584	36532-PR7-A01	181591
36531-P3F-004	181591	36531-PGE-A11	181590	36531-PZD-A01	181591	36532-PR7-A02	181591
36531-P3F-014	181591	36531-PGK-A03	181590	36531-PZX-A01	181590	36532-PR7-A11	181591
36531-P3F-902	181591	36531-PGM-003	181591	36531-PAA-305	181591	36532-PR7-J01	181591
36531-P3Y-G01	181584	36531-PGM-J51	181591	36531-PAA-A01	181591	36532-PR7-J02	181591

ACCESSORIES

O.E.M. names and numbers are used for reference purposes only.

OE No.	HC-CARGO	OE No.	HC-CARGO	OE No.	HC-CARGO	OE No.	HC-CARGO
HONDA continued							
36532-PRB-A01	181590	37240-657-305	150783	ISUZU			
36532-PRB-A11	181590	37240-657-305	150798	1214321	100657	94841821	150798
36532-PSA-J01	181591	37240-657-305	150815	1-82513043-0	100658	9-81360005	150395
36532-PWA-G01	181591	37240-P13-003	150768	1-82513044-0	100658	9-81360007	150395
36532-PWA-G02	181591	37240-P13-003	150777	5-19679001-0	080001	9-82511535	150395
36532-PWA-J02	181591	37240-P13-003	150783	5-86202813-0	181590	9-82511978-0	100275
36532-PY3-003	181591	37240-P13-003	150815	5-86202814-0	181591	982513508	150395
36532-PYC-J01	181591	37240-P13-004	150768	5862028310	150770	9-82513508-0	150395
36532-PYC-J12	181591	37240-P13-004	150777	5-86205842-0	181590	982513509	150395
36532-PZA-A01	181590	37240-P13-004	150783	5862061610	150885	9-82513509-0	150395
36532-PZA-J01	181590	37240-P13-004	150798	5-86206251-0	181591	9-82513928-0	100658
36532-PZA-L02	181590	37240-P13-004	150815	5862071980	150885	9-82513928-2	100658
36532-PZD-A01	181590	37240-P13-013	150768	8011010380	150619	9-82513928-3	100658
36532-PZX-A01	181590	37240-P13-013	150777	8-01101038-0	150619	9-82513928-4	100658
36532-PAA-A01	181591	37240-P13-013	150783	8-01104038-0	150619	9-82513928-5	100658
36532-PAA-A02	181591	37240-P13-013	150798	8-01979571-0	150063	9-82513928-6	100658
36532-PAA-L01	181591	37240-P13-013	150815	8-08990351-0	181584	9-82513928-7	100658
36532-PAA-L02	181591	37240-P13-014	150777	8-08990741-0	181584	9-82513928-8	100658
36532-PAA-L41	181590	37240-P13-014	150783	8-08990793-0	181585	9-82513928-9	100658
36532-RAD-L11	181590	37240-P13-014	150815	8-10496541-0	150239	9827202092	150764
36532-RAD-L12	181590	37240-P2F-A01	150770	8-12567127-0	181591	9827202092	150768
36532-RCA-A01	181590	37240-P2F-A01	150786	8-12567163-0	181591		150794
36532-RCA-A02	181590	37240P5TG01	150761	8-12573167-0	181590	IVECO	
36532-RCA-A51	181590	37240-PA6-004	150768	8-12573168-0	181591	01287474	090202
36532-RCJ-A01	181590	37240-PA6-004	150777	8-12573721-0	181590	02471298EE	160216
36532-RDJ-A01	181590	37240-PA6-004	150783	8-12577588-0	181591	1164018	160317
36532-RFE-J02	181591	37240-PA6-004	150798	8-12578624-0	181591	1172393	160216
36532-RFE-J52	181591	37240-PA6-004	150815	8-16140049-0	150063	1173764	090020
36532-RGA-014	181591	37240PCX003	150768	8-24576791-0	181584	41040442	160216
36532-RGA-J01	181591	37240PCX003	150777	8-24577303-0	181591	41118038	192902
36532-RJA-004	181590	37240PCX003	150783	8-25105107-0	181584	41801122EE	160769
36532-RKC-014	181591	37240PCX003	150798	8-25105901-0	181584	41822376	160216
36532-RMX-A01	181591	37240PCX003	150815	8-25133185-0	181584	41991420	170936
36532-RNA-A01	181590	37240PD2003	150770	8-25162600-0	181584	42046397	171230
36532-RRR-004	181590	37240PD2003	150786	8-25162693-0	181584	42069397	160394
36532-RTA-004	181591	37240PD2004	150770	8-25162753-0	181584	42096498	160394
36532-RAA-A01	181590	37240PD2004	150786	8-25166816-0	181584	42530143	160216
36532-TEA-A01	181591	37240PI3003	150783	8-87210818-2	100555	42533804	192569
36535-P5A-A01	181591	37240PLZD00	150770	8-92196190	150395	42537930	192586
36535-P5A-A51	181591	37240PLZD00	150786	8-94025866-0	180875	42556816	192569
36535-P5G-A01	181591	37240-PT0-003	150770	8941187550	150770	4448131	180804
36541-PR7-A01	181591	37240-PT0-003	150786	8-94133759-1	100657	4609596	090187
36541-PR7-A31	181591	37240PT0004	150770	8-94133759-2	100657	4648022	090187
36541-PR7-A51	181591	37240PT0004	150786	8-94133759-3	100657	4660069	090187
36542-PR7-A01	181591	37240PT0014	150786	8-94133759-4	100657	4667509	090187
36542-PR7-A51	181591	37240PT0014	150770	8-94133759-5	100657	4709282	090187
36542-RCA-A01	181590	37240PT0014	150786	8-94133759-6	100657	4718222	160216
36542-RDJ-A01	181590	37240PT0023	150770	8-94133759-7	100657	4740717	090187
36542-RJA-004	181590	37240PT0023	150786	8-94140115-3	100657	4756678	090187
37200590036	150768	37500-RBD-E010M5	150451	8-94175158-0	100657	4757883	090187
37200590036	150783	37600611154	150768	8-94175158-1	100657	4802839	080188
37200590036	150798	37600611154	150777	8-94208866-0	180875	4899689	081115
37200657154	150768	37600611154	150783	8-94221719-3	100245	5000287954	160216
37200657154	150777	37600611154	150798	8-94224731-0	150395	5010412449	150468
37200657154	150783	37870-P5T-G00	180875	8-94235627-0	160407	504051082	181495
37240-534-671	180641	37870-PLZ-D00	181395	8-94241449-0	100245	5158609	160216
37240634305	150764	39794-R3L-BG010	161738	8-94241719-3	100245	5946923	160354
37240634305	150768	39794-R3L-G01	161738	8-94255588-0	100245	5963516	181584
37240634305	150777	39794-R3L-G010	161738	8943129400	150770	62190090	090202
37240634305	150783	89702-425-60	181590	8943129400	150786	69500830	161735
37240634305	150798	89728-735-20	181591	8-94319700-1	100292	71445067	090315
37240-634-671	150764	90007-ZE2-003	191545	8-94404544-0	150157	751874	160337
37240-634-671	150768	AJF51-886-1A	181591	8-94408151-0	181584	752785	090202
37240-634-671	150777			8-94481972-0	100426	7612955	150098
37240-634-671	150783	HYUNDAI → KIA		8-94511978-0	100275	7648798	150379
37240-634-671	150798	INTERNATIONAL HARV.		8-97018586-0	181584	764898	150379
37240-634-671	180641	1983420C2	160081	8-97018587-0	181585	79007284	160169
37240-657-003	150768	3031556R91	090076	8-97024256-0	181590	8092471	090315
37240-657-003	150777	711086R92	090016	8-97032102-1	181590	8109522	160081
37240-657-003	150783	712082R92	090015	8-97062292-0	181585	9462703	160424
37240-657-003	150798	712082R93	090015	8-97073641-0	100657	960099	160478
37240-657-003	150815	933696R1	080696	8-97080554-0	100513	97103581	160769
37240-657-013	150768	K850526	090076	8-97240034-1	150451	975301258	150055
37240-657-013	150777			8-97287352-0	181591	98469129	150809
37240-657-013	150783	ISKRA		8973756630	150787	99318040	081040
37240-657-013	150798	60708038	150246	8980130140	150770	99463242	170998
37240-657-013	150815	AEV1401	150055	94841821	150768	99463243	171098
37240-657-305	150768	AEV140112	150055	94841821	150777	99463244	170999
37240-657-305	150777			94841821	150783	9981541	090202

OE No.	HC-CARGO	OE No.	HC-CARGO	OE No.	HC-CARGO	OE No.	HC-CARGO
JAEGER		1176	171953	1501	170346	1742	170592
09477509	180950	1177	170693	1501	170774	1750	171479
31556605	181005	1178	170694	1502	170417	1751	170588
JAGUAR		1179	171039	1502	170795	1752	170589
02JD61604	100622	1181	170496	1510	171491	1761	171139
02JLM21842	160282	1182	170362	1511	170345	1836	170470
02LHF6703AA	160282	1183	171009	1511	171103	1848	170380
27DAC7687	160403	1184	171010	1512	170416	1855	171987
AGU 1108	181584	1186	171034	1512	170796	1896	170741
AGU 1870	181585	1187	171035	1520	171490	1896	171082
AJ83344	150813	1188	171036	1521	170594	1897	170742
C2C 25956	181590	1189	171037	1551	170448	1898	170751
C2C 7360	181590	1191	170493	1551	171119	1899	170752
C2S 38497	181590	1191	171068	1552	170456	1920	171042
C2S11480	150898	1192	170494	1601	170410	1921	171043
C2S30972	150801	1195	170380	1601	170775	1932	171044
C2S41414	150801	1199	170681	1601-AMBER	170782	1950	171040
C2S42664	150813	1200	171477	1601-GREEN	170783	2000	171132
C2S42673	150898	1201	170338	1601-RED	170785	20238	170726
C2S52255	150813	1201	170771	1602	170477	242WO	172170
C2S7928	150898	1202	170350	1602	171108	24338	170509
CAC2263	070053	1211	171985	1603	170617	249CB-WO	172182
CAC4269	070053	1221	171975	1605	171283	252WO	172172
CBC5657	070053	1231	171974	1607	170813	252YO	172173
DAC 2549	181584	1232	171976	1608	170758	260RO	172158
DAC 6907	181585	1241	170575	1609	170755	260WO	172159
DBC 10744	181585	1245	170579	1611	170331	260YO	172157
DBC1140	150545	1248	171991	1611	171104	264RO	172161
DBC1140	150669	1249	171978	1611-AMBER	170778	264WO	172160
ERC 6193	181584	1310	171983	1611-GREEN	170779	264YO	172162
LNA1682AC	181591	1311	171988	1612	170476	265RO	172167
LNE1682BB	181590	1312	171996	1612	171106	265WO	172168
LNE1682BC	181590	1318LL	171979	1612-AMBER	170805	271BO	172180
ULC 1917	181584	1320	171984	1612-GREEN	170806	271RO	172179
XR8 1557	181590	1321	170335	1612-RED	170808	271WO	172181
XR8 2007	181590	1321	170769	1621	170347	27225	170725
XR8 22998	181590	1322	170349	1621	171105	27243	171027
XR8 6938	181590	1322	170826	1622	170542	342WO	172171
XR829087	150813	1326	170451	1622	171107	352RO	172174
		1326	171078	1624	170754	352WO	172175
		1338LL	170659	1628LL	170662	352YO	172176
		1341	170336	1631	170777	360WO	172163
		1341	170770	1632	170776	364RO	172165
		1342	170452	1633	171398	364WO	172164
		1342	171092	1641	170727	364YO	172166
		1345	170644	1641	171109	365WO	172169
		1345	171093	1645	170756	371RO	172177
		1362	171986	1645	171110	371WO	172178
		1365	170816	1646	171033	37755	170664
		1375	171989	1651	170545	50440MPU	171064
		1383	170648	1655	170610	7234	171977
		1383	171089	1661	170357	H4360	H4360
		1385	171994	1662	170358	H5360	H5360
		1390	171998	1665	170611		
		1391	170583	1671	170612		
		1392	171088	1682	170613	JCB	
		1393	170849	1692	170757	324-00701	AS301
		1393	171090	1692	171111	988-00030	AS301
		1400	171981	1695	170753	F8251	AS301
		1401	170340	1695	171112		
		1401	170773	1696	170698	JOHN DEERE	
		1402	170413	1699	171025	001335	171171
		1402	170794	1701	170590	001780	171230
		1406	170455	1705	170591	014372	160216
		1406	171118	1710	171484	014375	190766
		1408LL	171980	1711	170341	106197	171230
		1410	171993	1711	171094	14372	160337
		1411	170339	1712	170414	15730019	160216
		1411	170772	1712	171096	15730019	160337
		1412	170351	1715	170411	57M7182	190766
		1412	170793	1715	171095	59024	160216
		1415	171990	1721	170343	59024	160337
		1416	170454	1721	171097	AL150015	160081
		1416	171076	1722	171099	AL207376	160282
		1417	171997	1731	170344	AL208596	160081
		1418LL	171992	1731	171098	AL25957	190273
		1431	170593	1732	171100	AL29657	160081
		1432	171102	1735	170005	AL32891	160263
		1500	171492	1741	170342	AL55738	190766
						AL61578	160919

ACCESSORIES

O. E. M. names and numbers are used for reference purposes only.

OE No.	HC-CARGO	OE No.	HC-CARGO	OE No.	HC-CARGO	OE No.	HC-CARGO
KUBOTA		570006523	080111	BAE800AK	150246	DS057	100286
15221-65513	100435	570027123	090198	CIM15A	100262	DS058	100303
15451-43560	AS301	571477208	080742	CL101	150395	DS061	100287
15521-65512	100434	6000279	190273	CL102	150917	DS065	100254
15951-65512	100433	6001637	190767	CL74	150395	DS068	100271
16096-14233	150451	6002153	160337	CL75	150917	DS082	100331
16241-65511	100523	6003311	180399	DAB118	150072	DS095	100616
16261-65511	100523	607108808	171230	DAB125	150058	DS095A	100616
16604-05230	090333	6071106	160199	DAB126	150175	DS101	100079
16616-60011	090216	607110608	160199	DAB129	150072	DS122	100511
16851-65512	100518	607126601	171230	DAB134	150175	DSC02	160424
19077-65510	100524	607128301	170936	DAB200	150055	DSC18	160417
19844-52031	090333	6200082	160337	DAB201	150055	DX1A	100511
3518110	160311	6200906	160337	DAB400	150056	ELBX149	170413
70000-14632	AS301	6200907	190766	DAB401	150057	ELBX150	171102
MDF44-7	090253	6202284	190766	DAB402	150075	ELBX207	170773
W2700-05746	171171	6202511	160337	DAB404	150154	ELBX233	170774
KÄSSBOHRER		630105408	160337	DAB405	150098	ELBX241	170349
7.375.125.000.0	160216	6301203	160308	DAB700	150062	ELBX245	170772
7375112000	160266	630120308	160308	DAB702	150064	ELBX246	170793
73751250000	160337	630121008	160266	DAB752	150067	ELBX249	170795
737515000	160443	630121508	160216	DAB800	150088	ELBX286	170775
73751591000	160441	6301228	160337	DAB801	150165	ELBX380	170770
83119997110	090076	630122808	160337	DAJ204	150068	ELBX382	170335
8311999717	090076	6301229	190766	DAJ902	150157	ELBX395	171975
LADA		630122908	190766	DAJ904	150236	ELBX434	171082
2100000000000	150809	630122990	190766	DLB101	150395	ELBX453	170333
21013705000	150395	6301423	160215	DLB102	150917	ELBX460	170836
21013705000	150531	630142314	160215	DLB105	150395	ELBX472	171066
2101-3705000	150395	630160214	160216	DLB110	150917	ELBX475	170348
2101-3705000	150531	630160805	160216	DLB314	150246	ELBX477	171077
21013705060	150395	630191801	190766	DLB800	150612	ELBX501	171105
21013705060	150531	6905206	171230	DMB1065	150630	ELBX501A	171123
21013705060	150395	7006439	080575	DMB1066	150639	ELBX505	171106
21013705060	150531	7006472	080692	DMB1120	150911	ELBX507	171106
2101-3705060	150395	7360197	090076	DMB1155	150649	ELBX508	171095
2101-3705060	150531	7381047	081115	DMB1158	150646	ELBX508T	170358
2101-3808600	180804	900002423	160365	DMB2003	150904	ELBX580	170776
2103-3808800	181001	900003244	160403	DMB2018	150902	ELBX581	171089
21063829010	150796	900003475	160337	DMB2033	150886	ELBX588	171090
21083705010	150543	LUCAS		DMB2070	150629	ELBX921	171403
2108-3705010	150543	11P12	150395	DMB2072	150626	ELBXD2R	171132
2108370501006	150543	190725	190725	DMB2078	150672	ELBXD2S	171133
2108373491010	150056	190726	190726	DMB2079	150889	FDB501	160352
2110000000000	150543	192404	192404	DMB2082	150610	FDB502	160350
2110000000000	150606	30972	181183	DMB2092	150618	FDB504	160295
2110000000000	150796	31P6	150917	DMB866	150653	FDB505	160353
2110000000000	150572	34228	181235	DMB880	150633	FDB506	160354
21113705010	150572	34542	180790	DMB883	150899	FDB508	160372
2111-3705010	150572	35630	181236	DMB894	150621	FDB510	160374
21120-3705010-10	150606	35631	181183	DMB915	150888	FDB511	160375
2112-3705010-01	150572	35670	181235	DMB939	150650	FDM644	181500
2112-3705010-02	150572	36614	181237	DMB940	150625	HDC101	160423
2112-3705010-05	150572	38890B	181183	DMB95	150617	HDC102	160424
2112-3705010-10	150572	45289	150395	DS001	100511	HDC103	160425
2112-3705010-13	150572	45290	150917	DS002	100511	HDC104	160420
2113-3705010	150572	45291	150395	DS003	100511	HDC105	160418
2121374721000	160081	45294	150917	DS004	100512	HDC108	160416
363734	150056	54134027	192228	DS005	100086	HDC111	160419
46013705	150572	54142360	191287	DS006	100511	HDC113	160417
LAMBORGHINI		54324157	181465	DS007	100303	HDC114	160458
245195200	090016	54403549(2)	150055	DS008	100512	HDC116	160441
LANCIA → FIAT		54403575(2)	150055	DS010	100262	HDC117	160443
LAND ROVER → ROVER GROUP		54960402	132804	DS012	100263	HDC118	160442
LIEBHERR		54987086	150175	DS017	100246	HDC122	160426
10197021	160270	60600983	132804	DS018	100256	HDC124	160438
104400031	190766	7111/296	AS301	DS019	100260	HDC125	160436
104400164	160919	80334A	150175	DS020	100258	HDC126	160434
11181810	160215	80334A	150380	DS022	100282	HDC127	160421
11181810	160978	84403	150072	DS023	100280	HDC128	160469
11839818	160919	84403D	150072	DS024	100251	HDS124	100258
510657608	090076	84890D	150175	DS025	100252	HDS216	100511
510657677	090076	84896A	150072	DS026	100261	HDS217	100511
5121002	080793	8490D	150175	DS028	100247	HDS218	100511
		84950	150072	DS032	100245	HDS219	100512
		84950A	150072	DS034	100275	HDS220	100086
		84972	150072	DS047	100256	HDS221	100511
		9490D	150380	DS052	100284	HDS222	100303
				DS056	100303	HDS223	100512

ACCESSORIES

O. E. M. names and numbers are used for reference purposes only.

OE No.	HC-CARGO	OE No.	HC-CARGO	OE No.	HC-CARGO	OE No.	HC-CARGO
LUCAS continued							
HDS225	100263	LLB286	170410	LLB472HD	170334	LLB880P	171009
HDS226	100566	LLB286A	170782	LLB472P	170334	LLB881	171010
HDS227	100263	LLB286AP	170782	LLB472PR	170334	LLB881P	171010
HDS232	100246	LLB286AT	170782	LLB475P	170348	LLB9005	171804
HDS233	100257	LLB286G	170783	LLB475PR	170348	LLB9005P	171804
HDS234	100260	LLB286GP	170783	LLB475R	170009	LLB9005XS	171804
HDS235	100258	LLB286GT	170783	LLB475RS	170513	LLB9006	171794
HDS237	100282	LLB286-MFH/ZT	171382	LLB477	170720	LLB9006P	171794
HDS238	100280	LLB286-MFHZ	171382	LLB483	170496	LLB9006XS	171794
HDS239	100251	LLB286PX2	170410	LLB483P	170496	LLB9008	171796
HDS240	100252	LLB286R	170785	LLB484	171065	LLB921	171403
HDS241	100261	LLB286RP	170785	LLB484P	171065	LLB921A	171402
HDS243	100247	LLB286T	170410	LLB484R	170009	LLB921T	171403
HDS245	100256	LLB286TAC	170357	LLB485	170359	LLD2R	171132
HDS247	100243	LLB286-TACP	170357	LLB485P	170359	LLD2S	171133
HDS249	100275	LLB286-TACT	170357	LLB489	171405	LLD3S	171712
HDS262	100256	LLB286TB1	171284	LLB4896	171411	LLD4R	171711
HDS266	100284	LLB286-TB1T	171284	LLB489P	171405	LLX472-BL50	170802
HDS267	100284	LLB286TFB	171112	LLB490P	170513	LLX472BL50X2	170009
HDS271	100303	LLB286-TFBT	171112	LLB492	170512	OPS101	180649
HDS272	100286	LLB286TFT	171384	LLB495	170362	OPS103	180649
HDS273	100303	LLB286-TFTT	171384	LLB501	170347	OPS104	180649
HDS276	100287	LLB286TG	170545	LLB501A	170754	OPS110	180634
HDS280	100254	LLB286TGT	170545	LLB501AP	170754	OPS112	180631
HDS283	100271	LLB286THB	170727	LLB501AT	170754	OPS113	180631
HDS297	100331	LLB286-THBP	170727	LLB501BLT	171122	OPS114	150796
HDS306	100548	LLB286-THBT	170727	LLB501-BPX2	171122	SEB414	150354
HDS316	100079	LLB286THP	170610	LLB501PX2	170331	SEB453	150470
HDS337	100511	LLB286-THPP	170610	LLB501T	170347	SEB485	150468
HDS340	100276	LLB286-THPT	170610	LLB504	170331	SFB165	160314
HDS341	100512	LLB286TVP	171455	LLB504P	170331	SMB406	180009
HDS342	100511	LLB286TVT	171455	LLB504T	170331	SMB412	180731
HDS343	100512	LLB286TVW	170612	LLB505	170805	SMB418	180734
HDS345	100292	LLB286-TVWP	170612	LLB505P	170805	SMB423	180790
HDS346	100426	LLB286-TVWT	170612	LLB505T	170805	SMB511	181191
HDS349	100511	LLB286TW	170611	LLB507	170542	SMB512	181182
HDS350	100335	LLB286TWT	170611	LLB507P	170542	SMB526	181201
HDS352	100331	LLB287	171491	LLB507T	170542	SMB528	181212
HDS353	100511	LLB288	170345	LLB508	170477	SMB531	181194
HDS354	100339	LLB288T	170345	LLB508EBSN10	171377	SMB539	180785
HDS355	100323	LLB289	170416	LLB508G	170477	SNB116	180839
HDS356	100534	LLB289T	170345	LLB508T	170477	SNB150	180950
HDS358	100306	LLB290	170349	LLB508TAC	170358	SNB171	180848
LLB024	170006	LLB290T	170349	LLB508-TACP	170358	SNB606	180959
LLB024-HBRS	170515	LLB293	171492	LLB508-TACT	170358	SNB618	180985
LLB0452P	170694	LLB294	170452	LLB508TB1	171284	SNB701	180954
LLB1046	170718	LLB294T	170452	LLB508TGY	170613	SNB702	180953
LLB149	170413	LLB298	170816	LLB508-TGYT	170613	SNB703	180945
LLB149-LLP/X2	170413	LLB343	170335	LLB567	170850	SNB708	180949
LLB149P	170413	LLB343P	171091	LLB567T	170850	SNB713	181015
LLB149T	170413	LLB343T	171091	LLB580	170776	SNB714	181005
LLB180	170710	LLB380	170336	LLB580P	170776	SNB718	181008
LLB180P	170710	LLB380PX2	170336	LLB580T	170776	SNB723	181001
LLB180T	170710	LLB380T	170336	LLB581	170648	SNB727	181009
LLB187A	171869	LLB382	170335	LLB581PX2	170648	SNB730	181021
LLB207	170773	LLB382PX2	170335	LLB581T	170648	SNB746	181064
LLB207PX2	170773	LLB382T	170335	LLB582	170777	SNB756	181088
LLB207S	170773	LLB384	171476	LLB582A	171398	SNB768	181121
LLB207T	170773	LLB384T	171476	LLB582AP	171398	SNB785	181034
LLB209	170593	LLB394	171985	LLB582AT	171398	SNB792	181076
LLB209PX2	170593	LLB395	171975	LLB582P	170777	SNB793	181077
LLB209T	170593	LLB410	170338	LLB582T	170777	SNB809	180875
LLB241	170349	LLB410P	170338	LLB588	170849	SNB814	180861
LLB241P	170349	LLB423	171477	LLB588T	170849	SOB101	180649
LLB241T	170349	LLB429	170350	LLB641	171490	SOB103	180649
LLB245	170339	LLB434	170741	LLB700	170752	SOB104	180649
LLB245PX2	170339	LLB434P	170741	LLB700A	170751	SOB500	180634
LLB245S	171402	LLB442	171407	LLB700AP	170751	SOB501	180634
LLB245T	170339	LLB453	171687	LLB708	171034	SOB502	180634
LLB246	170351	LLB453P	170333	LLB708P	171009	SOB503	180658
LLB246HD	170351	LLB453PR	171687	LLB709	171035	SOB507	180635
LLB246T	170351	LLB455	171469	LLB709P	171035	SOB600	180631
LLB249	170417	LLB4598	171408	LLB710	171036	SOB601	180631
LLB249T	170417	LLB460	170412	LLB711	171037	SOB606	150761
LLB281	170448	LLB460P	170412	LLB711P	171037	SOB704	150796
LLB281P	170448	LLB460PR	170412	LLB713	171796	SOB708	150784
LLB281T	170448	LLB466	170449	LLB775	170800	SOB709	150762
LLB283	170456	LLB466P	170449	LLB784	170837	SOB710	150775
LLB283T	170456	LLB472	170334	LLB880	171009	SOB711	150759

OE No.	HC-CARGO	OE No.	HC-CARGO	OE No.	HC-CARGO	OE No.	HC-CARGO
SOB802.....	180636	607054409.....	150891	MAN		0483-24-921.....	150395
SOB804.....	150770	60705601.....	150612	36259020007.....	160337	0512-18-100.....	150395
SOB805.....	150815	60705604.....	150612	51.98701-0118.....	081115	0522-18-100.....	150395
SOB806.....	150794	60705604010.....	150612	51259190016.....	150557	0710-18-100.....	150395
SOB807.....	180641	60708038.....	150246	81.25229-6051.....	170968	0710-18-100B.....	150395
SOB822.....	150802	60708038010.....	150246	81.25435.0040.....	180399	081318100.....	150917
SOB823.....	150804	60708046010.....	150246	81.25475-0152.....	192902	082018100.....	150917
SOB834.....	150799	60780002010.....	150246	81.25902.0102.....	160216	082318100.....	150917
SOB908.....	150779	64822032.....	150056	81.25902.0109.....	160169	082318100A.....	150917
SOB930.....	150797	64833010.....	150058	81.25902.0110.....	160168	084518101.....	150917
SOB991.....	150769	64833020.....	150055	81.25902.0111.....	160081	086618100A.....	150917
SOB992.....	150760	64833031.....	150165	81.25902.0130.....	160216	086618501A.....	150777
SOB999.....	150773	64833031010.....	150165	81.25902.0171.....	160337	086618501A.....	150794
SPB400.....	180790	648330311010.....	150165	81.25902.0238.....	160081	OK2AB-18-861.....	181588
SRB525.....	160308	64833036.....	150165	81.25902.0248.....	160337	1345-18-501.....	150768
SRB528.....	160168	64833040.....	150088	81.25902.0250.....	160216	1345-18-501.....	150777
SRB701.....	160364	64833040010.....	150088	81.25902.0250.....	160337	1345-18-501.....	150783
SSB100.....	181476	64833060.....	150057	81.25902.0446.....	160265	1345-18-501.....	150798
SSB101.....	181476	64833060010.....	150057	81.25902.0461.....	160216	1345-18-501.....	180641
T1W6A.....	100086	64833100.....	150057	81.25902.0474.....	160337	156218100.....	150917
TIX1A.....	100512	64833100010.....	150057	81.25902-0102.....	160317	156218100A.....	150917
TIX2A.....	100511	64833131.....	150165	81.25902-0155.....	160769	167218100.....	150917
TIX4A.....	100511	940000000000.....	150403	81.25902-0264.....	161035	167218100A.....	150917
TIX6A.....	100511	940000000000.....	150435	81.25902-0317.....	161035	1689-18-100.....	150395
UX1A.....	100086	940038500.....	150056	81.25902-0363.....	161035	1744-18-100.....	150395
UX2A.....	100511	940038501.....	150055	81.25902-0425.....	161035	1744-18-100A.....	150395
UX4A.....	100511	940038502.....	150057	81.25902-0452.....	161035	1A01-18-861.....	181584
UX7A.....	100284	940038503.....	150075	81.25902-0460.....	160317	1A02-13-210A.....	181591
UX8A.....	100512	940038506.....	150154	81.25902-0474.....	160394	1A02-18-861.....	181591
UX9A.....	100511	940038520.....	150062	81.25902-0491.....	161035	1A02-18-861A.....	181591
UXA2.....	100511	940038522.....	150064	81.25902-0519.....	161035	1A06-18-861A.....	181591
		940038526.....	150063	81.25902-0520.....	161035	1A08-18-861.....	181590
MAGNETI MARELLI		940038528.....	150403	81254350045.....	190767	1A08-18-861A.....	181590
060705409010.....	150891	940038530.....	150435	81254350888.....	190766	1A10-18-861.....	181591
060708038010.....	150246	940038540.....	150067	81259020017.....	160266	1A16-18-861.....	181591
062500300304.....	100650	940038544.....	150072	81259020102.....	160216	1A17-18-861.....	181591
062900011304.....	100639	940038550.....	150236	81259020199.....	160216	1E00-18-501.....	150785
062900030304.....	100642	940038603.....	150075	81259020436.....	160216	1E00-18-501.....	180636
064342204010.....	160671	940138501.....	150055	81259020461.....	160216	1E00-18-501A.....	150785
064342210010.....	160671	940385521.....	150058	81259020474.....	160266	1E00-18-501A.....	180636
064833010010.....	150058	943251408010.....	150056	81619300055.....	161719	1E031810X.....	150416
064833020010.....	150055	9940096.....	150088	88.25902.0005.....	160216	1E031810XA.....	150416
064833031010.....	150165	BAE403B.....	150903	88255036011.....	150809	1E04-18-10X.....	150416
064833032010.....	150056	BAE403C.....	150609	88259026005.....	160216	1E04-18-760.....	180893
064833036010.....	150165	BAE50.....	150612			1E04-18-760A.....	180893
064833040.....	150088	BAE504L.....	150891	MANN		1E0518100B.....	150416
064833100010.....	150057	BAE506A.....	150612	P917X.....	AS301	1F2018100.....	150416
07029585.....	100511	BAE506C.....	150612	WK31/4.....	RT2002	22218501.....	150815
0940038506.....	150154	BAE506D.....	150612			22318501.....	150777
0940038522.....	150064	BAE506G.....	150612	MASSEY FERGUSON		269118501A.....	150768
0940038526.....	150063	BAE800AK.....	150246	2868360M1.....	090016	269118501A.....	150794
0940038540.....	150067	BAE800B.....	150246	3141063M2.....	160263	2851-18-100A.....	150395
0941038520.....	150062	BAE800DK.....	150246	3387326M2.....	160311	29018100.....	150395
111000000000.....	150354	BAK506C.....	150612	3615652M1.....	160081	3607-18-100.....	150395
116000000000.....	150805	BI0021MM.....	150505	4270844M1.....	160282	3607-18-100A.....	150395
116459169917.....	180631	BI0037MM.....	150508	4272431M1.....	160919	364818101.....	150917
116459169925.....	180631	BKL1A.....	150058	4272432M1.....	160403	364818101A.....	150917
116580459904.....	180945	BKL2A.....	150055			395824920.....	150917
116580679904.....	181021	BKL3B.....	150165	MATSUSHITA		3F01-18-251.....	150160
116580729901.....	181001	BKL3BD.....	150165	192145.....	192145	71018100.....	150395
116580729908.....	181009	BKL3C.....	150056			81318501.....	150777
116580729913.....	181005	BKL4A.....	150088	MAZDA		81318501.....	150815
116580739902.....	181009	MTR01.....	150055	0222-18-100A.....	150395	8174-24-910.....	150068
116580739927.....	181005	MTR02.....	150057	0222-18-501A.....	150768	855318100.....	150917
116596409901.....	180804	MTR03.....	150098	0222-18-501A.....	150777	8574-24-910.....	150068
172000000000.....	150805	MTR2.....	150057	0222-18-501A.....	150783	8601-18-861.....	181584
210843.....	210843	RBIO092MM.....	150508	0222-18-501A.....	150798	86618501.....	150777
210873.....	210873	REP1A.....	160423	0222-18-501A.....	150815	887118100.....	150917
210948.....	210948	SAA013.....	150805	0222-18-501A.....	150815	887124920.....	150917
34542.....	180790	SAA101.....	150805	022298501A.....	150777	AJ03-18-861D.....	181590
410782000800.....	100352	SAA105.....	150760	0258-00-2035.....	181584	AJ51-18-861.....	181590
510000000000.....	150760	MAGNETON (PAL/SKODA)		0290-18-100.....	150395	AJ51-18-8619U.....	181590
510000000000.....	150809	210843.....	210843	0294-18-100.....	150395	AJ52-18-861.....	181591
54403549.....	150055	210948.....	210948	0324-18-100.....	150395	AJ52-18-861A.....	181591
54403575.....	150055	443213221020.....	150215	0381-18-100.....	150395	AJ52-18-861A9U.....	181591
581701010000.....	150165	852018.....	180634	0419-18-100.....	150395	AJ53-18-861A.....	181590
581701020000.....	150165	852076.....	180634	0453-18-100.....	150395	AJ53-18-861A9U.....	181590
581701070000.....	150088	TZP443213221020.....	150215	0483-18-100B.....	150395	AJ57-18-861A.....	181590
581701080000.....	150057			0483-18-100C.....	150395	AJ57-18-861B.....	181590

ACCESSORIES

O.E.M. names and numbers are used for reference purposes only.

OE No.	HC-CARGO	OE No.	HC-CARGO	OE No.	HC-CARGO	OE No.	HC-CARGO
MAZDA continued							
AJ59-18-861B	181590	BPE8-18-861A9U	181591	FSE1-18-861B	181591	KL62-18-861A	181590
AJ59-18-861C	181590	BPS1-18-861	181591	G609-18-861	181584	KL62-18-861A9U	181590
AJ60-18-861A	181590	BPS1-18-862B	181591	GY0118501	150813	KLA6-18-861	181590
AJ60-18-861B	181590	C20118100A	150416	GY0118501A	150813	KLA6-18-861A	181590
AJ95-18-861	181590	C20118100B	150416	GY01-18-861A	181590	KLA7-18-861	181590
AJ95-18-8619U	181590	C201-18-861	181591	GY01-18-861A9U	181590	KLA7-18-861A	181590
AJC118501	150813	C601-18-861	181591	GY0218501	150813	KLC4-18-861A	181590
AM15-18-861	181584	D410-18-100A	150395	GY02-18-861B	181591	KLC7-18-861	181589
AM15-18-V20	150096	E35618100	150917	GY02-18-861B9U	181591	KLC7-18-861A	181589
AM30-18-861	181584	E356-18-100	150539	GY03-18-861A	181590	KLC7-18-861B	181589
AM30-18-8619U	181584	E35718100	150917	GY03-18-861B	181590	KLC7-18-861B9U	181589
B303-18-861B	181584	E357-18-100	150532	GY03-18-861B9U	181590	KLC8-18-861	181590
B303-18-V20	150417	E50318501	150768	GY04-18-861	181591	KLC8-18-861A	181590
B31R-18-861A	181585	E563-18-861	181584	GY04-18-861B	181591	KLC8-18-861A9U	181590
B359-18-861	181584	E564-18-861	181584	GY04-18-861B9U	181591	KLD4-18-861	181590
B365-18-501	180641	E565-18-861	181584	GY05-18-861	181591	KLD4-18-861A	181590
B366-18-501	150764	E5D318501	150768	GY05-18-861A	181591	KLD4-18-861A9U	181590
B366-18-501	150768	E5D318501	150794	GY05-18-861A9U	181591	KLD8-18-861	181589
B366-18-501	150777	E5D318510	150794	GY06-18-861	181591	KLD8-18-8619U	181589
B366-18-501	150783	E663-18-861	181584	GY06-18-861A	181591	KLG4-18-861	181590
B366-18-501	150798	E730-12-4910	150096	GY06-18-861A9U	181591	KLG4-18-861A	181590
B366-18-501	180641	F201-18-861	181584	HE0318100	150917	KLJ9-18-861A	181590
B367-18-501	150777	F201-18-861A	181584	JE081-88-61B	181587	KLJ9-18-861B	181590
B367-18-501	180641	F201-18-861A9U	181584	JE08-18-861B	181586	KLJ9-18-861D	181590
B376-18-861	181584	F287-18-861	181584	JE46-18-86Z	181584	KLL5-18-861	181590
B3C7-18-861A	181585	F80118100B	150917	JE48-18-861	181590	KLL5-18-861B	181590
B541-18-V20	150234	F801-18-100B	150917	JE48-18-861A	181590	KLL5-18-861B9U	181590
B564-18-861	181584	F829-18-V20	150160	JE48-18-861A9U	181590	KLL6-18-861	181590
B5E1-18-861B	181590	F8G8-18-8619U	181584	JE49-18-861A	181590	KLL6-18-861A	181590
B5F3-18-861A	181590	FE05-18-861	181584	JE50-18-861	181590	KLL6-18-861B	181590
B601-18-861	181584	FE86-18-861	181584	JE50-18-861A	181590	KLL6-18-861C	181590
B61R-18-861	181584	FE86-18-861A	181584	JE50-18-861B	181590	KLL8-18-861	181590
B61R-18-861A	181584	FE86-18-861B	181584	JE96-18-861	181591	KLL8-18-861A	181590
B61R-18-861A9U	181584	FE86-18-861B9U	181584	JE96-18-861A	181591	KLL8-18-861A9U	181590
B61R-18-861B	181584	FEFB-18-V20	150160	JE96-18-861A9U	181591	KLL9-18-861	181590
B61Z-18-861A	181584	FEH1-18-861	181584	JE97-18-861	181590	KLL9-18-861A	181590
B6A7-18-861	181584	FEH1-18-8619U	181584	JE97-18-861A	181590	KLL9-18-861A9U	181590
B6B1-18-861	181584	FEJK18501	150764	JE97-18-861A9U	181590	KLM6-18-861	181590
B6B1-18-8619U	181584	FEJK18501	150768	JE99-18-86Z	181591	KLM7-18-861	181591
B6B3-18-861	181584	FEJK18501	150794	JE99-18-86Z9U	181591	KLS2-18-861	181590
B6B3-18-861A	181584	FP33-18-861B	181590	JF01-18-251	150160	KLS2-18-861A	181590
B6DC-18-861	181585	FP35-18-861B	181590	JF0118501	150764	KLS2-18-861B	181590
B6DC-18-861A	181585	FP49-18-861	181591	JF0118501	150768	KLS3-18-861	181590
BEH1-18-861	181584	FP49-18-8619U	181591	JF0118501	150794	KLS3-18-861A	181590
BP03-18-861	181584	FP50-18-861	181591	K802-18-861C	181590	KLS3-18-861B	181590
BP03-18-861A	181584	FP50-18-861A	181591	K805-18-861A9U	181591	KLS6-18-861	181590
BP03-18-861B	181584	FP50-18-861A9U	181591	K806-18-861A	181591	KLS6-18-861A	181590
BP03-18-861B9U	181584	FS1118501	150768	K806-18-861A9U	181591	KLS7-18-861	181590
BP3A-18-861	181591	FS1118501A	150783	KF33-18-861A	181590	KLS7-18-861A	181590
BP3A-18-8619U	181591	FS111850X	150783	KF34-18-861A	181590	L321-18-861A	181590
BP3B-18-861	181591	FS1G-18-861	181591	KF34-18-861B	181590	L321-18-861B	181590
BP3B-18-86Z	181591	FS1G-18-861A	181591	KJ01-18-861	181585	L334-18-861A	181590
BP3B-18-86Z9U	181591	FS1H-18-861	181591	KJ01-18-861A	181585	L334-18-861B	181590
BP3C-18-8619U	181591	FS1H-18-861A	181591	KJ01-18-861A9U	181585	L336-18-861	181591
BP3D-18-861	181591	FS1J-18-861	181590	KJ02-18-861A	181585	L363-18-861A	181591
BP3D-18-8619U	181591	FS1J-18-861A	181590	KJ02-18-861B	181585	L364-18-861	181591
BP4W-18-861B	181591	FS1K-18-861	181591	KJ02-18-861C	181585	L395-18-8G1	181591
BP4X-18-861	181591	FS1K-18-861A	181591	KJ02-18-861C9U	181585	L3A1-18-861A	181591
BP4X-18-861A	181591	FS2V-18-861A	181590	KJ03-18-861	181590	L3A1-18-861A9U	181591
BP4X-18-861A9U	181591	FS2V-18-861B9U	181590	KJ03-18-861B	181590	LF0118100	150416
BP4Y-18-861A	181591	FS7N-18-861	181590	KJ03-18-861B9U	181590	LF16-18-100	150637
BP4Y-18-861C	181591	FS7N-18-8619U	181590	KJ04-18-861	181590	LF16-18-100A	150637
BP4Y-18-861C9U	181591	FS8B-18-861A	181591	KJ04-18-861A	181590	LF16-18-100B	150637
BP6F-18-861	181590	FSAX-18-861	181591	KJ04-18-861B	181590	LF17-18-861C	181591
BP6F-18-861B	181590	FSAX-18-861U	181591	KJ04-18-861B9U	181590	LF66-18-861A	181590
BP6F-18-861B9U	181590	FSC1-18-861	181590	KJ04-18-861C	181590	LF66-18-861B	181590
BP6G-18-861	181591	FSC1-18-861A	181590	KJ04-18-861C9U	181590	LF66-18-861B9U	181590
BP6G-18-861C	181591	FSC1-18-861B	181586	KL1C-18-861	181590	LF67-18-861A	181591
BP6G-18-861C9U	181591	FSC1-18-861B9U	181590	KL1C-18-8619U	181590	LF68-18-861B	181591
BPD3-18-861A9U	181591	FSC5-18-861	181585	KL1D-18-861	181590	LF68-18-861B9U	181591
BPD3-18-891A9U	181591	FSC5-18-861A	181585	KL1D-18-8619U	181590	LF69-18-861A	181591
BPD4-18-861	181591	FSC5-18-861A9U	181585	KL1E-18-861	181590	LF69-18-861B	181591
BPD4-18-861A	181591	FSC6-18-861	181590	KL1E-18-861A	181590	LF69-18-861C	181591
BPD4-18-861A9U	181591	FSC6-18-861A	181590	KL1E-18-861A9U	181590	LF69-18-861D	181591
BPE1-18-861	181590	FSC6-18-861A9U	181590	KL47-18-861	181590	N304-18-861	181584
BPE1-18-861A	181590	FSD-71-8100	150416	KL47-18-861A	181590	N326-18-861	181584
BPE1-18-861A9U	181590	FSD7-18-861A	181590	KL47-18-861B	181590	N3A1-18-861	181584
BPE8-18-861	181591	FSE1-18-861	181591	KL61-18-861A9U	181590	N3A1-18-861A9U	181584
BPE8-18-861A	181591	FSE1-18-861A	181591	KL62-18-861	181590	N3H3-18-861A	181591

OE No.	HC-CARGO	OE No.	HC-CARGO	OE No.	HC-CARGO	OE No.	HC-CARGO
N3H3-18-861B.....	181591	000 540 75 17.....	181588	0008261741.....	171230	0015407017.....	181592
N3H3-18-861B9U.....	181591	000 540 76 17.....	181588	0008352285.....	261323	0015407117.....	181592
O370-18-100.....	150395	000 540 81 17.....	181588	0008601326.....	160197	0015407317.....	181592
PE01-18-501.....	150808	000 540 82 17.....	181586	0008602026.....	160197	0015407417.....	181592
PE01-18-501A.....	150808	000 540 83 17.....	181586	0008603326.....	160197	0015407517.....	181592
PE0118501B.....	150808	000 540 85 17.....	181588	0008603526.....	160197	0015407617.....	181592
R207-18-501.....	150768	000 540 86 17.....	181586	0009908330.....	192569	0015407917.....	181591
R207-18-501.....	150777	000 540 89 17.....	181588	001 540 01 17.....	181588	0015408017.....	181592
R207-18-501.....	150783	000 540 90 17.....	181588	001 540 04 17.....	181590	0015408517.....	181592
R207-18-501.....	150798	000 540 91 17.....	181588	001 540 05 17.....	181592	0015408717.....	181592
R207-18-501.....	150815	000 540 95 17.....	181590	001 540 07 17.....	181592	0015409217.....	181592
R207-18-5010.....	150815	000 540 96 17.....	181588	001 540 08 17.....	181588	0015409517.....	181591
REN1-18-601.....	100515	000 540 97 17.....	181588	001 540 10 17.....	181588	0015425619.....	160266
RFG1-18-601.....	100515	000 640 96 17.....	181588	001 540 11 17.....	181588	0015440692.....	171230
RFR1-18-601.....	100515	0000005717.....	190766	001 540 12 17.....	181588	0015454714.....	181197
RFS5-18-601.....	100668	0000910001.....	090016	001 540 13 17.....	181586	0015455405.....	160394
RFS5-18-601A.....	100668	0000918401.....	090016	001 540 28 17.....	181588	0015455605.....	160466
S501-18-140.....	100261	0000918501.....	090016	001 540 37 17.....	181592	0015458214.....	181197
S501-18-140A.....	100261	0000919401.....	090016	001 540 38 17.....	181592	0015458632.....	150154
TA34-18-861A.....	181590	0000927901.....	090076	001 540 46 17.....	181592	0015459732.....	160441
U20218501.....	150801	0000941048.....	181500	001 540 47 17.....	181592	0015459832.....	160443
WL03-18-601.....	100520	0000980565.....	080696	001 540 50 17.....	181592	0018300308.....	161719
WLO1-18-601.....	100515	0001501580.....	150625	001 540 51 17.....	181592	0018305608.....	160631
WLO3-18-601.....	100515	0001502980.....	150625	001 540 60 17.....	181592	0018305608.....	261323
Y404-18-601A.....	100663	0001580003.....	150395	001 540 70 17.....	181592	0018305708.....	261325
Y701-18-601.....	100513	0001582603.....	150917	001 540 71 17.....	181592	0018351364.....	070206
YF09-18-10X.....	150416	0001583703.....	150917	001 540 73 17.....	181592	0018354106.....	160081
YF09-18-501.....	150801	0001583803.....	150395	001 540 74 17.....	181592	002 540 01 17.....	181591
Z501-18-861.....	181590	0001584903.....	150917	001 540 75 17.....	181592	002 540 06 17.....	181591
Z501-18-861A.....	181590	0001586103.....	150551	001 540 76 17.....	181592	002 540 08 17.....	181591
Z501-18-861A9U.....	181590	0001586103.....	150915	001 540 79 17.....	181591	002 542 12 18.....	181584
Z553-18-861.....	181590	0001586403.....	150914	001 540 80 17.....	181592	0020913101.....	090016
Z553-18-861A.....	181590	0001587003.....	150424	001 540 85 17.....	181592	0020916001.....	090015
Z553-18-861A9U.....	181590	0001587103.....	150424	001 540 87 17.....	181592	0020917201.....	090020
ZJ0118100.....	150916	0001587203.....	150561	001 540 92 17.....	181592	0025400117.....	181591
ZJ01-18-100.....	150916	0001587303.....	150557	001 540 95 17.....	181591	0025400617.....	181591
ZJ0118100A.....	150916	0001587503.....	150424	0010174912.....	100352	0025400817.....	181591
ZJ01-18-100A.....	150916	0001587503.....	150578	0010910401.....	090016	0025421119.....	160365
ZJ20-18-100.....	150610	0001587803.....	150557	0010911101.....	090202	0025421218.....	181584
ZJ20-18-100A.....	150610	0001590001.....	100331	0010911201.....	090016	0025421419.....	160403
ZL27-18-861A.....	181590	0001592501.....	100079	0010911501.....	090015	0025422719.....	160366
ZM01-18-861.....	181591	0001592601.....	100079	0010911601.....	090016	0025422819.....	160366
ZM01-18-861A9U.....	181591	0001596001.....	100079	0010912701.....	090015	0025423019.....	160366
ZM02-18-861.....	181591	0001596101.....	100079	0010916301.....	090202	0025424232.....	160442
ZM02-18-861A.....	181591	0001597501.....	100511	0010916401.....	090016	0025424332.....	160442
ZM02-18-861A9U.....	181591	0001597701.....	100511	0010916701.....	090020	0025445503.....	171306
ZM03-18-861A9U.....	181590	0001598101.....	100511	0010917301.....	090015	0025450005.....	160169
ZM40-18-861B.....	181591	0001598301.....	100511	0010917801.....	090020	0025450532.....	160441
ZZC018501.....	150813	0001599101.....	100295	0011590001.....	100331	0025450632.....	160443
ZZCA-18-100.....	150637	0001599601.....	100511	0011591501.....	100327	0025451119.....	160365
ZZM3-18-860.....	181590	0001599901.....	100511	0011591601.....	100339	0025451832.....	150154
ZZME-18-861.....	181590	0003043V002.....	150812	0011591701.....	100331	0025451905.....	160470
ZZMF-18-861.....	181590	0003043V002000000.....	150812	0011592001.....	100339	0025452005.....	160470
ZZP1-18-861.....	181591	0004770002.....	090076	0011592101.....	100339	0025452105.....	160470
ZZR1-18-861.....	181591	0005402417.....	181586	0011592601.....	100337	0025452419.....	160216
		0005402617.....	181586	0011592801.....	100537	0025452632.....	150154
		0005402717.....	181586	0011593501.....	100511	0025454032.....	150154
MERCEDES BENZ		0005402917.....	181586	0011593701.....	100537	0025454232.....	160442
000 540 24 17.....	181586	0005403817.....	181586	0011593801.....	100537	0025454332.....	160442
000 540 26 17.....	181586	0005404117.....	181586	0011594201.....	100537	0025455832.....	150154
000 540 27 17.....	181586	0005404517.....	181586	0011595001.....	100652	0025455932.....	150154
000 540 29 17.....	181586	0005404917.....	181586	0011595601.....	100678	0025459032.....	150154
000 540 38 17.....	181586	0005405017.....	181586	0011595801.....	100680	0028301508.....	261306
000 540 41 17.....	181586	0005405117.....	181586	0011596601.....	100680	0031585001.....	150516
000 540 45 17.....	181586	0005405517.....	181586	0011596801.....	100678	0032529605.....	160337
000 540 48 17.....	181589	0005405617.....	181586	0012012000.....	070192	0035445203.....	171299
000 540 49 17.....	181586	0005405917.....	181586	0015310260.....	160337	0035445303.....	171302
000 540 50 17.....	181586	0005408617.....	181586	0015400517.....	181592	0035445403.....	171303
000 540 51 17.....	181586	0005442834.....	170936	0015400717.....	181592	0035445503.....	171299
000 540 52 17.....	181589	0005443234.....	170936	0015401317.....	181586	0035445603.....	171302
000 540 55 17.....	181586	0005454214.....	181197	0015403717.....	181592	0035451632.....	150154
000 540 56 17.....	181586	0005455405.....	160337	0015403817.....	181592	0035451732.....	150154
000 540 59 17.....	181586	0005455805.....	160216	0015404617.....	181592	0035451905.....	160470
000 540 60 17.....	181592	0005458005.....	160168	0015404717.....	181592	0035452005.....	160470
000 540 62 17.....	181590	0005458405.....	160337	0015405017.....	181592	0035454032.....	150154
000 540 65 17.....	181589	0005458425.....	160337	0015405117.....	181592	0035454132.....	150154
000 540 71 17.....	181588	0005458485.....	160394	0015406017.....	181592	0035459805.....	160216
000 540 72 17.....	181588	0005459005.....	160216	0015406270.....	171311	004 542 07 18.....	181591
000 540 73 17.....	181586	0008201710.....	160317	0015406370.....	171308	004 542 08 18.....	181591

ACCESSORIES

O. E. M. names and numbers are used for reference purposes only.

OE No.	HC-CARGO	OE No.	HC-CARGO	OE No.	HC-CARGO	OE No.	HC-CARGO
MERCEDES BENZ continued							
0045420718	181591	25421119	160365	A0005407217	181588	A0025400617	181591
0045420818	181591	25421219	160919	A0005407317	181586	A0025400817	181591
0045451105	160216	25421519	160282	A0005407417	181588	A0025420219	160282
0045452614	180648	25422619	160282	A0005407517	181588	A0025421119	160365
0045456405	160216	2542261928	160282	A0005407617	181588	A0025421218	181584
005 542 24 17	181584	2542261964	160282	A0005408117	181588	A0025421219	160919
005 542 25 17	181584	25427219	160282	A0005408217	181586	A0025421419	160403
005 542 62 17	181584	25427419	160403	A0005408317	181586	A0025421519	160282
005 542 63 17	181584	25428019	160282	A0005408517	181588	A0025422419	160216
005 542 73 17	181584	25428519	160919	A0005408617	181586	A0025422619	160282
005 542 85 17	181584	25428619	160919	A0005408917	181588	A002542261928	160282
0051537828	150797	25428719	160282	A0005409017	181588	A002542261964	160282
005458425	160337	25428819	160282	A0005409117	181588	A0025422719	160366
0055422417	181584	25428919	160403	A0005409517	181590	A0025422819	160366
0055422517	181584	25451319	160282	A0005409617	181588	A0025423019	160366
0055426217	181584	25451419	160403	A0005409717	181588	A0025427219	160282
0055426317	181584	2709060500	150912	A0005442834	170936	A0025427419	160403
0055427317	181584	2769063700	150585	A0005443234	170936	A0025428019	160282
0055428517	181584	2819060000	150666	A000545405	160337	A0025428319	160365
006 542 19 17	181584	33700580052	160263	A0005455505	160403	A0025428419	160365
006 542 21 17	181584	3460170160	080441	A0005455805	160216	A0025428519	160919
006 542 22 17	181584	3460170260	080442	A0005458005	160168	A0025428619	160919
006 542 23 17	181584	35452705	160403	A0005458305	160403	A0025428719	160282
006 542 90 17	181585	35458605	160403	A0005458405	160337	A0025428819	160282
006 542 96 17	181585	3645427319	161035	A0005458425	160337	A0025428919	160403
0065421917	181584	4151590001	100685	A0005459005	160216	A0025450005	160169
0065422117	181584	45450405	160403	A0005459005	160337	A0025451119	160365
0065422117KZ	181584	45452905	160919	A0006409617	181588	A0025451319	160282
0065422217	181584	51537828	150797	A0008201710	160317	A0025451419	160403
0065422317	181584	54555505	160403	A0008210163	160403	A0025452419	160216
0065422317KZ	181584	54555505	160403	A0008219547	160317	A0028301508	261306
0065453724	180959	5458305	160403	A0008261741	171230	A0035420219	160919
007 542 31 17	181585	5458425	160337	A0009908330	192569	A0035425817	180634
007 542 32 17	181585	5459005	160337	A0011591501	100327	A0035452705	160403
007 542 52 17	181585	554 224 17	181584	A0011592601	100337	A0035458605	160403
007 542 68 17	181585	589931022900	160216	A0011595001	100652	A0035459605	160337
007 542 94 17	181585	6010170060	080736	A0011595601	100678	A0035459805	160216
0075426817	181584	6010170360	080732	A0011595701	100680	A0045420718	181591
0075451632	160448	6110170060	081055	A0011595801	100680	A0045420818	181591
0075459832	160445	6110170360	081067	A0011596601	100680	A0045450405	160403
0075459932	160447	6110170460	081068	A0011596801	100678	A0045451105	160216
0085450032	160446	6388600126	160197	A0015310260	160337	A0045452905	160919
009 542 05 17	181585	654 221 17	181584	A0015400117	181588	A0045456405	160216
009 542 06 17	181585	7131662460	160216	A0015400417	181590	A0051537828	150797
009 542 38 17	181584	7375181000	160366	A0015400517	181592	A0054555505	160403
009 542 43 17	181585	8.125.43.508.88	190766	A0015400717	181592	A0055422417	181584
009 542 45 17	181585	8210163	160403	A0015400817	181588	A0055422517	181584
009 542 87 17	181585	9.910.05.820.56	190766	A0015401017	181588	A0055426217	181584
0095423817	181584	99000580236	160266	A0015401117	181588	A0055426317	181584
0095429017	181587	A0000005717	190766	A0015401217	181588	A0055427317	181584
0095429117	181587	A0001501580	150625	A0015401317	181586	A0055428517	181584
0095429217	181587	A0001502980	150625	A0015402817	181588	A0065421917	181584
0095429317	181587	A0001580003	150395	A0015403717	181592	A0065422117	181584
0095429417	181587	A0001582603	150917	A0015403817	181592	A0065422217	181584
0125456428	180399	A0001583703	150917	A0015404617	181592	A0065422317	181584
0255455432	160449	A0001583803	150395	A0015404717	181592	A0065429017	181585
12131286087	150527	A0001584903	150917	A0015405017	181592	A0065429617	181585
133700580026	160263	A0001586103	150915	A0015405117	181592	A0075423117	181585
134876010	170936	A0001586403	150914	A0015406017	181592	A0075423217	181585
135420617	180634	A0001587803	150557	A0015407017	181592	A0075425217	181585
135700580021	160263	A0003043V002000000	150812	A0015407117	181592	A0075426817	181585
1408690221	160679	A0005402417	181586	A0015407317	181592	A0075429417	181585
1501580	150625	A0005402617	181586	A0015407417	181592	A0095420517	181585
1502980	150625	A0005402717	181586	A0015407517	181592	A0095420617	181585
15429219	160403	A0005402917	181586	A0015407617	181592	A0095423817	181584
1580003	150395	A0005403817	181586	A0015407917	181591	A0095424317	181585
1583803	150395	A0005404117	181586	A0015408017	181592	A0095424517	181585
1587003	150424	A0005404517	181586	A0015408517	181592	A0095428717	181585
1587103	150424	A0005404817	181589	A0015408717	181592	A0095429017	181587
1587503	150424	A0005404917	181586	A0015409217	181592	A0095429117	181587
1587803	150557	A0005405017	181586	A0015409517	181591	A0095429217	181587
2.812.54.350.88.81	190766	A0005405217	181589	A0015423219	160265	A0095429317	181587
2018210047	160287	A0005405517	181586	A0015425619	160266	A0095429417	181587
2028209342	261320	A0005405617	181586	A0015429219	160403	A0125456428	180399
2108202442	261346	A0005405917	181586	A0015455405	160394	A0135420517	150789
2108206842	261356	A0005406017	181592	A0018300308	161719	A0135420617	180634
2108240018	160403	A0005406217	181590	A0018305708	261325	A2028209342	261320
2218690121	160379	A0005406517	181589	A0018354106	160081	A2108202442	261346
25420219	160282	A0005407117	181588	A0025400117	181591	A2108206842	261356

OE No.	HC-CARGO	OE No.	HC-CARGO	OE No.	HC-CARGO	OE No.	HC-CARGO
A2108240018	160403	J2T00972	150901	MD131447	181584	MD319788	181592
A2709060500	150912	J862	150512	MD131540	181584	MD325048	150890
A6079051400	150763	J9T03372	150377	MD132243	150377	MD327610	181590
A7131662460	160216	MO 4606037	181590	MD136308	181590	MD327611	181590
A7375181000	160366	MO 4671052	181591	MD136309	181584	MD329341	181591
		MO 5269711	181590	MD136310	181590	MD330259	181591
MITSUBISHI		MO4671066	181590	MD136491	181590	MD331050	181590
1588A002	181591	M816732	100512	MD136493	181590	MD331887	181591
1588A005	181591	M851148	150804	MD138993	150768	MD332735	181591
1588A020	181590	M882369	150775	MD138993	150777	MD333990	181591
1588A021	181591	M883828	100684	MD138993	150783	MD333993	181591
1588A043	181591	M901X01571	191531	MD138993	150798	MD333994	181591
1588A050	181591	M981D73202	191873	MD138993	180641	MD333995	181590
1588A051	181591	M981D73205	191585	MD138994	150783	MD333996	181590
1588A069	181591	M981S70101	191584	MD140388	181584	MD334299	181590
1588A070	181591	M981S70106	192063	MD142206	181591	MD335028	181590
1588A107	181591	MC840219	150764	MD142209	181591	MD335040	181591
1588A117	181591	MC840219	150768	MD143490	181591	MD335051	181591
1588A206	181590	MC840219	150783	MD147878	181584	MD335431	181590
1588A207	181590	MC840219	150798	MD149813	181584	MD335916	181591
1588A209	181591	MC840219	180641	MD150609	181584	MD336448	181590
1588A210	181591	MD001482	150764	MD153923	181584	MD336490	181590
17612	150395	MD001482	150768	MD164422	181591	MD337891	181590
1832A016	150646	MD001482	150777	MD164423	181591	MD338845	181591
1860B661	161738	MD001482	150783	MD164475	150377	MD338846	181590
210843	210843	MD001482	150798	MD165081	181591	MD339640	181591
210948	210948	MD001482	180641	MD165083	181591	MD339641	181591
3921021320	181584	MD001483	150798	MD17613	150395	MD342323	181590
3921021340	181584	MD001483	180641	MD177968	181591	MD342688	181591
3921024520	181584	MD001800	150395	MD177969	181591	MD342689	181591
3921024550	181584	MD001804	150395	MD180388	181584	MD342693	181590
56028998AB	181591	MD003801	150395	MD180618	181591	MD342694	181590
56029049AA	181590	MD003804	150395	MD181398	181591	MD342775	181590
56029050AA	181590	MD003806	150395	MD182691	181590	MD343421	181591
9311600	150572	MD003821	150533	MD182792	181590	MD343986	181591
9475021010	180641	MD005480	150768	MD182793	181590	MD343987	181591
9475021020	180641	MD008820	150395	MD183145	181590	MD343988	181591
9475021030	180641	MD008821	150395	MD183399	181590	MD343989	181591
94750-21030	150768	MD011225	181584	MD184939	181591	MD344002	181591
94750-21030	150798	MD017430	150798	MD185334	181591	MD344469	100670
A00715X05271	190470	MD017430	180641	MD185335	181591	MD345230	181591
A00715X05371	191789	MD017612	150395	MD186392	181591	MD345770	181591
A414X01471	192065	MD021566	150768	MD186990	181591	MD345771	181591
A414X06771	192065	MD021566	150777	MD186991	181590	MD345772	181590
A414X12771	191267	MD021566	150783	MD186992	181591	MD345773	181591
A414X12871	191267	MD021566	150798	MD188208	181590	MD348512	181591
A414X18271	191267	MD021566	180641	MD188408	181590	MD354500	100670
A414X22871	191267	MD021567	180641	MD189007	181591	MD354850	181590
A414X24271	191586	MD050212	100246	MD189008	181591	MD354851	181590
A414X24671	191586	MD068355	080457	MD192071	181591	MD355645	150783
A715X01871	190470	MD070717	080705	MD192072	181591	MD357265	181591
A715X01971	191789	MD070718	080417	MD192091	181591	MD357266	181591
A715X05271	190470	MD073175	181584	MD194705	181591	MD357284	181590
A715X05371	191789	MD073461	181584	MD197511	100510	MD357285	181590
AW327504	181584	MD073546	181584	MD198529	181590	MD357286	181591
CYGS065A	150157	MD076706	181584	MD198535	181590	MD359910	181591
DYE923	150068	MD077621	181584	MD300080	181590	MD360181	181591
EJN902	150096	MD078791	181584	MD301950	100670	MD360182	181590
J007T00371	150068	MD080624	150917	MD302068	181591	MD360384	150890
J007T01571	150234	MD088116	181584	MD305144	181590	MD361710	150658
J007X00671	150160	MD088616	181584	MD305145	181591	MD362903	150658
J007X00812	150417	MD089922	181584	MD305146	181591	MD362903	150890
J007X00871	150160	MD107793	181584	MD305147	181591	MD362907	150890
J007X00971	150377	MD108934	181584	MD305148	181591	MD362913	150908
J007X01172	150234	MD109613	181584	MD305149	181591	MD365014	181590
J007X01175	150234	MD110487	181584	MD306893	181591	MD365016	181591
J007X01271	150377	MD110492	181584	MD306894	181591	MD366821	150908
J009T02071	150377	MD117240	181584	MD307258	181590	MD366935	181591
J106	150068	MD117242	181584	MD311230	181590	MD366936	181591
J117	150160	MD117280	181584	MD312083	181591	MD369190	181590
J120	150234	MD119210	181584	MD312084	181591	MD369192	181591
J121	150377	MD119609	181584	MD313819	181591	MD560366	181591
J152	150096	MD121306	181584	MD314060	181591	MD607364	150068
J153	150378	MD126181	181584	MD314061	181591	MD607409	150417
J170	150234	MD127062	181584	MD314062	181591	MD607478(2)	150068
J170A	150234	MD128262	181584	MD314687	181590	MD607814(2)	150096
J207	150417	MD129183	181584	MD315175	181591	MD611384(2)	150096
J2T00572	150901	MD129550	150377	MD319786	181590	MD611384(2)	150377
J2T00772	150901	MD131446	181584	MD319787	181591	MD618268	150377

ACCESSORIES

O. E. M. names and numbers are used for reference purposes only.

OE No.	HC-CARGO	OE No.	HC-CARGO	OE No.	HC-CARGO	OE No.	HC-CARGO
MITSUBISHI continued							
MD618293	150378	MW30899625	181191	CN16	150661	EFG315	AS301
ME200970	100559	MW31216548	150775	CN19	150648	EFG5	AS301
ME201632	100559			CN35	150582	EFG5	AS301
ME201638	100563	MOBILETRON		CN38	150623	SW978	180636
ME203583	100559	CC20	150252	CN46	150611	MOTOROLA	
ME203754	100559	CE06	150612	CSE001	150468	AM2	150058
MK666920	161735	CE-08	150246	CSE008	150354	CM17	150629
MK668289	161735	CE113	150620	CSE097	150470	GM1	150058
MM409510	100521	CE114	150616	CT08	150266	MWM	
MN119979	181591	CE127	150671	CT24	150663	008379050055	090020
MN122267	181591	CE143	150656	CT25	150614	2613603	080696
MN135962	181591	CE147	150624	CT26	150658	304920000002	080692
MN135963	181591	CE149	150513	CT29	150654	305209900020	090020
MN137360	150808	CE151	150657	CT36	150655	305209900039	090020
MN153010	181590	CE153	150606	CT37	150617	604920100610	080696
MN158670	181590	CE156	150640	CT38	150662	605202000021	090016
MN158671	181590	CE161	150651	CT40	150645	605202030028	090015
MN158757	181590	CE163	150652	CT47	150647	605202030031	090202
MN158758	181590	CE168	150649	CU05	150631	606901200143	080696
MN158759	181591	CE171	150574	IG-B002H	150055	905202000021	090016
MN158773	181591	CE182	150608	IG-B018K	150435	906901200136	080390
MN158916	181591	CE183	150618	IG-D1906	150058	NAGARES	
MN158917	181591	CE186	150625	IG-D1908H	150072	AVE212	160276
MN158918	181590	CE190	150608	IG-D1910H	150057	BDL712	161120
MN158919	181590	CE-24	150259	IG-D1912	150175	BED712	160795
MN158920	181591	CE25	150521	IG-D1951	150064	BOL712	161736
MN158921	181591	CE26	150634	IG-D1951H	150064	BRE512	160718
MN158997	181592	CE27	150522	IG-D1959H	150062	BRE612	160719
MN163400	181590	CE-28	150505	IG-D1961HV	150063	IT4412	160243
MN163401	181590	CE-30	150434	IG-D1978	150239	ITA412	160312
MN163465	181590	CE37	150252	IG-D1979	150239	ITA512	160314
MN163466	181590	CE-38	150433	IG-D1980HV	150239	ITE3	160312
MN163467	181590	CE-39	150668	IG-F138H	150067	ITE324	160313
MN163468	181591	CE-42	150441	IG-FT001H	150088	ITG312	160242
MN163469	181591	CE-45	150508	IG-FT004	150165	ITG324	160261
MN163470	181591	CE-51	150509	IG-H004H	150056	ITG412	160244
MN163491	181590	CE52	150635	IG-H005H	150075	ITGS312	160242
MN163492	181591	CE55	150525	IG-H010	150154	ITGS324	160261
MN163743	150782	CE-56	150428	IG-H016K	150227	ITGS412	160243
MN183468	181590	CE57	150424	IG-HD003	150236	ITH3	160341
MN183469	181590	CE64	150641	IG-M001	150068	ITJS312	160315
MN195452	150886	CE67	150520	IG-M004H	150096	ITRC6	160262
MN195616	150886	CE72	150609	IG-M004HV	150096	MR1220	160363
MN195805	150629	CE78	150653	IG-M005	150160	MRIS1220	160919
MN980234	100625	CE79	150633	IG-M007	150234	MRS1220	160365
MN985103	181591	CE81	150650	IG-M009	150377	PPC512	160434
MR135963	181591	CE86	150557	IG-M010	150378	PPC712	160436
MR420631	181590	CE93	150636	IG-N5016	150398	RBC2112	161121
MR420979	181591	CF-46	150416	IG-SK001	150215	RDP512	160168
MR507028	181591	CF60	150637	MAB038	181500	RDP524	160169
MR507031	181591	CF62	150558	MAG006	181494	RL18012	160477
MR507385	181590	CF69	150416	TX-AD001	211156	RL8024	160478
MR507386	181590	CF73	150610	TX-P001	211158	RLAC412	160239
MR507387	181591	CG-16	150403	TX-P002	211159	RLAC424	160240
MR507809	181591	CG21	150619	TX-P003	211160	RLP412	160311
MR507846	181590	CG25	150621	TX-P004	211161	RLP512	160265
MR507854	181591	CG29	150643	TX-PT001	211155	RLP5212D	160270
MR514342	181591	CH03	150270	TX-PT001A	211157	RLP5212R	160403
MR560318	181591	CH23	150673	MOTORCRAFT			
MR560331	181590	CH24	150644	DG464	150901	RLP5224	160216
MR560364	181590	CH25	150630	DGE437	150901	RLP5224D	160271
MR560365	181591	CH26	150628	DGE439	150901	RLP524	160266
MR560366	181591	CH27	150639	DGE450	150901	RLPA412	160083
MR561593	181590	CH29	150615	DYE472	150056	RLPA424	160215
MR577131	100670	CH33	150622	DYE524	150160	RLPA5212	160316
MR578081	181590	CJ04	150605	DYE539	150160	RLPA5224	160317
MR578113	181591	CJ22	150614	DYE589	150160	RLPD12	160267
MR578114	181591	CK04	150638	DYG216	150058	RLPS12	160282
MR578532	181591	CK19	150660	DYG469	150062	RLPS412	160282
MR578634	181590	CK22	150659	DYG471	150063	RLPS424	160307
MR985102	181590	CK24	150642	EDG1	150917	RLPS5212	160308
MR985103	181591	CK32	150632	EDG37	150546	RLPS5224	160337
MR985164	181590	CK33	150627	EDY4	150067	RP10024	160721
MR985165	181591	CK35	150672	EDY4(2)	150067	RP12012	160720
MR988902	181590	CK41R	150607	EDY8	150057	RTP612	160461
MR988903	181590	CK42	150626	EFG3	AS301	RZE212	160347
MR988905	181590	CM13	150646	EFG3	AS301		
MR988905	181590	CM17	150629	EFG315	AS301		
MW119210	181584	CN14	150613				

OE No.	HC-CARGO	OE No.	HC-CARGO	OE No.	HC-CARGO	OE No.	HC-CARGO
TDP1212	160423	U1001	150227	Y-106	100434	NIKKO	
TPD1010	160426	U1004	150270	Y-106-1	100435	0-0274-06652	191645
TPD512	160424	U1008	150612	Y-106V	100434	0-0276-06352	192063
TPD612	160425	U1014	150266	Y-107R	100261	0-23303-0010	190499
TPDSG612	160451	U1020	150885	Y-107T	100286		
TPDV8212	161735	U1024	150901	Y-107V	100634	NISSAN	
TPF612	160416	U1026	150891	Y-112M-1	100251	01436-00QAB	150404
TPPF612	160469	U1031	150621	Y-112R-1	100254	01501081-0	160282
TPPSS712	160421	U1037	150896	Y-112T	100247	01501189-0	160327
TPPSS712	160422	U2001	150416	Y-114T	100521	01505634-0	160311
TRM1212	160438	U2003	150435	Y-115T-1	100246	01505997-0	160282
TRMK1212	160438	U2004	150403	Y-118R	100258	01506377-0	160311
		U2006	150252	Y-118T	100260	01506437-0	160282
NEC		U2007	150433	Y-118T-1	100260	01506584-0	160308
MC8132	150236	U2008	150558	Y-128T	100256	1106500Q0E	100685
MC8183	150236	U2009	150259	Y-145T	100636	11065-00Q0E	100685
MC8541	150236	U2010	150887	Y-146R	100257	11065-00Q0G	100676
		U2011	150641	Y-162R-1	100252	11065-00QAF	100684
NEW HOLLAND		U2016	150668	Y-178T	100280	11065-00QAG	100684
8017114	090318	U2018	150619	Y-197T	100282	11065-0W801	100336
82004463	160265	U2019	150899	Y-204TS	100512	11065-10G00	100271
82006984	070134	U2021	150884	Y-204V	100512	11065-16A011	100271
82012872	160311	U2028	150624	Y-205RS	100271	11065-2W202	100578
82023238	160919	U2035	150907	Y-206T	100511	11065-2W211	100578
87329426	160403	U2039	150638	Y-207	100512	11065-31N00	100306
		U2040	150895	Y-207TS	100512	11065-31W00	100247
		U2060	150900	Y-208T	100511	11065-31W01	100247
NGK		U2061	150660	Y-2712	100658	11065-31W02	100247
1239	100512	U2062	150910	Y-403T	100086	11065-34W00	100251
1249	100271	U3001	150246	Y-404	100566	11065-43G01	100287
1250	100511	U3003	150434	Y-503R	100436	11065-57J00	100326
2190	100282	U3004	150557	Y-504J	100533	11065-5C900	100326
2408	100436	U3018	150894	Y-508J	100651	11065-5X00A	100676
2431	100252	U4006	150642	Y-517J	100646	11065-65N01	100336
2785	100331	U4009	150671	Y-527J	100661	11065-7C000	100666
3413	100645	U4012	150908	Y-547AS	100641	11065-AD200	100653
3782	100283	U4014	150890	Y-55RS	100276	11065-AD201	100653
4389	100650	U4026	150424	Y-607AS	100624	11065-AD20A	100653
4479	100303	U5002	150509	Y-609AS	100673	11065-AD21A	100653
4602	100284	U5003	150441	Y-701J	100520	11065-AP200	100560
4751	100303	U5004	150428	Y-702U	100522	11065-BN701	100684
48004	150650	U5006	150513	Y-703R	100511	11065-C8600	100276
48007	150441	U5010	150903	Y-705RS	100271	11065-D9701	100302
48015	150513	U5014	150657	Y-707RS	100287	11065-D9702	100302
48027	150558	U5015	150656	Y-709R	100644	11065-G2400	100306
48032	150653	U5018	150609	Y-710R	100292	11065-G5501	100302
48033	150608	U5027	150663	Y-711RS	100426	11065-T8200	100254
48044	150416	U5032	150648	Y-715R	100291	11065-T8201	100252
48114	150620	U5036	150613	Y-716RS	100524	11065-T8202	100254
48131	150625	U5043	150582	Y-721RS	100668	11065-T8203	100252
48135	150640	U5061	150661	Y-729	100307	11065-V7202	100325
48141	150621	U5065	150655	Y733J	100557	11065-V7203	100324
48153	150888	U5067	150632	Y-733J	100670	11067-JD50A	161120
48216	150574	U5072	150627	Y-741U	100527	11067-JD50C	161740
48231	150904	U5076	150645	Y-755RS	100276	1516090001	150786
48256	150659	U5077	150893	Y-8002AS	100652	16625-05E00	080734
48292	150639	U5081	150615	Y-8003J	100627	16625-43G00	080424
48347	150623	U5083	150898	Y-810	100262	16625-V0701	080688
48404	150649	U5090	150662	Y-901R	100511	16625-V0702	080688
5116	100515	U5097	150639	Y-902R	100511	16626-09W00	080388
5274	100335	U5098	150628	Y-904M	100657	16626-0M900	080736
5376	100260	U5099	150630	Y-904M1	100657	16626-16A00	080736
7-207	100512	U5100	150654	Y-907R	100303	16626-43G00	080689
7464	100515	U5119	150623	Y-908R	100511	16635-16A00	080389
7825	100280	U6001	150650	Y-909R	100284	16635-J2000	080456
CX-01	100325	U6002	150521	Y-910J	100303	22020-G5111	150160
CY-01	100302	U6003	150525	Y-910R	100303	2243309E10	150917
CY-02	100326	U6004	150520	Y-911R	100303	224330B000	150901
CY-03	100513	U6005	150522	Y-924J	100541	224330B001	150901
CY-05	100563	U6008	150634	Y-929U	100337	224330B010	150901
CY-07	100510	U6009	150653	YE01	100518	2243310W00	150917
CY-08	100336	U6019	150633	YE04	100593	22433-14800	150395
CZ-01	100324	U6020	150620	Y-E05	100663	22433-14805	150395
CZ-104	100681	U6025	150640	Y-E08	100664	22433-14806	150395
CZ-106	100678	U6033	150616			22433-14810	150395
CZ-22	100555	U6036	150441	NIHON		22433-14811	150395
CZ-301	100641	Y-103V	100433	192145	192145	22433-14815	150395
CZ-303	100680	Y-104	100275			22433-14816	150395
CZ-304	100682	Y-104R	100245			22433-14900	150395

ACCESSORIES

O.E.M. names and numbers are used for reference purposes only.

OE No.	HC-CARGO	OE No.	HC-CARGO	OE No.	HC-CARGO	OE No.	HC-CARGO
NISSAN continued							
22433-14905	150395	22690-2S701	181585	22690-V4060	181584	226A0-4S102	181589
22433-31300	150395	22690-2U801	181585	22690-V5201	181585	226A0-4S103	181589
22433-31303	150395	22690-2Y010	181585	22690-V5202	181585	226A0-4S110	181589
2243343110	150917	22690-2Y020	181585	22690-V9410	181584	226A0-4S112	181589
2243351J10	150901	22690-2Y021	181585	22690-VG301	181585	226A0-4S113	181589
22433-51J10	150901	22690-2Y500	181585	22690-VG303	181585	226A0-4W001	181589
22433-53A10	150539	22690-2Y510	181585	22690-WD800	181585	226A0-4W005	181589
2243353J20	150901	22690-2Y520	181585	22690-WD801	181585	226A0-4W010	181589
2243355S10	150901	22690-2Y521	181585	22691-0W000	181585	226A0-5E410	181589
2243356E11	150901	22690-30R00	181584	22691-2Y020	181585	226A0-5E411	181589
2243356E12	150901	22690-30R15	181584	22691-2Y021	181585	226A0-5E412	181589
22433-58000	150395	22690-31U00	181585	22691-4L001	181585	226A0-5E413	181589
22433-78500	150395	22690-31U01	181585	22691-4L003	181585	226A0-5E460	181589
22433-78510	150395	22690-3C202	181585	22691-5W900	181590	226A0-5E461	181589
22433-79011	150395	22690-4A0A3	181591	22691-6N205	181585	226A0-5M010	181589
22433-79012	150395	22690-4E810	181584	22691-6N206	181585	226A0-5M011	181589
22433-L1610	150395	22690-4E811	181584	22691-8U000	181590	226A0-5M012	181589
22433-L6800	150395	22690-4J901	181589	22691-AH121	181585	226A0-5W900	181591
22433-L6801	150395	22690-4J903	181589	22691-AR210	181590	226A0-5Y700	181589
22433U3100	150917	22690-4L000	181585	22691-VG301	181585	226A0-5Y701	181589
22433U3110	150917	22690-4L002	181585	22691-VG303	181585	226A0-67U01	181589
22433U3140	150917	22690-4M500	181585	226A0-0L710	181589	226A0-67U03	181589
22433-U3140	150532	22690-4M805	181585	226A0-0L711	181589	226A0-6B701	181589
22433UJ110	150395	22690-4M815	181585	226A0-0L712	181589	226A0-6B702	181589
2244800Q0B	150505	22690-4M820	181585	226A0-0L713	181589	226A0-6B703	181589
2244800QAC	150505	22690-4W010	181585	226A0-0W000	181589	226A0-6M402	181589
2244800QAD	150441	22690-4W012	181585	226A0-0W001	181589	226A0-6M406	181589
22448-00QAE	150505	22690-50Y00	181584	226A0-0W002	181589	226A0-6N161	181590
22448-00QOB	150505	22690-55Y00	181584	226A0-0W010	181589	226A0-6P101	181589
22448-00QAA	150505	22690-56E00	181585	226A0-0W011	181585	226A0-6P103	181589
224480C801	150901	22690-5E410	181589	226A0-0W012	181589	226A0-6P104	181589
224480C802	150901	22690-5E411	181589	226A0-1B010	181590	226A0-6P107	181589
22448-1F700	150562	22690-5M500	181585	226A0-1B011	181590	226A0-6P108	181589
22448-1KT0A	150611	22690-5M501	181585	226A0-1B012	181590	226A0-7B013	181589
22448-4M500	150648	22690-5W900	181590	226A0-1B013	181590	226A0-7B014	181589
22448-4M50A	150648	22690-6A0A0	181591	226A0-1S700	181590	226A0-7B503	181589
22448-6N000	150613	22690-6A0A1	181591	226A0-1S705	181590	226A0-7B504	181589
22448-6N002	150613	22690-6A0A2	181591	226A0-1S710	181590	226A0-7J100	181589
22448-6N010	150613	22690-6N205	181585	226A0-1S715	181590	226A0-7J101	181589
224486N011	150505	22690-6N206	181585	226A0-2Y901	181589	226A0-7J400	181589
22448-6N012	150613	22690-6P107	181589	226A0-2Y902	181589	226A0-7J401	181589
22448-6N015	150613	22690-75P00	181585	226A0-2Y904	181589	226A0-7J402	181589
22448-8H315	150661	22690-75P10	181585	226A0-3S501	181589	226A0-7S001	181591
22448D4000	150901	22690-7B520	181589	226A0-3S502	181589	226A0-81F01	181589
22448-ED000	150623	22690-81F02	181589	226A0-3S503	181589	226A0-81F02	181589
22448-ED800	150582	22690-81F12	181589	226A0-3S506	181589	226A0-81F04	181589
22448EN000	150623	22690-8J001	181591	226A0-3S507	181589	226A0-81F11	181589
22448EN200	150623	22690-8J010	181591	226A0-3S508	181589	226A0-81F12	181589
22448EY00A	150623	22690-8U000	181590	226A0-3S511	181589	226A0-8J010	181591
22448JA00A	150623	22690-8U300	181591	226A0-3S512	181589	226A0-8U300	181591
22448-JA00C	150623	22690-95E00	181584	226A0-3S513	181589	226A0-9E800	181589
2246253A10	150917	22690-9S200	181585	226A0-3S560	181589	226A0-9E801	181589
22630-00Q1D	150791	22690-AE201	181585	226A0-3S561	181589	226A0-AM601	181591
2263000QAE	150791	22690-AG920	181585	226A0-3S570	181589	226A0-AR210	181591
22690-01P00	181585	22690-AG921	181585	226A0-3S571	181589	226A0-AU011	181591
22690-01Y00	181584	22690-AH120	181585	226A0-3S575	181589	226A0-EA200	181591
22690-07G01	181584	22690-AH121	181585	226A0-3S601	181589	226A0-EA210	181591
22690-09P00	181585	22690-AL600	181590	226A0-3S602	181589	226A1-0W002	181589
22690-09P01	181585	22690-AN210	181585	226A0-3S603	181589	226A1-18Y01	181589
22690-0E000	181585	22690-AN215	181585	226A0-3S606	181589	226A1-18Y02	181589
22690-0M200	181585	22690-AQ800	181591	226A0-3S607	181589	226A1-18Y03	181589
22690-0S200	181584	22690-AR202	181585	226A0-3S608	181589	226A1-18Y05	181589
22690-0U000	181584	22690-AW003	181585	226A0-3S660	181589	226A1-4L711	181589
22690-0W001	181585	22690-D4200	181585	226A0-3S661	181589	226A1-4L712	181589
22690-12P00	181585	22690-F2500	181584	226A0-3S665	181589	226A1-4L715	181589
22690-12P01	181585	22690-F2510	181584	226A0-3S666	181589	226A1-4S100	181589
22690-17B00	181584	22690-F2520	181584	226A0-4J901	181589	226A1-4S101	181589
22690-19B10	181584	22690-F5100	181584	226A0-4J903	181589	226A1-4S102	181589
22690-1B000	181590	22690-F5300	181584	226A0-4L710	181589	226A1-4S103	181589
22690-1B010	181590	22690-F5360	181584	226A0-4L711	181589	226A1-4W001	181589
22690-1E400	181584	22690-HA005	181591	226A0-4L713	181589	226A1-4W004	181589
22690-1F701	181590	22690-J8000	181584	226A0-4M210	181589	226A1-4W010	181589
22690-20R00	181584	22690-J9200	181584	226A0-4M221	181589	226A1-4W011	181589
22690-28F60	181585	22690-P5100	181584	226A0-4S000	181589	226A1-5M011	181589
22690-2A000	181590	22690-P6500	181584	226A0-4S001	181589	226A1-5M012	181589
22690-2B000	181584	22690-P6510	181584	226A0-4S010	181589	226A1-5W900	181591
22690-2J200	181585	22690-P6590	181584	226A0-4S011	181589	226A1-5Y700	181589
22690-2J201	181585	22690-V2000	181584	226A0-4S100	181589	226A1-5Y701	181589
22690-2S700	181585	22690-V4000	181584	226A0-4S101	181589	226A1-67U02	181589

OE No.	HC-CARGO	OE No.	HC-CARGO	OE No.	HC-CARGO	OE No.	HC-CARGO
226A1-8J100	181589	10457075	150403	1252555	150766	4410676	150791
226A1-8U700	181590	10457870	150884	1252557	150762	4413233	150505
226A1-AM601	181591	1207248	150055	1252561	150770	4415207	150780
226A1-AR210	181591	1208008	150525	1252561	150786	4416764	161120
23300-72J00	192569	1208010	150884	1252562	150762	4418262	150775
23750-00QAH	150404	1208018	150395	1252565	150770	4419200	161740
25012-4A00A	181591	1208020	150633	1252565	150786	4431212	150763
25070-00Q0A	150790	1208021	150650	1252567	150768	4432202	150505
2507080W00	150786	1208033	150056	1252567	150794	4433805	150763
2507089903	150786	1208037	150056	1252569	150761	4433880	150791
2507089972	150774	1208038	150098	1252570	150762	4433882	150807
25070D4200	150774	1208051	150619	1252572	150762	4506156	160795
25070P8000	150786	1208052	150098	1252573	150766	4708758	150759
25070P9700	150786	1208056	150098	1252577	150787	4709290	150911
25230-80A0A	161740	1208063	150403	1252578	150762	4772216	180808
25230-89978	160480	1208071	150668	12565428	181591	4803551	150762
2524000Q0A	150763	1208074	150379	12567680	181591	4805511	100660
2524000Q0B	150791	1208086	150652	12569391	181591	4817876	150762
2524000Q0C	150775	1208092	150649	13100504	160919	4848219	150759
25240-00Q0F	150778	1208096	150649	13101741	160904	5246350	160282
25240-00Q0G	150792	1208098	150651	13171831	160282	55210051	100690
25240-00Q0H	150807	1208241	150056	13266315	160919	55354141	161736
2524000QAB	150791	1208243	150098	1337464	150175	555584404	150651
2524000QAD	150807	1208246	150056	1338444	180875	55561655	150652
2524000QAE	150792	1208248	150055	1338448	180808	55573735	150649
25240-00QAG	150780	1208307	150521	1338451	180875	55575499	150649
2524000QAH	150763	1211560	150062	1338458	180875	55577898	150649
2524000QAA	150775	1211561	150064	1338467	181395	55579072	150649
25240-4M400	150774	1211582	150063	1338506	180636	55588475	100555
25240-4M400	150780	1211591	150063	1338511	181395	55702442	261338
252404M40E	150780	1214028	100662	1341010	181034	592790	150055
252406F900	150774	1214032	100627	1341030	181088	594502	150055
2524070J00	150774	1214035	100555	13411010	181034	594503	150055
2524089900	150770	1214036	100662	1342561	180808	594531(2)	150055
2524089901	150770	1214065	100555	1342567	180808	594533(2)	150055
2524089901	150786	1214300	100583	1342568	180808	594539(2)	150055
2524089902	150770	1214301	100555	13500118	160282	594548	150055
2524089902	150786	1214303	100086	13500119	160403	594560(2)	150055
2524089910	150770	1214304	100511	13500120	160282	5954839	100662
2524089910	150786	1214305	100511	1450156	160197	6235037	150640
25240-89911	180641	1214306	100511	1450174	160197	6235303	161736
25240-89915	150774	1214307	100511	1450182	160197	6237752	150062
25240-89920	150774	1214310	100426	1450185	150809	6237753	150063
25240-89960	150774	1214311	100292	1780229	080696	6237754	150064
25240AW300	150791	1214312	100292	1808068	261328	6237777	150175
25240BN700	150807	1214317	100511	1845038	261328	6238050	150468
25240-CK80B	150790	1214319	100511	1845055	261340	6238109	150468
25240D9700	150770	1214427	100527	1845057	261328	6238179	181395
25240-G2400	150774	1214457	100544	1845066	261342	6238317	180875
25240Y9501	150770	1224124	170936	1845080	261343	6238422	181395
25240Y9700	150770	1235278	160363	1845089	160879	6240251	150759
26350-G9801	160276	1237334	150380	1845089	261330	6240262	150806
27226-AX100	261351	1237464	150380	1845110	160879	6240415	150759
28810-G9708	160395	1237504	150063	1845110	261330	8 55 305	181584
28810-G9709	160396	1237539	150387	1845121	261330	8 55 315	181584
36531-PNB014	181591	1237976	161736	1845222	261319	8 55 333	181584
77010-57555	261336	1238452	150770	22127653	160197	8 55 389	181590
782000480	150768	1238532	160416	24402859	181592	813561	AS301
782000480	150798	1238537	160416	24403860	181592	815004	070053
90080-19021	150663	1238539	160295	24420584	150633	815005	070053
98831-6F720	181584	1238540	160295	24436989	261319	815011	070053
B2690-12P01	181585	1238542	160352	24438887	160282	819833	080696
B2690-30R00	181584	1238549	160295	25061061	150809	821093	081129
B26A0-67U01	181589	1238550	160297	25133391	181584	821204	080444
		1238563	160352	25163613	181584	821701	080388
		1238565	160416	25164596	181584	82511978	100275
		1238566	160352	25195107	150649	836584	181494
		1238587	160083	32017066	100665	88900717	100538
		1238611	160083	32017084	100665	88900729	100650
		1238621	160311	32017514	100624	8954566	150809
		1238627	160416	3436400	160216	90002862	150395
		1238696	150767	3436400	160337	90006499	150098
		1238966	160295	4400194	150807	90017882	170936
		1239260	181150	4401810	180905	90019495	100086
		1239266	181182	4402231	150775	90020443	070053
		1239271	181182	4402309	181064	90033357	100086
		1247680	150767	4402560	150404	90040991	100303
		1252506	150809	4408389	150505	90040992	160416
		1252552	150761	4409990	160795	90051950	100511

CROSS REFERENCE LIST

ACCESSORIES

O. E. M. names and numbers are used for reference purposes only.

OE No.	HC-CARGO	OE No.	HC-CARGO	OE No.	HC-CARGO	OE No.	HC-CARGO
OPEL continued							
90062964	150098	94221719	100245	5008	170339	6461	170411
90093867	100511	94241449	100245	5008	170772	6461	171095
90093897	100511	94255588	100245	5008L	171992	6475	170588
90140327	080696	94312940	150786	5407	170593	6476	171139
90166155	100511	94319700	100292	5626	171102	6480	170589
9018201	100544	94481972	100426	5627	170413	66042	171613
90187341(2)	150056	94847544	150786	5627	170794	66050	171132
90188755	150098	9522061	160282	5631	171990	66140	171613
90210824	100511	95508486	100627	5637	170351	66144	171613
90226846	160282	95508489	100645	5637	170793	66154	171683
90228928	160416	95517924	150650	62203	170009	66240	171133
90240651	160416	96440144	100660	64070	170493	66350	171710
90243618	150175	97080554	100336	64070	171068	66440	171713
90292723	070053	97210818	100555	6411	170344	66450	171711
90341822	160416	97358626	100555	6411	171098	7135	170816
90348296	150548	97375663	150787	64111	170470	7225	170644
90349944	070053	97532831(2)	150055	64115	170380	7225	171093
90360315	150175	V27605030	170936	64122MF	170751	7234	171977
90398690	190766			64124MF	170752	7240	171994
90414477	160919			6413	170343	7240	172033
90424480	150640	OSRAM		6413	171097	7301	170579
90444189	150387	0881	171010	64132	170741	7309	170575
90444650	150379	2321MFX	171379	64132	171082	7326	171985
90448286	070203	2322MFX	171380	64136	170742	7327	171975
90449574	150379	2351MF6	171381	64136	171083	7351	171974
90458250	150668	2351MFX6	170727	64136	171084	7360	171976
90462248	150387	2351MFX6	171109	64138	171084	7429	171088
90464952	160416	2352MFX6	170756	64149	170696	7430	170583
90487858	100511	2352MFX6	171110	64150	170069	7501	171984
90491314	160403	2452MFX6	171023	64150	170332	7506	170335
90502704	081129	2473MFX6	171033	64150NBU	171686	7506	170769
90506102	150553	2721	170410	64150SUP	170965	7506L	171979
90509271	070203	2721	170775	64150SUP	171070	7507	171089
90510924	100511	2721MF	170357	64151	170070	7507	170648
90511443	160919	2721MF8	170612	64151	170333	7507LDA	171371
90529673	181495	2721MF8W	170545	64151NBP	171687	7511	170349
90532619	150468	2721MFHZ	171382	64152	170493	7511	170826
90542650	080388	2721MEJF	171384	64153	170496	7517	171476
90543014	160403	2721MFX	171024	64155	170449	7526	171983
90543282	181495	2722MF	170610	64155	171072	7527	171988
90568692	261340	2722MF8	170611	64156	170412	7528	170336
91104945	100532	2741	170477	64156	170836	7528	170770
91112377	150764	2741	171108	64173	171073	7528L	170659
91112377	150768	2741MF	170358	64176	171691	7535	171996
91112377	150783	2741MF8	170613	6418	170341	7537	170452
91112377	150798	2741MFX	171028	6418	171094	7537	171092
91127124	150395	2820	170725	64183	170681	7569	171991
91159996	150505	2820	171121	64185	170718	7597	171986
9117693	081115	2821	170331	64193	170334	7669	171978
9118368	150468	2821	171104	64193	170768	7869	171991
9118918	261342	2825	170347	64193	170804	7950	171477
9150494480(2)	150055	2825	171105	64193GP	171114	7951	170338
9150633880(2)	150055	2825L	170662	64193L	170657	7951	170771
9158718	181590	2827	170754	64193L	171113	7952	170350
9193149	181494	2840	171027	64193NBU	171688	9004	170692
9196669	100594	2841	170476	64193SUP	170804	9005	170693
9198834	150640	2841	171106	64193SUP	171066	9006	170694
9202575	181590	2845	170542	64196	170348	9006XS	171794
9202577	181590	2845	171107	64196	170792	9145	171036
9227760	181494	3757	170711	64199	170006	921NA	172230
9287211	160311	3796	170345	64210	170720	94196	170450
93161188	150505	3796	171103	64210NBU	171689	94196	171125
93161575	100676	3797	170416	64211	171037	9507	170849
93161948	150505	3797	170796	64211NBU	171690	9507	171090
93171875	100536	3892	171492	64212	171034	9511	170451
93172269	160919	3893	170346	64213	171035	9511	171078
93177212	150633	3893	170774	64215	170800	9627	170455
93177490	150805	3894	170594	64215	171080	9627	171118
93178047	100627	3895	171491	64215L	171532	9637	170454
93178225	100594	3896	171490	64216	172073	9637	171076
93179850	150468	3898	170448	6423	170414		
93180295	100645	3898	171119	6423	171096		
93183739	100336	3899	170456	6424	171099		
93190433	100688	3930	170417	6428	170590	PERKINS	
93197244	100594	3930	170795	6429	171100	185366190	100619
93198468	100676	5001	171993	6438	170005	2848A270	090225
94021127	150764	5006	171981	6439	170591	2848A275	090225
94021127	150768	5007	170340	6451	170342	2848A279	090225
94175159	100657	5007	170773	6451	170592	3028666	090254
		5007L	171980	6457	170643	5836B100	090404

OE No.	HC-CARGO	OE No.	HC-CARGO	OE No.	HC-CARGO	OE No.	HC-CARGO
PEUGEOT							
0242.12	181005	494551	150098	597088	150614	92515667	160424
0242.18	180950	5414813	100262	597091	150608	9251586780	160424
0242.26	180954	5471660	070053	597098	150653	9251586980	160424
0242.30	180953	5906079	100663	597099	150520	9401906138	AS301
0242.36	180950	592789	150058	5970A8	150522	94531104	150057
0242.43	180953	594525	150055	5970A9	150634	9453130480	150057
0242.46	180875	594533	150055	5970C0	150614	9456130480	150057
0242.49	180954	594539	150055	5970C1	150614	95 494 924	181584
024246	180875	594545	150057	5974555	150057	9549299580	160423
1131.09	150796	594551	150098	5981.42	161737	95493206	100511
1131.09	150809	594554	150379	598110	160423	95493258	181015
1131.98	150759	594555	150057	598111	160424	95494924	181584
1131C7	150759	594560	150055	598113	160423	95495591	180953
1131C7	150805	596012	100593	598115	160424	95496621	160353
1131J2	150801	596019	100593	598116	160431	95534787	160423
1131J5	150759	596038	100536	598119	160432	95534788	100511
1131K4	150782	596064	100674	598120	160431	95575783	AS301
1131K9	150793	596065	100674	598121	160436	95579683	180953
1192.W5	181495	596076	100622	598124	160434	95658442	160518
1264.03	181008	596078	100663	598126	160436	96009783	100511
1264.04	181009	596099	100664	598127	160436	9600978380	100303
1264.13	181009	5960E6	100686	598131	160453	9601329480	160354
1264.14	181008	5960E7	100683	598140	161120	96018108	181201
1264.26	181076	5960E9	100593	6434.60	160629	96018110	181194
1264.37	181076	5960F4	100674	644195	160518	96033248	181373
1264.40	181076	5960F5	100533	6441E0	261334	9603682780	181589
126403	181008	5960F6	100663	6441J9	261348	96040821	180785
126404	181009	5960F8	100622	6441K0	261353	96048070	150098
126413	181009	5960F9	100663	655117	160308	9604807080	150098
126414	181008	5960K6	100686	655504	160308	96053749	160431
126426	181076	5960L4	100690	655522	160353	9607312	150379
126432	181089	596118	100566	655533	160282	96073612	150379
126437	181076	596139	100511	655547	160354	9607361280	150379
126440	181076	596140	100511	6555HJ	160265	96076258	100303
1338.10	181373	596153	100511	6555VP	160265	96104689	100511
1338.55	181373	596154	100511	75454205	181156	96117510	160431
133850	180875	596157	100511	75483417	150533	96123564	181064
133857	181395	596158	100511	75491289	181156	9613572480	100541
145059	070053	59622Y	100335	75513845	150058	96138637	181076
145070	070054	59622Z	100335	7563225100	100566	96141677	160432
145205	160354	59623C	100533	7700655787	150796	96141678	100511
1607576780	150629	59623E	100533	7910013785	180950	96165724	100511
160757680	150629	59623H	100541	7910014016	180950	96165734	100335
1618 V3	181591	59623J	100541	7910014017	180950	96165823	160436
1625 09	181584	59624J	100436	7910033931	180731	9616582380	160436
1628 58	181584	59627A	100511	7910035100	150055	96165824	160434
1628 7R	181589	59627F	100533	7910035225	181584	9616582480	160434
1628 J4	181589	59627G	100533	7920076593	160423	9619879180	160570
1628 KN	181590	5962J2	100511	7932564528	100511	96236383	100533
1628 KP	181591	5962J4	100511	7932565492	100566	96252036	160432
1628 L4	181589	5962J5	100511	7932567717	100511	9633214380	100541
1628 LP	181590	5962J6	100511	7932567718	100511	9634131480	150653
1628 NY	181590	5962K5	100511	91 517 978	181584	9635864980	150522
1628 AA	181589	5962R8	100511	91000409	160354	9635884880	150522
1628L4	160424	5962S8	100511	9100040980	160354	9636997880	150520
1906-08	AS301	5962T1	100511	91504912	150055	96381671	192902
1906-13	AS301	5962T3	100511	9150491280	150055	96389858	100533
1920AW	150354	5962T7	100511	9150494480	150055	9639912580	160453
194101	080696	5962W2	100335	9150633880	150055	9640469680	161120
197805	080696	5962W3	100335	9150771880	100511	9670363580	150793
197806	080696	5962W8	100511	9150861080	100511	9671214580	150618
198105	080802	5962X1	100511	91514046	181008	9673062180	160265
198133	080761	5970.80	150520	9151404980	070053	9673062180	160919
2257.22	181156	597010	150395	91514549	180875	9752287580	150055
2257.33	181201	597011	150395	9151586980	160424	97522876	150055
2257.34	181194	597026	150395	91517978	181584	97530125	150055
2257.40	181194	597028	150395	9151797880	181584	9753012580	150055
2257.41	181201	597048	150259	9151819080	070054	9753130180	150057
225744	181194	597049	150555	9151819380	181585	97531304	150057
225740	181194	597053	150252	91519272	180954	9753130480	150057
225741	181201	597060	150259	91521849	100511	97531922	150055
321430650	AS301	597064	150575	91521918	100511	97532831	150055
33781405324	181588	597070	150259	9153571880	181585	9753283180	150055
4534.02	180731	597070	150556	9153664680	100511	97533831	150055
4534.06	180726	597072	150634	9153880680	070053	9806702780	150575
453411	180785	597074	150634	9153880780	070054	9999163554	160354
453421	180785	597075	150653	91541882	160354	AL61406	180634
		597078	150522	9250883280	160423	DM212088	150395
		597079	150522	9250888280	160423	DM21208B	150395

ACCESSORIES

O. E. M. names and numbers are used for reference purposes only.

OE No.	HC-CARGO	OE No.	HC-CARGO	OE No.	HC-CARGO	OE No.	HC-CARGO
PEUGEOT continued				PORSCHE			
E144001	181589	12498LL	171979	13342HD	170450	00004490006	160083
E144003	181590	12499	170336	13342HD	171125	043906091	070053
E144004	181592	12499	170770	13401	171086	046905105	150538
E144005	181584	12499LL	170659	13402	171088	171937503	160265
E144008	181586	12503	171994	13413	171997	191905351A	150075
MKD00066	100511	12503	172033	13445	171996	61660210900	150395
MKD00068	100303	12516	170410	13454	170494	90160250200	150536
MKP00064	100511	12516	170775	13496	170849	90160250201	150917
MKP00065	100511	12569	170009	13496	171090	90161357101	180634
MKP00067	100511	12569	171065	13498	170349	91109417700	181584
MKP00068	100303	12594	170644	13498	170826	91160612300	181584
MKP00069	100511	12594	171093	13498HD	170451	91160623000	180634
ND14365	AS301	12596	170071	13498HD	171078	91179961356	160081
PD14365A	AS301	12597	170612	13499	170452	92860211600	150913
PE70004	150799	12598	170357	13516	171092	92860270601	150098
PE70046	150769	12600	170610	13516	170477	92860612301	181584
PE70055	150760	12601	170611	13516	171108	92860612400	181585
PE70058	150779	12602	170611	13521M	170358	92860612800	181585
		12604	170610	13593	170360	92860612801	181585
		12605	170357	13597	170613	92860810401	070054
		12605	170610	13598	170358	92860810402	070054
		12620	170338	13620	170350	92862817200	160197
		12620	170771	13628	170362	93060612400	181585
		12718	171985	13748	171976	93160620600	181584
		12728	171975	13807	170589	944602115	150526
		12748	171974	13814	170351	94460211500	150526
		12803	171139	13814	170793	94460612500	180875
		12807	170588	13814HD	170454	94460613300	181584
		12814	170339	13814HD	171076	94460613500	181585
		12814	170772	13821	170413	94460613501	181585
		12814LL	171992	13821	170794	94460613502	181585
		12818	170590	13821HD	170455	94460810200	070054
		12821	170340	13821HD	171118	94460810201	070054
		12821	170773	13822	171102	94460810203	070054
		12821LL	171980	13829	170456	94460810204	070054
		12822	170593	13844	170414	94460810205	070054
		12829	170448	13844	171096	94460810206	070054
		12829	171119	13850	170592	94463190500	171171
		12844	170341	13864	171099	94860620300	150769
		12844	171094	13866	171100	95160613500	181585
		12850	170342	13913	170416	95560210100	150635
		12854	170411	13929	170417	95560210103	150635
		12854	171095	13929	170795	95560210105	150635
		12860	170005	13961	170542	95561802800	161739
		12864	170343	13961	171107	96460612401	181586
		12864	171097	13972	170800	96560612600	181585
		12865	170005	13972	171080	96560612601	181585
		12866	170344	13972LL	171532	98660612600	181588
		12866	171098	24356	171084	98660612601	181588
		12875	170509	24362	172073	98660612701	181588
		12886	170951	6336	171469	98660612801	181588
		12886	171953	6402	171998	98660620302	150809
		12894	170726	6445/99	171983	99360207100	150552
		12910	170594	6458	171473	99360270600	150379
		12913	170345	6498	171984	99360611600	181588
		12913	171103	6499	171476	99360611601	181588
		12929	170346	6620	171477	99360611800	181588
		12929	170774	6807	171479	99360611801	181588
		12960	170725	6811	171484	99360612600	181588
		12960	171121	6814	171993	99360612601	181588
		12961	170347	6821	171981	99360612700	181588
		12961	171105	6854	171487	99360612800	181588
		12961LL	170662	6910	171490	99360612801	181588
		12972	170720	6913	171491	99660611800	181588
		12972	171077	6929	171492		
		12972BV	171079	7779	171027		
		12972LL	171117	85122	171133	PURULATOR	
		12972PR	171081	85126	171132	40106N	070188
		12972VP	171137	85410	171613	40222	070214
		13241	171978	9004	170692	40223	070214
		13256	170476	9005	170693	50107	070191
		13256	171106	9006	170694	60107	070191
		13258	170449				
		13258	171072	PIAGGIO		REMY (DELCO)	
		13324	171986	143216	150395	10471917	191304
		13336	170412	639523	181584	10475057	191584
		13336	170836			10488150	191304
		13342	170348			10496048	150239
		13342	170792				

OE No.	HC-CARGO	OE No.	HC-CARGO	OE No.	HC-CARGO	OE No.	HC-CARGO
10496541	150239	6001548079	192569	7700854406	080388	8200517313	100646
10496784	150239	7401269084	150056	7700855358	070053	8200561251	100676
10498156	191304	7401271939	181588	7700855865	100511	8200568671	150505
11505767	191573	7439146108	150496	7700856238	100511	8200670466	150781
13010892	150063	7700100558	100532	7700856789	160438	8200670467	150763
13017433	150062	7700100635	100592	7700863454	160438	8200670469	150788
15-8345	160250	7700100643	150434	7700864987	181585	8200670483	150791
16010892	150063	7700100940	100592	7700866727	160451	8200671271	150781
16017433	150062	7700101969	150414	7700867374	160438	8200671272	150763
1875990	150058	7700101970	150404	7700867408	181590	8200671274	150788
1894322	150058	7700103069A	150404	7700867558C	160461	8200671275	150778
19024930	160403	7700103674	100646	7700869343	180905	8200671278	150792
1978778	150062	7700107177	150505	7700875000	150505	8200671279	150791
1987465	150239	7700107794	160461	7701006410	090016	8200671284	150775
1987466	150239	7700109860	160718	7701010100	AS301	8200671285	150775
1989233	191554	7700111323	100436	7701011757	090015	8200671286	150807
1989649	191307	7700111525	160719	7701021955	150058	8200673257	150790
1989747	150239	7700113357	150505	7701026846	080696	8200682592	100685
210843	210843	7700113357A	150505	7701029762	100511	8200699627	150567
210909	210909	7700115078	160795	7701039387	100511	8200702693	150624
7033103	150064	7700260678	070054	7701039667	150775	8200765882	150505
7954117	180660	7700266296	160168	7701044974	080940	8200970441	150791
830931	150058	7700267774	070054	7701045695	080942	8200970474	150763
93488922	150058	7700273273	181585	7701046058	261352	854269800	150395
9348922	150058	7700273715	181585	7701048387	261354	8548060000	AS301
9439738	191545	7700274008	150433	7701048752	261349	8671004018	100511
D1906	150058	7700414484	160366	7701052674	150770	8933002455	181584
D1951	150064	7700414988	181367	7701052674	150786	9611751080	160431
D1957	150063	7700417970	150807	7701052949	100662	LB618	150917
D1958	150063	7700552370	150395	7701056598	261357	LB618A1S	150917
D1959	150062	7700590793	160316	7701056965	261321	LB618A1SFTOYOTA	150917
D1961	150063	7700631755	150809	7701057555	261336	LB618A1SLB618	150917
D1978	150239	7700655787	150796	7701057806	100662	LB618A2	150917
D1979	150239	7700663363	080388	7701059974	150780	LB618A2FMAZDA	150917
D1980	150239	7700670255	181584	7701062226	261337	LB618A2LB618	150917
D1990	150239	7700673874	100511	7701065086	150582	LB618A2ROTARY	150917
D1993	150239	7700681024	181584	7701206250	261354	LB618LTEZU1283	150917
SU31	180808	7700687710	070053	7701348032	150796	TO 70 895 5	181584
		7700701130	100511	7701348032	150809		
		7700702747	160425	7701348033	150796		
		7700704185	100511	7701348033	150809	ROLLS ROYCE	
		7700708605	181584	7701348194	181008	PB20364	181588
		7700708955	181584	7701348252	150395	UD71214	160366
		7700708960	160352	7701348252	150395	UE73879	181589
		7700715675	160352	7701348734	160438	UE74940	181590
		7700715768	100511	7701348772	180950	UR22163	181584
		7700721268	160354	7701349475	100511	UR26474	181584
		7700722393	070053	7701349943	100511	UT 0095	181588
		7700728637	150340	7701365429	150796	UT0095	181588
		7700728638	150340	7701365430	150809	UT10094	181588
		7700729063	181584	7701402250	150354		
		7700729963	181584	7701414081	100303	ROVER GROUP	
		7700733076	100511	7701414083	100303	17H9452	AS301
		7700737461	150395	7701414086	100511	279000000000	150259
		7700737571	180905	7701414089	100303	37H1581	AS301
		7700738322	150395	7701414162	100511	37H576	AS301
		7700739793	150340	7703597062	192902	37H6214	AS301
		7700739794	150340	7704002224	080390	5141403	AS301
		7700740296	080390	8200012099	100646	516920	AS301
		7700741144	100511	8200026650	150791	517711	AS301
		7700742132	150395	8200051128	150441	78747	AS301
		7700742132	150531	8200052063	181590	78891	AS301
		7700749450	150891	8200062452	150792	78981	AS301
		7700751089	160425	8200084401	150441	833544	AS301
		7700757776	160425	8200141149	150899	ADU9830	100511
		7700761254	150796	8200154186	150505	AUU1649	070053
		7700761254	150809	8200154186A	150505	BAU2445	181148
		7700771825	150775	8200156569	192998	BAU5332	150055
		7700771828	150802	8200208611	150505	ERC8450	100511
		7700777660	150775	8200359627	150763	ERR1304	080696
		7700778780	181191	8200359629	150781	ERR6045	150252
		7700782503	181064	8200359633	150778	ERR6066	100691
		7700790579	160438	8200360911	150624	ERR6566	150252
		7700796048	181064	8200367215	150781	ERR7171	181500
		7700802640	181191	8200367216	150781	ETC8847	100307
		7700807154	160216	8200380267	150505	GCL111	150917
		7700834918	150804	8200405098	150505	GCL139	150917
		7700845214	150804	8200423224	100532	GCL195	150270
		7700851443	160438	8200468645	150404	GCL204	150555
				8200490950	100684	GCL207	150885

ACCESSORIES

O. E. M. names and numbers are used for reference purposes only.

OE No.	HC-CARGO	OE No.	HC-CARGO	OE No.	HC-CARGO	OE No.	HC-CARGO
ROVER GROUP continued							
GPS101	180649	20.024-001	170875	191554	191554	VA07-AP8/C-58A	160537
GPS124	150777	20.104-031	172226	191642	191642	VA07-BP12/C-58A	160799
GPS124	150783	20.104-041	170881	192145	192145	VA07-BP12/C-58S	160597
GPS124	150815	20.196-001	170884			VA07-BP7/C-31A	160906
GPS126	180649	20.196-021	170885			VA07-BP7/C-31S	160588
GPS128	150770	20.196-041	170887	SEV		VA08-AP51/C-23A	160914
GPS131	180649	21.002-021	170893	73503702	150055	VA08-AP51/C-23S	160915
GPS133	180649	21.002-031	170893	SIEM		VA08-BP51/C-23A	160909
GPS137	180634	21.002-071	170895	05879900	160423	VA09-AP12/C-27A	160598
GPS160	150770	21.010-121	171328	06421900	160424	VA09-AP12/C-27S	160601
GPS178	150815	21.010-131	171329	08110900	160425	VA09-AP12/C-54S	160601
GPS182	150770	21.017-121	171196	SIEMENS		VA09-AP8/C-27A	160598
GPS183	150770	21.093-021	171202	17-5607	150055	VA09-AP8/C-27S	160601
GPS184	150815	21.131-001	170943	257612.70-01	150056	VA09-BP12/C-27A	160599
GTR204	180875	21.197-001	170916	5WK0611	150668	VA09-BP12/C-27S	160600
HCJ100110	160436	21.197-011	170917	5WK1636	160297	VA09-BP12/C-54A	160599
LR010687	150583	21.197-021	170916	5WK1640	160297	VA09-BP12/C-54S	160600
LR013275	100683	21.197-031	170917	5WK2205	160374	VA09-BP50/C-27A	160599
MHK 000210	181588	21.197-111	170923	5WK6101	150056	VA09-BP8/C-27A	160599
MHK 000220	181588	21.197-121	170922	5WK6102	150075	VA09-BP8/C-27S	160600
MHK 10023	181584	21.197-131	170923	5WK6105	150056	VA10-AP10/C-61A	160538
MHK 100920	181588	22.028-091	170925	5WK6113	150154	VA10-AP10/C-61S	160536
MHK 100930	181588	22.130-001	171006	5WK6208	150380	VA10-AP10/C-61S	161003
MHK 100940	181588	22.131-011	170927	5WKG222	150175	VA10-AP9/C-25A	160538
MHK 500860	181591	23.030-051	170928	PM3511	160250	VA10-AP9/C-25A	161002
MHK000060	181592	23.056-011	170930	S105548001E	150414	VA10-AP9/C-25S	160536
MHK10004L	181589	24.033-001	170934	S105757001E	150404	VA10-AP9/C-25S	161003
MHK10023	181584	24.056-001	170935	S105757001Z	150404	VA10-BP50/C-25A	160584
MHK100650	181590	24.056-011	170935	S119975001B	150404	VA10-BP50/C-25A	161004
MHK100722	181590	25.011-021	171224	SIMMS		VA10-BP50/C-61S	160737
MHK100800	181500	25.012-011	170936	506791	090244	VA11-AP7/C-29A	160539
MHK100960	181584	80.091-021	171230	SISU		VA11-AP7/C-29A	161000
MHK101070	181495	90.104-001	170975	186-370-0015	160215	VA11-AP7/C-57A	160539
MHK101280	181584	90.104-011	170976	1863700016	160337	VA11-AP7/C-57A	161000
MHK500860	181591	90.131-001	170989	186-370-0016	160216	VA11-AP8/C-57A	160539
NCJ100110	160436	90.131-081	170944	186-911-5410	190766	VA11-AP8/C-57A	161000
NEC100750	150885	95.009-061	171266	ŠKODA → VW		VA11-BP12/C-57A	160587
NJL100030	150236	95009-061	171266	SMART		VA11-BP12/C-57A	161001
NJL100040	150236			0003043V002	150812	VA11-BP12/C-57S	160714
NJW100030	150236	SCANIA		0003100V005	150554	VA11-BP7/C-29A	160587
NUC100280	150761	1320483	160366	1351500180	150886	VA11-BP7/C-29A	161001
NUC100350	150761	1350343	170968	3043V002000000	150812	VA14-BP7/C-34A	160998
PRC1039	181183	1365963	170916	A0011530632	150782	VA14-BP7/C-34S	160999
PRC5020	160424	1365964	170917	A0011531032	150782	VA15-BP70/LL-39A	160907
PRC6574	150547	1365965	170917	A0051537828	150797	VA18-BP10/C-41S	160595
RTC4512	181183	1407909	161035	A1221530032	150782	VA18-BP51/C-41S	160595
UMB10001	181194	1439172	161035	Q0003043V002000000	150812	VA18-BP70/LL-41A	160777
UMB10003	181212	1543731	161035	SPAL		VA18-BP70/LL-41S	160595
UMB100050	181194	1789358	150557	005-A45-02	160510	VA18-BP70/LL-86A	160777
SACHS		192820	080696	006-A46-22	160647	VA18-BP70/LL-86S	160595
1950148000	080691	207783	090076	006-A54-22	160511	VA18-BP71/LL-86A	160777
SAGEM		237722	160216	006-B40-22	160557	VA34-AP70/LL-36A	160739
2526115A	150434	243460	160337	006-B40-22/4	160878	VA34-AP70/LL-36S	160913
2526151A	150433	2573826	150056	006-B46-22	160556	VA34-BP70/LL-36S	160619
SAME		285500	161035	006-B50-22	160512		
26732913	160366	303223	170936	008-A100-93D	160593	SSANG YONG	
286390030	160263	303535	161035	008-A45-02	160483	0000940548	181500
SANDEN		400782	160337	008-B45-02	160649	0001587003	150424
251726	190780	4023149	150098	009-A22-26D	160592	0001587503	150424
252035	190780	4239489	181588	009-A70-74D	160592	0001587503	150578
SAVIEM		4301552	181588	009-B40-22	160594	1621580103	150578
5000242265	090015	4302352	181588	010-A70-74D	160639	STANADYNE	
5121017024	090202	4302360	181588	010-B70-74D	160596	24370A	090242
855454800	080696	4395612	070203	VA01-BP70/LL-36A	160584	33702	090344
SAW		4660171	181588	VA01-BP70/LL-36S	160908	ST26214	080873
10.190-011	170857	4660197	181588	VA04-AP70/LL-37S	160912	ST26387	080926
14.115-011	170865	4660205	181588	VA07-AP12/C-31A	160537	ST28800	081176
14.129-011	170867	543731	161035	VA07-AP12/C-58A	160537	STILL	
20.017-001	171171	619241	170936	VA07-AP12/C-58S	160910	14372	160216
20.017-041	171173	SEIKO SEIKI		VA07-AP7/C-31A	160537	14372	160337
20.017-171	171174	191614	191614	SELTEC COMPRESSOR		14375	190766
20.017-181	171175	190492	190492	191375	191375	4014372	160216
						4014372	160337

OE No.	HC-CARGO	OE No.	HC-CARGO	OE No.	HC-CARGO	OE No.	HC-CARGO
SUZUKI continued							
18213-80G02	181591	38610-85C00	160315	SA-4850	090228	9146937	181585
18213-80G02000	181591	38860-66G00	160432	SA-4899-12	090370	9146945	181585
18213-80G12	181591	38860-66G00000	160432	SA-4899-24	090371	9146952	181588
18213-80G12000	181591			SA-4920-12	090206	9147224	181588
18213-82001	181584	SWF		SA-4921	090228	9158718	181590
18213-83000	181584	402227	160031	SA-4934-12	090225	9176660	150803
18213-83E01	181591	402230	160032	SA-5019	090268	9177213	181395
18213-83E01000	181591	402231	160034	SA-5157	090268	9202575	181590
18213-83E10	181591	511005	180206	SA-5171	090160	9228317	160879
18213-83E10000	181591	511006	180207	SA-5174-12	090111	93177490	150759
18213-83E11	181591	596615	181463	SA-5174-24	090113	9337726	181584
18213-83E11000	181591	596650	181462	SAAB		9357021	180875
18213-83G00	181590	611000	160282	12629037	150588	9367798	070054
18213-83G00000	181590	611008	160403	30520357	150796	9390220	150056
18213-83G01	181590	611009	160308	32000152	181588	9392911	070054
18213-83G01000	181590	611009	160337	4086708	181001	9506379	160197
18213-83G50	181590	611012	160316	4232666	181182	9542861	181395
18213-83G50000	181590	611013	160317	4239042	181585	9543406	181395
18213-83G51	181590	611100	160242	4239489	181588	9544610	150762
18213-83G51000	181590	611101	160244	4301545	181588	S4302352	181588
18213-84D00	181591	611102	160243	4302352	181588	TALBOT	
18213-84D00000	181591	611107	160305	4390266	181585	0057189700	150055
18213-85Z00	181590	611108	160305	4395612	070203	5059822	150395
18213-85Z00000	181590	611111	160315	4504585	150762	5060159	150395
18213-85Z10	181591	611112	160315	4570909	181592	7545420500	181156
18213-85Z10000	181591	611114	160262	4570917	181592	9150589080	150395
18213-86G00	181590	611115	160199	4571477	181592	9150771580	100511
18213-86G00000	181590	611116	160315	4617668	181182	9150771980	100511
18213-86G01	181590	696289	180208	4660163	181588	9152191880	100511
18213-86G01000	181590	896426	180209	4660171	181588	9553478880	100511
18213-86G10	181591	896472	180210	4660197	181588	A50633880	150055
18213-86G10000	181591	SYNCHRO-START		4660205	181588	B515867	160424
18213-86G11	181591	150212C3U1B1S1A	090160	4660445	181588	TELEFUNKEN	
18213-86G11000	181591	150212C7U2B2S7	090224	4660494	181588	318738	150056
18213-86Z00	181591	150224C3U1B1S2A	090161	4660502	181588	333231	150056
18213-86Z01	181591	1502ES12C3U1B2S1	090109	4660585	181395	335622	150056
18213-86Z01000	181591	1502ES24C3U1B2S2	090110	4662359	181588	338738	150056
18550-67G11	100674	1503ES-12A5SUC9SCC28	090268	4770186	150762	339373	150075
18550-73J00	100593	1503ES-12A5SUC9SCG28	090268	4770228	180875	THERMO KING	
1855078E00	100515	1503ES12A5UC5S	090216	4772208	181395	11-7433	090440
18550-79J50	100688	1503ES12A5UC9S	090373	4772307	181395	TORRIX	
18550-84A51	100684	1503ES12S5UC5S	090228	4772349	081129	100063	180731
33370-641311	150377	1503ES12S5UC5S	090228	4773586	181395	100430	180731
33370-64B11	150377	1503ES24A5UC5S	090402	5341391	181395	100677	180731
33370-82032	150160	175124A2U1BS1A	090297	55202374	150759	101312	181156
33400-51K10	150911	200112E3U1B2S2	090168	55353148	181592	103224	181194
33400-62J00	150605	200124E3U1B2S2	090169	55353149	181592	TOYOTA	
33400-65G00	150631	2001ES12E3U1B2S2	090111	55354378	150762	01607-00030	160767
33400-65G01	150631	2001ES24E3U1B2S2	090113	55559824	150803	11176-26010	081212
33400-65G02	150631	SA3405T	090224	5951421	150770	11176-64010	080418
33400-83E00	150605	SA-3742-12	090095	5951421	150786	11177-56010	080419
33400-83E10	150605	SA-3742-24	090099	5959283	181395	11177-64010	080417
33410-52012	150395	SA-3765-12	090097	5960059	150098	11178-56010	080236
33410-58015	150540	SA-3765-24	090101	5962816	150762	18213-73B00	181584
3341064B10	150901	SA-3776T	090216	7503600	150098	19850-0L010	100556
33410-64B10	150901	SA-3799-12	090096	7522402	150796	198500R010	100689
33410-83010	150540	SA-3799-24	090100	7522402	150809	19850-0R010	100689
37800000000000	150768	SA-3800-12	090098	7525751	181587	19850-0W01	100590
37800000000000	150777	SA-3800-24	090102	7530140	181584	1985026021	100689
37800000000000	150783	SA-3991-12	090334	7534795	181584	19850-26021	100689
37800000000000	150798	SA-3999-12	090104	8328551	181584	1985026022	100689
3782067J00000	150763	SA-3999-24	090106	8522310	160265	19850-26022	100689
3782067J01000	150763	SA-4014-12	090103	8522328	150395	19850-27010	100556
37820-73000	180641	SA-4014-24	090105	8533176	160403	19850-30010	100556
3782077E90000	150794	SA-4026-12	090107	8547572	181001	19850-54010	100260
37820-79600	180641	SA-4026-24	090108	8553463	160749	19850-54030	100260
3782080001	150783	SA-4180-12	090199	8573826	150056	19850-54031	100260
3782080G01	150768	SA-4182-24	090200	8573834	150542	19850-54050	100258
3782080G01	150798	SA-4228	090226	8593477	160197	19850-54070	100277
3782080G01000	150768	SA-4527	090281	8980534	150075	19850-54071	100277
3782080G01000	150798	SA-4561T	090373	90569684	150762	19850-54090	100291
37820-82000	180641	SA-4562T	090228	9109182	150796	19850-54120	100516
37820-82001	150815	SA-4564-12	090206	9109182	150809	19850-56012	100280
3782084A00000	150791	SA-4567T	090402	9112459	150796		
3782084A01000	150791	SA-4569-T	090216	9128304	081115		
3782084CT0000	150807	SA4646-24	090267	9132564	181585		
3782086J00000	150759	SA-4668-S	090268	9136284	181585		
37820N86J00	150759	SA-4817-12	090206				

OE No.	HC-CARGO	OE No.	HC-CARGO	OE No.	HC-CARGO	OE No.	HC-CARGO
19850-56021	100256	83530-30040	150794	89465-0C150	181591	89465-28270	181591
19850-56022	100256	8353030041	150764	89465-0C160	181591	89465-28320	181591
19850-64020	100283	8353030041	150768	89465-0C170	181591	89465-28330	181591
19850-64031-B	100283	8353030041	150783	89465-0D030	181591	89465-28340	181591
19850-64033	100283	8353030041	150798	89465-0D040	181591	89465-28360	181591
19850-64050	100514	8353030042	150768	89465-0D070	181591	89465-28430	181591
19850-67020	100429	8353030042	150794	89465-0D080	181591	89465-29415	181584
19850-67030	100429	8353030043	150768	89465-0D110	181591	89465-29495	181590
19850-68020	100282	8353030043	150783	89465-0D120	181591	89465-29505	181591
19850-68030	100256	8353030043	150798	89465-0E010	181590	89465-29755	181584
19850-68040	100280	83530-30050	150768	89465-10020	181584	89465-30100	181584
23654-46010	080458	83530-30050	150794	89465-10060	181591	89465-30170	181584
23654-64010	080457	83530-30051	150764	89465-12270	181584	89465-30180	181591
29313-46010	190815	83530-30051	150768	89465-12280	181584	89465-30390	181591
29364-66010	190820	83530-30051	150794	89465-12320	181584	89465-30420	181591
83530-01040	150794	8353030060	150764	89465-12360	181584	89465-30430	181591
8353002030	150764	8353030060	150768	89465-12400	181591	89465-30450	181591
8353002030	150768	8353030060	150794	89465-12430	181584	89465-30470	181591
8353002030	150783	8353030080	150768	89465-12490	181591	89465-30490	181591
8353002030	150798	8353030080	150777	89465-12510	181591	89465-30530	181591
8353005010	150764	8353030080	150783	89465-12540	181591	89465-30610	181591
83530-10010	150768	8353030080	150798	89465-12590	181591	89465-30630	181591
83530-10010	180641	8353030090	150764	89465-12600	181591	89465-30710	181591
83530-10020	150768	8353030100	150764	89465-12610	181591	89465-30720	181591
83530-10020	150783	8353036010	150764	89465-12620	181591	89465-30730	181591
83530-10020	150798	8353036010	150768	89465-12640	181591	89465-30740	181591
83530-10020	180641	8353036010	150794	89465-12700	181591	89465-32060	181584
83530-12010	150768	8353036011	150768	89465-12740	181591	89465-32140	181584
83530-12010	180641	8353036011	150794	89465-12750	181591	89465-32160	181591
83530-12020	150764	8353060010	150764	89465-12760	181591	89465-33030	181591
83530-12020	150768	8353060020	150764	89465-13020	181584	89465-33050	181584
83530-12020	150783	8353060030	150764	89465-13030	181591	89465-33060	181584
83530-12020	150798	8353060030	150768	89465-13040	181591	89465-33100	181584
83530-12020	180641	8353060030	150794	89465-14200	181591	89465-33120	181591
8353012040	150764	8353060040	150768	89465-16040	181584	89465-33130	181591
8353012040	150768	8353060040	150777	89465-16060	181591	89465-33160	181591
8353012040	150777	8353060040	150783	89465-16120	181591	89465-33170	181591
8353012040	150783	8353060040	150798	89465-17200	181591	89465-33200	181591
8353012040	150798	8353060050	150768	89465-17201	181591	89465-33210	181591
83530-14010	150768	8353060050	150794	89465-19025	181584	89465-33220	181591
83530-14010	150783	83530WA011	150761	89465-19026	181584	89465-33230	181591
83530-14010	150798	8439030011	150764	89465-19525	181584	89465-33260	181591
83530-14010	180641	8864530250	150764	89465-19625	181584	89465-33310	181591
83530-14020	150768	89422-05010	180875	89465-20240	181584	89465-33330	181591
83530-14020	150777	89422-05020	180875	89465-20270	181591	89465-33331	181591
83530-14020	150783	89465-01090	181591	89465-20280	181591	89465-33340	181591
83530-14020	150798	89465-01100	181591	89465-20350	181584	89465-33350	181591
83530-14030	150764	89465-01110	181591	89465-20360	181584	89465-33370	181591
83530-14030	150768	89465-02110	181591	89465-20400	181591	89465-33380	181591
83530-14030	150777	89465-02171	181591	89465-20410	181584	89465-33410	181591
83530-14030	150783	89465-02190	181591	89465-20450	181591	89465-34080	181591
83530-14030	150798	89465-04270	181591	89465-20510	181591	89465-34110	181591
8353014040	150764	89465-04280	181591	89465-20580	181591	89465-34120	181591
8353014040	150768	89465-04290	181591	89465-20610	181591	89465-34130	181591
8353014040	150777	89465-04300	181591	89465-20630	181584	89465-34140	181591
8353014040	150783	89465-05080	181591	89465-20640	181591	89465-34150	181591
8353014040	150798	89465-05090	181591	89465-20660	181591	89465-35250	181590
83530-14050	150768	89465-06010	181591	89465-20670	181591	89465-35580	181591
83530-14050	150777	89465-06020	181591	89465-20680	181591	89465-35600	181591
83530-14050	150783	89465-06040	181591	89465-20700	181591	89465-35660	181591
83530-14050	150798	89465-06050	181591	89465-20710	181591	89465-35670	181591
8353014060	150764	89465-06070	181591	89465-20810	181591	89465-35680	181591
8353014070	150764	89465-06080	181591	89465-20820	181591	89465-36040	181591
8353028010	150764	89465-06090	181591	89465-20830	181591	89465-39226	181586
83530-28030	150768	89465-06100	181591	89465-20840	181591	89465-39405	181584
83530-28030	150777	89465-06120	181591	89465-20851	181591	89465-39415	181584
83530-28030	150783	89465-06130	181591	89465-20860	181591	89465-39465	181590
83530-28030	150798	89465-06140	181591	89465-20870	181591	89465-39485	181590
83530-28030	180641	89465-07040	181591	89465-22180	181591	89465-39495	181590
83530-30010	150794	89465-07050	181591	89465-22250	181591	89465-39505	181590
8353030020	150764	89465-07060	181591	89465-22260	181591	89465-39525	181590
8353030021	150764	89465-07070	181591	89465-22270	181591	89465-39535	181590
83530-30030	150768	89465-07080	181591	89465-24050	181589	89465-39595	181590
83530-30030	150777	89465-08010	181591	89465-24160	181591	89465-39645	181590
83530-30030	150783	89465-08030	181591	89465-24170	181591	89465-39695	181584
83530-30030	150798	89465-08040	181591	89465-24200	181591	89465-39745	181590
83530-30030	180641	89465-08050	181591	89465-24210	181591	89465-41020	181591
83530-30040	150764	89465-08051	181591	89465-24220	181591	89465-41030	181591
83530-30040	150768	89465-0C140	181591	89465-28270	181590	89465-41050	181591

ACCESSORIES

O.E.M. names and numbers are used for reference purposes only.

OE No.	HC-CARGO	OE No.	HC-CARGO	OE No.	HC-CARGO	OE No.	HC-CARGO
TOYOTA continued							
89465-41060	181591	89465-60150	181591	90919-02092	150395	170364-1	191915
89465-42080	181591	89465-60200	181591	90919-02094	150395	170366-1	191916
89465-42090	181591	89465-60210	181591	90919-02097	150395	172127-1	191226
89465-42100	181591	89465-60220	181591	90919-02098	150395	172128-1	191227
89465-42110	181591	89465-60230	181591	90919-02100	150395	172129-1	191158
89465-42120	181591	89465-60250	181591	90919-02101	150395	172130-2	191159
89465-42130	181591	89465-60320	181591	90919-02102	150395	172131-1	191224
89465-42140	181591	89465-60330	181591	90919-02103	150395	172132-1	191225
89465-42150	181591	89465-60370	181591	90919-02104	150395	173706-1	192410
89465-42160	181591	89465-63010	181591	90919-02105	150395	173707-1	192411
89465-42170	181591	89465-63030	181591	90919-02109	150395	175062-1	192786
89465-44040	181591	89465-68010	181591	9091902110	150917	179461-5	192381
89465-44070	181591	89465-68020	181591	90919-02111	150395	179462-3	192380
89465-44080	181591	89465-68040	181591	9091902115	150917	180422-2	191938
89465-45010	181591	89465-68050	181591	9091902116	150917	180433-2	190725
89465-46010	181591	89465-69125	181585	9091902118	150917	180984	192002
89465-47070	181591	89465-80041	181591	90919-02120	150395	182490-2	191025
89465-48020	181591	89465-80048	181591	90919-02121	150395	183024-1	192089
89465-48030	181591	89465-87108	181584	90919-02122	150395	183025-1	192090
89465-48060	181591	89465-87212	181584	90919-02123	150395	189727-1	210851
89465-48070	181591	89465-87707	181584	90919-02125	150395	1-963745-1	192156
89465-48130	181591	89465-97212	181590	90919-02126	150395	1-963746-1	192157
89465-48140	181591	89465-97405	181591	90919-02128	150395	1-966867-1	192502
89465-48170	181591	89620-10090	150157	90919-02163	150266	281934-3	192091
89465-48180	181591	89620-10120	150157	90919-02216	150617	282079-2	192078
89465-48190	181591	89620-12340	150157	9091902217	150894	282080-1	192080
89465-48200	181591	89620-16070	150157	90919-02217	150894	282087-1	192082
89465-48210	181591	90069-32007	192569	9091902218	150894	282088-1	192084
89465-50040	181591	90069-32014	192569	9091902219	150897	282089-1	192086
89465-50060	181591	90080-19005	150549	90919-02219	150897	282090-1	192088
89465-50070	181591	90080-19015	150614	90919-02220	150894	282103-1	192077
89465-50080	181591	90080-19016	150654	9091902226	150897	282104-1	192079
89465-50090	181591	90080-19017	150563	90919-02226	150897	282105-1	192081
89465-50100	181591	90080-19019	150614	90919-02230	150655	282106-1	192083
89465-50110	181591	90080-19021	150663	90919-02234	150654	282107-1	192085
89465-50120	181591	90080-19027	150655	90919-02239	150614	282108-1	192087
89465-50130	181591	90099-18014	080001	9091902240	150663	282189-1	192147
89465-50140	181591	90190-2050	150395	90919-02240	150663	282191-1	192148
89465-50150	181591	90191-02007	150395	90919-02243	150617	282192-1	192171
89465-50160	181591	90919-02004	150395	90919-02244	150617	328394	191501
89465-51020	181591	90919-02006	150395	90919-02247	150662	341001-6	191247
89465-52010	181591	9091902007	150395	90919-02248	150662	341002-6	191246
89465-52020	181591	90919-02008	150395	90919-02251	150645	454100-000	191010
89465-52040	181591	90919-02013	150395	90919-02252	150647	5-1579007-2	210644
89465-52100	181591	90919-02014	150395	90919-02255	150645	539960-1	210918
89465-52110	181591	90919-02015	150395	90919-02258	150647	691091-000	191703
89465-52170	181591	90919-02016	150395	90919-02259	150655	726506-1	211018
89465-52180	181591	90919-02017	150395	90919-02260	150662	726518-1	211017
89465-52190	181590	90919-02018	150395	90919-02262	150614	825414-5	192146
89465-52200	181591	90919-02019	150395	9091902265	150663	825514	210689
89465-52250	181591	90919-02020	150395	90919-02265	150663	827397-2	191544
89465-52280	181591	90919-02021	150395	90919-02266	150617	827572-1	192149
89465-52330	181591	90919-02022	150395	90919-02270	150663	925176	170799
89465-52360	181591	90919-02024	150395	90919-19023	150617	925306-2	170619
89465-52400	181591	90919-02026	150395	90919A2001	150662	925596-1	191551
89465-53010	181591	90919-02027	150395	90919-A2002	150645	925597-2	192155
89465-53020	181591	90919-02028	150395	90919C2003	150647	925613-2	191556
89465-53060	181591	90919-02030	150395	90919C2005	150647	925660-1	191563
89465-53070	181591	90919-02031	150395	90919-T2002	150615	925661-1	191564
89465-53080	181591	90919-02036	150395	90987-02001	160480	926893-3	191092
89465-53090	181591	90919-02037	150395	90987-02004	160480	926894-1	191091
89465-53100	181591	90919-02042	150395	90999-99089	160480	926983-2	191543
89465-53110	181591	90919-02043	150395	CYGS0-65A	150157	929938-1	192176
89465-53120	181591	90919-02046	150395	SU001A1261	100686	929940-1	192175
89465-53130	181591	90919-02055	150395	SU001-A1261	100686	962999-1	193250
89465-53140	181591	90919-02056	150395			967398-000	191009
89465-53150	181591	90919-02057	150395			E74832-000	191702
89465-53190	181591	90919-02058	150395			F40876-000	191701
89465-53200	181591	90919-02059	150395				
89465-53230	181591	90919-02067	150395				
89465-58010	181591	90919-02070	150395				
89465-58020	181591	9091902073	150917				
89465-58050	181591	90919-02076	150395				
89465-58060	181591	90919-02079	150395				
89465-58090	181591	9091902083	150917				
89465-58100	181591	90919-02083	150532				
89465-58110	181591	9091902085	150917				
89465-58120	181591	9091902087	150917				
89465-60020	181590	90919-02088	150395				
				TYCO			
				0-1414168-0	160394		
				108961-000	191011		
				1-1579007-4	210919		
				1-1579007-6	210921		
				1-350344-0	191809		
				1-350345-0	191808		
				1-480672-0	191562		
				1-480673-0	191561		
				151791-2	190726		
				160314-2	190024		
				165008	190973		
				165012	191067		
						UNIC	
						000768702	090020
						004729585	100511
						009928977	090016
						009929742	080696
						061653833	090015
						UNIPART	
						GCL111	150917
						GPS101	180649

OE No.	HC-CARGO	OE No.	HC-CARGO	OE No.	HC-CARGO	OE No.	HC-CARGO
GPS106	180649	245092	150227	698534	261347	836007757	090076
GPS109	180636	245095	150520	698563	261319	836330250	090020
GPS117	180649	245097	150522	698729	261321	836431349	090016
GPS126	180649	245098	150653	698754	261351		
GPS140	180631	245104	150505	698804	261343	VARTA	
GPS141	180636	245105	150433	698806	160879	V357	200779
GPS142	180634	245107	150434	698806	160879	V625U	200778
GPS145	180635	245109	150634	698806	261330		
GPS146	180634	245137	150620	698809	261309	VDO	
GPS147	180641	245142	150508	698816	261357	111-82	150761
GPS149	180658	245149	150612	715016	261314	246.042	160197
GTR115	180808	245164	150656	715023	261305	246001	160197
RTC4512	181183	245180	150574	715031	261346	246075	160197
		245514	150072	715033	261356	246083002006G	160381
UNIVERSAL		245515	150058	715036	261328	246083002012G	150809
01282	191805	245516	150175	715048	261322	246083002014G	150809
090109	090109	245519	150056	715056	261337	246083002014G	160382
090110	090110	245520	150057	715235	261348	745219	160352
090111	090111	245521	150075	715239	261317	804/006/005	180839
090113	090113	245522	150062	715240	261329	X10741002002	160352
090115	090115	245523	150064	715241	261307		
090116	090116	245527	150088	715243	261349	VEGLIA	
090160	090160	245533	150067	715246	261323	06459169917	180631
090161	090161	245534	150154	715261	261345	0968012	180950
090168	090168	245536	150098	715266	261350	1.164.5911.990.1	180634
090169	090169	245537	150165	715268	261338	1.164.5916.991.7	180631
090199	090199	245539	150068	728800	160321	1.164.5916.992.5	180631
090200	090200	245544	150157	728801	160322	1.165.8045.990.4	180945
090210	090210	245550	150236	728826	160325	1.165.8067.990.4	181021
090224	090224	245551	150160	728826	160326	1.165.8072.990.1	181001
090226	090226	245600	160423	728827	160327	1.165.8072.990.8	181009
090297	090297	245603	160424	728827	160370	1.165.8072.991.3	181005
090317	090317	245604	160425	728830	160328	1.165.8073.990.2	181009
090318	090318	245607	160438	728830	160411	1.165.8073.992.7	181005
090348	090348	245609	160431	728831	160329	1.165.9640.990.1	180804
090370	090370	245612	160431	728833	161013	1601	180631
090371	090371	245615	160420	728834	160330	4001	180804
090431	090431	245618	160432	73100122	160423	4504	180945
134686	134686	2526037A	150259	73101002	160423	6704	181021
200618	200618	2526055	150668	73103402	160424	7003	180804
PIN2	191801	2526055A	150668	73104822	160425	7213	181005
PIN5	191855	2526182A	150520	73104902	160431	7301(2)	181001
		2528007	150057	73105002	160424	7302	181009
VALEO		2528008	150055	73506302	160431	7302(2)	181009
03283	160337	2528008A	150055	73506802	160453	8501	180945
03501	160358	254108	150525	73507202	160432		
03523	160337	2595002	150072	819745	181064	VOLKSWAGEN	
03601	160282	2595003	150058	819749	181009	0003933681	180631
03608	160311	2595006	150055	819752	181076	0003940685	100511
040500	170665	2595007	150056	819757	181008	0003961005	181584
067500	170968	2595008	150057	819758	181005	0004318331	181001
102180	160423	2595009	150075	819759	181001	000VT5077	181491
102180M	160423	2595010	150062	819774	181021	0025421319	160282
102696	160424	2595011	150064	C18P	100303	004050016	150227
105857	160423	2595013	150088	CD328	150612	004050104	150227
141500	170602	2595016	150175	CD331	150259	004435008	180875
167600	170917	2595022	150067	CD440	150668	005566119	181212
167700	170923	2595023	150154	CD604	150057	00A905105	150424
168100	170922	2595026	150165	CD856	150055	00A905A105	150424
168270	170917	2595028	150068	CD862	150072	01E941521	181194
168340	170916	2595033	150157	CD863	150058	020941521A	181148
168350	170916	575786	161067	CD864	150380	020945415A	181212
168360	170917	643501	160403	CD867	150056	021 906 265	181589
168590	171098	643507	160081	CD868	150057	021905106	150516
192405	192405	643508	160081	CD869	150075	021905106A	150516
210843	210843	643512	160403	CD870	150062	021906265	181589
210909	210909	643523	160337	CD871	150064	021906265AD	181588
210948	210948	643817	160453	CD873	150088	021906265AF	181588
2256030	150612	643822	160216	CD879	150067	021906265AL	181588
2256037A	150259	698046	160518	CD880	150154	021906265B	181586
2256040A	150259	698215	261327	CD883	150165	021906265BN	181588
230858	230858	698216	160620	F950165U	190766	021919081A	180634
245010	150395	698217	261306	W962011T	160511	021919081B	180634
245040	150259	698262	261308			021919081C	180634
245047	150395	698277	261352	VALMET		021919081C	180635
245057	150668	698364	261354	110180	090016	022905100B	150635
245058	150917	698381	160631	113700	080696	022905100E	150635
245059	150395	698382	261325	136760	090076		
245068	150891	698402	261340	836007756V	090016		

ACCESSORIES

O. E. M. names and numbers are used for reference purposes only.

OE No.	HC-CARGO	OE No.	HC-CARGO	OE No.	HC-CARGO	OE No.	HC-CARGO
VOLKSWAGEN continued							
022905100H	150635	038907281D	161738	06A906433K	150470	078906265N	181592
022905100L	150635	038919081A	180688	06A906433L	150470	078906265P	181592
022905100P	150635	038919081B	150772	06A906433N	150470	078906265T	181592
022905100S	150635	038919081B	150773	06A906461	181491	078906265AA	181592
022905100T	150635	038919081C	150769	06A906461E	181491	078919501C	181400
022905715	150635	038919081D	150769	06A919081	150773	079 906 265	181591
022905715B	150635	038919081H	150769	06A919081A	150779	07K905715	150656
023 906 262	181592	038919081K	150769	06A919081C	150760	07K905715A	150656
023906205H	181585	038919081M	150772	06A919081D	150779	07K905715B	150656
023906265H	181585	038919081M	150773	06A919081E	150779	07K905715D	150656
025 906 265	181584	039 906 265	181584	06A919081F	150779	07K905715E	150656
025906041	180875	039906265	181584	06A919081J	150779	07K905715F	150589
025906041A	180861	03C919081	150771	06B905115G	150508	07K905715F	150656
025906265	181584	03D905115	150513	06B905115H	150508	07K905715G	150656
025906265B	181587	03D905115A	150513	06B905115J	150508	085941521	181148
0269190811	180635	03D905115B	150513	06B905115L	150508	105094200	180626
027919501	180839	03D905115C	150513	06B905115M	150508	110094203	180634
028903556	192569	03D905115D	150513	06B905115N	150508	110914010	150395
028905115B	150917	03D905115E	150513	06B905115P	150508	113914010	150917
028915000B	150395	03D905115F	150513	06B905115Q	150508	113919081	180634
028915000B	150531	03D905115G	150513	06B905115R	150508	113945515H	180791
028919081	180634	03D905715A	150513	06B905115S	150508	115094200	180634
028919081A	180634	043905115A	150395	06C 906 265	181592	115915080	150215
028919081B	180634	043905115C	150395	06C905115F	150636	115939031	181158
028919081D	180634	043905115C	150530	06C905115G	150636	115939070	180726
028919081D	180694	043906091	070053	06C905115H	150636	12141244089	150056
028919081H	180634	045906461	181491	06C905115J	150636	12141244191	150056
02K945415C	181456	046130219A	080803	06C905115K	150636	141951253B	160282
02K945415D	181456	047905104	150616	06C905115L	150636	161949111	171153
02T945415	181456	047905104A	150620	06C905115M	150636	161949117	171153
030 906 265	181585	047905104B	150620	06C906265	181592	171905115	150529
030906265AP	181586	047905115	150590	06C906265A	181592	171905115A	150535
030906265BK	181588	047919081	150795	06C906265E	181592	171911161E	160420
030906265F	181585	048 906 265	181585	06D905115B	150657	171911261	160420
030906265G	181585	0489051051	150252	06D905115C	150657	171911261D	160421
030906265P	181585	049919501	180839	06D905115D	150587	171911261E	160421
030906265R	181586	0499195011	180839	06D905115J	150657	171919521F	180949
030919081B	150799	04E919081A	150800	06D905115K	150657	171937503	160265
030919081C	150799	050 906 265	181584	06D919081B	150811	171955651	160197
032905106	150435	050906265	181584	06E905115	150657	175919501	180839
032905106A	150435	051906265E	181584	06E905115A	150657	191205351B	150075
032905106B	150435	052905105	150395	06E905115B	150657	191905351	150075
032905106D	150435	056919081B	180634	06E905115C	150657	191905351A	150075
034906265A	181589	056919081B	180635	06E919081G	150814	191905351B	150075
034906265B	181585	056919081C	180635	06F905115	150656	191905351C	150075
034906265D	181587	056919081E	180658	06F905115A	150656	191906383C	161121
035 906 265	181584	058905101	150428	06F905115B	150656	191911261A	160421
035133533A	181584	058905105	150428	06F905115C	150656	191911261C	160421
035905105A	150543	058906265V	181592	06F905115F	150587	191927841	160403
035906265	181584	059905105B	150529	06F905115F	150656	191951113B	160658
035906265A	181584	059919081	180634	06H905115B	150589	191951113D	160658
035906265C	181584	059919081D	150814	06H919081	150800	191951221	160712
035919521A	180949	059919081G	150814	06H919081A	150800	191951223	160712
036905100A	150509	059919501A	181400	06K919081	150800	191955531	160749
036905100B	150509	059963319	100538	077906262C	181592	191959481C	181126
036905100C	150509	059963319A	100538	077906262G	181592	1H0951113A	160658
036905100D	150509	059963319E	100673	077906265A	181587	1H0951113C	160658
036905715	150509	059963319H	100538	077906265AD	181592	1H1819021	160591
036905715A	150509	061198552	AS301	077906265AE	181592	1H1819021	261341
036905715C	150509	061919081	180634	077906265AF	181592	1H6955651	160378
036905715E	150509	0681274051	080696	077906265D	181588	1J0906381A	160637
036905715F	150509	068130219	080390	077906265E	181588	1J0945511A	181369
036905715G	150509	068908061	100512	077906265H	181592	1J1819021	261308
036919081A	150760	068919081	150789	077906265J	181592	1J1819021C	261308
036919081B	150760	068919081A	180688	077906265K	181592	1J5955651	160379
036919081C	150760	068919081D	150789	077906265L	181592	1J6955651	160683
036919081D	150760	06A904461L	181491	077906265R	181592	1J0945511B	181369
037906265B	181585	06A905097	150641	077906265T	181592	1J0945511C	181369
037906265C	181585	06A905097A	150641	077906265AA	181592	1J0945511D	181369
037906265E	181585	06A905104	150641	078 906 265	181585	1K1819015	261309
037906265F	181585	06A905115	150508	078905104	150887	1K1819015J	261309
037906265G	181585	06A905115A	150508	078905104A	150887	211905351	150056
037906265H	181585	06A905115B	150508	078906265	181585	211905351A	150056
037906265S	181586	06A905115D	150508	078906265C	181588	211905351B	150056
037919369	180986	06A906262AK	181592	078906265F	181588	211905351D	150056
038198051B	090441	06A906262AL	181592	078906265G	181588	211905351E	150056
038903093	192586	06A906262AS	181592	078906265H	181588	251906091	070053
038906461B	181491	06A906433B	150470	078906265J	181588	251919501A	180848
038907281C	161738	06A906433G	150470	078906265L	181588	251919501D	180848

OE No.	HC-CARGO	OE No.	HC-CARGO	OE No.	HC-CARGO	OE No.	HC-CARGO
251959481G	181121	68919081	150789	N10213002	100512	1348600	160400
251959481K	181121	6A919081	150773	N10424901	192798	1363438	160458
251965561B	070192	6A919081A	150779	N10424902	192799	1367776	150387
2D0911253	160447	6A919081C	150760	N10424903	192800	1378123	181587
2D1959101	261323	6A919081E	150779	N10424905	192803	1378504	181034
2D0955651A	160197	6N0905104	150227	N10424906	192804	13785043	181034
2E0937099	160403	6N0951101	160658	N10579201	100527	1383966	150496
2R0906433D	150451	6N1819021	261332	N10579202	100527	1389939	150056
3059060591	160352	6Q1819015	261307	N10579802	100625	1542319	100284
311919081A	180634	6Q1819015C	261307	N10579803	100682	1542411	100284
312939030	181158	6Q1819015E	261307	N10579805	100682	1565598	180399
321191261C	160422	6Q1820015	261329	N10591601	100681	1577794	170936
321906059D	160374	6Q1820015C	261329	N10591602	100624	1587794	170936
321906059E	160374	6Q1820015E	261329	N10591603	100624	1606877	180660
321906059F	160374	6Q1820015G	261329	N10591604	100681	1606877	180660
321906059G	160375	6Q1820015H	261329	N10591608	100681	190990	080696
321906059H	160372	6U0919501	180875	ND10420201	AS301	20002023560	170936
321911261	160420	6U0945515	180726	SE0219470001	180839	20200000	160282
321911261C	160422	6U0945515A	180726	SE021947000I	180839	2023560	170936
321955531A	160749	6U0959481	181126	SE022119900B	AS301	20390648	161035
32905106	150435	6U0959481A	181126	SE022942000A	150809	20401001	160337
333955651	160381	701819167	261344	SE127952000A	180726	20513343	150468
357820021	160513	7E819021A	261326	SE127952600A	181001	20732168	190766
357905104	150227	7H1819021A	261326	SE141947000A	180945	21232	160308
357906381A	160637	7H1819021B	261326	X039416000	150056	21232	160337
357911253	160460	7L0820021D	261355	X03952640	180875	21235	160337
357911253A	160459	7L0820021Q	261355	X03952671	160353	21255974	161035
357919501A	180883	7M0906265C	180285	X039678360	150056	2223608	160401
357955531	160749	7M0951253C	160919	X039416000	150543	2223639	160400
35906265D	181587	7N0951253	160282			233379	080696
36905715	150509	8010451	150892	VOLVO		236628	AS301
36919081C	150760	8010494	150888	00034470062	160416	238364	090202
38919081	150769	8010620	150906	11033954	090281	239235	090202
38919081D	150769	8010625	150889	11110030	090267	241380	090016
3933680	150809	8010626	150902	11806280	160282	243083	090020
3939214	150395	8010759	150911	1219142	181584	243488	080696
3940980	150809	811905115	150508	1257137	180635	244002	090020
3953081	150543	857951253	160751	12571378	180635	244391	090020
3962745	150395	867905104	150227	1257141	100512	244825	090315
3B0951221	160712	867905104A	150227	1257147	080390	272484	150784
3B0951223	160712	893820021	160513	1257216	180839	285211	070054
3B0955531	160749	893820021	261312	1257889	100511	285227	160352
40100025	150227	8A1820021	261327	1258016	160197	30005080042	190766
411941583B	160654	8D0405351	150406	1259832	160197	30617335	181592
411941583C	160654	8D0907557HX	150056	1266085	180660	30617336	181592
431951253H	160282	8D0951253A	160282	12660855	180660	3062252	181591
431955651	160197	8D1820021	261310	12660858	180660	30637520	181591
437955651	160197	8D1820021A	261311	1270535	181588	30637521	181591
443906059	160374	8D2820021	160620	1271576	181586	30637837	181591
443906059A	160374	8JA001915001	180399	1271939	181588	30650109	181591
443907385	160374	94460613300	181584	1271940	181588	30713417	150581
443907385B	160375	A0025421319	160282	1271955	181588	30725678	100686
443907385C	160372	J8353014030	150768	1271986	181588	30731416	150558
443907385G	160372	J8353014030	150798	1274144	181584	30731419	150558
443907385H	160372	J8353014030	180641	1274367	181584	30735759	150416
443911261	160420	J8353030060	150794	1274746	181584	30777311	100665
443951253K	160282	J853014030	180641	1275602	150671	30777404	080209
443955531	160749	KDWHLO9100	190766	1275610	181588	30872555	160461
477 906 205	181584	KDWHLO9113	160216	1276951	181584	30873658	160461
477906205	181584	KDWHLO9113	160337	1287028	160792	30882369	150775
47905104	150616	KDWHLO9217	180399	1298429	150055	3090909	161719
481945515	180734	N01900911	100512	1306932	070054	31216444	150558
489051051	150252	N01901002	100512	1317809	150056	31316353	150584
4A0905351	150409	N01901005	100511	1317810	150543	31375294	150637
4A0905351A	150409	N01901006	100511	1317820	150055	3171420	160317
4A0949101	171153	N0190811	100512	131-8906	081004	3205207	160197
4A0955651	160681	N0190812	100512	1324750	180660	32112047	181073
4A0955651B	160682	N0190814	100512	13247507	180660	32772047	181073
4A0959101A	160710	N0190971	100512	1326730	160352	3285227	160352
4D0905351	150406	N0191001	100512	13323969	180875	32866410	181077
4E0907282A	161739	N0191002	100512	13325840	150098	3294064	150531
4H0951253A	160282	N0191005	100512	13336679	070054	32940645	150395
4O0905351	150406	N0191006	100512	1336137	150544	33420043	150796
52905105	150395	N10140101	100436	1336679	070054	33432378	150802
535905115	150579	N10140102	100436	1346071	150528	33434275	150775
58905101	150428	N10140103	100436	1347003	150784	3345280	AS301
58905105	150428	N10140104	100436	1347003	150810	33452806	AS301
620805104	150227	N10140105	100436	13470034	150784	34470062	160416
62919081	150809	N10213001	100512	1347603	160401	34741140	181191

ACCESSORIES

O. E. M. names and numbers are used for reference purposes only.

OE No.	HC-CARGO	OE No.	HC-CARGO	OE No.	HC-CARGO	OE No.	HC-CARGO
VOLVO continued							
34741143	181191	981189	171377	51299002	160424		
3477646	160197	990053	192902	51299003	160431		
3517501	180839	VOE11806280	160282	51299004	160432		
35175017	180839			51299006	160431		
3523608	160401	WEBCON		51299007	160453		
3523639	160400	13704	210762	51401004	160466		
35254	150395	13710	210763	54201006	160305		
3531075	181589	GAS1	180526	54201030	160305		
3531251	181587			54201101	160242		
3531400	181587	WEHRLE		54201102	160243		
35446913	180734	10485007	190767	54201103	160244		
35453166	150784	10485008	190766	54201108	160314		
3545696	150784	10700005	191026	54212001	160314		
35456961	150784	13003404	160769	54229001	160263		
35601160	160416	13132030	160441	54229002	160263		
36446913	180734	13132031	160442	54401101	160261		
3650116	160416	13132032	160443	54401102	160296		
464901	181584	13132034	160445	54407006	160262		
464947	181584	13132035	160446	54407008	160199		
4864457	171230	13132036	160447	58226606A	160904		
50205003	160295	13132037	160448	58226608	160904		
5080042	190766	13731048	160425	60201001	160297		
51233016	160416	13735045	160438	60201002	160297		
679364	180734	13735052	160425	60215005	160287		
6793640	180734	20200100A	160080	S20200100A	160080		
6820812	160734	20200102	160155	S20201100A	160081		
6842522	181588	20200111	160239	S20201103	160270		
6842619	181588	20200140	160155	S20207100A	160265		
7035254	150395	20201000	160308	S20210100A	160083		
70366376	171230	20201000A	160308	S20400100A	160082		
77989	090076	20201100	160081	S20401100A	160216		
829857	100511	20201100A	160081	S22200117A	160239		
829859	100511	20201101	160403	S29200006A	160363		
834461	150395	20201103	160270	S29201045	160366		
837329	100511	20206100	160267				
840643	100511	20207100	160265	WOODWARD			
8627600	181591	20207100A	160265	1504-12A7U1B1000	090439		
8631582	081115	20210001	160282	1751-12A3U1B1S1A	090210		
8631607	100622	20210100	160083	2300-1505	090431		
8642230	181591	20211100	160316	SA-3527-TX	090439		
8658090	181591	20400000	160307	SA-4092-24	090116		
8670112	181495	20400100	160082				
8670130	181591	20400100A	160082	YANMAR			
8670167	181591	20400102	160473	119653-77950	090228		
8670263	181495	20400111	160240	129155-77801	100522		
8677894	181591	20401000	160337				
870240	090015	20401100	160216	ZEXEL			
870680	100583	20401100A	160216	105210-6560	090440		
870846	100583	20401103	160271	146650-0720	080177		
874368	192902	20407100	160266	146650-0820	080178		
9125371	181588	20410100	160215	146650-1220	080177		
9125372	181588	20411100	160317	146650-1320	080178		
9125580	181588	21203100	160168	150623-4000	080389		
9125582	181588	21403100	160169	150623-4200	080688		
91287714	150791	22200106A	160282	150623-4400	080736		
9135621	181585	22200111	160239	150623-4500	080734		
9135622	181588	22200117A	160239	150623-4900	080388		
9135664	181589	22400111	160240	150623-5200	080689		
9135793	181587	22400117A	160240				
9135794	181585	29200006	160363				
9142045	070054	29200045	160364				
9146108	150496	29201005	160365				
9148494	181584	29201045	160366				
9162987	160458	29201075	160367				
9166020	261335	29401000	160368				
9171429	261335	29401041	160521				
9171479	261339	50205002	160295				
9179101	181588	50205603	160295				
9186934	181592	50237009	160459				
9202719	181588	50237010	160460				
9434225	160792	51216001	160416				
9458187	181591	51216002	160416				
9458189	181592	51216003	160416				
9470011	181591	51216901	160421				
9487221	150558	51223908	160352				
9497345	181592	51223909	160352				
9497347	181592	51233001	160421				
968372	171026	51233006	160421				
968689	171025	51233011	160422				



Index

Edition 2018/2019

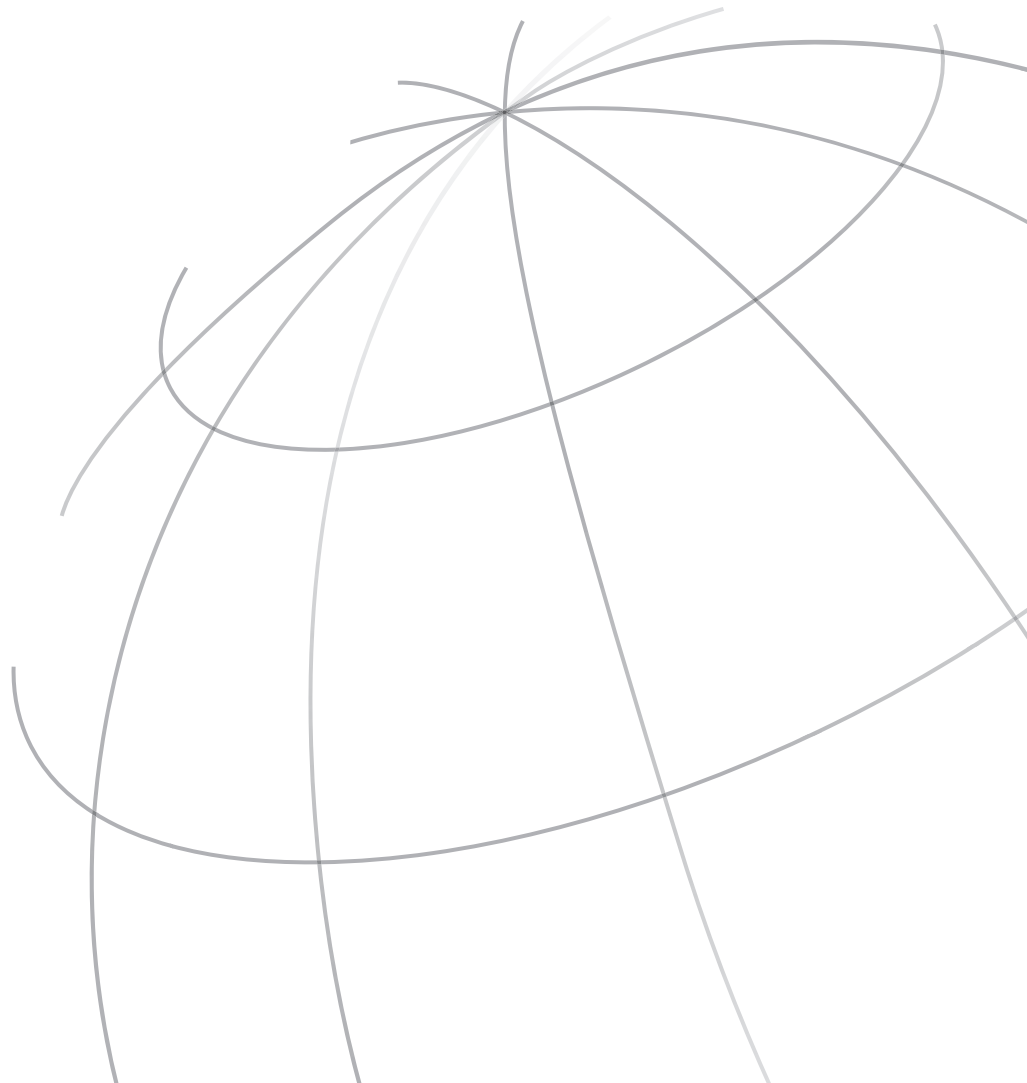

HC-CARGO	Page	HC-CARGO	Page	HC-CARGO	Page	HC-CARGO	Page
040019	298	070160	239	080239	550	080408	587
040077	297	070161	244	080240	550	080410	586
040094	297	070162	242	080241	550	080412	586
040096	298	070172	240	080242	550	080417	586
040149	299	070173	242	080243	550	080418	587
040170	300	070175	242	080245	550	080419	587
040181	297	070177	243	080246	550	080420	267
040182	297	070181	246	080247	550	080423	587
040190	297	070182	242	080250	548	080424	587
040192	298	070184	245	080251	551	080425	586
040193	299	070187	244	080252	551	080426	586
040197	299	070188	244	080253	551	080427	586
040199	298	070191	245	080254	551	080428	586
040200	298	070192	240	080255	551	080430	586
040201	298	070203	240	080256	551	080431	586
040215	297	070206	240	080257	551	080432	586
060058	282	070208	242	080258	551	080433	586
060059	281	070209	242	080259	536	080434	586
060213	281	070214	243	080260	536	080435	586
060214	282	080001	551	080261	536	080436	586
060215	282	080002	550	080262	536	080437	587
060216	280	080003	550	080263	536	080438	586
060219	282	080004	588	080264	536	080439	586
060220	280	080031	587	080265	536	080440	586
060222	280	080033	587	080268	536	080441	586
060223	281	080035	587	080269	551	080442	586
060227	282	080038	253	080270	551	080443	586
060229	282	080046	264	080271	551	080444	586
060233	281	080047	264	080272	551	080446	586
060235	281	080055	265	080273	551	080447	586
060237	282	080059	260	080274	550	080448	586
060241	281	080064	260	080275	550	080449	587
06219	527	080071	260	080276	550	080450	586
070003	243	080097	260	080277	552	080452	586
070004	243	080099	260	080278	552	080453	586
070019	245	080108	548	080279	552	080454	586
070021	245	080109	548	080280	552	080456	586
070032	244	080111	548	080281	552	080457	265
070053	248	080114	254	080282	552	080458	265
070054	248	080161	590	080283	551	080459	266
070055	248	080162	590	080284	551	080465	251
070056	245	080163	590	080285	536	080467	266
070057	245	080164	590	080287	536	080575	551
070058	243	080165	590	080288	536	080582	266
070067	246	080168	261	080289	536	080595	237
070070	246	080170	261	080292	261	080614	254
070077	246	080177	236	080294	261	080627	551
070078	244	080178	236	080295	261	080629	549
070107	244	080188	267	080296	586	080653	549
070134	243	080194	251	080297	536	080654	549
070144	239	080205	261	080340	265	080655	549
070145	239	080207	236	080388	587	080656	549
070147	240	080208	236	080389	265	080657	549
070148	241	080209	236	080390	587	080659	550
070149	241	080210	236	080397	586	080660	550
070150	241	080211	236	080398	587	080661	550
070151	241	080212	237	080402	586	080662	549
070152	241	080213	548	080403	586	080663	549
070153	240	080232	590	080404	587	080664	549
070154	238	080236	587	080405	587	080667	536
070155	239	080237	550	080406	587	080668	536
070156	239	080238	550	080407	587	080669	536

HC-CARGO	Page	HC-CARGO	Page	HC-CARGO	Page	HC-CARGO	Page
080678	550	080865	266	090079	535	090218	232
080679	550	080866	266	090080	535	090222	256
080680	237	080868	267	090081	535	090223	256
080688	586	080873	237	090082	535	090224	233
080689	586	080875	247	090086	264	090225	231
080690	549	080926	237	090087	265	090226	231
080691	586	080929	237	090092	267	090228	231
080692	586	080930	536	090095	227	090235	258
080695	261	080931	536	090096	228	090239	567
080696	586	080933	263	090097	229	090241	567
080701	251	080940	235	090098	229	090242	256
080702	251	080941	235	090099	228	090244	256
080703	262	080942	235	090100	228	090250	258
080705	586	080944	250	090101	229	090251	259
080721	264	080954	247	090102	229	090253	259
080730	262	080955	247	090103	228	090254	259
080732	587	080958	247	090104	228	090255	567
080734	586	080959	247	090105	228	090257	567
080736	587	080960	247	090106	228	090259	568
080738	262	080969	255	090107	229	090267	231
080739	586	080995	237	090108	229	090268	234
080742	262	080996	238	090109	230	090269	567
080744	550	080998	238	090110	230	090273	568
080745	550	081000	238	090111	230	090277	256
080751	548	081002	238	090113	230	090278	256
080752	254	081003	263	090115	235	090281	231
080757	254	081004	255	090116	235	090293	535
080761	586	081006	548	090127	252	090294	257
080763	586	081007	251	090133	567	090297	234
080773	254	081039	247	090136	255	090314	259
080777	586	081040	247	090145	250	090315	259
080783	262	081041	266	090146	251	090316	253
080784	549	081055	586	090147	264	090317	234
080785	549	081058	263	090150	256	090318	234
080786	549	081067	586	090151	257	090319	253
080793	262	081068	586	090153	567	090320	253
080795	550	081111	549	090156	258	090333	259
080802	586	081113	586	090159	263	090334	234
080803	586	081114	586	090160	233	090337	259
080805	251	081115	586	090161	233	090344	257
080809	264	081116	551	090165	267	090345	249
080811	262	081117	235	090166	252	090346	249
080812	551	081129	266	090167	252	090347	253
080815	254	081166	238	090168	233	090348	232
080824	254	081173	586	090169	233	090370	232
080826	550	081176	250	090170	534	090371	232
080828	267	081209	586	090171	534	090372	568
080829	536	081212	586	090172	252	090373	232
080830	536	090015	257	090187	258	090381	253
080831	536	090016	257	090193	248	090391	260
080836	550	090020	257	090194	248	090402	234
080838	550	090027	255	090197	258	090404	249
080839	550	090047	255	090198	258	090409	568
080840	263	090055	255	090199	230	090430	234
080852	263	090061	253	090200	230	090431	232
080854	246	090062	255	090202	258	090439	232
080855	246	090071	252	090203	248	090440	260
080857	246	090072	252	090206	231	090441	257
080858	246	090073	252	090210	233	090442	235
080859	550	090074	264	090212	267	100079	268
080860	550	090076	263	090213	249	100086	269
080863	550	090078	535	090216	231	100177	270

HC-CARGO	Page	HC-CARGO	Page	HC-CARGO	Page	HC-CARGO	Page
100245	268	100529	269	100675	269	150398	310
100246	270	100531	268	100676	268	150401	534
100247	268	100532	269	100678	268	150403	311
100251	268	100533	269	100679	268	150404	323
100252	270	100534	269	100680	268	150406	310
100254	268	100536	270	100681	268	150407	299
100256	268	100537	270	100682	268	150408	299
100257	268	100538	270	100683	268	150409	311
100258	268	100541	269	100684	268	150414	324
100260	269	100544	269	100685	268	150416	304
100261	269	100545	269	100686	268	150417	311
100262	268	100548	268	100687	268	150424	304
100263	269	100555	269	100688	268	150428	304
100271	268	100556	270	100689	268	150433	304
100275	269	100557	268	100690	268	150434	304
100276	270	100559	269	100691	268	150435	311
100277	268	100560	269	100692	268	150441	304
100280	270	100561	270	132804	379	150451	324
100282	270	100563	269	134686	539	150468	324
100283	269	100565	268	135061	552	150470	324
100284	269	100566	268	150037	306	150496	324
100286	268	100578	269	150055	306	150505	304
100287	269	100583	268	150056	306	150508	305
100291	270	100590	270	150057	306	150509	305
100292	269	100592	269	150058	307	150512	311
100295	268	100593	269	150062	307	150513	305
100302	268	100594	269	150063	307	150516	311
100303	269	100595	269	150064	307	150520	305
100306	269	100616	269	150067	307	150521	305
100307	270	100619	269	150068	307	150522	305
100323	269	100622	269	150072	307	150525	305
100324	268	100624	268	150075	308	160002	197
100325	268	100625	268	150088	308	160005	273
100326	268	100627	269	150096	308	160006	273
100327	270	100634	269	150098	308	160019	284
100331	270	100636	268	150100	298	160022	285
100335	269	100639	269	150101	299	160023	285
100336	268	100641	268	150154	308	160024	285
100337	270	100642	269	150157	308	160025	284
100339	270	100644	270	150160	308	160026	284
100352	265	100645	269	150165	309	160028	284
100426	268	100646	269	150169	306	160031	288
100429	269	100650	269	150175	309	160032	288
100432	269	100651	269	150215	309	160033	288
100433	268	100652	268	150227	311	160034	288
100434	268	100653	268	150234	309	160035	284
100435	268	100657	269	150236	309	160036	195
100436	269	100658	270	150239	309	160038	197
100510	268	100659	270	150246	303	160039	198
100511	269	100660	268	150252	303	160042	198
100512	269	100661	269	150259	303	160048	197
100513	268	100662	269	150266	303	160080	449
100514	269	100663	269	150270	303	160081	459
100515	269	100664	269	150340	323	160082	453
100516	270	100665	268	150354	323	160083	449
100518	268	100666	269	150377	309	160115	468
100520	269	100668	268	150378	310	160116	468
100521	269	100669	269	150379	310	160150	287
100522	268	100670	268	150380	310	160155	449
100523	270	100671	270	150384	310	160167	203, 482
100524	269	100673	268	150387	310	160168	457
100527	269	100674	269	150395	306	160169	458

HC-CARGO	Page	HC-CARGO	Page	HC-CARGO	Page	HC-CARGO	Page
160186	291	160325	284	160408	289	160511	271
160187	292	160326	284	160409	398	160512	271
160188	292	160327	284	160410	194	160521	463
160192	296	160328	284	160411	284	160533	195
160195	296	160329	284	160413	296	160534	195
160197	292	160330	284	160414	195	160535	294
160198	292	160332	293	160415	196	160536	275
160199	472	160333	199	160416	270, 474	160537	275
160213	198	160334	199	160417	270, 474	160538	275
160215	453	160337	462	160418	270, 474	160539	275
160216	461	160338	285	160419	270, 474	160541	203
160223	293	160339	285	160420	270, 474	160542	203
160239	451	160341	470	160421	270, 474	160543	204
160240	455	160342	214	160422	270, 475	160544	204
160242	468	160343	215	160423	270, 475	160545	204
160243	469	160346	194	160424	270, 475	160546	204
160244	469	160347	449	160425	270, 475	160551	398
160250	274	160350	466	160426	270, 475	160556	271
160251	274	160352	466	160431	270, 475	160557	271
160252	274	160353	466	160432	270, 476	160558	290
160253	274	160354	466	160434	270, 476	160569	204
160256	285	160355	197	160436	270, 476	160570	464
160257	285	160356	197	160438	270, 476	160571	286
160258	288	160357	289	160441	270, 476	160578	468
160261	472	160358	286	160442	270, 476	160579	202
160262	472	160359	286	160443	270, 477	160580	203
160263	469	160360	293	160445	270, 477	160581	204
160265	450	160361	293	160446	270, 477	160584	277
160266	454	160363	457	160447	270, 477	160586	283
160267	458	160364	457	160448	270, 477	160587	277
160270	459	160365	460	160449	270, 477	160588	277
160271	461	160366	461	160451	270, 478	160592	272
160272	455	160367	461	160453	270, 478	160593	272
160273	291	160368	463	160458	270, 478	160594	272
160276	448	160370	284	160459	270, 478	160595	277
160278	448	160372	466	160460	270, 478	160596	272
160282	450	160374	467	160461	270, 478	160597	278
160287	465	160375	467	160466	464	160598	275
160289	293	160378	293	160468	452	160599	278
160290	289	160379	293	160469	270, 479	160600	278
160291	289	160380	294	160470	467	160601	275
160292	289	160381	294	160473	454	160610	186
160293	289	160382	294	160474	470	160611	191
160294	398	160383	294	160475	470	160612	191
160295	466	160386	294	160477	452	160613	191
160296	472	160387	200	160478	455	160619	278
160297	464	160388	200	160480	450	160622	274
160300	398	160389	200	160481	194	160626	275
160305	469	160390	201	160482	194	160627	211
160306	200	160391	201	160483	271	160628	284
160307	454	160392	201	160484	286	160629	295
160308	459	160393	195	160485	286	160630	295
160311	450	160394	462	160486	286	160632	198
160312	469	160395	287	160487	286	160633	284
160313	472	160396	287	160502	203, 482	160635	284
160314	469	160398	215	160503	290	160637	465
160315	470	160399	215	160504	290	160638	284
160316	459	160400	467	160506	290	160639	272
160317	462	160401	467	160507	294	160640	200
160321	284	160402	470	160508	198	160641	284
160322	284	160403	460	160509	449	160642	200
160323	284	160407	473	160510	271	160643	284

HC-CARGO	Page	HC-CARGO	Page	HC-CARGO	Page	HC-CARGO	Page
160644	201	160756	198	160918	457	160993	192
160645	284	160758	284	160919	461	160994	184
160646	200	160761	284	160920	461	160995	189
160647	272	160766	284	160922	452	160996	184
160648	284	160769	456	160923	452	160998	279
160649	272	160771	284	160926	454	160999	279
160650	284	160775	184	160927	465	161000	277
160651	468	160776	189	160928	465	161001	280
160652	449	160777	278	160929	451	161002	277
160653	284	160778	302	160930	193	161003	277
160654	463	160779	303	160931	453	161004	280
160655	284	160783	184	160932	460	161005	184
160658	196	160784	189	160933	458	161006	186
160659	290	160786	321	160934	458	161007	189
160660	204	160787	323	160935	454	161008	465
160661	284	160792	467	160936	455	161009	451
160671	287	160793	184	160937	456	161010	463
160672	192	160795	270, 479	160938	458	161013	284
160674	273	160797	203, 482	160939	458	161014	214
160676	205	160799	279	160940	453	161015	214
160677	295	160802	461	160941	453	161016	214
160679	295	160803	450	160942	460	161017	214
160680	295	160804	460	160944	462	161018	214
160681	295	160805	450	160945	451	161019	214
160682	295	160806	450	160946	453	161020	463
160683	296	160807	454	160947	455	161021	287
160686	296	160808	462	160948	470	161022	291
160688	296	160809	452	160949	471	161023	291
160689	194	160812	457	160950	471	161024	291
160695	300	160823	460	160951	471	161025	291
160696	301	160827	196	160952	473	161026	212
160697	300	160872	302	160953	473	161029	187
160698	300	160873	302	160954	471	161030	187
160699	302	160874	212	160955	473	161032	189
160700	302	160875	212	160956	471	161033	187
160701	302	160876	215	160957	471	161034	189
160702	301	160877	216	160958	473	161035	457
160712	196	160878	273	160959	473	161036	192
160714	278	160880	186	160966	280	161039	185
160716	472	160881	288	160967	292	161040	190
160718	270, 479	160884	193	160970	106, 121, 212	161041	187
160719	270, 479	160888	192	160971	107, 121, 212	161042	211
160720	452	160889	192	160972	186	161043	187
160721	455	160890	454	160973	292	161044	192
160725	290	160897	301	160974	460	161045	211
160727	287	160899	199	160975	456	161046	185
160734	273	160900	199	160976	462	161047	190
160737	278	160901	199	160977	456	161048	185
160739	276	160902	458	160978	456	161049	190
160740	215	160903	451	160979	456	161050	187
160741	284	160904	448	160980	462	161051	185
160742	215	160906	279	160981	463	161052	190
160744	198	160907	279	160982	451	161053	190
160745	284	160908	279	160983	451	161054	185
160746	196	160909	279	160984	459	161055	190
160747	301	160910	276	160985	459	161056	188
160748	284	160911	276	160986	196	161057	188
160749	464	160912	276	160987	196	161058	188
160750	284	160913	276	160988	197	161059	216
160751	467	160914	276	160989	197	161060	216
160753	284	160915	276	160991	205	161061	283
160755	284	160916	192	160992	464	161062	283

HC-CARGO	Page	HC-CARGO	Page	HC-CARGO	Page	HC-CARGO	Page
161063	283	161126	195	170138	156	170401	150
161064	283	161127	188	170139	157	170402	150
161065	283	161580	284	170142	143	170403	148
161066	283	161701	213	170143	143	170405	40
161067	283	161704	210	170144	143	170406	41
161068	283	161705	210	170163	143	170407	152
161069	283	161706	210	170165	143	170410	173
161070	283	161707	210	170169	143	170411	173
161071	283	161710	211	170170	144	170412	164
161072	201	161712	273	170171	152	170413	172
161073	201	161713	211	170208	144	170414	173
161074	202	161714	301	170212	144	170416	172
161075	202	161715	301	170213	144	170417	172
161076	202	161716	300	170237	43	170419	41
161077	202	161717	398	170239	67	170433	157
161078	205	161718	274	170292	40	170435	10
161079	202	161719	274	170293	64	170436	10
161080	201	161720	185	170295	10	170437	10
161081	202	161721	188	170296	10	170438	10
161082	205	161722	193	170308	14	170448	172
161083	205	161723	191	170309	14	170449	164
161084	205	161724	193	170310	65	170450	165
161085	205	161725	193	170311	65	170451	171
161086	206	161726	186	170313	43	170452	170
161087	206	161727	191	170331	172	170454	171
161088	206	161728	186	170332	164	170455	172
161089	206	161729	191	170333	164	170456	172
161090	206	161730	191	170334	165	170460	41
161091	206	161731	193	170335	171	170470	176
161092	206	161732	193	170336	170	170476	172
161093	207	161733	188	170338	174	170477	173
161094	207	161734	211	170339	172	170488	43
161095	207	161735	270, 479	170340	172	170489	43
161096	207	161736	270, 479	170341	173	170490	11
161097	207	161737	270, 480	170342	173	170491	11
161098	207	161738	270, 480	170343	173	170492	15
161099	207	161739	270, 480	170344	173	170493	164
161100	208	161740	270, 480	170345	172	170494	164
161101	208	161888	213	170346	172	170496	164
161102	208	170002	130	170347	172	170505	15
161103	208	170005	173	170348	165	170506	15
161104	208	170006	165	170349	171	170509	177
161105	208	170009	165	170350	174	170512	164
161106	208	170033	142	170351	171	170513	165
161107	209	170069	164	170357	176	170515	165
161108	209	170070	164	170358	176	170525	16, 24
161109	209	170071	165	170359	165	170528	15, 24
161110	209	170093	43	170360	165	170531	41
161111	209	170098	58	170362	164	170534	44
161112	209	170099	58	170364	175	170537	41
161113	209	170100	58	170366	15	170540	11
161114	210	170101	58	170380	176	170541	11
161115	210	170102	59	170387	40	170542	172
161116	210	170103	59	170390	152	170543	15
161117	283	170104	59	170391	153	170545	176
161118	283	170105	59	170392	153	170551	11
161120	270, 479	170106	59	170393	153	170552	124
161121	468	170107	60	170394	149	170562	41
161122	212	170132	65	170395	149	170564	64
161123	212	170135	156	170396	150	170575	174
161124	296	170136	156	170397	148	170579	174
161125	194	170137	156	170398	148	170583	170

HC-CARGO	Page	HC-CARGO	Page	HC-CARGO	Page	HC-CARGO	Page
170588	173	170688	85	170797	153	170941	76, 136
170589	173	170689	83	170798	12	170942	136
170590	173	170690	68	170799	158	170943	87
170591	173	170691	15	170800	166	170944	95
170592	173	170692	167	170802	165	170945	16, 21
170593	171	170693	167	170803	165	170946	80
170594	172	170694	167	170804	165	170948	172
170596	157	170696	164	170805	172	170951	169
170598	11	170698	175	170806	172	170952	73
170599	12	170710	168	170808	172	170964	158
170601	12	170711	168	170809	133	170965	164
170602	107	170712	176	170810	172	170968	115
170603	107	170713	77	170811	165	170970	44
170604	98	170718	165	170812	165	170972	175
170610	176	170720	166	170813	171	170974	66
170611	175	170725	172	170816	174	170975	80
170612	175	170726	169	170822	171	170976	73
170613	175	170727	175	170825	166	170979	44
170616	69	170729	146	170826	170	170980	45
170617	173	170731	173	170827	158	170981	45
170619	157	170732	173	170828	134	170982	45
170621	71	170741	166	170829	134	170983	45
170623	144	170742	167	170830	12	170984	45
170624	144	170746	133	170833	95, 135	170985	87
170625	144	170748	133	170834	76, 136	170986	87
170626	145	170749	176	170835	134	170987	96
170627	145	170750	176	170836	164	170989	76
170628	145	170751	176	170837	166	170990	109
170629	145	170752	176	170843	65	170991	109
170630	145	170753	176	170844	67	170998	109
170631	145	170754	172	170846	86	170999	109
170632	124	170755	176	170847	95	171000	115
170633	124	170756	175	170848	176	171005	22
170635	125	170757	176	170849	171	171006	66
170636	125	170758	176	170850	170	171007	67
170640	124	170759	152	170857	44	171008	68
170641	125	170762	175	170859	44	171009	168
170642	125	170763	157	170865	66	171010	169
170643	576	170768	165	170867	68	171013	88
170644	170	170769	170	170875	72	171014	88
170648	171	170770	169	170880	79	171015	96
170650	22	170771	174	170881	72	171016	96
170651	22	170772	170	170884	79	171019	12
170653	24, 64	170773	171	170885	79	171023	174
170654	23	170774	171	170887	72	171024	174
170657	165	170775	172	170893	107	171025	175
170659	170	170776	170	170895	107	171026	175
170662	172	170777	171	170909	84, 85, 117	171027	172
170664	143	170778	172	170910	85, 86, 115	171028	174
170665	115	170779	172	170916	108	171029	175
170668	124	170782	176	170917	108	171031	175
170670	78	170783	176	170922	108	171032	175
170671	78, 125	170785	176	170923	108	171033	175
170675	145	170788	41	170925	76	171034	168
170676	146	170789	42	170927	76	171035	168
170677	146	170790	157	170928	85	171036	168
170680	22	170791	157	170930	85	171037	168
170681	165	170792	165	170934	84	171038	66
170683	153	170793	170	170935	84	171039	167
170684	173	170794	171	170936	130	171040	178
170685	86	170795	171	170939	86, 136	171042	178
170687	95	170796	171	170940	87, 136	171043	178

HC-CARGO	Page	HC-CARGO	Page	HC-CARGO	Page	HC-CARGO	Page
171044	178	171118	171	171362	69	171487	173
171045	130	171119	171	171363	70	171490	171
171049	134	171120	173	171364	69	171491	172
171050	88	171121	172	171365	70	171492	172
171051	88	171122	172	171366	69	171493	73
171052	89	171123	172	171369	79	171494	13
171053	89	171124	176	171371	170	171495	22
171054	89	171125	165	171372	98	171497	22
171055	89	171128	173	171373	98	171506	113
171056	96	171129	173	171376	23	171507	116
171057	96	171132	169	171377	175	171508	113
171058	96	171133	169	171378	164, 177	171510	76
171059	96	171134	165	171379	174	171513	42
171060	12	171135	167	171380	174	171518	16, 42, 401
171061	13	171136	164	171381	174	171521	116
171062	116	171137	166	171382	175	171528	126
171064	165	171139	173	171383	174	171529	126
171065	165	171140	77	171384	175	171530	126
171066	165	171141	77	171388	175	171532	166
171067	165	171147	77	171389	175	171533	91
171068	164	171148	78	171390	170	171534	91
171070	164	171153	78	171391	172	171536	146
171071	164	171162	97	171392	142	171537	99
171072	164	171164	131	171396	142	171538	99
171073	164	171166	131	171398	171	171540	23
171076	170	171171	73	171399	13	171549	100, 118
171077	166	171173	121	171401	171	171550	118
171078	170	171174	73	171402	170	171554	149
171079	166	171175	78	171403	170	171555	149
171080	166	171196	124	171404	164	171556	149
171081	166	171202	90	171405	164	171561	23
171082	166	171213	90	171407	164, 177	171562	16, 42, 402
171083	167	171224	131	171408	176	171564	46
171084	167	171230	146	171410	176	171565	66
171086	170	171266	98	171411	176	171566	46
171088	170	171280	177	171423	13	171568	150
171089	170	171281	158	171424	13	171570	149
171090	170	171282	158	171425	176	171571	150
171091	170	171283	173	171426	158	171572	149
171092	169	171284	175	171427	158	171573	558
171093	169	171299	110	171428	138	171576	42
171094	173	171302	110	171441	112	171577	13
171095	173	171303	110	171442	112	171587	14
171096	173	171306	110	171443	112	171588	14
171097	173	171307	116	171444	112	171590	23
171098	173	171308	111	171446	116	171591	126
171099	173	171311	111	171447	113	171592	126
171100	173	171312	116	171448	113	171593	126
171102	171	171322	116	171449	46	171597	71
171103	171	171328	90, 111	171451	70	171613	169
171104	172	171329	90, 111	171452	70	171614	23
171105	172	171330	97, 116	171453	159	171617	127
171106	172	171331	121	171455	174	171618	80
171107	172	171332	73	171464	64	171619	46
171108	172	171337	78	171466	64	171620	47
171109	174	171343	79	171469	164	171621	133
171110	174	171345	131	171473	165	171622	131
171111	175	171347	46	171474	165	171624	131
171112	175	171356	137	171476	170	171627	125
171113	165	171359	70	171477	174	171635	121
171114	165	171360	69	171479	173	171636	80
171117	166	171361	70	171484	173	171637	122

HC-CARGO	Page	HC-CARGO	Page	HC-CARGO	Page	HC-CARGO	Page
171638	73	171730	127	171823	131	171886	147
171639	83	171731	127	171824	132	171887	147
171642	24	171732	127	171825	139	171888	147
171644	24	171733	127	171826	140	171889	147
171646	24	171734	127	171827	140	171891	151
171648	25	171735	81	171828	140	171892	151
171657	31	171736	81	171829	140	171893	151
171658	31	171737	132	171830	140	171894	151
171661	25	171738	132	171831	141	171895	152
171662	25	171742	81	171832	141	171896	152
171663	31	171743	122	171833	137	171897	152
171664	31	171744	74	171834	137	171898	147
171665	100, 118	171745	47	171835	82	171899	147
171666	100, 118	171750	139	171836	82	171900	148
171667	100	171751	48	171838	49	171901	148
171668	101	171752	49	171839	82	171902	148
171671	48	171753	49	171840	122	171903	148
171672	48	171755	49	171841	74	171904	25
171673	16	171756	101	171842	82	171905	26
171674	17	171757	101	171843	123	171906	26
171675	31	171758	101	171844	74	171907	32
171676	138	171759	102	171845	47	171908	32
171677	138	171762	38	171846	50	171909	35
171679	138	171763	17	171847	50	171910	35
171680	33	171764	17	171848	47	171912	35
171681	33	171767	139	171849	34	171913	35
171682	38	171769	139	171850	34	171914	36
171683	169	171770	79	171851	34	171915	39
171684	84	171771	122	171852	34	171916	39
171685	86	171772	102	171853	34	171917	91, 115
171686	164	171773	139	171854	35	171918	17
171687	164	171776	139	171855	38	171919	17
171688	165	171777	38	171856	38	171920	18
171689	166	171778	38	171857	39	171921	18
171690	168	171781	38	171858	39	171922	18
171691	166	171782	47	171859	39	171923	18
171695	138	171783	159	171860	82	171924	159
171696	138	171784	159	171861	123	171925	159
171700	114	171788	99, 117	171862	74	171926	26
171701	114	171789	102	171863	141	171927	103, 118
171702	117	171790	102	171864	141	171928	103, 119
171703	117	171791	103	171865	39	171929	103, 119
171704	154	171793	14	171866	141	171930	103, 119
171705	14	171794	167	171867	123	171931	18
171706	125	171795	136	171868	75	171933	26
171709	132	171796	166	171869	174	171935	135
171710	169	171798	23	171870	114, 137	171936	48, 65
171711	169	171800	77	171871	115, 137	171937	68
171712	169	171801	77	171872	135	171938	50
171713	169	171802	114	171873	135	171939	50
171714	132	171803	114	171874	141	171940	50
171715	132	171804	167	171875	142	171941	21
171716	132	171805	153	171876	142	171942	21
171717	74	171811	49	171877	142	171943	26
171718	74	171813	25	171878	150	171944	51
171719	122	171814	25	171879	150	171945	51
171720	122	171816	32	171880	151	171946	51
171721	81	171817	32	171881	151	171947	51
171722	81	171818	134	171882	151	171948	51
171727	48	171820	33	171883	146	171949	52
171728	32	171821	134	171884	146	171950	52
171729	81	171822	91, 137	171885	147	171951	52

HC-CARGO	Page	HC-CARGO	Page	HC-CARGO	Page	HC-CARGO	Page
171952	104, 119	172025	92	172087	27	172153	94
171953	168	172026	92	172088	54	172154	94
171954	159	172027	19	172089	27	172155	95
171955	52	172028	19	172090	27	172156	95
171956	75	172029	19	172091	28	172157	177
171957	18	172030	19	172092	71	172158	177
171958	128	172031	53	172093	71	172159	177
171959	128	172032	53	172094	36	172160	177
171960	128	172033	170	172095	61	172161	177
171961	128	172034	123	172096	62	172162	177
171962	128	172035	123	172097	62	172163	177
171963	129	172036	82	172098	62	172164	177
171964	129	172037	83	172099	19	172165	177
171965	129	172038	75	172100	20	172166	177
171966	129	172039	75	172101	20	172167	177
171967	129	172040	123	172102	72	172168	177
171968	130	172041	83	172103	154	172169	177
171969	130	172042	83	172104	154	172170	177
171970	130	172043	75	172105	54	172171	177
171974	174	172044	75	172106	55	172172	177
171975	174	172045	54	172107	55	172173	177
171976	174	172046	54	172108	28	172174	177
171977	174	172047	93	172109	28	172175	177
171978	174	172048	93	172110	16	172176	177
171979	170	172049	93	172111	166	172177	177
171980	171	172050	93	172112	28	172178	177
171981	171	172051	97	172113	28	172179	177
171982	170	172052	97	172114	20	172180	177
171983	171	172053	63	172115	36	172181	177
171984	170	172054	63	172116	62	172182	177
171985	174	172055	54	172117	85	172183	20
171986	170	172056	54	172118	28	172184	20
171987	176	172057	97	172119	55	172185	64
171988	170	172058	98	172120	55	172186	155, 558
171989	170	172059	71	172121	29	172187	155, 558
171990	170	172060	71	172122	29	172189	156, 558
171991	174	172061	104, 119	172123	29	172190	156, 558
171992	170	172062	104, 120	172124	29	172191	57
171993	171	172063	104, 120	172125	32	172192	67
171994	170	172064	104, 120	172126	55	172193	67
171996	170	172065	106, 120	172127	55	172194	154
171997	170	172066	99, 117	172128	56	172195	36
171998	170	172067	106, 121	172129	56	172196	36
172001	52	172068	94	172130	56	172197	37
172002	133	172069	94	172131	56	172198	37
172003	53	172070	98	172132	56	172199	37
172004	53	172071	98	172133	56	172200	39
172005	57	172072	159	172134	57	172201	62
172007	84	172073	168	172135	57	172202	63
172008	58	172074	174	172136	57	172203	30
172009	133	172075	19	172137	29	172204	30
172010	53	172076	27	172139	29	172205	30
172011	26	172077	60	172140	30	172206	37
172012	26	172078	60	172141	30	172207	37
172013	27	172079	60	172142	30	172208	40
172014	84	172080	60	172143	57	172209	21
172015	99	172081	61	172144	72	172210	21
172016	99	172082	61	172145	20	172211	21
172021	92	172083	61	172149	105	172212	72
172022	92	172084	61	172150	105	172213	403
172023	97	172085	27	172151	105	172214	106,
172024	97	172086	27	172152	105	172215	106, 120

HC-CARGO	Page	HC-CARGO	Page	HC-CARGO	Page	HC-CARGO	Page
172216	135	180121	502	180253	411	180376	42, 399
172217	135	180123	503	180254	506	180377	42, 399
172218	106	180140	500	180255	506	180380	394
172219	32	180141	500	180261	506	180381	393
172220	33	180143	220	180263	506	180382	393
172221	21	180144	417	180265	507	180383	393
172222	33	180147	413	180266	507	180384	395
172223	30	180150	406	180268	507	180385	395
172224	31	180153	410	180269	507	180386	397
172225	31	180154	414	180271	218	180387	397
172226	80	180156	486	180272	218	180390	393
172227	80	180157	399	180273	221	180391	395
172228	40	180158	486	180274	219	180392	395
172229	40	180159	486	180275	219	180395	397
172230	170	180176	489	180276	219	180396	397
180001	417	180177	489	180277	219	180399	401
180007	486	180178	490	180278	219	180400	503
180008	315	180179	490	180285	416	180401	416
180009	315	180180	490	180286	412	180402	409
180010	501	180194	419	180287	401	180403	416
180014	444	180195	419	180288	221	180404	412
180015	444	180196	419	180289	217	180405	418
180016	444	180197	421	180290	222	180526	326
180017	444	180198	422	180293	407	180529	507
180018	499	180199	423	180296	410	180530	393
180021	501	180201	402	180297	415	180531	393
180022	501	180202	220	180298	404	180532	393
180023	501	180203	216	180305	405	180533	395
180025	225	180206	490	180306	406	180534	395
180027	225	180207	490	180307	406	180535	393
180028	216	180208	492	180308	412	180536	395
180029	220	180209	492	180313	217	180537	395
180036	499	180210	492	180314	486	180538	395
180038	398	180211	217	180316	420	180542	394
180039	497	180212	413	180324	225	180543	394
180040	502	180213	404	180325	422	180548	393
180041	225	180214	407	180326	217	180549	395
180043	225	180215	503	180327	405	180550	397
180044	226	180216	217	180329	408	180551	397
180045	224	180218	406	180330	414	180552	397
180048	497	180219	410	180332	405	180554	395
180049	502	180220	415	180333	221	180556	222
180087	216	180221	404	180338	219	180560	423
180088	500	180225	418	180339	226	180561	423
180090	489	180226	419	180340	227	180562	394
180091	500	180227	419	180341	227	180563	394
180092	500	180228	420	180343	444	180568	410
180094	500	180229	217	180344	445	180569	410
180099	489	180230	401	180345	445	180570	415
180100	489	180232	222	180346	445	180571	411
180101	489	180233	222	180347	445	180572	420
180103	502	180238	413	180348	445	180574	405
180104	502	180239	407	180349	422	180575	397
180105	346	180240	410	180350	422	180577	397
180106	346	180241	415	180351	410	180580	396
180107	413	180242	414	180352	412	180581	396
180108	413	180243	409	180353	416	180582	396
180110	406	180247	419	180354	399	180583	396
180111	414	180248	417	180372	418	180584	497
180112	409	180249	408	180373	404	180585	497
180113	401	180251	420	180374	220	180586	497
180115	399	180252	416	180375	220	180587	498

HC-CARGO	Page	HC-CARGO	Page	HC-CARGO	Page	HC-CARGO	Page
180588	498	180905	322	181278	499	181567	504
180589	498	180945	314	181328	396	181568	504
180590	498	180949	314	181329	396	181569	504
180591	498	180950	314	181367	316	181570	445
180592	498	180953	314	181369	316	181571	445
180593	498	180954	314	181373	323	181572	446
180594	499	180959	314	181395	323	181573	446
180595	500	180985	314	181400	322	181574	446
180596	217	180986	315	181456	318	181575	400
180597	487	181001	318	181461	404	181576	408
180598	487	181005	318	181462	492	181577	224
180599	487	181008	318	181463	493	181578	221
180600	487	181009	319	181465	227	181581	420
180601	487	181015	319	181466	414	181582	408
180602	222	181021	319	181467	409	181583	421
180603	223	181034	319	181469	415	181584	324
180604	223	181064	319	181470	411	181585	325
180605	223	181073	319	181471	411	181586	325
180606	405	181076	320	181472	416	181587	325
180607	411	181077	320	181473	412	181588	325
180608	411	181088	320	181474	412	181589	325
180610	415	181089	320	181475	218	181590	325
180611	420	181121	320	181476	223	181591	326
180612	420	181126	320	181477	221	181592	326
180613	418	181147	316	181485	407	181595	227
180614	218	181148	316	181489	419	181596	227
180616	397	181150	317	181494	326	181597	227
180618	499	181156	317	181495	326	181598	226
180619	221	181158	317	181500	326	181599	220
180620	407	181182	317	181501	394	181600	418
180622	405	181183	317	181502	394	181601	400
180624	415	181191	317	181503	394	181602	402
180625	507	181194	317	181504	394	181603	222
180626	312	181197	318	181505	394	181604	407
180627	487	181201	318	181510	408	181605	396
180628	487	181212	318	181516	394	181606	396
180631	312	181233	502	181517	395	181607	488
180634	312	181235	226	181518	225	181608	488
180635	312	181236	226	181519	394	181609	488
180636	312	181237	226	181520	394	181610	488
180641	312	181238	220	181521	394	181611	422
180648	313	181244	224	181540	224	181612	409
180649	313	181245	224	181544	418	181613	218
180658	313	181246	224	181545	380	181614	218
180660	313	181247	223	181546	490	181615	493
180688	313	181249	504	181547	413	181616	400
180694	313	181251	505	181548	399	181617	406
180726	315	181252	505	181549	400	181618	403
180731	315	181253	505	181550	400	181619	403
180734	315	181256	505	181551	501	181620	403
180785	315	181257	505	181552	501	181621	403
180790	316	181258	505	181554	491	181622	403
180791	316	181263	506	181555	491	181623	421
180804	321	181264	506	181556	491	181624	421
180808	321	181270	221	181557	488	181625	421
180820	321	181271	223	181558	488	181626	421
180839	321	181272	503	181559	488	181627	99, 117, 421
180848	321	181273	404	181562	223	181628	409
180861	322	181274	408	181563	422	181629	401
180875	322	181275	399	181564	503	181630	422
180883	322	181276	499	181565	503	181631	400
180893	322	181277	499	181566	504	181632	493

HC-CARGO	Page	HC-CARGO	Page	HC-CARGO	Page	HC-CARGO	Page
181633	446	190008	537	190116	518	190242	392
181634	446	190009	537	190120	517	190248	514
181635	446	190010	537	190122	517	190252	336
181636	446	190011	514	190157	537	190253	389
181637	447	190012	385	190158	537	190254	389
181638	491	190013	385	190159	537	190255	331
181639	491	190014	514	190160	537	190256	337
181640	491	190015	331	190161	537	190257	331
181641	493	190016	330	190162	537	190260	350
181642	493	190017	330	190163	537	190261	350
181643	493	190018	330	190164	537	190262	351
181644	493	190019	330	190165	537	190263	351
181645	494	190020	330	190166	537	190264	351
181646	494	190021	330	190167	537	190265	352
181647	494	190022	330	190168	537	190266	352
181648	494	190023	330	190169	537	190267	352
181649	494	190024	330	190170	537	190268	352
181650	494	190025	330	190171	537	190269	353
181651	494	190026	330	190172	537	190270	334
181652	494	190027	331	190175	518	190272	350
181653	495	190028	331	190176	518	190273	436
181654	495	190029	331	190177	518	190274	427
181655	495	190030	331	190178	518	190275	427
181656	495	190031	331	190179	518	190276	427
181657	495	190032	331	190180	538	190277	427
181658	495	190033	331	190181	538	190278	427
181659	495	190034	331	190182	538	190279	427
181660	495	190035	331	190183	538	190280	427
181661	496	190037	331	190184	538	190283	343
181662	496	190038	331	190185	538	190284	427
181663	496	190039	331	190186	538	190285	427
181664	496	190041	330	190187	538	190286	427
181665	496	190042	331	190188	514	190287	427
181666	496	190043	380	190189	514	190288	427
181667	496	190045	330	190190	514	190289	427
181668	497	190046	330	190191	514	190360	579
181669	405	190048	330	190195	382	190361	579
181670	423	190049	330	190196	382	190362	579
181671	423	190050	330	190197	382	190366	579
181672	501	190051	330	190202	387	190367	579
181675	414	190052	343	190203	387	190368	579
181677	404	190053	428	190211	385	190371	579
181678	400	190054	428	190212	385	190372	580
181679	402	190055	428	190213	383	190373	579
181680	402	190056	428	190214	383	190469	580
181681	402	190057	428	190215	387	190470	580
181687	218	190058	428	190218	389	190474	580
181688	417	190059	428	190220	390	190477	580
181689	417	190060	428	190221	390	190478	580
181690	417	190061	428	190222	390	190479	580
181691	417	190093	534	190223	390	190480	580
181692	408	190094	534	190224	390	190482	580
181743	156, 213, 558	190095	534	190225	390	190492	580
182369	492	190096	534	190226	390	190493	580
182370	492	190097	199, 534	190228	391	190494	580
182371	489	190100	535	190229	391	190495	580
190001	331	190101	535	190230	391	190499	581
190002	433	190110	518	190231	391	190500	581
190004	433	190111	518	190232	391	190506	580
190005	537	190112	518	190235	391	190508	580
190006	537	190114	518	190237	391	190510	581
190007	537	190115	518	190239	392	190511	581

HC-CARGO	Page	HC-CARGO	Page	HC-CARGO	Page	HC-CARGO	Page
190520	584	190676	525	190807	588	190970	517
190521	584	190677	522	190808	588	190971	381
190524	585	190678	522	190809	588	190972	522
190525	585	190680	526	190810	588	190973	331
190527	585	190681	526	190811	588	190974	331
190528	585	190682	526	190812	588	190979	525
190531	582	190683	526	190813	588	190981	525
190536	582	190684	526	190815	588	190984	534
190537	582	190685	524	190816	588	190985	330
190538	582	190686	525	190817	588	190986	521
190539	582	190687	525	190818	588	190987	521
190540	582	190688	525	190819	588	190988	521
190541	582	190689	525	190820	588	190989	521
190542	582	190690	525	190821	588	190990	521
190544	582	190691	525	190822	588	190991	521
190545	583	190693	525	190823	588	190992	521
190546	583	190695	534	190824	588	190993	525
190547	583	190696	522	190826	588	190994	534
190549	582	190697	522	190828	588	190995	534
190550	582	190698	522	190843	350	190996	534
190551	582	190699	522	190845	524	190997	534
190552	582	190700	522	190846	342	190998	534
190555	583	190701	522	190847	522	190999	534
190556	582	190702	522	190866	386	191000	534
190558	582	190703	522	190867	386	191001	437
190561	582	190704	522	190868	335	191002	523
190577	589	190705	522	190870	437	191003	514
190578	589	190706	522	190875	381	191007	348
190579	589	190707	522	190876	381	191008	336
190580	589	190708	522	190899	512	191009	332
190581	589	190709	525	190900	512	191010	332
190582	589	190710	524	190901	512	191011	332
190583	589	190711	525	190902	512	191012	437
190584	589	190716	342	190903	512	191013	533
190587	587	190717	342	190904	512	191014	534
190588	587	190718	342	190905	512	191015	534
190589	587	190719	342	190906	512	191016	343
190590	587	190720	342	190907	512	191025	336
190591	587	190721	342	190908	512	191026	480
190592	587	190722	342	190909	512	191027	522
190593	587	190723	342	190910	522	191028	334
190594	587	190725	336	190911	382	191029	336
190598	589	190726	336	190937	537	191030	341
190599	589	190734	427	190938	537	191043	525
190603	589	190735	427	190948	523	191044	343
190604	589	190736	427	190950	525	191047	343
190605	589	190762	379	190951	522	191048	343
190608	590	190766	480	190952	331	191049	342
190609	590	190767	480	190953	331	191050	341
190610	590	190768	434	190954	523	191051	341
190612	589	190770	434	190956	380	191053	442
190613	589	190772	434	190957	437	191054	438
190614	589	190774	434	190958	518	191055	442
190616	589	190775	435	190959	518	191056	537
190632	590	190776	380	190961	513	191058	525
190633	590	190779	584	190962	513	191060	342
190634	590	190780	584	190964	517	191062	525
190638	590	190781	584	190965	517	191063	534
190666	525	190782	584	190966	517	191064	336
190667	525	190783	584	190967	517	191065	538
190674	521	190787	436	190968	517	191067	331
190675	524	190806	588	190969	517	191069	336

HC-CARGO	Page	HC-CARGO	Page	HC-CARGO	Page	HC-CARGO	Page
191070	352	191186	431	191263	343	191354	588
191071	352	191187	431	191264	343	191355	588
191074	338	191188	431	191265	589	191358	588
191075	337	191189	431	191266	582	191364	546
191076	380	191190	442	191267	582	191365	546
191077	381	191191	330	191270	551	191366	546
191078	338	191192	536	191271	551	191367	546
191079	337	191193	536	191272	551	191368	546
191080	349	191195	533	191273	551	191369	546
191081	348	191196	339	191274	551	191370	546
191082	337	191197	339	191275	551	191371	546
191083	334	191200	336	191276	551	191372	546
191086	524	191201	533	191277	552	191373	546
191087	524	191202	508	191278	552	191374	546
191088	533	191203	508	191279	552	191375	546
191089	335	191204	508	191280	552	191376	546
191090	521	191205	508	191285	590	191380	518
191091	338	191206	508	191287	589	191383	518
191092	337	191207	508	191288	589	191384	518
191093	524	191208	508	191289	589	191387	518
191094	514	191209	509	191290	587	191388	518
191095	525	191210	509	191291	589	191390	547
191126	349	191211	509	191293	580	191391	547
191127	348	191212	511	191294	581	191392	547
191128	514,	191213	511	191296	584	191395	521
191129	334	191214	511	191297	584	191396	521
191130	525	191215	509	191298	584	191397	521
191131	525	191216	509	191299	584	191398	521
191132	526	191218	511	191302	585	191399	521
191133	384	191219	511	191303	585	191400	521
191134	384	191220	510	191304	585	191401	521
191135	525	191221	510	191305	585	191402	521
191136	525	191222	511	191306	585	191403	521
191152	430	191223	511	191307	585	191404	521
191153	430	191224	351	191308	585	191405	379
191154	430	191225	351	191317	582	191406	379
191155	430	191226	349	191318	582	191407	379
191156	430	191227	348	191319	582	191408	380
191157	430	191228	513	191320	583	191409	435
191158	350	191229	513	191321	583	191410	482
191159	350	191237	538	191322	582	191411	340
191160	525	191238	533	191323	582	191412	340
191161	435	191239	537	191325	581	191413	340
191162	435	191244	386	191326	581	191415	334
191163	435	191245	386	191327	581	191416	342
191164	435	191246	335	191329	581	191417	512
191165	435	191247	336	191330	581	191418	525
191166	385	191248	336	191333	551	191419	525
191167	385	191249	428	191335	587	191429	509
191168	339	191250	428	191336	590	191430	588
191169	339	191251	428	191337	587	191433	551
191171	339	191252	428	191339	588	191435	582
191172	339	191253	428	191344	588	191439	585
191175	522	191254	428	191345	588	191442	588
191176	521	191255	428	191346	588	191445	526
191177	521	191256	428	191347	588	191446	526
191178	521	191257	440	191348	588	191447	526
191179	533	191258	443	191349	588	191448	526
191182	534	191259	443	191350	588	191449	526
191183	507	191260	336	191351	588	191450	526
191184	431	191261	336	191352	588	191451	526
191185	431	191262	336	191353	588	191452	526

HC-CARGO	Page	HC-CARGO	Page	HC-CARGO	Page	HC-CARGO	Page
191453	526	191544	338	191644	580	191730	485
191457	587	191545	581	191645	580	191731	486
191458	590	191546	581	191648	588	191732	486
191459	590	191548	587	191650	349	191733	340
191465	428	191549	334	191657	585	191734	340
191466	428	191551	335	191658	583	191735	341
191467	428	191552	591	191660	583	191737	341
191468	428	191553	512	191661	583	191738	341
191469	428	191554	582	191664	428	191739	341
191470	428	191556	337	191666	512	191740	341
191471	428	191557	583	191667	512	191743	485
191472	428	191558	583	191668	512	191744	484
191473	428	191560	588	191669	512	191751	348
191474	428	191561	353	191672	430	191752	481
191475	428	191562	353	191673	430	191753	579
191476	428	191563	338	191677	583	191755	510
191477	584	191564	338	191678	582	191756	382, 512
191478	583	191570	427	191679	392	191762	582
191480	546	191571	427	191680	438	191763	582
191481	551	191572	427	191681	333	191764	341
191484	381	191573	552	191682	332	191765	341
191485	381	191574	526	191683	332	191766	341
191486	584	191575	590	191684	332	191767	485
191489	588	191576	590	191685	332	191768	437
191490	588	191577	590	191686	332	191769	437
191491	587	191579	589	191687	332	191770	582
191494	518	191580	585	191688	332	191771	382, 512
191495	533	191582	583	191689	332	191772	581
191498	381	191584	583	191690	332	191774	438
191499	534	191585	583	191691	332	191775	440
191501	331	191586	582	191692	332	191776	514
191502	587	191592	538	191693	332	191777	524
191505	583	191593	538	191694	332	191789	580
191506	587	191594	538	191695	332	191791	343
191507	509	191595	538	191696	332	191793	526
191508	510	191596	538	191697	332	191794	526
191510	510	191597	538	191698	332	191795	526
191513	585	191613	584	191699	332	191796	526
191515	331	191614	584	191700	332	191798	579
191516	526	191615	580	191701	333	191799	551
191517	526	191616	547	191702	333	191801	340
191518	526	191617	525	191703	333	191805	534
191519	526	191618	525	191704	333	191806	335
191520	526	191619	525	191705	333	191807	334
191521	526	191620	524	191706	333	191808	351
191522	526	191621	524	191708	333	191809	351
191523	526	191623	524	191709	333	191813	589
191524	526	191625	585	191710	333	191814	512
191525	526	191628	430	191711	333	191815	588
191526	526	191629	430	191713	333	191816	551
191527	526	191630	430	191717	483	191817	525
191528	583	191631	430	191718	483	191818	482
191530	583	191632	430	191719	483	191820	389
191531	583	191633	430	191721	483	191821	389
191532	588	191634	430	191722	483	191830	430
191533	582	191635	430	191723	484	191831	430
191534	427	191636	430	191724	484	191832	430
191535	526	191637	430	191725	484	191833	430
191536	580	191638	430	191726	484	191834	430
191538	588	191640	438	191727	485	191854	580
191539	584	191642	546	191728	485	191855	340
191543	338	191643	582	191729	485	191856	341

HC-CARGO	Page	HC-CARGO	Page	HC-CARGO	Page	HC-CARGO	Page
191857	547	191959	513	192073	584	192157	334
191858	547	191960	515	192074	389	192158	481
191859	547	191962	343	192075	388	192159	481
191860	547	191963	343	192076	388	192160	481
191861	547	191964	343	192077	370	192161	482
191862	547	191965	343	192078	370	192163	384
191863	547	191966	343	192079	371	192164	384
191864	547	191967	343	192080	371	192165	428
191865	547	191968	343	192081	372	192166	373
191866	547	191969	343	192082	372	192167	374
191868	587	191970	430	192083	372	192171	375
191869	588	191971	430	192084	372	192172	375
191870	340	191972	430	192085	372	192173	375
191871	340	191973	430	192086	373	192174	333
191872	340	191974	430	192087	373	192175	335
191873	583	191975	430	192088	373	192176	335
191881	518	191976	430	192089	333	192177	345
191882	518	191977	430	192090	334	192178	345
191883	518	191978	430	192091	345	192179	345
191884	342	191983	343	192093	524	192180	339
191885	342	191984	510	192096	524	192181	339
191886	342	191985	338	192099	524	192190	532
191887	342	191987	581	192102	524	192191	532
191888	342	191988	580	192103	525	192192	532
191889	342	191989	387	192104	525	192196	529
191890	342	191990	387	192105	431	192197	529
191891	342	191992	512	192106	431	192204	531
191898	584	191994	512	192107	431	192205	531
191899	583	191996	512	192108	431	192206	527
191900	581	191997	512	192109	431	192207	527
191901	588	191998	512	192110	514	192208	527
191903	590	192002	349	192111	514	192209	527
191913	590	192003	341	192112	514	192210	527
191914	551	192004	341	192114	580	192211	528
191915	338	192005	341	192122	579	192212	528
191916	337	192006	579	192123	579	192213	528
191923	524	192007	342	192127	584	192214	528
191924	524	192008	342	192128	589	192215	529
191927	524	192009	516	192131	546	192216	582
191928	524	192010	516	192132	440	192217	333
191930	521	192013	514	192133	443	192218	510
191936	521	192014	514	192134	342	192222	343
191937	349	192015	514	192135	342	192224	343
191938	336	192036	330	192136	440	192225	343
191939	514	192041	514	192137	440	192226	330
191941	515	192046	582	192138	517	192227	524
191943	514	192047	343	192139	517	192228	585
191944	516	192048	590	192140	335	192229	429
191945	516	192049	429	192142	331	192230	429
191946	516	192050	429	192143	585	192231	429
191947	516	192051	429	192145	582	192234	389
191948	516	192052	429	192146	373	192236	337
191949	516	192053	429	192147	374	192237	337
191950	513	192054	537	192148	375	192239	334
191951	513	192055	441	192149	374	192240	333
191952	513	192057	436	192150	375	192242	343
191953	513	192058	436	192151	376	192248	580
191954	513	192062	587	192152	376	192249	581
191955	513	192063	580	192153	376	192251	580
191956	513	192065	582	192154	376	192252	581
191957	513	192068	514	192155	335	192253	581
191958	513	192072	585	192156	334	192254	582

HC-CARGO	Page	HC-CARGO	Page	HC-CARGO	Page	HC-CARGO	Page
192255	580	192326	432	192417	585	192493	385
192259	521	192327	432	192418	580	192494	514
192260	521	192328	432	192419	443	192495	514
192261	521	192329	432	192420	444	192496	514
192262	521	192330	432	192421	440	192497	514
192263	521	192331	432	192422	441	192498	514
192264	522	192332	432	192423	441	192501	353
192265	522	192333	432	192424	443	192502	374
192267	522	192334	432	192425	581	192503	333
192269	522	192335	432	192427	428	192505	338
192270	522	192336	432	192428	428	192506	338
192271	522	192337	432	192429	428	192508	580
192272	522	192338	431	192430	428	192515	583
192273	521	192344	442	192431	428	192528	333
192274	522	192347	582	192432	428	192529	334
192275	521	192348	589	192433	428	192536	581
192276	521	192352	331	192434	428	192538	432
192277	521	192353	331	192435	428	192539	432
192278	521	192354	331	192436	441	192540	432
192279	521	192355	516	192440	584	192541	432
192280	521	192356	516	192441	584	192542	432
192282	521	192357	516	192442	349	192543	432
192283	521	192358	516	192443	335	192544	432
192284	521	192359	516	192444	582	192545	432
192286	521	192360	517	192445	526	192546	432
192287	521	192361	534	192446	526	192547	432
192288	521	192362	587	192449	330	192548	432
192289	521	192364	583	192450	359	192549	433
192291	526	192366	538	192451	359	192550	581
192292	526	192368	383	192452	359	192552	340
192293	529	192369	383	192453	360	192554	579
192294	529	192371	331	192457	354	192555	525
192295	528	192373	333	192458	354	192557	342
192296	528	192374	334	192459	355	192559	531
192298	431	192375	345	192460	355	192560	531
192299	431	192376	336	192461	356	192565	581
192300	431	192377	335	192462	356	192567	581
192301	431	192379	539	192463	357	192568	581
192302	431	192380	334	192464	357	192569	582
192303	431	192381	335	192465	358	192571	582
192304	431	192383	337	192466	358	192573	335
192305	431	192384	529	192467	354	192574	335
192306	431	192385	529	192468	354	192575	337
192307	431	192386	530	192469	355	192576	343
192308	431	192387	530	192470	356	192578	559, 590
192309	431	192388	530	192471	357	192582	533
192310	431	192389	530	192472	357	192583	533
192311	431	192390	530	192473	358	192586	582
192312	431	192391	530	192474	358	192587	345
192313	431	192398	531	192475	359	192588	580
192314	431	192399	531	192476	359	192591	584
192315	431	192400	383	192477	338	192592	584
192316	431	192401	383	192478	338	192594	584
192317	432	192402	384	192479	517	192595	360
192318	432	192403	384	192480	517	192596	360
192319	432	192404	580	192481	517	192597	361
192320	432	192405	584	192482	517	192598	361
192321	432	192407	580	192483	517	192599	362
192322	432	192410	333	192484	436	192600	363
192323	432	192411	334	192486	337	192601	364
192324	432	192413	582	192488	353	192602	364
192325	432	192416	581	192489	515	192603	365

HC-CARGO	Page	HC-CARGO	Page	HC-CARGO	Page	HC-CARGO	Page
192604	365	192723	533	192832	347	192977	429
192605	366	192724	533	192833	348	192978	429
192606	366	192727	584	192844	528	192979	429
192607	361	192752	580	192859	346	192980	429
192608	361	192753	580	192861	434	192981	430
192609	362	192754	583	192862	434	192982	430
192610	362	192755	538	192864	442	192983	515
192611	363	192758	340	192871	379	192984	583
192612	363	192759	439	192881	526	192985	515
192613	364	192760	430	192882	526	192986	335
192614	364	192762	428	192884	373	192987	368
192615	365	192763	428	192888	388	192988	547
192616	365	192764	428	192889	388	192997	515
192617	366	192765	428	192890	388	192998	335
192618	366	192766	428	192891	388	193000	386
192619	338	192767	428	192902	374	193001	386
192620	338	192768	428	192903	530	193002	423
192621	339	192769	428	192904	531	193003	519
192622	339	192770	428	192905	342	193004	519
192631	438	192771	428	192906	342	193005	519
192632	438	192772	336	192907	342	193006	519
192633	438	192778	580	192908	342	193007	519
192634	439	192779	431	192909	342	193008	519
192635	439	192780	431	192910	342	193009	519
192636	439	192781	431	192911	342	193010	353
192637	439	192782	431	192912	342	193011	382, 512
192638	443	192783	431	192913	342	193012	522
192639	443	192784	431	192914	342	193013	522
192645	333	192786	334	192915	342	193014	522
192646	334	192787	370	192916	342	193015	522
192647	346	192788	367	192917	342	193016	441
192648	380	192789	525	192918	342	193017	367
192651	369	192790	584	192919	342	193018	367
192652	369	192791	429	192920	342	193019	368
192655	370	192792	429	192921	342	193020	368
192656	370	192793	429	192922	342	193021	367
192658	534	192794	439	192923	342	193022	367
192659	532	192795	330	192924	342	193023	368
192660	532	192798	429	192925	342	193024	368
192663	588	192799	429	192926	342	193027	537
192667	587	192800	429	192927	342	193028	537
192672	584	192801	429	192928	342	193029	537
192678	589	192802	429	192932	342	193030	537
192679	589	192803	429	192933	342	193031	537
192681	387	192804	429	192936	447	193032	537
192682	388	192805	429	192937	447	193033	537
192683	370	192808	346	192938	447	193034	537
192685	436	192809	346	192939	447	193035	537
192686	436	192810	346	192940	447	193036	537
192687	441	192811	347	192941	447	193037	537
192694	589	192812	347	192950	331	193038	537
192695	587	192813	347	192951	525	193039	537
192696	587	192814	552	192952	442	193040	537
192700	532	192817	538	192959	447	193041	537
192701	533	192818	538	192960	447	193042	369
192702	533	192820	524	192961	447	193043	369
192703	533	192821	588	192962	447	193044	369
192705	431	192825	330	192963	448	193045	369
192707	552	192828	347	192964	448	193046	513
192720	535	192829	347	192965	448	193047	522
192721	427	192830	347	192975	342	193048	522
192722	533	192831	347	192976	428	193049	522

HC-CARGO	Page	HC-CARGO	Page	HC-CARGO	Page	HC-CARGO	Page
193050	522	193114	366	193207	519	193274	428
193051	522	193115	367	193208	519	193275	428
193052	522	193116	367	193209	519	193276	428
193053	523	193117	368	193210	519	193277	428
193054	523	193118	368	193211	519	193278	428
193055	523	193119	83, 374	193212	515	193279	428
193056	523	193120	340	193213	427	193280	428
193057	523	193121	516	193214	427	193281	428
193058	523	193122	516	193215	427	193282	428
193059	523	193123	516	193216	427	193283	428
193060	523	193124	516	193217	427	193284	428
193061	523	193125	516	193218	427	193285	428
193062	523	193126	516	193219	427	193286	428
193063	523	193127	516	193220	538	193287	428
193064	523	193129	515	193221	538	193288	428
193065	523	193130	515	193222	538	193289	428
193066	523	193131	515	193223	538	193290	428
193067	523	193135	515	193224	538	193291	428
193068	523	193142	515	193225	538	193292	428
193069	523	193151	515	193226	538	193293	428
193070	523	193163	515	193227	538	193294	429
193071	523	193166	387	193231	538	193295	429
193072	523	193167	387	193232	538	193296	429
193073	523	193168	342	193233	339	193297	429
193074	523	193169	518	193234	339	193298	429
193075	523	193170	518	193235	339	193299	429
193076	523	193171	518	193236	339	193300	429
193077	523	193172	518	193237	333	193301	429
193080	523	193173	518	193238	335	193302	429
193081	523	193174	518	193239	533	193303	429
193082	523	193175	518	193240	533	193304	429
193083	523	193176	518	193241	375	193305	429
193084	523	193177	518	193242	333	193306	429
193085	523	193178	518	193243	333	193307	429
193086	523	193179	518	193244	332	193308	429
193087	523	193180	518	193245	332	193309	428
193088	523	193181	519	193247	332	193310	428
193089	523	193182	519	193248	332	193311	428
193090	523	193183	519	193250	337	193312	428
193091	355	193184	519	193251	522	193313	428
193092	355	193185	519	193252	522	193314	428
193093	356	193186	519	193253	521	193315	428
193094	356	193187	519	193254	522	193316	428
193095	357	193188	519	193255	522	193317	428
193096	357	193189	519	193256	513	193318	428
193097	358	193190	519	193257	513	193319	427
193098	358	193191	519	193258	513	193320	427
193099	359	193192	519	193259	513	193321	427
193100	359	193193	519	193260	513	193322	427
193101	360	193194	519	193261	513	193323	427
193102	360	193195	519	193262	513	193324	427
193103	361	193196	519	193263	590	193325	427
193104	361	193197	519	193264	342	193326	428
193105	362	193198	519	193265	444	193327	428
193106	362	193199	519	193266	371	193328	428
193107	363	193200	519	193267	371	193329	428
193108	364	193201	519	193268	371	193330	428
193109	365	193202	519	193269	371	193331	428
193110	365	193203	519	193270	372	193332	428
193111	365	193204	519	193271	372	193333	428
193112	366	193205	519	193272	371	193334	428
193113	366	193206	519	193273	428	193335	428

HC-CARGO	Page	HC-CARGO	Page	HC-CARGO	Page	HC-CARGO	Page
193336	428	193545	429	200669	592	200810	540
193337	428	193547	429	200670	593	200813	544
193338	428	193548	429	200671	593	200828	543
193339	428	193549	429	200672	593	200831	556
193340	428	193550	429	200673	593	200832	556
193341	428	193551	429	200676	593	200833	556
193342	428	193552	429	200684	155	200834	556
193343	428	193553	429	200685	557	200837	155
193344	428	193554	429	200686	556	200838	553
193345	428	193555	429	200687	557	200846	545
193349	354	193556	429	200688	557	200848	543
193350	354	193557	429	200693	593	200850	553
193351	355	193558	429	200698	559	200851	546
193352	355	193559	429	200699	559	200852	546
193353	356	193560	429	200700	559	200853	546
193354	356	193561	429	200701	559	200854	545
193355	357	193562	429	200702	559	200858	545
193356	358	193564	429	200703	559	200869	557
193357	360	193565	429	200706	559	200875	591
193358	360	193566	429	200707	559	200876	591
193359	361	193567	429	200708	559	200877	591
193360	362	193568	429	200709	559	200884	556
193361	363	193569	429	200710	559	200885	556
193362	363	193570	429	200711	559	200886	556
193363	364	193571	429	200712	559	200887	556
193364	364	193572	429	200713	559	200888	556
193365	63	193573	429	200721	540	200889	556
193366	63	193574	429	200722	540	200890	556
193367	63	193575	429	200723	540	200891	556
193368	63	193576	429	200728	155	200892	556
193369	392	193577	429	200734	540	200893	556
193370	392	193578	429	200735	541	200897	556
193371	392	193579	429	200738	542	200898	545
193372	392	193600	481	200739	542	210050	559
193373	481	200004	539	200740	542	210051	560
193374	538	200005	539	200741	542	210052	570
193375	538	200094	539	200742	542	210053	570
193376	427	200127	557	200745	541	210054	570
193377	427	200140	556	200746	540	210121	343
193378	427	200141	556	200747	541	210134	570
193379	427	200142	556	200748	540	210140	553
193380	427	200144	557	200749	540	210141	552
193381	427	200181	154	200766	545	210142	552
193382	427	200300	539	200768	545	210143	552
193383	427	200400	539	200769	545	210144	552
193384	526	200500	540	200771	546	210145	552
193502	585	200526	556	200772	543	210146	552
193530	429	200601	542	200773	544	210147	552
193531	429	200603	556	200774	544	210148	552
193532	429	200618	541	200775	544	210149	552
193533	429	200624	557	200776	543	210150	552
193534	429	200633	591	200777	543	210151	552
193535	429	200635	154	200778	544	210152	552
193536	429	200640	556	200779	544	210153	552
193537	429	200655	557	200787	556	210154	552
193538	429	200659	155	200790	553	210155	552
193539	429	200663	591	200791	543	210156	552
193540	429	200664	592	200792	542	210157	552
193541	429	200665	592	200796	541	210158	552
193542	429	200666	592	200802	544	210159	552
193543	429	200667	592	200805	556	210160	552
193544	429	200668	592	200808	543	210164	552

HC-CARGO	Page	HC-CARGO	Page	HC-CARGO	Page	HC-CARGO	Page
210212	575	210813	559	211053	378	211158	569
210249	537, 559	210818	559	211058	571	211159	569
210567	566	210822	559	211059	571	211160	569
210574	610	210827	520	211065	572	211161	569
210638	343	210828	520	211073	213	211162	569
210639	344	210841	433	211077	213	211163	569
210643	376	210842	433	211081	561	211164*	564
210644	520	210843	560	211083	575	230858	552
210645	520	210845	574	211090	554	253488	557
210661	376	210846	574	211091	577	253489	154
210667	376	210849	520	211092	555	4440X	68
210672	377	210851	377	211094	575	804008	596
210675	377	210853	578	211096	520	804012	596
210686	566	210860	578	211097	576	804013	596
210689	344	210867	566	211101	572	804014	596
210696	344	210868	566	211102	572	804015	597
210699	572	210869	571	211103	574	804017	597
210702	433	210871	571	211106	554	804020	597
210708	577	210872	571	211107	555	804021	597
210709	577	210873	560	211108	555	804022	598
210710	577	210877	560	211109	556	804024	598
210712	577	210878	573	211110	556	804036	598
210713	577	210897	553	211113	571	804037	598
210715	578	210898	554	211114	571	804040	599
210716	578	210899	554	211117	576	804041	599
210723	578	210901	554	211118	576	804048	599
210724	578	210902	555	211119	575	804049	599
210725	578	210903	555	211120	378	804050	600
210726	578	210904	555	211122	576	804054	600
210727	578	210905	579	211123	492, 576	804055	600
210729	578	210909	560	211124	575	804065	600
210740	578	210910	554	211126	573	804068	601
210741	579	210911	555	211127	378	804069	601
210742	579	210912	555	211128	573	804070	601
210743	579	210918	377	211129	561	804073	601
210744	577	210919	377	211130	561	804075	602
210745	579	210921	377	211131	561	804076	602
210747	579	210937	344	211132	561	804077	602
210748	579	210938	344	211133	561	804078	602
210750	578	210939	344	211134	562	804081	603
210751	578	210948	560	211135	562	804085	603
210753	578	210973	345, 378	211136	562	804086	603
210754	578	210977	572	211137	562	804088	603
210755	578	210980	573	211138	562	804089	604
210757	579	210995	566	211139	562	804090	604
210758	570	210996	566	211140	562	804091	604
210759	577	211013	573	211141	563	804092	604
210760	344	211014	573	211142	563	804093	605
210762	572	211017	377	211143	563	804094	605
210763	564	211018	378	211144	563	804095	605
210771	570	211027	577	211145	563	804096	605
210777	565	211028	577	211146	563	804097	606
210778	565	211035	213	211147	563	804098	606
210779	565	211036	213	211148	564	804100	606
210780	565	211040	574	211149	564	804101	606
210781	565	211041	574	211150	564	804102	607
210782	565	211042	575	211151	564	804103	607
210786	565	211045	574	211152	564	804106	607
210789	559	211048	560	211154*		804107	607
210790	559	211049	561	211155	568	804110	608
210791	559	211051	378	211156	568	804113	608
210793	559	211052	378	211157	569	804117	608

HC-CARGO	Page	HC-CARGO	Page	HC-CARGO	Page	HC-CARGO	Page
806011	328	B191651	581				
806015	328	B191792	581				
806020	328	B191867	581				
806030	328	B191944	516				
807002	608	B191945	516				
808014	609	B191946	516				
808015	609	B191947	516				
809002	180	B191948	516				
809003	180	B191949	516				
809004	181	B192009	516				
809005	180	B192010	516				
809009	180	B192093	524				
811001	609	B192291	526				
811004	609	B192292	526				
AS301	249	B192446	526				
B090079	535	B192569	582				
B090080	535	B192881	526				
B090081	535	B230731	583				
B090083	535	H4360	68				
B090084	535	H5360	69				
B090119	535	RT1000	249				
B090148	535	RT1003	249				
B190680	526	RT1005	250				
B190681	526	RT2002	250				
B190682	526	RT2006	250				
B190683	526	RT2016	250				
B190684	526						
B191132	526						
B191306	585						
B191307	585						
B191308	585						
B191325	581						
B191326	581						
B191327	581						
B191328	581						
B191329	581						
B191330	581						
B191380	518						
B191382	518						
B191383	518						
B191384	518						
B191385	518						
B191387	518						
B191446	526						
B191447	526						
B191448	526						
B191449	526						
B191450	526						
B191451	526						
B191452	526						
B191453	526						
B191478	583						
B191494	518						
B191513	585						
B191514	581						
B191523	526						
B191525	526						
B191526	526						
B191533	582						
B191574	526						
B191582	583						
B191643	582						



HC-CARGO is represented worldwide.

For your nearest dealer and full program overview contact one of our offices below:

DENMARK

Tel. 76 14 33 22 · Fax 76 14 32 30
sales.dk@hc-cargo.com
www.hc-cargo.dk

GERMANY

Tel. 02739 403040 · Fax 02739 4030420
cargo@cargo-de.com
www.hc-cargo.de

AUSTRIA

Tel. 0810 202105 · Fax 0810 202106
cargo@cargo-de.com
www.hc-cargo.de

UNITED KINGDOM

Tel. 0115 928 0086 · Fax 0115 928 0033
cargo@cargo-uk.com
www.hc-cargo.co.uk

BENELUX

NETHERLANDS Tel. 076 5019700
BELGIUM Tel. 03-6053128
Fax 0031 (0) 76 5019007
cargo@cargo-nl.com
www.hc-cargo.nl

SWEDEN

Tel. 019-27 88 00
cargo@cargo-se.com
www.hc-cargo.se

SPAIN

Tel. 91 327 9102
cargo@hc-cargo.es
www.hc-cargo.es

FRANCE

Tel. 02 38 49 66 66 · Fax 02 38 49 66 67
cargo@cargo-fr.com
www.hc-cargo.fr

ITALY

Tel. 051 499 8989 · Fax 051 499 8990
cargo@hccargo-it.com
www.hc-cargo.it

POLAND

Tel. 61 8400940
cargo@hc-cargo.pl
www.hc-cargo.pl

All Other Countries

Tel. + 45 76 14 33 00
hc-cargo@hc-cargo.com
www.hc-cargo.com

Your HC-CARGO contact:

For your nearest HC-CARGO dealer
and full program overview visit
www.hc-cargo.com



Your Expert in Parts

